

New! Gas Furnace Limits and Plenum Thermostats

- Direct OEM Replacements
- Economical
- Use 36T Electrical Ratings



SUPCO Part No.	Description	Open °F	Close °F	Board Width	Board Height	Insertion Length	Carrier BDP Bryant Day & Night Payne	Goodman Janitrol GMC	Lennox Air-Ease Armstrong Concord Magic Chef	Rheem Corsair Ruud Weather King	Trane GE	York Borg-Warner Frazier Johnson Luxair
SHL501	L170-40 SPST	170°F	130°F	1.88"	2.8"	3.12"	HH12ZA174A, HH12ZA176A, P331-2203					
SHL502	L180-30 SPST	180°F	150°F	1.88"	2.8"	3.12"	HH12ZA178A	B1370001				
SHL503	L190-40 SPST	190°F	150°F	1.88"	2.8"	3.12"	HH12ZA189, HH12ZB190, HH12ZA193A, P331-2205					
SHL504	L240-40 SPST	240°F	200°F	1.88"	2.8"	3.12"	HH12ZA240, HH12ZA252A, P331-2217					
SHL505	L140-40 SPST	140°F	100°F	1.88"	2.8"	1.87"	HH12ZB140					025-29041-005
SHL506	L170-40 SPST	170°F	130°F	1.88"	2.8"	1.87"	HH12ZB170			47-25349-02	SWT1258	
SHL507	L140-30 SPST	140°F	110°F	1.88"	2.8"	3.12"	HH12ZA140		87F16			025-29041-005
SHL508	L190-20 SPST	190°F	170°F	1.88"	2.8"	3.12"	HH12ZB190, HH12ZA193, HH12ZA189, P331-2005	B1370913		47-21711-03	SWT1260	025-29041-006
SHL509	L240-30 SPST	240°F	210°F	1.88"	2.8"	3.12"	HH12ZB240, HH12ZA240, HH12ZA252, P331-2217	B1370903				
SHL510	L150-20 SPST	150°F	130°F	1.625"	1.44"	3.12"	HH12ZB150			47-25349-03		
SHL511	L160-20 SPST	160°F	140°F	1.625"	1.44"	3.12"	HH12ZB160	1370908S		47-21711-07		
SHL512	L170-20 SPST	170°F	150°F	1.625"	1.44"	3.12"	HH12ZB170			47-25350-06		
SHL513	L170-40 SPST	170°F	130°F	1.88"	2.94"	3.12"	HH12ZB170		26H66		SWT1258	
SHL514	L180-40 SPST	180°F	140°F	1.88"	2.94"	3.12"	HH12ZB180		37H73			
SHL515	L200-40 SPST	200°F	160°F	1.88"	2.94"	3.12"	HH12ZB200, HH12ZA199, HH12ZA201		49L03	47-25349-05	SWT1260	025-29041-006
SHL516	L210-40 SPST	210°F	170°F	1.88"	2.94"	3.12"	HH12ZB210					
SHL517	L220-40 SPST	220°F	180°F	1.88"	2.94"	3.12"	HH12ZB220, HH12ZA219, HH12ZA223, 48NHT042, 620BE, 0122				SWT1273	
SHL518	L250-40 SPST	250°F	210°F	1.88"	2.94"	3.12"	HH12ZB250, HH12ZA251, P331-2208	B1370012S			SWT1261, SWT1272	
SHL519	L155-30 SPST	155°F	125°F	1.88"	2.8"	7.12"		B1370006				



Manual Reset Limit Control* - Open on Rise

SUPCO No.	Description	Cut Out	Cut In
SHM130	Limit - Open on Rise	130	Manual
SHM160	Limit - Open on Rise	160	Manual
SHM170	Limit - Open on Rise	170	Manual
SHM180	Limit - Open on Rise	180	Manual
SHM190	Limit - Open on Rise	190	Manual
SHM200	Limit - Open on Rise	200	Manual
SHM290	Limit - Open on Rise	290	Manual
SHM350	Limit - Open on Rise	350	Manual

*Adapter Flange Plate included with each thermostat.

*Use 60T Electrical Ratings





New! Rollout Switches

Features/Benefits

- Auto and Manual Reset
- Offered in a broad temperature range to cover most heating applications
- Use 36T Electrical Ratings

Applications

- Automatic or Manual Rollout safety in gas fired furnaces, unit heater and roof top units.

THERMODISC



Small Flush Mount SPST Limit Thermostats (Flush Mount Automatic Rollout)

SUPCO No.	Terminals	Cut Out	Cut In	Differential
SLF130-VA	Vertical 1/4"	130	115	15
SLF155-VA	Vertical 1/4"	155	115	40
SLF158-VB	Vertical 3/16"	158	118	40
SLF165-VA	Vertical 1/4"	165	125	40
SLF170-VA	Vertical 1/4"	170	130	40
SLF185-VB	Vertical 3/16"	185	145	40
SLF190-HA	Horizontal 1/4"	190	150	40
SLF194-HB	Horizontal 3/16"	194	154	40
SLF194-VB	Vertical 3/16"	194	154	40
SLF200-HA	Horizontal 1/4"	200	160	40
SLF200-VA	Vertical 1/4"	200	160	40
SLF210-HA	Horizontal 1/4"	210	170	40
SLF222-VA	Vertical 1/4"	222	182	40
SLF230-HA	Horizontal 1/4"	230	190	40
SLF230-HB	Horizontal 3/16"	230	190	40
SLF250-HA	Horizontal 1/4"	250	200	50
SLF252-VA	Vertical 1/4"	252	202	50
SLF252-VB	Vertical 3/16"	252	202	50
SLF255-VA	Vertical 1/4"	255	205	50
SLF260-HA	Horizontal 1/4"	260	210	50
SLF275-HB	Horizontal 3/16"	275	225	50
SLF275-VB	Vertical 3/16"	275	225	50
SLF280-HB	Horizontal 3/16"	280	230	50
SLF300-HB	Horizontal 3/16"	300	250	50
SLF300-VA	Vertical 1/4"	300	250	50
SLF330-VA	Vertical 1/4"	330	280	50

Automatic Rollouts - SPST Limit Thermostats

SUPCO No.	Terminals	Cut Out	Cut In	Differential
SLS85	45° angle 1/4" Terminals	85	70	15
SLS120	45° angle 1/4" Terminals	120	105	15
SLS130	45° angle 1/4" Terminals	130	115	15
SLS140	45° angle 1/4" Terminals	140	100	40
SLS145	45° angle 1/4" Terminals	145	105	40
SLS150	45° angle 1/4" Terminals	150	110	40
SLS155	45° angle 1/4" Terminals	155	115	40
SLS160	45° angle 1/4" Terminals	160	120	40
SLS165	45° angle 1/4" Terminals	165	125	40
SLS170	45° angle 1/4" Terminals	170	130	40
SLS175	45° angle 1/4" Terminals	175	135	40
SLS180	45° angle 1/4" Terminals	180	140	40
SLS200	45° angle 1/4" Terminals	200	160	40
SLS250	45° angle 1/4" Terminals	250	200	50
SLS255	45° angle 1/4" Terminals	255	205	50
SLS265	45° angle 1/4" Terminals	265	215	50
SLS275	45° angle 1/4" Terminals	275	225	50
SLS285	45° angle 1/4" Terminals	285	235	50
SLS295	45° angle 1/4" Terminals	295	245	50
SLS300	45° angle 1/4" Terminals	300	250	50
SLS300HB	Horizontal 3/16" Terminals	300	250	50
SLS350	45° angle 1/4" Terminals	350	300	50

Automatic Rollouts - SPST Limit Thermostats Special 30mm Center to Center

SUPCO No.	Terminals	Cut Out	Cut In	Differential
SLSW210	45° angle 1/4" Terminals	210	170	40
SLSW300	45° angle 1/4" Terminals	300	250	50
SLSW300HB	Horizontal 3/16" Terminals	300	250	50
SLSW350	45° angle 1/4" Terminals	350	300	50

Manual Rollouts - Flush Mount SPST Limit Thermostats

SUPCO No.	Terminals	Cut Out	Cut In
SRLF275VA	Vertical 1/4"	275	Manual
SRLF320VA	Vertical 1/4"	320	Manual

Manual Rollouts - SPST Limit Thermostats

SUPCO No.	Terminals	Cut Out	Cut In
SRL130	Vertical 1/4"	130	Manual
SRL135	Vertical 1/4"	135	Manual
SRL220	Vertical 1/4"	220	Manual
SRL230	Vertical 1/4"	230	Manual
SRL240	Vertical 1/4"	240	Manual
SRL250	Vertical 1/4"	250	Manual
SRL260	Vertical 1/4"	260	Manual
SRL300	Vertical 1/4"	300	Manual
SRL350	Vertical 1/4"	350	Manual



New! HVAC Flush Mount Adjustable Airstream Thermostats

SUPCO No.	5/16" Airstream Insert	Adjustable Range	Differential	Brand	OEM No.
HF757	Fan - Open on Rise	70 180	30	White Rodgers	757-1
HL758	Limit - Close on Rise	110 200	30	White Rodgers Carrier	758-1 HH680316



HVAC Flush Mount Staging Thermostat

SUPCO No.	Description	Cut Out	Cut In	Differential
FL50-15	HVAC Staging Thermostat	50	35	15
FL60-15	HVAC Staging Thermostat	60	45	15





Adjustable AT Series

- Series covers almost 95% of heater and dryer applications
- Dial knob
- 40° adjustable range
- 1/4" quick connect terminals
- Use 60T Electrical Ratings



THERMODISC



Adjustable Thermostats

SUPCO No.				
Standard Mount	Flush Mount	Adjustable Range		Differential
AT012	FLAT012	135	175	20
AT013	FLAT013	175	215	40
AT014	FLAT014	210	250	40
AT015	FLAT015	250	290	40

Adjustable Airflow Thermostats

SUPCO No.				
Standard Mount	Flush Mount	Adjustable Range		Differential
AT021	FLAT021	90	130	20
AT022	FLAT022	140	180	20



New!

Fan Control* - Close on Rise

SUPCO No.	Description	Cut In	Cut Out	Differential
SHF90	Fan	90	80	10
SHF110	Fan	110	90	20
SHF110DC	Fan - Deep Cup	110	90	20
SHF120	Fan	120	110	10
SHF130	Fan	130	115	15
SHF140	Fan	140	120	20
SHF150	Fan	150	130	20
SHF160	Fan	160	140	20
SHF170	Fan	170	150	20
SHF180	Fan	180	150	30
SHF200	Fan	200	180	20
SHF250	Fan	250	220	30

*Adapter Flange Plate included with each thermostat.

*Use 60T Electrical Ratings

Limit Control* - Open on Rise

SUPCO No.	Description	Cut Out	Cut In	Differential
SHL120	Limit - Open on Rise	120	110	10
SHL140	Limit - Open on Rise	140	100	40
SHL150	Limit - Open on Rise	150	110	40
SHL160	Limit - Open on Rise	160	120	40
SHL170	Limit - Open on Rise	170	130	40
SHL180	Limit - Open on Rise	180	140	40
SHL190	Limit - Open on Rise	190	150	40
SHL200	Limit - Open on Rise	200	160	40
SHL210	Limit - Open on Rise	210	170	40
SHL230	Limit - Open on Rise	230	190	40
SHL250	Limit - Open on Rise	250	210	40
SHL300	Limit - Open on Rise	300	250	50
SHL325	Limit - Open on Rise	325	275	50

*Adapter Flange Plate included with each thermostat.

*Use 60T Electrical Ratings

New!

Suspended Limit Thermostat (Terminal Suspended)



SUPCO No.	Description	Range			Brand	OEM No.
		Open°F	Close°F	Diff°F		
SAL105	Airflow Limit - Open on Rise	105	90	15	Janitrol	B1340104
SAL115	Airflow Limit - Open on Rise	115	100	15	Janitrol	B1340101
SAL120	Airflow Limit - Open on Rise	120	105	15	Janitrol	B1340102
SAL135	Airflow Limit - Open on Rise	135	120	15	GE	08-1912-00
						08-2399-00
						WP28X55
					Janitrol	B1340103
					TOD	312547
						313611
					Whirlpool	1160509
						1164407

*Use 60T Electrical Ratings



New!

Deep Cup Limit Thermostat

SUPCO No.	Range			Brand	OEM No.
	Open°F	Close°F	Diff°F		
L135DC	135	120	15	Electrolux	5308013213
L145DC	145	125	20	Electrolux	5308015847
L210DC	210	170	40	Armstrong	01851A-025
					18J37
					1851A
					18J3701

*Use 60T Electrical Ratings

Direct Replacement Thermistors

SUPCO No.	Description	Range	Brand	OEM No.
TH7001	Thermistor	1K @ 70 F	Maytag	307208
TH7010	Thermistor	10K @ 70 F	Maytag	306056

*Use 60T Electrical Ratings

Thermal Cut Outs

SUPCO No.				
15 Amp Series 1	25 Amp Series 2	°C	°F	Style
STC4162	STC8162	72	162	A
STC4170	STC8170	77	170	A
STC4183	STC8183	84	183	A
STC4195	STC8195	91	195	A
STC4199	STC8199	93	199	A
STC4208	STC8208	98	208	A
STC4220	STC8220	104	220	A
STC4228	STC8228	109	228	A
STC4242	STC8242	117	242	A
STC4250	STC8250	121	250	A
STC4257	STC8257	125	257	A
STC4283	STC8283	139	283	A
STC4300	STC8300	149	300	A
STC4300	STC8321	149	300	A
STC4333	STC8333	167	333	A
STC4378	STC8378	192	378	A
STC4438	STC8438	226	438	A
STC4468	STC8468	242	468	A
STC5257	STC85257	125	257	B
STC5283	STC85283	139	283	B
STC5300	STC85300	149	300	B
STC5333	STC85333	167	333	B
STC5377	STC85377	192	377	B
STC6257	STC86257	125	257	C
STC6283	STC86283	139	283	C
STC6300	STC86300	149	300	C
STC6333	STC86333	167	333	C
STC6377	STC86377	192	377	C

Series ¹Maximum Wattage 1800W @ 120V / 2400W @ 240
 Series ²Maximum Wattage 3000W @ 120V / 6000W @ 240

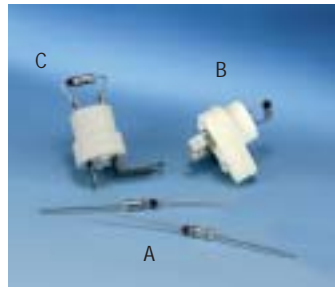

THERMODISC

Thermostats



Thermal Cut Outs

SUPCO No.	Terminals	°C	°F	Style
STF4170	QC. 1/4"	77	170	36T
STF4183	QC. 1/4"	84	183	36T
STF4208	QC. 1/4"	98	208	36T
STF4221	QC. 1/4"	105	221	36T
STF4230	QC. 1/4"	110	230	36T
STF4242	QC. 1/4"	117	242	36T
STF4249B	QC. 3/16"	121	249	36T
STF4262	QC. 1/4"	128	262	36T
STF4291B	QC. 3/16"	144	291	36T
STF4305	QC. 1/4"	152	305	36T
STF4305B	QC. 3/16"	152	305	36T

*Maximum Wattage 1800W @ 120V / 2400W @ 240

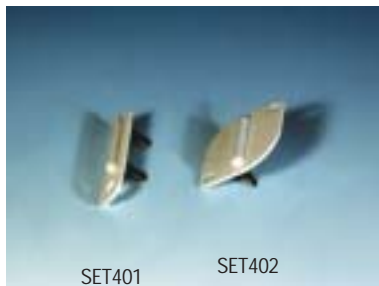

* SET405 includes one (1) high limit gas thermostat (53-1096), one (1) high limit electric thermostat (53-0771) and one (1) thermal fuse (53-1182).



Direct Replacement Specialty Thermostats and Fuses

SUPCO No.	Range			Brand	OEM No.
	Open°F	Close°F	Diff°F		
SET103	205	165	40	Whirlpool	279048
SET145	150	110	40	Maytag	30306-3
SET175	220	180	40	Maytag	303395
SET176	248	168	80	Maytag	53-0771
				Whirlpool	702548
					3390291
					696397
SET184	Hi-Temp Cut-out Kit			Whirlpool	279769
SET185	250	170	80	Whirlpool	3977767
SET186	130	115	15	GE	WE4X670
SET187	135	120	15	GE	WE4X811
					WE4X691
					WE4M127
SET188	140	125	15	GE	WE4X587
					WE4X694
SET189	155	125	25	GE	WE4X856
					WE4X583
SET190	230	190	40	GE	WE4X813

SUPCO No.	Range			Brand	OEM No.
	Open°F	Close°F	Diff°F		
SET191	250	200	50	GE	WE4X584
SET192	300	260	40	GE	WE4X592
SET193	325	275	50	GE	WE4X812
					WE4X820
SET401	196	Single Shot Fuse (3/16" Terminals)		GE	WE4X857
				Whirlpool	3392519
					3388651
SET402	196	Single Shot Fuse (1/4" Terminals)		Whirlpool	3390719
					690198
SET403	300	Small Flange Fuse		Maytag	53-1182
SET404	240	200	40	Maytag	53-1096
SET405	3 Piece Kit			Maytag	LA1053
SET406	222	Small Flange Fuse		Electrolux	5303209182
SET407	183	Single Shot Fuse		Maytag	33001762
SET408	183	Single Shot Fuse		Maytag	306604
SET409	243	Single Shot		Maytag	307473
SET410	196	Single Shot Fuse (1/4" Terminals)		Whirlpool	3399849



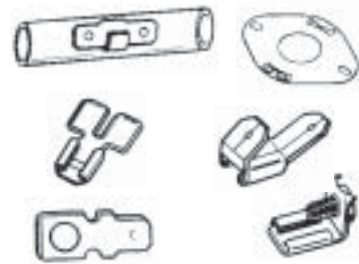

Terminal Adapters

SUPCO No.	Description	Where Used
HA-11	Large Flange / Airstream Adapter	60T to Oversize Flange
T1121	2 to 1 Terminal Adapter	1/4" O.C. Female to 2 Male 1/4" O.C. Chair Terminal
T1122	2 to 1 Terminal Adapter	1/4" O.C. Female to 2 Male 1/4" O.C. Side by Side Terminal
T1123	Screw to Terminal Adapter	8 - 10 Stud to 1/4" O.C. Terminal
T1124	Terminal to Screw Adapter	1/4" O.C. Female to Screw Right Angle Terminal
T1125	2 to 1 Terminal Adapter	1/4" O.C. Female to 1/4" O.C. Male Piggyback Terminal

New!



Flush Mount SPST Thermostats

SUPCO No.	Description	Cut Out	Cut In	Differential	Brand	Reference
FL135	Flush Mount SPST	135	120	15	Whirlpool Maytag	295419 C2735801
FL15020	Flush Mount SPST	150	110	20	Maytag	302850
FL15040	Flush Mount SPST	150	110	40	Maytag	302850
FL155	Flush Mount SPST	155	125	30	Maytag	303036 305865
FL190	Flush Mount SPST	190	180	10	Maytag	300858
FL200	Flush Mount SPST	200	160	40	Electrolux Franklin Whirlpool	5308015856 F136204 688474
FL205	Flush Mount SPST	205	165	40	Electrolux Maytag Whirlpool	5308013695 5308950121 303396 338471 341196 279048 660036
FL220	Flush Mount SPST	220	180	40	Maytag	301451 303395
FL225	Flush Mount SPST	225	185	40	Maytag	62641 510701
FL240	Flush Mount SPST	240	190	50	Maytag	305169
FL250	Flush Mount SPST	250	200	50	Electrolux GE Maytag Whirlpool	3204267 WE4X5137 348156 4451442
FL260	Flush Mount SPST	260	210	50	GE Whirlpool	WE4X5099 WE4X5176 4452223
FL285	Flush Mount SPST	285	235	50	Electrolux	5303281113
FL320	Flush Mount SPST	320	270	50	Electrolux	5307531201 7525560
FL350-50	Flush Mount SPST	350	300	50	Maytag	40113801

*Use 60T Electrical Ratings



Flush Mount SPDT Thermostats

SUPCO No.	Description	Cut Out	Cut In	Differential	Brand	Reference
FLD135	Flush Mount SPDT	135	120	15	Maytag	61372M R099113
FLD205	Flush Mount SPDT	205	165	40	Whirlpool	279048 341247 660036

*Use 60T Electrical Ratings



SPST Multi-Thermostats with heaters

SUPCO No.	Description	Cut Out	Cut In	Differential	Brand	Reference
L14520W	Multi-Temp SPST	145	125	20	Electrolux Maytag	131298300 31001192
L15515W	Multi-Temp SPST	155	140	15	Maytag	306911 306967
L15525W	Multi-Temp SPST	155	130	25	Whirlpool	3387134

*Use 60T Electrical Ratings



SPDT Multi-Thermostats with heaters

SUPCO No.	Description	Cut Out	Cut In	Differential	Brand	Reference
LD14520W	Multi-Temp SPDT	145	125	20	Whirlpool	3398128
LD15510W	Multi-Temp SPDT	155	145	10	Whirlpool	3387138
LD155W	Multi-Temp SPDT	155	130	25	Whirlpool	3387134
LD290W	Multi-Temp SPDT	290	250	40	Whirlpool	279054 342763

*Use 60T Electrical Ratings





General Purpose L & LD Series

- Open on rise
- Close when temperature differential is reached
- 1/4" quick disconnect terminals
- Use 60T Electrical Ratings

Applications

- Most home laundry dryers
- Fan and Limit Applications



UL RECOGNIZED

THERMODISC



Thermostats

"L" Series , Single Pole - Single Throw

Part No.	°Diff.	Open(°F)	Close(°F)
L120	10	120	110
L125	10	125	115
L130	15	130	115
L135	15	135	120
L140	20	140	120
L145	20	145	125
L150	20	150	130
L155	20	155	135
L160	20	160	140
L165	20	165	145
L170	20	170	150
L175	20	175	155
L180-20	20	180	160
L180-40	40	180	140

Part No.	°Diff.	Open(°F)	Close(°F)
L190	40	190	150
L200	40	200	160
L205	40	205	165
L225	40	225	185
L240	40	240	200
L250	40	250	210
L260	40	260	220
L270	40	270	230
L290	40	290	250
L300	40	300	260
L320	40	320	280
L340	40	340	300
SL2641*	40	225	185

*Flush Mount

SPDT Thermostats

SUPCO No.	Description	Cut Out	Cut In	Differential
LD120	SPDT Thermostats	120	105	15
LD130	SPDT Thermostats	130	115	15
LD135	SPDT Thermostats	135	120	15
LD140	SPDT Thermostats	140	120	20
LD145	SPDT Thermostats	145	125	20
LD155	SPDT Thermostats	155	135	20
LD170	SPDT Thermostats	170	150	20
LD190	SPDT Thermostats	190	170	20
LD200	SPDT Thermostats	200	160	40
LD210	SPDT Thermostats	210	170	40
LD225	SPDT Thermostats	225	185	40
LD240	SPDT Thermostats	240	200	40
LD270	SPDT Thermostats	270	230	40
LD290	SPDT Thermostats	290	250	40
LD305	SPDT Thermostats	305	265	40

New!



Exact Dryer Flame Sensors

- Senses igniter for heat and opens gas valve for burner
- Safety device in flame out condition

Part No.	OEM	OEM Part No.
DE353	Whirlpool	338906
DE355	GE	WE4X448



Mounting Clips

- Three to a pack

Part No.	Description
SL243	Surface Mount Style
SL245	Snap-on Style
SL247	Snap-on Style
SL249	Tube Mount Style



ML & SL Series Defrost/Icemaker Thermostats

- Metal case
- ML Series has 24" leads
- SL Series has 42" leads
- All rated 10A/120V, 5A/240V



THERMODISC

ML SERIES Part No.	SL SERIES Part No.	°Diff.	Open°F	Close°F
ML37		10	37	47
ML45	SL45	20	45	25
ML50	SL50	20	50	30
ML55	SL55	20	55	35
ML60	SL60	20	60	40
ML70	SL70	20	70	50
ML80	SL80	50	80	30
ML90	SL90	55	90	35

Typical Electrical Ratings

36T Electrical Ratings

VAC	Resistive (Non-Inductive)	Motor Rating (Inductive)		Pilot Duty
		Full Load	Locked Rotor	
120	15A	3A	12A	125 VA
240	10A	1.5A	6A	125 VA

350°F Max Ambient Temperature

60T Electrical Ratings

















VAC	Resistive (Non-Inductive)	Motor Rating (Inductive)		Pilot Duty
		Full Load	Locked Rotor	
120	25.0A	14.0A	72.0A	125 VA
240	25.0A	10.0A	60.0A	125 VA

350°F Max Ambient Temperature



SL Series, Exact Replacement Defrost/Icemaker Thermostats





THERMIDISC

SL10010	SL2205	SL2690	SL2691
Open 55°F	Open 50°F	Open 47°F	Open 55°
Close 25°F	Close 10°F	Close 22°F	Close 20°
Tube Mount 3/8" side	Tube Mount Side clip over tube	Tube Mount Clip around tube	Mount Kit (includes tube clip & push-in)
Replaces GE WR50X10010 GE WR50X131	Replaces Franklin F112205	Replaces Gibson G162690-1 Frigidaire 08000073, 08000805, 5303917625	Replaces Frigidaire 5303917954 GE WR50X55
			
SL2697	SL3084	SL50112	SL50122
Open 70°F	Open 50°F	Open 72°F	Open 60°F
Close 12°F	Close 25°F	Close 28°F	Close 28°F
Mount Side push on	Mount Clamp	Tube Mount 3/8" push-on	Tube Mount 3/8" push-on
Replaces Whirlpool 4387489 482290	Replaces Whirlpool 4387499 483084	Replaces GE WR50X112	Replaces GE WR50X122 GE WR50X128
			
SL50124	SL50129	SL50134	SL5022
Open 72°F	Open 50°F	Open 63°F	Open 26°F
Close 28°F	Close 20°F	Close 23°F	Close 16°F
Tube Mount 0.48" push-on	Tube Mount 3/8" push-on	Tube Mount 0.48" push-on	Mount Adhesive
Replaces GE WR50X124	Replaces GE WR50X129 WR50X11, WR50X117	Replaces GE WR50X134	Replaces GE WR50X22 Icemaker WR50X9, WR50X19, WR50X5033
			
SL5430	SL5708	SL5709	SL5844
Open 130°F	Open 75°F	Open 55°F	Open 48°F
Close 120°F	Close 40°F	Close 35°F	Close 18°F
Mount N/A	Mount Flush	Mount Flush	Mount Clamp in
Replaces GE WR49X430	Replaces Bohn, Larkin, Chandler, Climate Control 5708L & 4752C	Replaces Bohn, Larkin, Chandler, Climate Control 5709L & 4751C	Replaces Compact Icemaker Thermostat Amana R0161036, R0161018, Maytag 625844, 0311729, 627180, WP 265844
			



SL Series,
Exact Replacement Defrost/Icemaker Thermostats Cont'd

THERMODISC

SL6155		SL6792		SL7490		SL7500	
Open	45°F	Open	75°F	Open	48°F	Open	72°F
Close	18°F	Close	25°F	Close	18°F	Close	28°F
Tube Mount	3/8" push-on	Mount	Surface Mount	Tube Mount	5/16" push-on	Tube Mount	3/8" push-on
Replaces	Whirlpool 2196155 4387498, 2149849, 2176066, 2161331	Replaces	Frigidaire 5300460792 C460792, Westinghouse 2564D44H05	Replaces	Whirlpool 4387490 2183073, 2176941, 9791823	Replaces	Whirlpool 4387500 1121295, 1127868, 1127867, 1127805, 1115193, 1115192, 1121294, 1118825
							
SL7503		SL7985		SL8366		SL8509	
Open	44°F	Open	32°F	Open	60°F	Open	40°F
Close	18°F	Close	17°F	Close	20°F	Close	15°F
Tube Mount	5/16" push-on	Mount	Plug-in	Mount	Snap-on	Mount	Snap-on
Replaces	Whirlpool 4387503 2149643, 2172694, 2163894, 2183072, 2182380, 2149641, 2221677, 4343917	Replaces	Whirlpool 627985, Maytag 95092-1, Amana R0161060	Replaces	Frigidaire F88366	Replaces	Admiral 52085-9 52085-5, 52085-20
							
SL8510		SL8513		SL8515		SL8517	
Open	40°F	Open	45°F	Open	55°F	Open	80°F
Close	10°F	Close	25°F	Close	15°F	Close	15°F
Mount	Snap-on	Mount	Snap-on	Mount	Snap-on	Tube Mount	Side clip over tube
Replaces	Admiral 52085-10 52085-1	Replaces	Admiral 52085-13 52085-2, 52085-29	Replaces	Admiral 52085-15 52085-11	Replaces	Admiral 52085-17
							
SL8519		SL8528		Part No			
Open	80°F	Open	47°F	SLT45	45°F	22°F	
Close	31°F	Close	15°F	SLT50	50°F	10°F	
Mount	Snap-on	Mount	Snap-on	SLT55	55°F	25°F	
Replaces	Admiral 52085-19	Replaces	Admiral 52085-28 69408966	SLT60	60°F	30°F	
				SLT70		70°F	40°F
				SLT80		80°F	15°F
							





SM999 Universal Evaporator Fan Motor Kit – 120 VAC

Features/Benefits

- Prefastened Multi Fit, Break Off Mounting Bracket
- Break Off 2" Motor Shaft With Breakaways at 1/2" and 1-1/2"
- Includes All Mounting Accessories and Hardware
- Reversible Rotation
- Single Speed

See Cross Reference on page 148.

Applications

- Replaces Over 450 Different Evaporator Type Motors.
- Direct Replacement For The GEM 240 Series, Mars 90999 and Robertshaw 33-110, 33-112 & 33-114.



Part No.	Description
SM999	120 VAC, 3000 RPM, 1/200 H.P., .31 AMP impedance protected
SM998	220 VAC, 3000 RPM, 1/200 H.P., .31 AMP impedance protected

SM998 Universal Evaporator Fan Motor Kit – 220 VAC

Features/Benefits

- Includes The Same Features / Benefits, Applications and Specifications As The SM999, Except It Operates On 220 VAC 50/60 Hz.
- Direct Replacement For The Mars 90998

Tech Tip

- When replacing a motor make sure that the type, voltage, amperage, wattage, rpm, rotation, shaft size stack size and the electrical connectors are the same as the original motor.
- Check the SUPCO SM999 Cross Reference for Motor Replacement.



SM999BKT - *New!*

SM999/SM998 Kit Replacement Motor Bracket

Exact Replacement & Utility Motors

Die Cast
Hub and Case

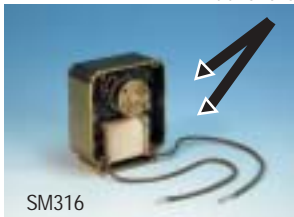

SM300 Series Exact Replacement Evaporator Motors

Features/Benefits

- OEM Exact Replacement Evaporator Fan Motors
- Manufactured to precise OEM specifications
- C Frame Design
- All models include hardware and instructions (where applicable)
- Available in 220 Volts



















Applications

- Domestic refrigerator and freezer evaporators



SUPCO Part No. SM305 GEM Part No EM305 Replaces G.E.-Hotpoint WR60X5073 WR60X84	SUPCO Part No. SM313 GEM Part No EM313 Replaces Westinghouse 5300715414	SUPCO Part No. SM316* GEM Part No EM316 Replaces FRIGIDAIRE 5303918015, 5306599388	SUPCO Part No. SM317 GEM Part No EM317 Replaces Mars 90917 GE/Hotpoint , WR60X85, WR60X100, WR60X102, WR60X162, WR60X5005
SUPCO Universal Kit Number SM245	SUPCO Universal Kit Number SM244	SUPCO Universal Kit Number SM241	SUPCO Universal Kit Number SM245
SUPCO Part No. SM319* GEM Part No EM319 Replaces FRIGIDAIRE 5303918015, 5306599389, 5306599389	SUPCO Part No. SM327* GEM Part No EM327 Replaces WHIRLPOOL - 482468	SUPCO Part No. SM328* GEM Part No EM328 Replaces WHIRLPOOL 482469, 4318002	SUPCO Part No. SM329* GEM Part No EM329 Replaces WHIRLPOOL 482731, 4318001, 2169116
SUPCO Universal Kit Number SM241	SUPCO Universal Kit Number SM241	SUPCO Universal Kit Number SM244	SUPCO Universal Kit Number SM244

*Original Howard Style

			
SUPCO Part No. SM332 GEM Part No EM332 Replaces FRIGIDAIRE 5301135442 5301135914	SUPCO Part No. SM333 GEM Part No EM333 Replaces FRIGIDAIRE 5301137820	SUPCO Part No. SM334 GEM Part No EM334 Replaces ADMIRAL 55494-7	SUPCO Part No. SM335 GEM Part No EM335 Replaces ADMIRAL 56488-2 Maytag 54482-10
SUPCO Universal Kit Number SM248	SUPCO Universal Kit Number SM247	SUPCO Universal Kit Number SM248	SUPCO Universal Kit Number SM248
			
SUPCO Part No. SM336 GEM Part No EM336 Replaces FRIGIDAIRE 5300158289	SUPCO Part No. SM337 GEM Part No EM337 Replaces AMANA C87131-1	SUPCO Part No. SM338 GEM Part No EM338 Replaces GE / Hotpoint WR60X162	SUPCO Part No. SM339 GEM Part No EM339 Replaces AMANA D72414-12
SUPCO Universal Kit Number SM245	SUPCO Universal Kit Number SM247	SUPCO Universal Kit Number SM245	SUPCO Universal Kit Number SM999
			
SUPCO Part No. SM342* GEM Part No EM342 Replaces WHIRLPOOL 1105609	SUPCO Part No. SM343 GEM Part No EM343 Replaces WHIRLPOOL 482731, 4318001, 2169116	SUPCO Part No. SM344 GEM Part No EM344 Replaces GE / Hotpoint WR60X190	SUPCO Part No. SM345 GEM Part No EM345 Replaces WHP 2183833
SUPCO Universal Kit Number SM249	SUPCO Universal Kit Number SM244	SUPCO Universal Kit Number SM999	SUPCO Universal Kit Number SM999
			
SUPCO Part No. SM346 GEM Part No EM346 Replaces WHP 2166013	SUPCO Part No. SM362 GEM Part No EM362 Replaces 69106-2	SUPCO Part No. SM365 GEM Part No EM362 Replaces C88916-5	SUPCO Part No. SM378 GEM Part No EM378 Replaces FRIG 5303917278
SUPCO Universal Kit Number SM999			SUPCO Universal Kit Number SM999
			
SUPCO Part No. SM391 GEM Part No EM391 Replaces GE WR60X191	SUPCO Part No. SM399 GEM Part No EM399 Replaces WHP 2149299		
SUPCO Universal Kit Number SM999	SUPCO Universal Kit Number SM999		

* Original "Howard Industries" Style





SM240 Series Exact Replacement Motor Kits

New!

Applications

- Domestic Refrigerator & Freezer Evaporators

Features/Benefits

- Five Motors That Replace Many Different OEM Versions
- Each Kit Contains Mounting Brackets, Hardware, Adapters & Instructions
- Heavy Duty Bearings
- Ground Steel Shaft
- Breakaway Shafts
- Impedance Protected
- 120 Volts / 60 Hz
- 3000 RPM
- Reversible Rotation
- 10" Leads
- Ground Terminal
- Replaces GEM EM240 Series Motors
- Use SUPCO SM999 To Replace GEM EM242 & EM249 Motors
- Most SM240 Motors CSA Certified



Part No.	Volts AC	RPM	Rotation (Reversible)	Shaft Diameter	Shaft Length	Replaces
SM241	120	3000	CW	Hub	3/4"	Gem EM241
SM244	120	3000	CW	Hub	1-1/8"	Gem EM244
SM245	120	3000	CW	1/8"	1-3/4"	Gem EM245
SM247	120	3000	CW	1/8"	1-7/8"	Gem EM247
SM248	120	3000	CW	3/16"	2-3/4"	Gem EM248
SM999	120	3000	CW	3/16"	2-3/4" w/breakoff	Gem EM249, Mars 90999

Exact Replacement & Utility Motors



SM600 Series Utility Motor Kits

Features/Benefits

- Versatile replacement for all "C" Frame and "3 1/2" Round Style motors
- Impedance Protected
- SM675 is thermal protected
- Available in sleeve or ballbearing design
- SM675 includes fan blade FB551 only
- Motor Kits include complete hardware and mounting kits

Applications

- Reach In Cooler & Freezer Evaporators
- Walk In Cooler & Freezer Evaporators
- Exhaust Fans
- Ventilator Fans
- Range Hoods
- Electric Unit Heaters
- Forced Air Heaters



Tech Tip

- When replacing a motor make sure that the type, voltage, amperage, wattage, rotation, shaft size, stack size and electrical connectors are the same as the original motor.

SM670 Series Specifications

SUPCO Number	Type	Volts AC	RPM	Current (Amps)	Shaft Dimensions	Stack Size	Rotation (Reversible)	Acme Miami	GEM Number	Robertshaw Number	MARS Number
SM670 ^a	Sleeve	120	3000	0.55	3/16" X 1-1/4"	5/8"	CW/CCW	600, 700, 710, 4670	EM670	14001	90971
SM671	Sleeve	120	3000	0.55	3/16" X 1-1/4"	5/8"	CW/CCW		EM671	14003	
SM672 ^a	Sleeve	240	3000	0.32	3/16" X 1-1/4"	5/8"	CW/CCW	602, 702, 4672	EM672	14005	90982
SM673 ^a	Sleeve	120	3000/1550	.55/.34	3/16" X 1-1/4"	5/8"	CW/CCW	4673	EM673	14007	
SM674	Sleeve	120	3000	0.55	3/16" X 1-1/4"	5/8"	CW/CCW		EM674	14009	
SM675 ^b	Sleeve	120/240	3000	1.0/.50	3/16" X 2-3/8"	1"	CW/CCW	7502	EM675		90970
SM676	Sleeve	120	3000	0.5	3/16" X 1-1/4"	7/8"	CW/CCW	780	EM676	14011	
SM677	Sleeve	120	2000	0.33	3/16" X 1-1/2"	5/8"	CW/CCW		EM677	14013	
SM678	Sleeve	120	3000	0.55	3/16" X 1-1/2"	1/2"	CW/CCW		EM678	14015	
SM679	Sleeve	120	3000	0.5	7/32" X 1-1/2"	5/8"	CW/CCW		EM679	14017	
SM680	Sleeve	120	3000	0.9	3/16" X 1-1/2"	1-1/8"	CW/CCW	750	EM680	14019	90970
SM681	Sleeve	120	3000/1550	.82/.21	3/16" X 1-3/8"	5/8"	CW/CCW		EM681	14021	
SM682	Sleeve	120	3000/1500	.60/.36	3/16" X 1-3/8"	1"	CW/CCW		EM682	14023	
SM683	Sleeve	240	3000	0.25	3/16" X 1-1/4"	7/8"	CW/CCW		EM683	14025	90970
SM684 ^c	Sleeve	120	3000/1550	.82/.21	7/32" X 2-1/4"	1"	CW/CCW		EM684		
SM685	Sleeve	120	3000/1550	.82/.21	3/16" X 1-3/4"	7/8"	CW		EM685		
SM686	Ball Bearing	120	3000	0.41	3/16" X 1-1/4"	5/8"	CW/CCW	BB600, BB700, BB710, BB4670	EM686		90948
SM687	Ball Bearing	120/240	3000	1.6/.80	3/16" X 2-3/8"	1-1/8"	CW/CCW	BB7502	EM687		
SM688	Ball Bearing	120	3000	0.86	3/16" X 1-1/2"	1-1/8"	CW/CCW	BB750	EM688		
SM690C	Sleeve	120	3000	0.4	3/16" X 1-1/2"	5/8"	CW		EM690C		
SM691											
SM775		120/240	3000	1.0/.52			CW/CCW		EM775		

^a Includes hardware kit: fan blades, mounting bracket, hub adapter, 1/4" shaft adapter, & 5/16" shaft adapter.

^b Includes hardware kit: fan blades, mounting bracket, hub adapter, 1/4" shaft adapter, & 5/16" shaft adapter. Motor shaft is 2-3/8" with breakoffs at 5/8" & 1-1/8".

^c Direct replacement for Gaffers & Sattler, Dynavent, Suburban, GE WB26X24, WB26X40, WB26X45



SM550 Series Ventilator Motors

Features/Benefits

- Exact Replacement for Nutone Range Hood Ventilators
- C Frame Design
- SM550 Motor includes FB460 Impeller

Applications

- Range Hoods
- Bathroom Exhaust Fans



SUPCO Part No.	Speed	RPM	Shaft Length	Rotation	Stack	Lead	NUTONE No.	ROBERTSHAW No.	GEM No.
SM550	1	3000	7/32" X 1 3/4"	CCW	1/2	120 V Plug	C65878	33-100	EM-550
SM551	2	High 3000 Low 1640	7/32" X 1 7/16"	CW	7/8	2 Speed Plug	C52367	33-101	EM-551
SM552	1	3000	7/32" X 1 1/4"	CCW	3/4	120 V Plug	C63675	33-103	EM-552
SM553	1	3000	7/32" X 1 3/4"	CCW	3/4	Eyelet	C66582	33-104	EM-553
SM554	2	High 3300 Low 3200	7/32" X 1 7/16"	CCW	7/8	2 Speed Plug	C27987	33-105	EM-554
SM555	1	3000	7/32" X 2 3/8"	CCW	5/8	120 V Plug	C68627	33-106	EM-555
SM556	1	3000	3/16" X 1 7/8"	CCW	5/8	120 V Plug	C34484	N/A	N/A



SM700 Series Ventilator Motors

Features/Benefits

- Exact Replacement for Broan Ventilators
- C Frame Design
- 120 Volts / 60 Hz
- CCW Rotation
- Multi Fit To Work With Other Brand Ventilators

Applications

- Bathroom Exhaust Fans
- Kitchen Ventilators

Tech Tips

- "F" suffix on shaft length indicates flat on shaft.
- "S" suffix indicates spline shaft.
- When replacing a motor make sure that the type, voltage, amperage, wattage, rotation, shaft size, stack size and the electrical connectors are the same as the original motor.



SUPCO Part No.	Replaces BROHN No.	Shaft Dia.	Stack	Shaft Length	Plug Type	Speed
SM700	99080218	7/32"	3/4"	1 1/4" F	3 PIN	2
SM701	99080159	1/4"	7/8"	2 3/4" F	2 PRONG	1
SM702	99080160	1/4"	7/8"	2 3/4" F	5 PIN	1
SM703	99080245	5/32"	1/2"	1 3/4" S	2 PRONG	1
SM704	99080166	7/32"	7/8"	1 1/4" F	2 PRONG	1
SM705	99080216	.181"	5/8"	1 1/2" F	2 PRONG	1



SK23 Universal Compressor Mounting Kit

Features

- Allows compressor or motor to be mounted in any position.
- Proper alignment of the liquid and suction lines, along with the electrical connections.
- Fast and easy installation
- No drilling required
- Includes template and all mounting hardware.

Applications

- Hermetic air conditioning and refrigeration compressors
- HVAC/R electric motors

Patent No. 4143843

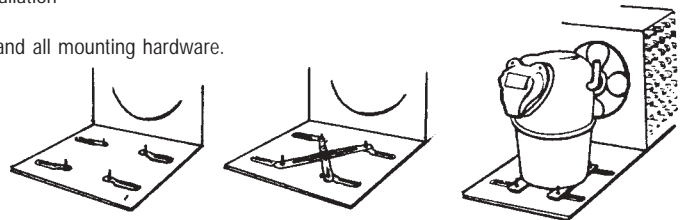

Motor Rotation as viewed facing Shaft

CW - Clockwise Rotation

CCW - Counter Clockwise

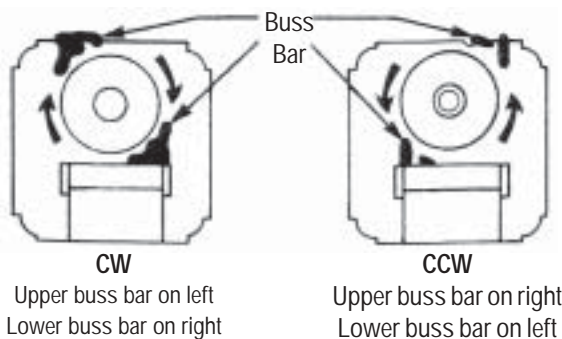

Evaporator Motor Rotation

To determine motor rotation:

CW - Clockwise CCW - Counter Clockwise

A. Facing shaft end of motor, locate the copper Buss Bar as indicated in illustration.

B. The Buss Bar location determines shaft rotation.



Acme/Miami	
400	
500	
600	
700	
800	
Admiral	
23464	
24401	
26999	
27779	
27842	
28512	
28513	
29708-1	
52121-1	
53000-1	
53001-1	
53003-3	
54482-5	
54482-9	
55394-1	
55394-7	
56488-1	
56488-2	
Amana	
A448-1	
B4850-1	
B4850-2	
B5546-1	
B5546-4	
B5614-1	
B5640-1	
C35256-1	
C35256-7	
C35363-1	
C35363-7	
C35656-1	
C35656-5	
C35657-1	
C35759-1	
C35759-5	
C35759-6	
C35759-9	
C35759-10	
C36806-1	
C36806-2	
C36811-1	
C36840-1	
C36893-1	
C36893-2	
C87131-1	
D71157-1	
D71157-2	
D71157-3	
D71157-4	
D72414-1	
D72414-3	
D72414-4	
D72414-5	
D72414-6	
D72414-7	
D72414-8	
D72562-1	
D72562-3	
D74649-3	
M3020-1	
M3020-2	
M3035-1	

M3035-2	
M3035-4	
M3076-1	
M3076-2	
R1570-68	
R1570-87	
Franklin	
58835	
82169	
82388	
84493	
88130	
88162	
94606	
96740	
116267	
Frigidaire	
62035	
620929	
620962	
621086	
621891	
622462	
622852	
622892	
622937	
523048	
623319	
623686	
625094	
625647	
627283	
627286	
627289	
627293	
627414	
627879	
628524	
629965	
629966	
1135442	
1135914	
1137820	
5903130	
6540267	
6540268	
6582708	
6583827	
6584668	
6598467	
6598468	
6598499	
6598501	
6598503	
6598504	
6598507	
6599014	
6599015	
6599016	
6599017	
6599388	
6599389	
6599390	
6599391	
7512280	
7514087	
7515415	
7515434	
7515803	

7516385	
7516386	
7516457	
7517873	
7543975	
7544495	
7546181	
7546735	
9956921	
9956922	
9956924	
GE/Penncrest	
WR49X5039	
WR49X5040	
WR49X5082	
WR49X5091	
WR60X50	
WR60X52	
WR60X54	
WR60X57	
WR60X60	
WR60X65	
WR60X66	
WR60X69	
WR60X71	
WR60X74	
WR60X82	
WR60X84	
WR60X85	
WR60X88	
WR60X96	
WR60X100	
WR60X104	
WR60X105	
WR60X5005	
WR60X5012	
WR60X5016	
WR60X5020	
WR60X5021	
WR60X5022	
WR60X5023	
WR60X5024	
WR60X5035	
WR60X5046	
WR60X5047	
WR60X5049	
82388	
88162	
106348	
106349	
115560	
132968	
133602	
136611	
137417	
138153	
138327	
139295	
Gem	
EM241	
EM242	
EM244	
EM245	
EM247	
EM248	
EM249	
EM301	
EM302	
EM303	

EM304	
EM305	
EM306	
EM307	
EM308	
EM309	
EM310	
EM311	
EM312	
EM313	
EM314	
EM315	
EM316	
EM317	
EM318	
EM319	
EM320	
EM321	
EM322	
EM323	
EM324	
EM325	
EM326	
EM327	
EM328	
EM329	
EM330	
EM331	
EM332	
EM333	
EM334	
EM335	
EM336	
EM671	
Gibson	
F88162	
F116267	
K1230532	
101493	
101730	
104076	
109216	
110968	
123449	
126119	
127816	
134639	
137417	
139044	
139046	
143259	
146620	
152646	
163865	
Kelvinator	
F88162	
1159624	
1159782	
1159808	
1166476	
1166681	
1166971	
1167246	
1202158	
1202159	
1204665	
1204667	
1205028	
1206352	

1206353	
1206354	
1206452	
1206453	
1208099	
1209560	
1220352	
1222931	
1222932	
1226505	
1227015	
1227017	
1228883	
1230532	
Mars	
90999	
Montgomery Ward	
C38785	
C38791	
C48400	
C48401	
C48507	
C48508	
C48580	
C282296	
C289296	
C460752	
27779	
28512	
521211	
530011	
537061	
537651	
537671	
544821	
544823	
553941	
557351	
564881	
564882	
58835	
82388	
88162	
116267	
621891	
623319	
625094	
625647	
627414	
627879	
628523	
628524	
629965	
1135914	
137820	
6599014	
6599388	
6599389	
6599390	
7515434	
Norge	
124795	
126392	
131848	
132414	
134227	
544825	
544829	

564881	
564882	
Philco	
51030391	
51030451	
5104012	
5104025	
51040501	
51040503	
51040504	
510405006	
510405007	
510405010	
510405011	
510405013	
510405015	
510405016	
510405017	
510405021	
51040541	
51040542	
51040561	
51040562	
51040591	
51040631	
5833030	
5835008	
5835009	
5838017	
Robertshaw	
33-110	
33-112	
33-114	
Westinghouse	
C28542	
C28543	
C28545	
C28546	
C28748	
C28751	
C38088	
C38089	
C38090	
C38785	
C38788	
C38791	
C48400	
C48401	
C48507	
C48508	
C48579	
C48580	
C48581	
C57230	
C62773	
C289296	
C289298	
C289448	
C460277	
C460411	
C460752	
C460878	
C712838	
C715414	
Whirlpool	
40600	
41862	

42275	
43206	
44057	
466766	
467248	
468703	
468705	
472782	
474481	
480657	
481384	
482467	
482468	
482469	
482470	
482495	
485144	
5401672	
513580	
513923	
515235	
515240	
517441	
517472	
518707	
518782	
519218	
520024	
526184	
530314	
530452	
530675	
530763	
531645	
531646	
531647	
531648	
531826	
531885	
531916	
547388	
547954	
547956	
548042	
548144	
548262	
548697	
549098	
549212	
549420	
552911	
604089	
604667	
79990	
833502	
833528	
833752	
833768	
850144	
851170	
851845	
867004	
876351	
978212	
987369	



Motors Cross Reference

OEMNumber	SUPCO Direct	SUPCO Kit
Electrolux / Frigidaire / Gibson / Franklin / Kelvinator / Tappan / Westinghouse		
00620365	SM316*	SM241
00620962	SM316*	SM241
00621891	SM316*	SM241
00622462	SM316*	SM241
00622852	SM316*	SM241
00623048	SM316*	SM241
00623319	SM316*	SM241
00623319	SM319*	SM241
00625094	SM316*	SM241
00627283		SM244
00627286	SM316*	SM241
00627289	SM316*	SM241
00627293	SM316*	SM241
00627293	SM319*	SM241
00627414	SM333	SM247
00627879	SM332	SM248
00628524		SM244
00628530	SM316*	SM241
00628531	SM316*	SM241
00629965		SM244
00629966	SM316*	SM241
00629968	SM316*	SM241
01135442	SM332	SM248
01135914	SM332	SM248
01137820	SM333	SM247
02149299	SM399	SM999
02162404	SM399	SM999
02188303	SM399	SM999
03001224	SM336	SM245
03001421	SM336	SM245
04389144	SM399	SM999
05899695		SM244
06540268		SM244
06583660		SM244
06598499		SM244
06598504		SM241
06598507	SM316*	SM241
06599014	SM316*	SM241
06599015	SM316*	SM241
06599015	SM319*	SM241
06599388	SM316*	SM241
06599389	SM316*	SM241
06599389	SM319*	SM241
07512280		SM244
07514087		SM244
07515434	SM316*	SM241
07515434	SM319*	SM241
07515803		SM241
07516457	SM316*	SM241
07516457	SM319*	SM241
07517873		SM244
07544495	SM316*	SM241
07544495	SM319*	SM241
07546181	SM316*	SM241
07546735	SM316*	SM241
08000036	SM336	SM245
08004176	SM336	SM245
09956924		SM241
215213300	SM378	SM999
215314700	SM336	SM245
215348100	SM378	SM999
215348200	SM336	SM245
215360800	SM336	SM245
215464000	SM336	SM245
215464100	SM336	SM245
218322200	SM336	SM245
218394100	SM378	SM999
218661700	SM336	SM245
218718402	SM378	SM999
218718403	SM336	SM245
218878700	SM336	SM245
218878701	SM336	SM245
218878901	SM336	SM245
5300137417		SM247
5300715414	SM313	SM244

OEMNumber	SUPCO Direct	SUPCO Kit
5301135442	SM332	SM248
5301135914	SM332	SM248
5301137820	SM333	SM247
5301230532		SM245
5303275816	SM336	SM245
5303310100	SM336	SM245
5303917277	SM336	SM245
5303917278	SM378	SM999
5303917473	SM336	SM245
5303917707		SM244
5303918015	SM316*	SM241
5306598499		SM244
5306599388	SM316*	SM241
5306599389	SM319*	SM241
5306599389	SM316*	SM241
2660D62H03	SM313	SM244
C00028542	SM313	SM244
C000028543	SM313	SM244
C000028545	SM313	SM244
C000028546	SM313	SM244
C000028748	SM313	SM244
C000028751	SM313	SM244
C000038088	SM313	SM244
C000038089	SM313	SM244
C000038090	SM313	SM244
C000038785	SM313	SM244
C000038788	SM313	SM244
C000038791	SM313	SM244
C000048400	SM313	SM244
C000048401	SM313	SM244
C000048579	SM313	SM244
C000048580	SM313	SM244
C000048581	SM313	SM244
C000057230	SM313	SM244
C000289296	SM313	SM244
C000289298	SM313	SM244
C000289448	SM313	SM244
C000460752	SM313	SM244
C000715414	SM313	SM244
EB087812		SM244
F82388		SM244
F88162		SM244
G000137417		SM247
G000158289	SM336	SM245
G000168579	SM336	SM245
G000173301	SM336	SM245
G101730		SM247
G104371		SM247
G104372		SM247
G109216		SM247
G123449		SM247
G137417		SM247
G139044		SM247
G139046		SM247
G143259		SM245
G154984		SM245
G158289	SM336	SM245
G162705	SM336	SM245
G163939	SM336	SM245
G165335	SM336	SM245
G168579	SM336	SM245
G168797	SM336	SM245
G173301	SM336	SM245
G176117	SM336	SM245
G178481	SM336	SM245
G99117		SM247
G99181		SM247
K001230532		SM245
K1166971		SM245
K1167140		SM245
K1167289		SM245
K1204667	SM336	SM245
K1227008		SM245
K1227015		SM245
K1227017		SM245
K1228883		SM245
K1229280		SM245

OEMNumber	SUPCO Direct	SUPCO Kit
K1229293		SM245
K1230532		SM245
General Electric / Hotpoint / Penncrest		
SWR60X172	SM344	SM999
WR49X5039		SM248
WR49X5040		SM248
WR49X5082	SM305	SM245
WR49X5082		SM245
WR60X100	SM338 / SM317	SM245
WR60X104	SM338 / SM317	SM245
WR60X105	SM338 / SM317	SM245
WR60X108	SM338 / SM317	SM245
WR60X112	SM338 / SM317	SM245
WR60X116	SM338 / SM317	SM245
WR60X118	SM338 / SM317	SM245
WR60X119	SM338 / SM317	SM245
WR60X120	SM338 / SM317	SM245
WR60X122	SM338 / SM317	SM245
WR60X125	SM338 / SM317	SM245
WR60X126	SM338 / SM317	SM245
WR60X127	SM338 / SM317	SM245
WR60X129	SM338 / SM317	SM245
WR60X130	SM338 / SM317	SM245
WR60X131	SM338 / SM317	SM245
WR60X132	SM338 / SM317	SM245
WR60X160	SM338 / SM317	SM245
WR60X162	SM338 / SM317	SM245
WR60X162DS	SM338 / SM317	SM245
WR60X163	SM338 / SM317	SM245
WR60X168	SM338 / SM317	SM245
WR60X171	SM338 / SM317	SM245
WR60X172	SM344	SM999
WR60X181	SM391	SM999
WR60X182	SM344	SM999
WR60X189	SM344	SM999
WR60X190	SM344	SM999
WR60X191	SM391	SM999
WR60X197	SM391	SM999
WR60X5005	SM338 / SM317	SM245
WR60X5011	SM305	SM245
WR60X5011		SM245
WR60X5012		SM248
WR60X5016	SM305	SM245
WR60X5019		SM248
WR60X5020	SM305	SM245
WR60X5020		SM245
WR60X5021	SM305	SM245
WR60X5021		SM245
WR60X5035	SM305	SM245
WR60X5035		SM245
WR60X5040	SM305	SM245
WR60X5040		SM245
WR60X5047	SM305	SM245
WR60X5047		SM245
WR60X5048	SM305	SM245
WR60X5048		SM245
WR60X5049	SM305	SM245
WR60X5049		SM245
WR60X5052		SM248
WR60X5053	SM338 / SM317	SM245
WR60X5054	SM305	SM245
WR60X5054		SM245
WR60X5057	SM305	SM245
WR60X5057		SM245
WR60X5064	SM305	SM245
WR60X5064		SM245
WR60X5066	SM305	SM245
WR60X5066		SM245
WR60X5068		SM248
WR60X5073	SM305	SM245
WR60X5073		SM245
WR60X5074	SM305	SM245
WR60X5074		SM245
WR60X52	SM305	SM245
WR60X52		SM245



Motors Cross Reference

Motors

OEM Number	SUPCO Direct	SUPCO Kit
WR60X54	SM305	SM245
WR60X54		SM245
WR60X60	SM305	SM245
WR60X60		SM245
WR60X65	SM305	SM245
WR60X65		SM245
WR60X71	SM305	SM245
WR60X71		SM245
WR60X74	SM305	SM245
WR60X74		SM245
WR60X82	SM338 / SM317	SM245
WR60X84	SM305	SM245
WR60X84		SM245
WR60X85	SM338 / SM317	SM245
WR60X88	SM305	SM245
WR60X88		SM245
WR60X90		SM248
Maytag / Admiral / Amana / Crosley / Norge		
29708		SM248
53003	SM334	SM248
55546	SM339	SM999
045563-01		SM248
29708-1		SM248
52121-1	SM334	SM248
53003-1	SM334	SM248
53706-1		SM248
53706-2		SM248
53765-1	SM334	SM248
53767-1	SM334	SM248
54482-1		SM248
54482-10		SM248
54482-11	SM334	SM248
54482-2		SM248
54482-3		SM248
54482-4		SM248
54482-5		SM248
54482-7	SM334	SM248
54482-8		SM248
54482-9		SM248
55394-1	SM334	SM248
55394-3	SM334	SM248
55394-5	SM334	SM248
55394-7	SM334	SM248
55735-1	SM335	SM248
55735-8	SM335	SM248
56488-1	SM335	SM248
56488-2	SM335	SM248
56488-3	SM335	SM248
56488-4	SM335	SM248
56488-5	SM335	SM248
C3536301		SM245
C3536307		SM245
C3565601		SM245
C3565605		SM245
C3575901		SM245
C3575905		SM245
C3575906		SM245
C3575909		SM245
C3680601	SM337	SM247
C3681101		SM245
C3684001	SM337	SM247
C3689301		SM245
C3689302		SM245
C3690101		SM245
C3690102		SM245
C3690103		SM245
C8713101	SM337	SM247
D7115701		SM245
D7115703		SM245
D7241409	SM339	SM999
D7241412	SM339	SM999

OEM Number	SUPCO Direct	SUPCO Kit
D7256201		SM245
D7256202		SM245
D7256203		SM245
D7289701		SM245
M0307601	SM337	SM247
R0151002		SM245
RA43990-1		SM248
Whirlpool / Kitchenaid / Chambers / Roper / Coldspot		
480639	SM327	SM241
480657		SM241
481384		SM241
482415	SM328	SM244
482415	SM329	SM244
482469	SM328	SM244
482470	SM343	SM999
482495		SM241
482729	SM328	SM244
482729	SM329	SM244
482731	SM343	SM999
482733	SM343	SM999
483051	SM328	SM244
483051	SM329	SM244
513580		SM241
515235	SM327	SM241
517441	SM327	SM241
517472	SM327	SM241
517474		SM241
518041		SM241
518782		SM241
519218	SM327	SM241
520024	SM327	SM241
530314	SM327	SM241
530380		SM241
530452	SM327	SM241
530675	SM327	SM241
530763	SM327	SM241
531645	SM327	SM241
531646	SM327	SM241
531647	SM327	SM241
531648	SM327	SM241
531826	SM327	SM241
531885	SM327	SM241
531916		SM241
542954		SM241
547388		SM241
547409		SM241
547954		SM241
547956	SM327	SM241
547958	SM327	SM241
548042	SM327	SM241
548262	SM328	SM244
548262	SM329	SM244
548697	SM343	SM999
549098	SM328	SM244
549098	SM329	SM244
549212	SM328	SM244
549212	SM329	SM244
549420	SM343	SM999
631648	SM327	SM241
755182	SM327	SM241
756048	SM327	SM241
833502		SM241
833528		SM241
833752	SM327	SM241
833768	SM328	SM244
833768	SM329	SM244
850144	SM328	SM244
850144	SM329	SM244
851170	SM343	SM999
936162	SM343	SM999

OEM Number	SUPCO Direct	SUPCO Kit
936163	SM328	SM244
936163	SM329	SM244
936164	SM328	SM244
936164	SM329	SM244
937276	SM328	SM244
937276	SM329	SM244
938117	SM343	SM999
938124	SM328	SM244
938124	SM329	SM244
938149	SM343	SM999
938223	SM328	SM244
938223	SM329	SM244
938283	SM328	SM244
938283	SM329	SM244
938287	SM343	SM999
938292	SM343	SM999
938296	SM343	SM999
938372	SM328	SM244
938372	SM329	SM244
941506	SM328	SM244
941506	SM329	SM244
941547	SM343	SM999
941578	SM328	SM244
941578	SM329	SM244
941601	SM328	SM244
941601	SM329	SM244
941687	SM328	SM244
941687	SM329	SM244
945523	SM328	SM244
945523	SM329	SM244
946653	SM343	SM999
978212	SM328	SM244
978212	SM329	SM244
987369	SM328	SM244
987369	SM329	SM244
989608	SM328	SM244
989608	SM329	SM244
989687	SM343	SM999
992919	SM328	SM244
992919	SM329	SM244
1100473	SM343	SM999
1100474	SM343	SM999
1100945	SM328	SM244
1100945	SM329	SM244
1100992	SM343	SM999
1105608	SM343	SM999
1105609	SM343	SM999
1107711	SM328	SM244
1107711	SM329	SM244
1107715	SM328	SM244
1107715	SM329	SM244
1108111	SM328	SM244
1108111	SM329	SM244
1118715	SM328	SM244
1118715	SM329	SM244
2154419	SM343	SM999
2154977	SM343	SM999
2163766	SM345	SM999
2166013	SM346	SM999
2169116	SM343	SM999
2169143	SM343	SM999
2169485	SM346	SM999
2176298	SM345	SM999
2183448	SM345	SM999
2183833	SM345	SM999
4318001	SM343	SM999
4318002	SM328	SM244
4318002	SM329	SM244
8537621	SM343	SM999
9791620	SM346	SM999





Exact Replacement Plastic Impellers

Features/Benefits

- Broan & Nutone Exact Replacement Impellers
- 3 Sizes Available

Applications

- Bathroom Ventilators
- Kitchen Ventilators

Tech Tip

- "F" Suffix on impeller hole indicates impeller will accommodate flat shaft.



SUPCO Part No.	Replaces Mfg. No.	Blade O.D.	Hole I.D.
SB001	Nutone 68920	4 5/8"	.181F
FB460	Broan 9910379H	4 9/16"	.218
FB461	Broan 99110630	4 5/8"	.150



Plastic Blower Wheels

Features/Benefits

- 5 Sizes Available

Applications

- Bathroom Ventilators
- Kitchen Ventilators

SUPCO No.	Shaft	Rotation	Bottom Diameter	Depth	Top Diameter	OEM Part No.
DE343	1/2"			3 1/16"	8"	Maytag 33001043 Norge 53-0106
DE602	1/2"			3"	7 3/4"	Maytag 303836 Norge 53-0106
FB250	1/8"	CW	2 1/2"	1"	2 11/16"	
FB325	3/16"	CW	3"	1"	3 1/4"	
FB590	1/4"	CW	5 3/4"	2"	6 1/8"	Nutone 59000A



Plastic Vent Hood Fan Blades

Features/Benefits

- 2 Sizes Available

Applications

- Ducted & Non Ducted Vent Hoods

Part No.	Shaft	Diameter	No. Blades	Rotation	Pitch
FB660	7/32"	6 5/8"	5	CW	25°
FB665	7/32"	6 5/8"	5	CW	12°



Aluminum Fan Blades - General Purpose

Features/Benefits

- 22 Gauge Aluminum Alloy Construction
- Light Weight Design Reduces Bearing Wear & Vibration
- 4" to 6 1/2" Diameter Sizes Available (1/2" increments)
- Slotted Set Screw Hub Sizes 3/16", 7/32" & 1/4"
- Clockwise or Counter Clockwise Rotations

Applications

- Refrigerator & Freezer Evaporators
- Ventilators

Tech Tip

- Rotation is determined by facing air discharge

Part No.	Shaft	Diameter	No. Blades	Rotation
FB150	3/16"	4"	10	CW
FB151	1/4"	4"	10	CW
FB152	3/16"	4"	10	CCW
FB153	1/4"	4"	10	CCW
FB156	3/16"	4 1/2"	10	CW
FB157	1/4"	4 1/2"	10	CW
FB158	3/16"	4 1/2"	10	CCW
FB159	1/4"	4 1/2"	10	CCW
FB162	3/16"	5"	4	CW
FB163	7/32"	5"	4	CW
FB164	1/4"	5"	4	CW
FB165	3/16"	5"	4	CCW
FB166	7/32"	5"	4	CCW
FB167	1/4"	5"	4	CCW
FB170	3/16"	5 1/2"	4	CW
FB171	7/32"	5 1/2"	4	CW

Part No.	Shaft	Diameter	No. Blades	Rotation
FB172	1/4"	5 1/2"	4	CW
FB173	3/16"	5 1/2"	4	CCW
FB174	7/32"	5 1/2"	4	CCW
FB175	1/4"	5 1/2"	4	CCW
FB178	3/16"	6"	4	CW
FB179	7/32"	6"	4	CW
FB180	1/4"	6"	4	CW
FB181	3/16"	6"	4	CCW
FB182	7/32"	6"	4	CCW
FB183	1/4"	6"	4	CCW
FB186	3/16"	6 1/2"	4	CW
FB187	7/32"	6 1/2"	4	CW
FB188	1/4"	6 1/2"	4	CW
FB189	3/16"	6 1/2"	4	CCW
FB190	7/32"	6 1/2"	4	CCW
FB191	1/4"	6 1/2"	4	CCW

Fan Blades





Plastic Fan Blades – General Purpose

Features/Benefits

- Celcon Plastic Construction
- Light Weight Design Reduces Bearing Wear & Vibrations
- 2-1/2" to 8" Diameter Sizes Available (1/2" increments)
- Integral Hub Available In 1/8", 3/16", 1/4" & 5/16" Sizes
- Color Coded Rotation White = CW Gray = CCW
- Eliminates Bent or Misaligned Blades
- Low Air Noise
- UL Recognized
- CSA Certified

Applications

- Refrigerator & Freezer Evaporators
- Ventilators

Part No.	Shaft	Diameter	No. of Blades	Rotation
FB299	3/16"	2 1/2"	4	CW
FB300	1/8"	3"	4	CW
FB301	3/16"	3"	4	CW
FB302	3/16"	3 1/2"	4	CCW
FB350	3/16"	3 1/2"	4	CW
FB401	1/8"	4"	5	CW
FB402	3/16"	4"	5	CW
FB403	1/8"	4"	5	CCW
FB404	3/16"	4"	5	CCW
FB406	1/8"	4"	4	CW
FB501	3/16"	5"	5	CW

Part No.	Shaft	Diameter	No. of Blades	Rotation
FB502	1/4"	5"	5	CW
FB503	5/16"	5"	5	CW
FB504	3/16"	5"	5	CCW
FB505	1/4"	5"	5	CCW
FB506	5/16"	5"	5	CCW
FB550	3/16"	5 1/2"	4	CCW
FB551	1/4"	5 1/2"	4	CCW
FB601	3/16"	6"	6	CW
FB602	1/4"	6"	4	CW
FB603	5/16"	6"	4	CW
FB604	3/16"	6"	4	CCW
FB605	1/4"	6"	4	CCW

Part No.	Shaft	Diameter	No. of Blades	Rotation
FB606	5/16"	6"	4	CCW
FB650	3/16"	6 1/2"	5	CW
FB651	1/4"	6 1/2"	5	CW
FB652	5/16"	6 1/2"	5	CW
FB701	1/4"	7"	5	CW
FB702	5/16"	7"	5	CW
FB703	1/4"	7"	5	CCW
FB704	5/16"	7"	5	CCW
FB801	1/4"	8"	5	CW
FB802	5/16"	8"	5	CW
FB803	1/4"	8"	5	CCW
FB804	5/16"	8"	5	CCW

Fan Blades

Plastic Direct Replacement and Hub Type



Features/Benefits

- Eight Popular Direct Replacements
- Available in Hub or Shaft Mount 1/8", 3/16"
- Clockwise & Counter Clockwise Rotations

Applications

- Refrigerator & Freezer Evaporators

Part No.	Shaft	Diameter	Blades	Rotation	Replacement for
FB351	HUB	4"	5	CW	Universal Appl
FB352	HUB	4"	5	CCW	Universal Appl
FB353	HUB	4"	4	CCW	Whpl/Cldspt 513543
FB450	1/8"	4 1/2"	5	CCW	GE WR60X114
FB455	3/16"	5 9/16"	5	CCW	Bohn 5101B
B456	1/8"	5 9/16"	5	CCW	Bohn 5036F,5007S,5018S
FB457	1/8"	4"	4	CCW	Whirlpool/482731
FB718	HUB	7"	5	CW	Admiral 62934-2, 69958-1
FB718G	HUB	7"	5	CW	GEM FB718

Aluminum Condenser Fan Blades



Features/Benefits

- Aluminum Construction
- 9 Popular Sizes Available
- 6" to 10" Diameter
- Clockwise & Counter Clockwise Rotations
- 5 Blades

Applications













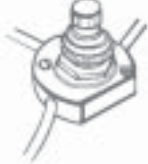



- Unit Bearing Motors with 1/4" x 20 Threaded Shafts

Tech Tip

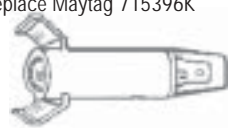
- To determine the blade rotation.
CW – Clockwise & CCW – Counter Clockwise
1. Lay blade on a flat surface (either side up).
 2. The direction of rotation is determined by observing which blade edge touches the flat surface.
 3. Left side is touching the flat surface = CW.
 4. Right side is touching the flat surface = CCW.

Part No.	Diameter	No. of Blades	Rotation	Pitch
FB101	6"	5	CW	-
FB102	6"	5	CCW	-
FB103	7"	5	CCW	20°
FB104	7"	5	CW	20°
FB105	8"	5	CCW	20°
FB106	8"	5	CW	20°
FB107	8 3/4"	5	CW	20°
FB108	10"	5	CCW	29°
FB109	10"	5	CW	22°

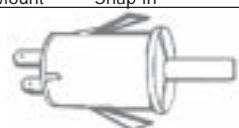
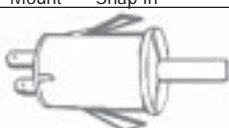
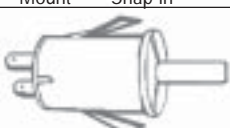
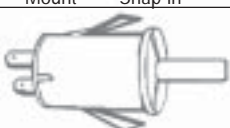











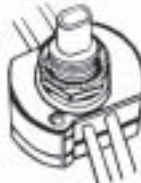









ES15100 Canopy Switch Metal Push Button On - Off Longer Threaded Shaft	ES15102 Canopy Switch Phenolic Push Button Off - On - On	ES15105 Two Speed Fan Metal Rotary Button On - Off - On	ES15106 Canopy Switch Metal Push Button On - Off Shorter Threaded Shaft	ES15108 Single Speed Rotary Metal Rotary Button On - Off
Replaces: 15100, 151	Replaces: 15102, 151-2	Replaces: 15105, 151-5	Replaces: 15106, 151-6	Replaces: 15108, 151-8
Amps 3 / 1 amps	Amps 3 / 1 amps	Amps 3 / 1 amps	Amps 3 / 1 amps	Amps 3 / 1 amps
Volts 125 / 250	Volts 125 / 250	Volts 125 / 250	Volts 125 / 250	Volts 125 / 250
Mount Threaded	Mount Threaded	Mount Threaded	Mount Threaded	Mount Threaded
				
ES15200 Pilot Light Raised Red Lens	ES15201 Pilot Light Flush Red Lens	ES15202 Pilot Light Flush Red Lens	ES15204 Pilot Light 5/16" Dia. Flush Red Lens	ES15205 Pilot Light Special for GE
Replaces: 15200, 152, 7006	Replaces: 15201, 152-1, 4157976, 4157870	Replaces: 15202, 152-2, 0088640, 0088777	Replaces: 15204, 152-4, 04000016, 7407P062-60	Replaces: 15205, 152-5, WB2X1608
Watts 1/3	Watts 1/3	Watts 1/3	Watts 1/3	Watts 1/3
Volts 125	Volts 125	Volts 250	Volts 125	Volts 125
Mount Snap in	Mount Snap in	Mount Snap in	Mount Snap in	Mount Snap in
				
ES15206 Pilot Light Clip in Pilot Light	ES15208 Plastic Lens Kit 2 replacement plastic lens for pilot lights	ES15211 Pilot Light Flush Red Lens	ES15400 Oven Door Switch 3/4" High Temperature momentary On Normally Open	ES15401 Oven Door Switch 3/4" High Temperature momentary On Normally Open
Replaces: 15206, 152-6, WB25M3, 288814, 4352421	Replaces: 15208, 152-8, 4328321, WB25M2, 530811461	Replaces: 15211, 152-11	Replaces: 15400, 154, WB24K2, WB24X795, 347305	Replaces: 15401, 154-1, 310345, 3196261
Watts 1/3	Use with ES15205 to replace Maytag 715396K	Watts 1/3	Amps 3 / 1 amps	Amps 10 / 7.5 amps
Volts 125		Volts 125	Volts 125 / 250	Volts 125 / 250
Mount Snap in		Mount Push-in	Mount Snap in	Mount Snap in
Use with ES15205 to replace Maytag 715396K				
				
ES15402 Oven Door Switch 3/4" High Temperature momentary On Normally Open	ES15403 Oven Door Switch 3/4" High Temperature momentary On Normally Open	ES15404 Oven Door Switch 3/4" High Temperature momentary On Normally Open	ES15405 Oven Door Switch 3/4" High Temperature momentary On Normally Open	ES15501 Pilot Light Rectangular Red Lens
Replaces: 15402, 154-2, 3196262	Replaces: 15403, 154-3, 4450819	Replaces: 15404, 154-4, 9781581	Replaces: 15405, 154-5, 9750896	Replaces: 15501, 155-1
Amps 10 / 7.5 amps	Amps 10 / 7.5 amps	Amps 10 / 7.5 amps	Amps 15 / 12.5 amps	Watts 1/3
Volts 125 / 250	Volts 125 / 250	Volts 125 / 250	Volts 125 / 250	Volts 125
Mount Snap in	Mount Snap in	Mount Snap in	Mount Snap in	Mount Snap in
				















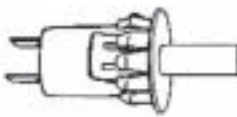

Part numbers and illustrations are intended solely for identification. Items offered for sale are not represented to be manufactured by the company that built the original equipment manufacturer, actual product may vary from illustration.

Switches



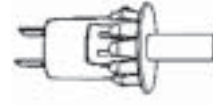
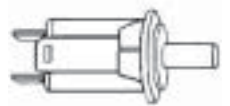

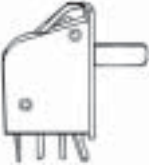

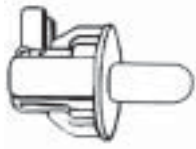







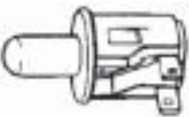
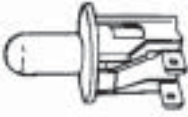

ES15502 Pilot Light Rectangular Red Lens Replaces: 15502, 155-2 Watts 1/3 Volts 250 Mount Snap in	ES15601 Pilot Light Rectangular Amber Lens Replaces: 15601, 156-1 Watts 1/3 Volts 125 Mount Snap in	ES15801 Flourescent Light Switch Metal Push Button Replaces: 15801, 158-1 Watts 40 Volts 125 Mount Pal-nut	ES15803 Toggle Switch Panel style toggle On- Off Replaces: 15803, 158-3 Amps 3 amps Volts 125 / 250 Mount Pal-nut	ES15805 Appliance Switch White Rectangular Replaces: 15805, 158-1 Amps 20 / 10 amps Volts 125 / 250 Mount Snap in
				
ES15806 Toggle Switch Panel style toggle On- Off heavy duty Replaces: 15806, 158-6 Amps 20 / 10 amps Volts 125 / 250 Mount Pal-nut	ES15807 Toggle Switch Panel style toggle On - On 3 terminal Replaces: 15807, 158-7 Amps 20 / 10 amps Volts 125 / 250 Mount Pal-nut	ES15810 Toggle Switch Panel style toggle On -Off - On 3 terminal Replaces: 15810, 158-10 Amps 15 amps Volts 125 / 250 Mount Pal-nut	ES15811 Toggle Switch SPDT Heavy Duty Switch, typically used on GE Dishwashers, and others. Replaces: 15811, 158-11 Amps 15 amps Volts 125 / 250 Mount Pal-nut	ES15813 Toggle Switch Panel style toggle On - Off - On 6 terminal Replaces: 15813, 158-13 Amps 15 amps Volts 125 / 250 Mount Pal-nut
				
ES15901 Panel Rocker Switch Panel style Rectangular Black, Fan / On - Off Replaces: 15901, 159-1 Amps 7.5 / 10 amps Volts 125 / 250 Mount Snap in	ES15902 Panel Rocker Switch Panel style Rectangular Black, Light / On - Off Replaces: 15902, 159-2 Amps 7.5 / 10 amps Volts 125 / 250 Mount Snap in	ES15903 Panel Rocker Switch Panel style Rectangular Black, On - Off Replaces: 15903, 159-3 Amps 7.5 / 10 amps Volts 125 / 250 Mount Snap in	ES15905 Panel Rocker Switch Rectangular Black, On - Off - On 3 terminal Replaces: 15905, 159-5 Amps 7.5 / 10 amps Volts 125 / 250 Mount Snap in	ES15907 Panel Rocker Switch Rectangular White, On - On 3 terminal Replaces: 15907, 159-7 Amps 15 amps Volts 125 / 250 Mount Snap in
				
ES16100 Appliance Switch SPST - Normally Open .250 Pushon Replaces: 16100, 161, 793085 WD21X557, 3135-0006 Amps 15 amps Volts 125 / 250 Mount Snap in	ES16200 Appliance Switch SPDT - .250 Pushon Threaded or Bolt Replaces: 16200, 162 Amps 15 amps Volts 125 / 250 Mount Snap in	ES16300 Appliance Switch SPDT - .250 Pushon Lever included Replaces: 16300, 163 Amps 15 amps Volts 125 / 250 Mount Snap in	ES16301 Appliance Switch SPDT - .250 Pushon Lever included Replaces: 16301, 163-1 Amps 15 amps Volts 125 / 250 Mount Snap in	ES16400 Appliance Switch DPDT - .250 Pushon Lever included Replaces: 16400, 164 Amps 15 amps Volts 125 / 250 Mount Snap in
				

Part numbers and illustrations are intended solely for identification. Items offered for sale are not represented to be manufactured by the company that built the original equipment manufacturer, actual product may vary from illustration.

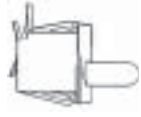
<p>ES16600 Appliance Switch</p> <p>SPDT - .250 Pushon Longer Stem Switch</p> <p>Replaces: 16600, 166, 303919</p> <p>Amps 15 amps Volts 125 / 250 Mount Bolt</p> 	<p>ES16700 Appliance Switch</p> <p>GE Dryer WE4X197</p> <p>Replaces: 16700, 167</p> <p>Amps 1 amp Volts 125 / 250 Mount Push-in</p> 	<p>ES16801 Appliance Switch</p> <p>GE Dryer WE4X199</p> <p>Replaces: 16801, 168-1</p> <p>Power 4 amps 1/3 hp Volts 125 / 250 Mount Push-in</p> 	<p>ES16802 Appliance Switch</p> <p>Icemaker, Microwave, Vending 3/16" Terminals.</p> <p>Replaces: 16802, 168-2</p> <p>Amps 15 amps Volts 125 / 250 Mount Bolt</p> 	<p>ES16803 Appliance Switch</p> <p>Electrolux Dryer Switch Q000165344</p> <p>Replaces: 16803, 168-3</p> <p>Amps 10 / 5 amps Volts 125 / 250 Mount Threaded</p> 
<p>ES16806 Appliance Switch</p> <p>Dryer Door Switch Fits both Older and Newer models</p> <p>Replaces: 16806, 168-6, 304575, 304576</p> <p>Amps 10 / 5 amps Volts 125 / 250 Mount Snap in</p> 	<p>ES16807 Appliance Switch</p> <p>SPST Heavy Duty Switch, typically used on S.Q, Maytag, & Commercial</p> <p>Replaces: 16807, 168-7, 06163 53236, 305754</p> <p>Amps 25 amps Volts 125 / 250 Mount Bolt</p> 	<p>ES16814 Appliance Switch</p> <p>Acts like lever or roller Vending, Microwave, 3/16" Terminals.</p> <p>Replaces: 16814, 168-14, 625851, 627512</p> <p>Amps 15 amps Volts 125 / 250 Mount Snap in</p> 	<p>DW440 Dishwasher Switch</p> <p>SPDT Heavy Duty Switch, typically used on GE Dishwashers, and others.</p> <p>Replaces: WD6X183</p> <p>Amps 25 amps Volts 125 / 250 Mount Snap in</p> 	<p>DE947 Commercial Laundry</p> <p>SPDT Heavy Duty Switch, typically used on S.Q, Huebsch, & Greenwald</p> <p>Replaces: M400947, M900952</p> <p>Amps 20 amps Volts 125 / 250 Mount Snap in</p> 
<p>LP173 Washer & Dryer Lid Switch and Bracket</p> <p>Typically used on Whirlpool, Sears, Roper, & Kitchenaid</p> <p>Replaces: 279173 4319330, 660308</p> <p>Amps 25 amps Volts 125 / 250 Mount Bolt</p> 	<p>LP210 Washer & Dryer Lid Switch and Bracket</p> <p>Typically used on Whirlpool, GE, & Kitchenaid</p> <p>Replaces: 279347, WE4X814 WE4X866</p> <p>Amps 25 amps Volts 125 / 250 Mount Bolt</p> 	<p>LP211 Washer Lid Switch</p> <p>Typically used on GE, Plated steel frame.</p> <p>Replaces: WH12X494</p> <p>Amps 20 / 10 amps Volts 125 / 250 Mount Bolt</p> 	<p>ES18100 Refrigerator / Freezer Light</p> <p>Easy snap in horizontal mount, with .250 push on terminals</p> <p>Replaces: 18100, 181</p> <p>Amps 1.5 / 4 amps Volts 125 / 250 Mount Snap in</p> 	<p>ES18200 Refrigerator / Freezer Fan</p> <p>Easy snap in horizontal mount, with .250 push on terminals</p> <p>Replaces: 18200, 182</p> <p>Amps 1.5 / 4 amps Volts 125 / 250 Mount Snap in</p> 
<p>ES18300 Refrigerator / Freezer Fan & Light</p> <p>Easy snap in horizontal mount</p> <p>Replaces: 18300, 183</p> <p>Amps 1.5 / 4 amps Volts 125 / 250 Mount Snap in</p> 	<p>ES18500 Refrigerator / Freezer Fan & Light</p> <p>White, Vertical mount 3 Terminal</p> <p>Replaces: 18500, 185</p> <p>Amps 10 / 5 amps Volts 125 / 250 Mount Snap in</p> 	<p>ES18600 Refrigerator / Freezer Fan</p> <p>Momentary contact Push on</p> <p>Replaces: 18600, 186</p> <p>Amps .75 / .25 amps Volts 125 / 250 Mount Threaded</p> 	<p>ES18700 Domestic Commercial</p> <p>Universal door switch Gibson, Used on Commercial walk ins</p> <p>Replaces: 18700, 187</p> <p>Amps .25 / .75 amps Volts 125 / 250 Mount Threaded</p> 	<p>ES18801 Domestic Commercial</p> <p>Color coded Red body fan switch. Used for 30 years</p> <p>Replaces: 18801, 188-1</p> <p>Amps 5 / 2.5 amps Volts 125 / 250 Mount Snap in</p> 

Part numbers and illustrations are intended solely for identification. Items offered for sale are not represented to be manufactured by the company that built the original equipment manufacturer, actual product may vary from illustration.



ES18802 Refrigerator / Freezer Light	ES18803 Refrigerator / Freezer Fan & Light	ES18804 Refrigerator / Freezer Fan & Light	ES18805 Refrigerator / Freezer Fan	ES18806 Refrigerator / Freezer Light
Color coded Black body light switch. Used for 30 years	White, Horizontal mount 4 Terminal, 2 circuit	White, Vertical mount 4 Terminal, 2 circuit	White Rectangular , Easy snap in design	White Rectangular , Easy snap in design
Replaces: 18802, 188-2	Replaces: 18803, 188-3	Replaces: 18804, 188-4	Replaces: 18805, 188-5	Replaces: 18806, 188-6
Amps 5 / 2.5 amps	Amps 5 / 2.5 amps	Amps 4 / .75 amps	Amps 5 / 2.5 amps	Amps 5 / 2.5 amps
Volts 125 / 250	Volts 125 / 250	Volts 125 / 250	Volts 125 / 250	Volts 125 / 250
Mount Snap in	Mount Snap in	Mount Snap in	Mount Snap in	Mount Snap in
				
ES18807 Refrigerator / Freezer Light	ES18809 Refrigerator / Freezer Fan	ES18810 Refrigerator / Freezer Light	ES18811 Refrigerator / Freezer Fan & Light	ES18812 Refrigerator / Freezer Fan & Light
Direct Replacement	Easy installation	Easy installation	SPDT Heavy Duty Switch, typically used on GE Dishwashers, and others.	3 Terminals
Replaces: 18807, 188-7	Replaces: 18809, 188-9	Replaces: 18810, 188-10	Replaces: 18811, 188-11	Replaces: 18812, 188-12
Amps 5 / 2.5 amps	Amps 5 / 2.5 amps	Amps 5 / 2.5 amps	Amps 5 / 2.5 amps	Amps 10 amps
Volts 125 / 250	Volts 125 / 250	Volts 125 / 250	Volts 125 / 250	Volts 125 / 250
Mount Snap in	Mount Snap in	Mount Snap in	Mount Snap in	Mount Snap in
				
ES18813 Refrigerator / Freezer Fan & Light	ES18814 Refrigerator / Freezer Fan & Light	ES18815 Refrigerator / Freezer Light	ES18817 Refrigerator / Freezer Fan	ES18818 Compactor & Furnace Switch
4 terminal	4 terminal	Longer shaft	Whirlpool 2149705	Maytag 4149377
Replaces: 18813, 188-13	Replaces: 18814, 188-14	Replaces: 18815, 188-15	Replaces: 18817, 188-17	Replaces: 18818, 188-18
Amps 4 / 1.5 amps	Amps 5 / 2.5 amps	Amps 1/2 amps	Amps 5 / 2.5 amps	Amps 11 / 5.5 amps
Volts 125 / 250	Volts 125 / 250	Volts 125 / 250	Volts 125 / 250	Volts 125 / 250
Mount Snap in	Mount Snap in	Mount Snap in	Mount Snap in	Mount Snap in
				

Part numbers and illustrations are intended solely for identification, Items offered for sale are not represented to be manufactured by the company that built the original equipment manufacturer, actual product may vary from illustration.

Appliance Bulbs

Appliance, Refrigerator, Oven Lamps/Bulbs

SUPCO Part No.	GEM No.	ROBERTSHAW No.	Watts	Volts	Bulb Shape	Packaged Quantity	Description/ Base
15T7C	LT006	87-006	15W	130V	T	25	Clear/Candelabra
15T7DC	LT007	87-007	15W	130V	T	25	Clear/Bayonet D.C.
25T61/2	LT008	87-008	25W	130V	T	25	Clear/Intern. Screw
25T61/2DC	LT009	87-009	25W	130V	T	25	Clear/Bayonet D.C.
25T8N	LT010	87-010	25W	130V	T	25	Clear/Intern. Screw
25T8DC	LT011	87-011	25W	130V	T	25	Clear/Bayonet D.C.
40A15	LT012	87-012	40W	130V	A	100	Gen'l Purpose/Med.
40T61/2	LT013	87-013	40W	130V	T	25	Clear/Intern. Screw
40T10	LT014	87-014	40W	130V	T	25	Clear/Med. Screw
40T10IF	LT018	87-018	40W	130V	T	25	Frstd./Intern. Screw
Pilot and Indicator Lamps/Bulbs							
6S6	LT001	87-00	6W	130V	S	50	Clear/Candelabra
6S6DC	LT002	87-002	6W	130V	S	50	Clear/Bayonet D.C.
7C7	LT003	87-003	7W	130V	C	50	Clear/Candelabra
10C7	LT004	87-004	10W	130V	C	50	Clear/Candelabra
10C7DC	LT005	87-005	10W	130V	C	50	Clear/Bayonet D.C.

