



# Prefabricated Sheet Metal Ducts & Fittings

## *Nebraska Division*

2073 N. Rademakers Way • Fremont, NE 68025  
(800) 801-0336 • (402) 753-9290

# Southwark Metal Mfg. Co. Nebraska Division

## PRODUCT CATEGORY INDEX

PAGE	DESCRIPTION
4	Snaplock Pipe
5	Elbows, Angles, & Register Boots
6-7	Trunk Duct and Fittings
8-9	Trunk Duct Fittings & Installation Accessories
10-11	Oval Pipe & Fittings
12-13	Wall Stack & Fittings
14-15	Sheet Metal & Fiberglass Takeoffs
16	Sheet Metal & Fiberglass Collars
17	Air-Tite Takeoffs
18-19	Accessories
20-21	Ceiling Outlets & Register Boxes
22	Venting Products
23	Black Pipe, Elbows, & Accessories

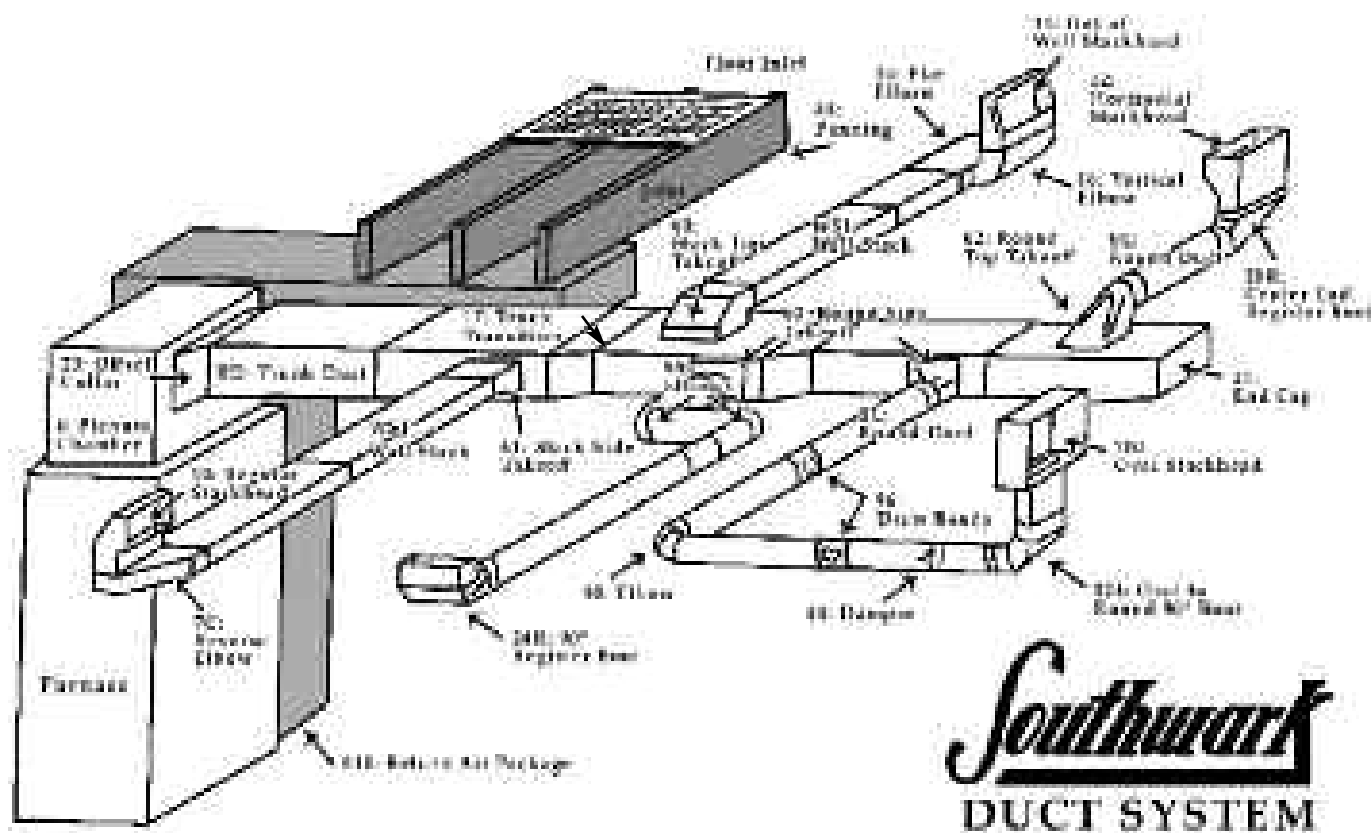

**Southwark**  
DUCT SYSTEM

# PRODUCT NUMBER INDEX

Item No.	Product Name	Page	Item No.	Product Name	Page	Item No.	Product Name	Page
31PF	Plaster Frame	21	1045	Flat Stack 45° Angle	12	2015	Round to Round Takeoff Fiberglass	15
37	Rigid S-Cleat (1/2" Leg)	9	1046	Flat Stack 90° Elbow	12	2016	Adj. Takeoff Fiberglass	15
39AL	Aluminum Wall Cap	22	1053	Flue Thimble	18	2018	Spin Collar w/Damper Fiberglass	16
39GP	Gray Plastic Wall Cap with Damper	22	1054	Panning Material (17x35)	9	2019	Spin Collar Fiberglass	16
39WP	White Plastic Wall Cap with Damper	22	1055	Panning Material (32x35)	9	2020	Ductboard Collar	16
44S	Damper - Fixed Hardware	19	1057	Storm Collar	19	2021	Ductboard Collar w/Damper	16
51F	Straight Ceiling Box w/Flange	21	1058	Tee Wye	18	2022	Round to Round Takeoff Fiberglass	15
51P	Straight Ceiling Box w/Plate	20	1059	Tee Joint- 24 & 26 Ga.	18	2023	Spin Collar w/Scoop Fiberglass	16
59F	90° Ceiling Box w/Flange	21	1059SW	Swivel Tee	18	2024	Spin Collar w/Scoop & Damper Fiberglass	16
59P	90° Ceiling Box w/Plate	20	1060	Free Flow Tee	18	4005	Aluminum Elbow	22
62	Top Takeoff Metal	14	1061	Y-Branch	18	4008	Aluminum Pipe	22
62FG	Top Takeoff Fiberglass	14	1062	Reducer- 3PC	19	AT62	Air-Tite Top Takeoff	17
63	Side Takeoff Metal	14	1063	Reducer- 2PC	19	AT62WD	Air-Tite Top Takeoff w/Damper	17
85	Insulated Ceiling Box - Top Outlet	21	1064	Tee Cap	19	AT63	Air-Tite Side Takeoff	17
85S	Insulated Ceiling Box - Side Outlet	21	1065	Drawband- Nuts & Bolts	18	AT63A	Air-Tite Adjustable Takeoff	17
87	Lever Takeoff Metal	14	1066	One Quad Damper	19	AT63WD	Air-Tite Side Takeoff w/Damper	17
97	Flat Collar- Crimped	16	1067	Two Quad Damper	19	ATD	Air-Tite Takeoff w/Damper	17
97LS	Long Style Flat Collar	16	1068	Floor Register Box- 5" Deep	21	ATDBM	Air-Tite Bellmouth Takeoff w/Damper	17
97NC	Flat Collar- No Crimp	16	1069	Floor Register Box- 10" Deep	21	ATDRP	Air-Tite Round Pipe Takeoff w/Damper	17
97LSWD	Flat Collar w/Damper	16	1070	Chimney Cap	18	ATHE	Air-Tite High Efficiency Takeoff	17
100	Oval Pipe- 100"	10	1070A	Vent Cap	18	ATHEWD	Air-Tite High Efficiency Takeoff w/ Damper	17
106	Oval to Round Reverse Boot	10	1071	Roof Flashing	19	ATS	Air-Tite Takeoff w/Scoop	17
110	Oval Stackhead	10	1071T	Tall Roof Flashing	19	ATSD	Air-Tite Takeoff w/Scoop & Damper	17
113	Flat Oval 45° Angle	10	1072	Adjustable Plenum Top	8	ATT	Air-Tite Takeoff Plain	17
114	Flat Oval 90° Elbow	10	1073	Adjustable Plenum Panel	8	ATTBM	Air-Tite Bellmouth Takeoff	17
115	Vertical Oval 45° Angle	11	1074	'A' Style Plenum	8	ATTRP	Air-Tite Round Pipe Takeoff	17
116	Vertical Oval 90° Elbow	11	1075	'B' Style Plenum	8	ATTRP45	Air-Tite 45° Saddle Takeoff	17
120SC	Snap Collar Metal	16	1076	Complete Adj. Plenum	8	BP12	Black Pipe- 12"	23
122SC	Snap Collar Fiberglass	16	1100	Stack Straight Collar	13	BP24	Black Pipe- 24"	23
124	Oval to Round 90° Boot	11	1100	Trunk Straight Collar	6	BP36	Black Pipe- 36"	23
124R	Oval 90° Register Boot	10	1101	Trunk Reducer	9	BP54	Black Tee Joint	23
127	Oval to Round Straight Boot	11	1101A	Trunk Reducer	9	BP55	Black Tee Cap	23
127R	Oval Straight Register Boot	10	1102	Trunk Reducer- Tapered to Side	7	BP58	Black Reducer- 3PC	23
128	Oval to Oval Reverse Boot	11	1103	Trunk Reducer- Tapered to Center	7	BP90	Black 90° Elbow	23
128R	Oval End Register Boot	10	1104	S-Cleat	9	BP96	Black Drawband	23
137	Drain Pan	8	1104R	Rigid S-Cleat (1" Leg)	9	BP127	Black Oval to Rd Adapter	23
150	Oval Stackhead w/Collar	10	1105	Drive Cleat	9	BPC	Black Pipe Collar	23
160	Oval Pipe- 60"	10	1106	Plaster Round	9	BPCHAD	Black Chimney Adapter	23
162	Oval Top Takeoff	11	1109	Trunk Transition Collar	7	BPCON	Black Connector	23
163	Oval Side Takeoff	11	1110	Stack End Cap	13	BPTC	Black Trim Collar	23
177	Ceiling Outlet	20	1110	Trunk End Cap	7	CID	Cast Iron Damper	23
177S	Ceiling Side Outlet	20	1111	Return Air Frame	9	EP13	Adjustable Takeoff Metal	15
201VH	Aluminum Wall Cap	22	1112	Plenum Corner	9	EP15	Round to Round	14
201VHWP	White Plastic Wall Cap	22	1113	8" Drive Cleat	9	EV141	Adjustable Takeoff Metal	14
207	90° Vent Saddle	18	1114	10" Drive Cleat	9	FR	Eave Vent	22
208	45° Vent Saddle	18	1115	Duct Hanger	9	HT15	Filter Rack	9
220EC	Eave Vent with Grille	22	1137	Register Collar	21	MF	Half Tab Takeoff Metal	14
239	Aluminum Roof Cap with Damper & Screen (4")	22	1140	Vertical Trunk 90° Elbow	6	MR	Aluminum Flexible Duct	22
240	Aluminum Roof Cap with Damper & Screen (up to 7")	22	1141	Vertical Trunk 45° Angle	6	OVP113	Mounting Rails	21
241	Aluminum Roof Cap with Damper & Screen (up to 10")	22	1145	Flat Trunk 45° Angle	6	OVP120	Oval Pipe - 113"	10
355	Oval Straight Register Box	11	1146	Flat Trunk 90° Elbow	6	PH3	Oval Pipe - 120"	10
360	Oval Angle Register Box	11	1147	Trunk Offset Collar	6	PH3L	End Register Boot	5
390WP	White Louver Hood with Tail	22	1151	Trunk Volume Damper	7	PH3R	End Register Boot-Left	5
391WP	Face Only	22	1161	Diffuser Outlet w/Flange	20	PH4	End Register Boot-Right	5
924	Wallstack- 24"	12	1163	Diffuser Outlet	20	PH5	90° Register Boot	5
960	Wallstack- 60"	12	1166	Sq. to Rd. w/Flange	20	PH7	90° Basement Head Boot	5
970	Wallstack- 100"	12	1170	Diffuser Tee w/Flange	20	PHXT	Straight Register Boot	5
1005	90° Adjustable Elbow	5	1172	Vertical Draft Vent	19	RV51	PH Extension 10" Long	13
1006	45° Adjustable Angle	5	1221	Horizontal Draft Vent	19	SAL	Aluminum Roof Cap with Screen (up to 8")	22
100824	Round Pipe-24"	4	1221B	Return Air Package	8	S5	Aluminum Transition Duct	22
100860	Round Pipe-60"	4	1222	Cold Air Boot	8	S75	Pivot Takeoff Metal	15
1008120	Round Pipe-120"	4	1222B	Return Air Package	8	SB30	Drawband- Snappy	18
1019	End Stack Boot	12	1223	Cold Air Boot	8	SB38	Return Air Support Box	9
1020	90° Stack Boot	12	1223B	Cold Air Boot	8	SAL	Return Air Support Box	9
1024	Straight Stack Boot	12	1224	Return Air Package	8	SH	Aluminum Transition Duct	22
1031	Stackhead	13	1224B	Cold Air Boot	8	SPC	White Flexible Vinyl Hose	22
1031LT	Long Throat Stackhead	13	1259	Damper Section	19	SVH	Pipe Clamp	22
1031WE	Long Throat Stackhead w/Ears	13	1348	Spin Collar w/Damper Metal	16	SVHBP	Aluminum Vent Hood	22
1034	Horizontal Stackhead	13	1349	Spin Collar w/Scoop & Damper Metal	16	SVHWP	Brown Plastic Vent Hood	22
1040	Vertical Stack 90° Elbow	12	1350	Spin Collar w/Scoop Metal	16	TD	White Plastic Vent Hood	22
1041	Vertical Stack 45° Angle	12	1351	Spin Collar Metal	16		Trunk Duct	6
1042	Funnel Register Box	20	1606	Aluminum Vent Hood	19			
			1706	Galvanized Vent Hood	19			
			2013	Adj. Takeoff Fiberglass	15			
			2014	Side Takeoff Fiberglass	15			

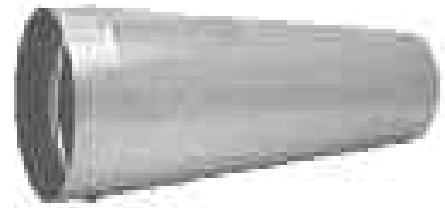

**No. 100824**

2 FT PIPE - 30, 26 & 24 GAUGE

No tools required to assemble Snaplock Pipe. Simply start at one end and easily snap pipe together. One person can quickly assemble up to 10 ft. lengths.

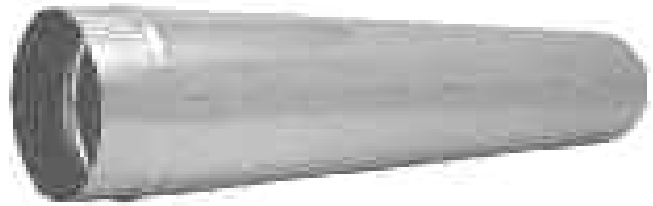

**No. 100860**

5 FT PIPE - 30 & 26 GAUGE

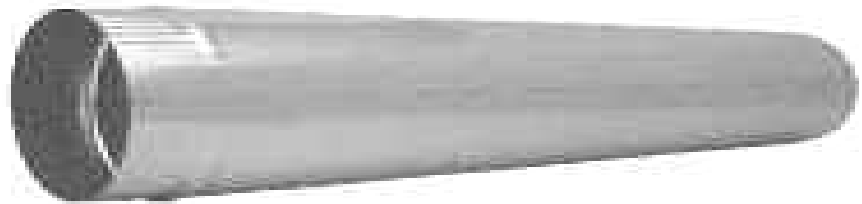

**No. 1008120**

10 FT PIPE - 30 GAUGE



Self starting crimp is knurled sufficiently so that the crimp "falls in" and yet, once assembled completes a rigid, leak proof connection.



**No. 1005**  
90° ADJUSTABLE ELBOW



**No. 1006**  
45° ADJUSTABLE ANGLE



**No. PH4**  
90° REGISTER BOOT



**No. PH7**  
STRAIGHT  
REGISTER BOOT



**No. PH3**  
END REGISTER BOOT  
**No. PH3L** LEFT HAND  
**No. PH3R** RIGHT HAND



**No. PH5**  
90° BASEMENT BOOT

- 30", 36", 48", 60", and 96" Lengths.
- Furnished in Button Snaplock with S-Cleat & Drive Connections.
- Cross Broken for Extra Stiffening Strength.
- Square Throat Fittings are Standard. Radius is available upon request.



**No. TD**  
TRUNK DUCT



**No. 1145**  
FLAT 45° ANGLE



**No. 1146**  
FLAT 90° ELBOW



**No. 1141**  
VERTICAL 45° ANGLE



**No. 1140**  
VERTICAL 90° ELBOW



**No. 1100**  
STRAIGHT COLLAR



**No. 1147**  
OFFSET COLLAR

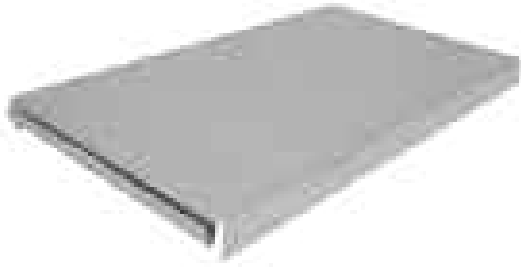

**No. 1110**  
END CAP



**No. 1109**  
TRANSITION COLLAR

1109 TRANSITION COLLAR	
DUCT SIZE	PLENUM OPENING (width x height)
8x8	8x10
10x8	8x10
12x8	10x10
14x8	10x12
16x8	10x13
18x8	10x15
20x8	10x16
22x8	10x18
24x8	10x20
26x8	12x18
28x8	12x18
30x8	12x20
32x8	14x20

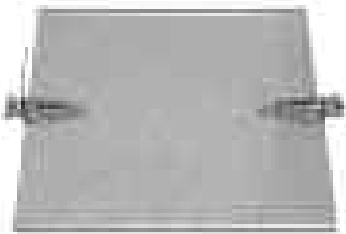

**No. 1151**  
VOLUME DAMPER



**No. 1102**  
TRUNK REDUCER  
TAPERED to ONE SIDE



**No. 1103**  
TRUNK REDUCER  
TAPERED to CENTER

**No. 1072**  
ADJ. PLENUM TOP



**No. 1076**  
COMPLETE  
ADJ. PLENUM

**ADJUSTABLE PLENUMS**

AVAILABLE TO ORDER  
(Actual plenum height,  
2" less than listed size)

TO INSTALL...

- (1) Cut raw edges of side panels to desired width and height sizes.
- (2) Trim top to desired width and depth dimensions.
- (3) Assemble 3 sides, slide top into side panel pockets, then position fourth side.
- (4) Secure assembly with sheet metal screws.

**No. 1073**  
ADJ. PLENUM SIDE



COLD  
AIR  
BOOT

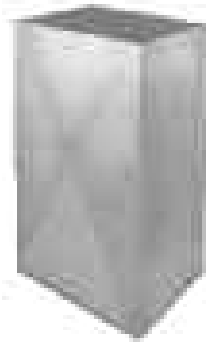

**No. 1074**  
'A' STYLE PLENUM



**No. 1075**  
'B' STYLE PLENUM

**RETURN AIR PACKAGE**

Complete package  
consisting of:  
1 - Starting Collar  
2 - 30" Duct Sections  
1 - R.A. Plenum with  
1" Filter Rack  
6 - 10" Drive Straps  
*Shipped K.D. in One Carton*

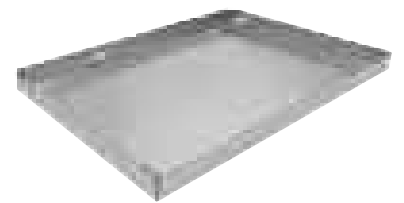

**No. 137**  
DRAIN PAN

RA PKG	DUCT SIZE	BOOT ONLY
1221	20 x 10 - 20 x 16	1221B
1222	25 x 10 - 25 x 16	1222B
1223	20 x 10 - 20 x 14	1223B
1224	25 x 10 - 25 x 14	1224B





**No. 1113**  
8" DRIVE CLEAT  
**No. 1114**  
10" DRIVE CLEAT



**No. 1105**  
DRIVE CLEAT



**No. 1104**  
S-CLEAT

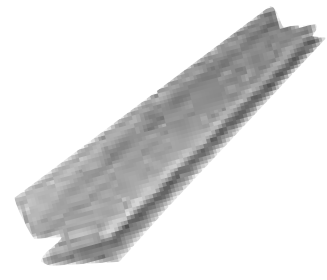

**No. 1104R**  
RIGID S-CLEAT (1" Leg)  
**No. 37**  
RIGID S-CLEAT (1/2" Leg)



**No. 1115**  
10" DUCT HANGER

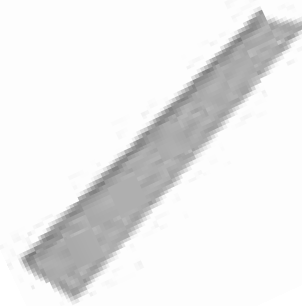

**No. 1106**  
PLASTER ROUND

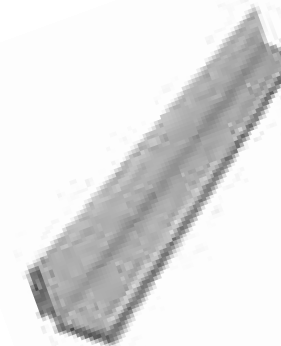

**No. 1112**  
PLENUM  
CORNER

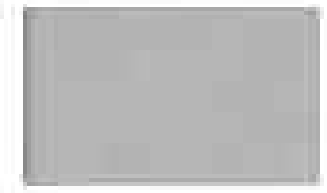

**No. 1054 (17 x 35)**  
PANNING MATERIAL  
**No. 1055 (32 x 35)**  
PANNING MATERIAL



**No. FR**  
FILTER RACK



**No. 1111**  
RETURN AIR  
FRAME



**No. 1101**  
TRUNK REDUCER



**No. 1101A**  
TRUNK REDUCER

**RETURN AIR/SUPPORT BOX**

	<b>SB30</b>	<b>SB38</b>
A DIMENSION	30"	38"
B DIMENSION	20"	26"
RETURN AIR DUCT SIZE	8 x 24	10 x 25

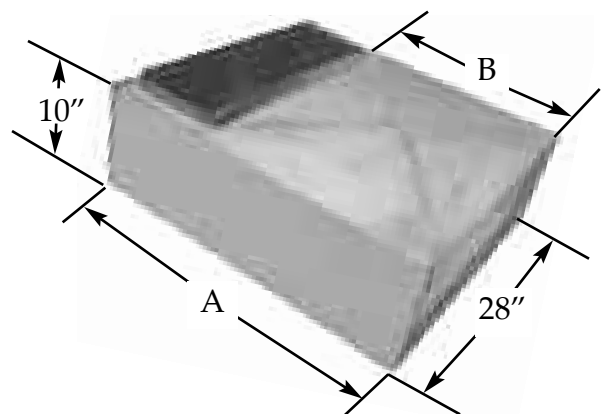

RETURN AIR/SUPPORT BOX

**No. 100**  
OVAL PIPE 100" - 30 Ga.

**No. OVP113**  
OVAL PIPE 113" - 30 Ga.

**No. OVP120**  
OVAL PIPE 120" - 30 Ga.

**No. 160**  
OVAL PIPE 60" - 30 Ga.

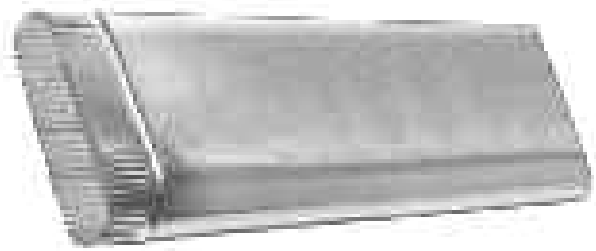

**No. 113**  
FLAT 45° ANGLE



**No. 114**  
FLAT 90° ELBOW



**No. 110**  
OVAL STACKHEAD

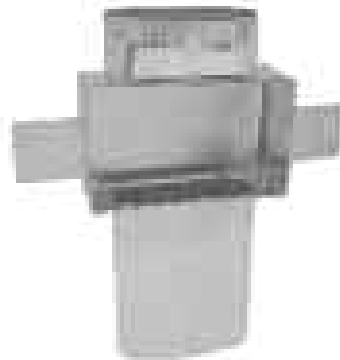

**No. 150**  
STACKHEAD w/COLLAR



**No. 106**  
OVAL to ROUND  
REVERSE BOOT



**No. 124R**  
90° REGISTER BOOT



**No. 127R**  
STRAIGHT  
REGISTER BOOT



**No. 128R**  
END REGISTER BOOT

**WALL STACK VS. OVAL PHYSICAL COMPARISON**

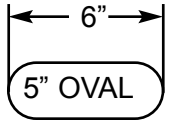
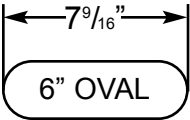
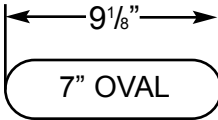
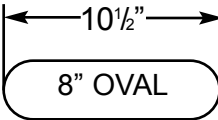
 <p>5" OVAL</p> <p>3 1/4" X 8"</p>	 <p>6" OVAL</p> <p>3 1/4" X 10"</p>	 <p>7" OVAL</p> <p>3 1/4" X 12"</p>	 <p>8" OVAL</p> <p>3 1/4" X 14"</p>
---	--	---	--



**No. 115**  
VERTICAL 45° ANGLE



**No. 116**  
VERTICAL 90° ELBOW



**No. 162**  
OVAL TOP TAKEOFF



**No. 127**  
OVAL to ROUND  
STRAIGHT BOOT



**No. 124**  
OVAL to ROUND  
90° BOOT



**No. 163**  
OVAL SIDE TAKEOFF



**No. 128**  
OVAL to OVAL  
REVERSE BOOT



**No. 355**  
STRAIGHT OVAL  
REGISTER BOX



**No. 360**  
ANGLE OVAL  
REGISTER BOX

- 24", 48", 60" & 100" Lengths
- Furnished in Button Snaplock
- Two Pieces Per Section
- No Tools and No Indentations,  
Just Snap It and It's Closed



**WALLSTACK**

- No. 924** - 24" Length
- No. 948** - 48" Length
- No. 960** - 60" Length
- No. 970** - 100" Length



**No. 1020**  
90°  
STACK BOOT



**No. 1024**  
STRAIGHT  
STACK BOOT



**No. 1019**  
END  
STACK BOOT



**No. 1045**  
FLAT 45° ANGLE



**No. 1046**  
FLAT 90° ELBOW

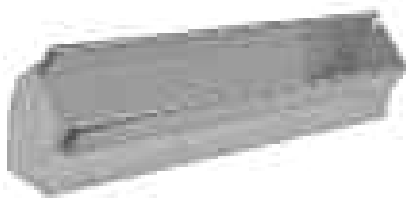

**No. 1041**  
VERTICAL 45° ANGLE

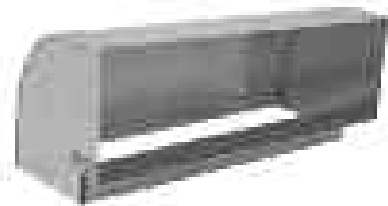

**No. 1040**  
VERTICAL 90° ELBOW



**No. 1100**  
WARM AIR COLLAR



**No. PHEXT**  
PH EXTENSION  
10" LONG

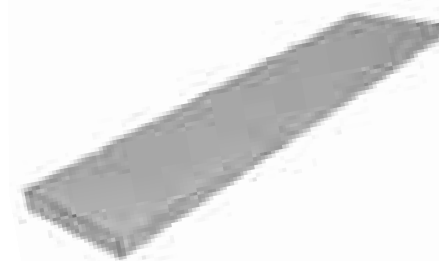

**No. 1110**  
END CAP

## STACKHEADS

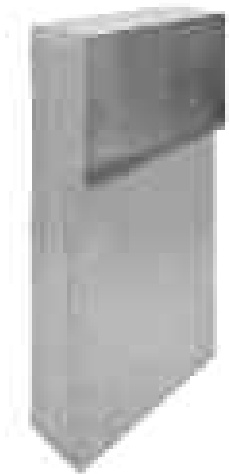

**No. 1031LT**  
LONG THROAT STACKHEAD



**No. 1031WE**  
LONG THROAT  
STACKHEAD w/EARS



**No. 1031**  
STACKHEAD



**No. 1034**  
HORIZONTAL  
STACKHEAD



**No. 62**  
SHEET METAL  
TOP TAKEOFF

Pipe Size	Base Opening
4"	4 x 6
5"	5 x 6
6"	6 x 6
7"	7 x 8
8"	8 x 8
9"	10 x 10
10"	11½ x 10
12"	12 x 12
14"	14 x 14

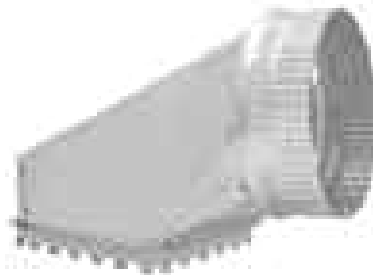

**No. 62FG**  
FIBERGLASS TOP  
TAKEOFF

Pipe Size	Base Opening
4"	4 x 6
5"	5 x 6
6"	6 x 6
7"	7 x 8
8"	8 x 8
9"	10 x 10
10"	11½ x 10
12"	12 x 12
14"	14 x 14

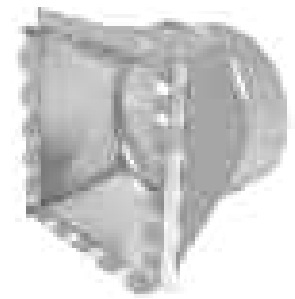

**No. 63**  
SHEET METAL  
SIDE RD TAKEOFF

Pipe Size	Base Opening
4"	6 x 6
5"	6 x 6
6"	6 x 6
7"	6 x 8
8"	6 x 10
9"	7 x 12
10"	7 x 14
12"	8 x 18
14"	8 x 20

**No. 62NT**  
SHEET METAL TOP  
TAKEOFF - NO TABS

Pipe Size	Base Opening
4"	4 x 6
5"	5 x 6
6"	6 x 7
7"	7 x 8
8"	8 x 8



**62ENT**  
SHEET METAL TOP  
TAKEOFF - NO TABS

Pipe Size	Base Opening
5"	5 x 5
6"	5 x 7

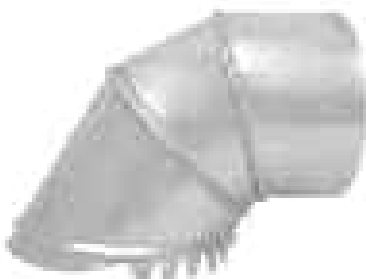

**No. HT15**  
SHEET METAL RD to RD  
HALF TAB TAKEOFF

Pipe Size	Base Opening
4"	5"
5"	6"
6"	7"
7"	8"



**No. EP15**  
SHEET METAL RD to RD  
ADJUSTABLE TAKEOFF

Pipe Size	Base Opening
5"	6"
6"	7"
7"	8"
8"	9"



**No. 87**  
SHEET METAL  
LEVER TAKEOFF

Pipe Size	Base Opening
5"	6"
6"	7"
7"	8"



**No. 2014**  
FIBERGLASS  
SIDE TAKEOFF



**No. EP13**  
SHEET METAL  
ADJ. RD. TAKEOFF



**No. 2016**  
FIBERGLASS  
ADJ. TAKEOFF



**No. 2013**  
FIBERGLASS  
ADJ. TAKEOFF

Pipe Size	Base Opening
4"	6 x 6
5"	6 x 6
6"	6 x 6
7"	6 x 8
8"	6 x 10
9"	7 x 12
10"	7 x 14
12"	8 x 18
14"	8 x 20

Pipe Size	Base Opening
4"	4 x 6
5"	5 x 6
6"	6 x 7
7"	7 x 8
8"	7 x 10
9"	9 x 11
10"	10 x 12
12"	12 x 16
14"	14 x 19

Pipe Size	Base Opening
4"	4 x 6
5"	5 x 6
6"	6 x 7
7"	7 x 8
8"	7 x 10
9"	9 x 11
10"	10 x 12
12"	12 x 16
14"	14 x 19

Pipe Size	Base Opening
4"	4 x 6
5"	5 x 6
6"	6 x 7
7"	7 x 8
8"	7 x 10
9"	9 x 11
10"	10 x 12
12"	12 x 16
14"	14 x 19



**No. S5**  
SHEET METAL  
PIVOT TAKEOFF

Pipe Size	Base Opening
5"	6"
6"	7"
7"	8"



**No. 2015**  
FIBERGLASS  
RD. to RD. TAKEOFF



**No. 2022**  
FIBERGLASS  
RD. to RD. TAKEOFF

Pipe Size	Base Opening
5"	6"
6"	7"
7"	8"
8"	9"

**SHEET METAL COLLARS**



**No. 120SC**  
SNAP COLLAR



**No. 97**  
FLAT COLLAR  
**No. 97NC**  
NO CRIMP COLLAR



**No. 97LS**  
LONG FLAT COLLAR  
**No. 97LSWD**  
COLLAR w/DAMPER

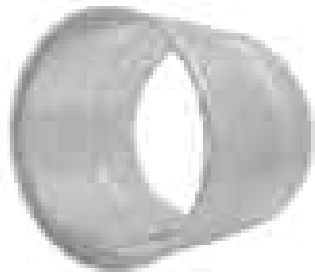

**No. 1351**  
SPIN FITTING



**No. 1348**  
SPIN FITTING  
w/DAMPER



**No. 1350**  
SPIN FITTING  
w/SCOOP



**No. 1349**  
SPIN FITTING  
w/SCOOP & DAMPER

**FIBERGLASS COLLARS**



**No. 2020**  
COLLAR  
**No. 2021**  
COLLAR w/DAMPER



**No. 122SC**  
SNAP COLLAR



**No. 2019**  
SPIN COLLAR



**No. 2018**  
SPIN COLLAR  
w/DAMPER



**No. 2023**  
SPIN COLLAR  
w/SCOOP



**No. 2024**  
SPIN COLLAR  
w/SCOOP & DAMPER





**No. ATT**  
TAKEOFF  
PLAIN



**No. ATD**  
TAKEOFF  
w/DAMPER



**No. ATS**  
TAKEOFF  
w/SCOOP



**No. ATSD**  
T.O. w/SCOOP  
& DAMPER



**No. ATTRP**  
RD. PIPE TAKEOFF  
**No. ATDRP**  
w/DAMPER



**No. AT62**  
TOP TAKEOFF  
**No. AT62WD**  
w/DAMPER



**No. AT63A**  
ADJUSTABLE  
RD. TAKEOFF



**No. ATTRP45**  
45° SADDLE  
TAKEOFF



**No. ATTBM**  
BELLMOUTH TAKEOFF  
**No. ATDBM**  
w/DAMPER



**No. AT63**  
RECTANGULAR TAKEOFF  
**No. AT63WD**  
w/DAMPER



**No. ATHE**  
HIGH EFFICIENCY TAKEOFF  
**No. ATHEWD**  
w/DAMPER

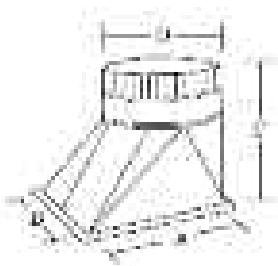

Pipe Size	Base Opening
4"	6 x 6
5"	6 x 6
6"	6 x 6
7"	6 x 8
8"	6 x 10
9"	7 x 12
10"	7 x 14
12"	8 x 18
14"	8 x 20

SIZE	A	B	C	D
5"	10"	6"	10"	5"
6"	10"	6"	10"	6"
7"	10"	6"	10½"	7"
8"	12"	8"	11"	8"
9"	12"	9"	11"	9"
10"	14"	10"	11"	10"
12"	18"	12"	13"	12"
14"	18"	12"	13"	14"

- Tees and Wyes
- Reducers
- Dampers
- Vents
- Drawbands
- Flashing
- Connectors



**No. 207**  
90° VENT SADDLE



**No. 208**  
45° VENT SADDLE

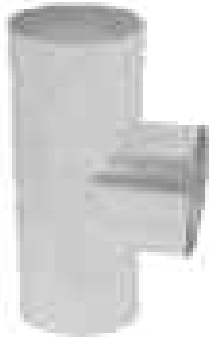

**No. 1059**  
TEE JOINT  
26 & 24 Gauge



**No. 1060**  
FREE FLOW TEE



**No. 1058**  
TEE WYE



**No. 1059SW**  
SWIVEL TEE



**No. 1070**  
CHIMNEY CAP



**No. 1070A**  
VENT CAP



**No. 1053**  
FLUE THIMBLE



**No. 1061**  
Y-BRANCH



**No. S75**  
DRAWBAND



**No. 1065**  
DRAWBAND



**No. 1064**  
TEE CAP  
Available Crimped



**No. 1062**  
3 Pc. REDUCER  
Available Crimped



**No. 1063**  
2 Pc. REDUCER



**No. 1172**  
HORIZONTAL  
DRAFT VENT

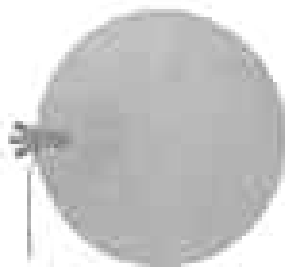

**No. 44S**  
ROUND DAMPER  
FIXED HARDWARE



**No. 1066**  
ONE QUAD  
DAMPER

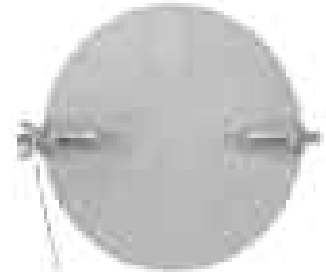

**No. 1067**  
TWO QUAD  
DAMPER



**No. 1170**  
VERTICAL  
DRAFT VENT

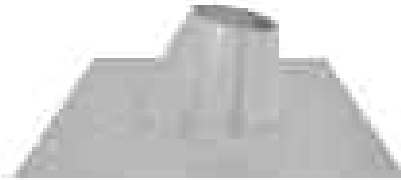

**No. 1071**  
ROOF FLASHING

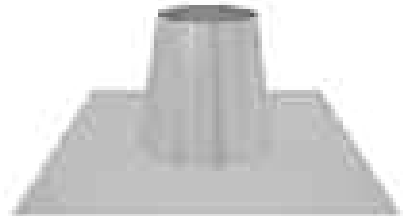

**No. 1071T**  
TALL FLASHING



**No. 1259**  
DAMPER SECTION



**No. 1706**  
GALVANIZED VENT HOOD  
(Available without Damper - No. 1705)

**No. 1606**  
ALUMINUM VENT HOOD  
(Available without Damper - No. 1605)



**No. 1057**  
STORM COLLAR

# Ceiling Outlets & Register Boxes



**No. 177**  
CEILING OUTLET



**No. 177S**  
SIDE OUTLET



**No. 1161**  
DIFFUSER FUNNEL  
w/FLANGE



**No. 1163**  
DIFFUSER OUTLET  
SQUARE TO ROUND w/FLANGE



**No. 1166**  
DIFFUSER TEE  
w/FLANGE



**No. 1042**  
FUNNEL REGISTER BOX  
w/FLANGE



**No. 51P**  
STRAIGHT CEILING BOX  
w/PLATE



**No. 59P**  
90° ANGLE CEILING BOX  
w/PLATE

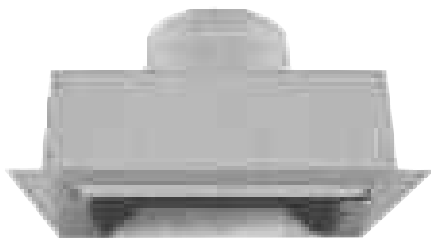

**No. 85**  
INSULATED CEILING  
BOX TOP OUTLET



**No. 85S**  
INSULATED CEILING  
BOX SIDE OUTLET

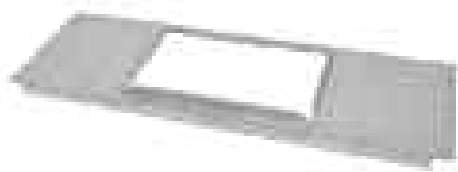

**No. 31PF**  
PLASTER FRAME



**No. MR**  
MOUNTING RAILS  
Note: Available 26" long



**No. 1137**  
REGISTER COLLAR



**No. 1068**  
FLOOR REGISTER BOX 5" DEEP  
**No. 1069**  
FLOOR REGISTER BOX 10" DEEP



**No. 51F**  
STRAIGHT CEILING BOX  
w/FLANGE



**No. 59F**  
90° CEILING BOX  
w/FLANGE



**No. SVH**  
ALUMINUM  
VENT HOOD  
**No. SVHBP**  
BROWN PLASTIC  
**No. SVHWP**  
WHITE PLASTIC

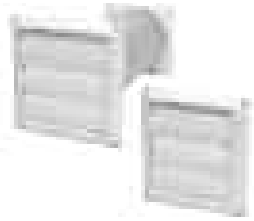

**No. 390WP**  
WHITE LOUVER  
HOOD w/TAIL  
**No. 391WP**  
FACE ONLY



**No. 4008**  
ALUMINUM PIPE



**No. 4005**  
ALUMINUM  
ELBOW



**No. SPC**  
PIPE CLAMP



**No. SH**  
FLEXIBLE  
WHITE VINYL HOSE



**No. MF**  
FLEXIBLE  
ALUMINUM DUCT



**No. SAL**  
ALUMINUM  
TRANSITION DUCT

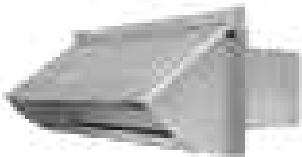

**No. 201VH**  
ALUMINUM  
WALL CAP  
**No. 201VHWP**  
WHITE PLASTIC



**No. 39GP**  
GRAY PLASTIC  
WALL CAP  
w/DAMPER  
**No. 39WP**  
WHITE PLASTIC



**No. 39AL**  
ALUMINUM  
WALL CAP  
w/DAMPER



**No. EV141**  
EAVE VENT



**No. RV51**  
ALUMINUM ROOF  
CAP w/SCREEN  
UP TO 8" ROUND

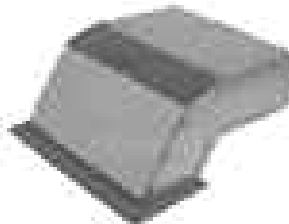

**No. 220EC**  
EAVE VENT  
w/GRILLE



ALUMINUM ROOF  
CAP w/DAMPER  
& SCREEN

**No. 239** - FITS 4" DIA.  
**No. 240** - UP TO 7" RD  
**No. 241** - UP TO 10" RD

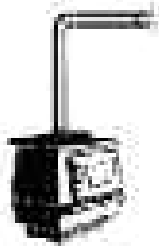

- Available in 5", 6", 7", & 8" Diameters
- 24 Gauge Material
- Heat and Rust Resistant
- Standard Packaging

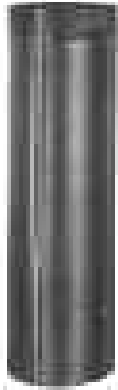

**No. BP**  
SNAPLOCK PIPE  
AVAILABLE 12", 24", 36" LENGTHS



**No. BP90**  
90° ADJUSTABLE ELBOW

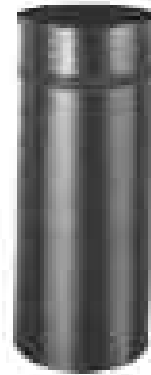

**No. BPCHAD**  
CHIMNEY ADAPTER



**No. BP127**  
OVAL to RD ADAPTER

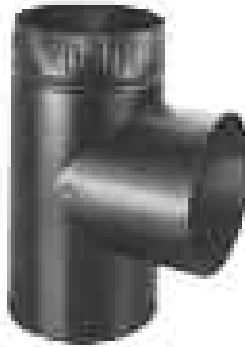

**No. BP54**  
TEE JOINT



**No. BP55**  
TEE CAP



**No. BP58**  
3 Pc. REDUCER



**No. BP96**  
DRAWBAND



**No. BPCON**  
CONNECTOR



**No. BPC**  
PIPE COLLAR



**No. BPTC**  
TRIM COLLAR



**No. CID**  
CAST IRON DAMPER

*Black Pipe, Elbows, & Accessories*

**Providing Quality Products,  
Superior Service and On-Time Delivery  
since 1946.**

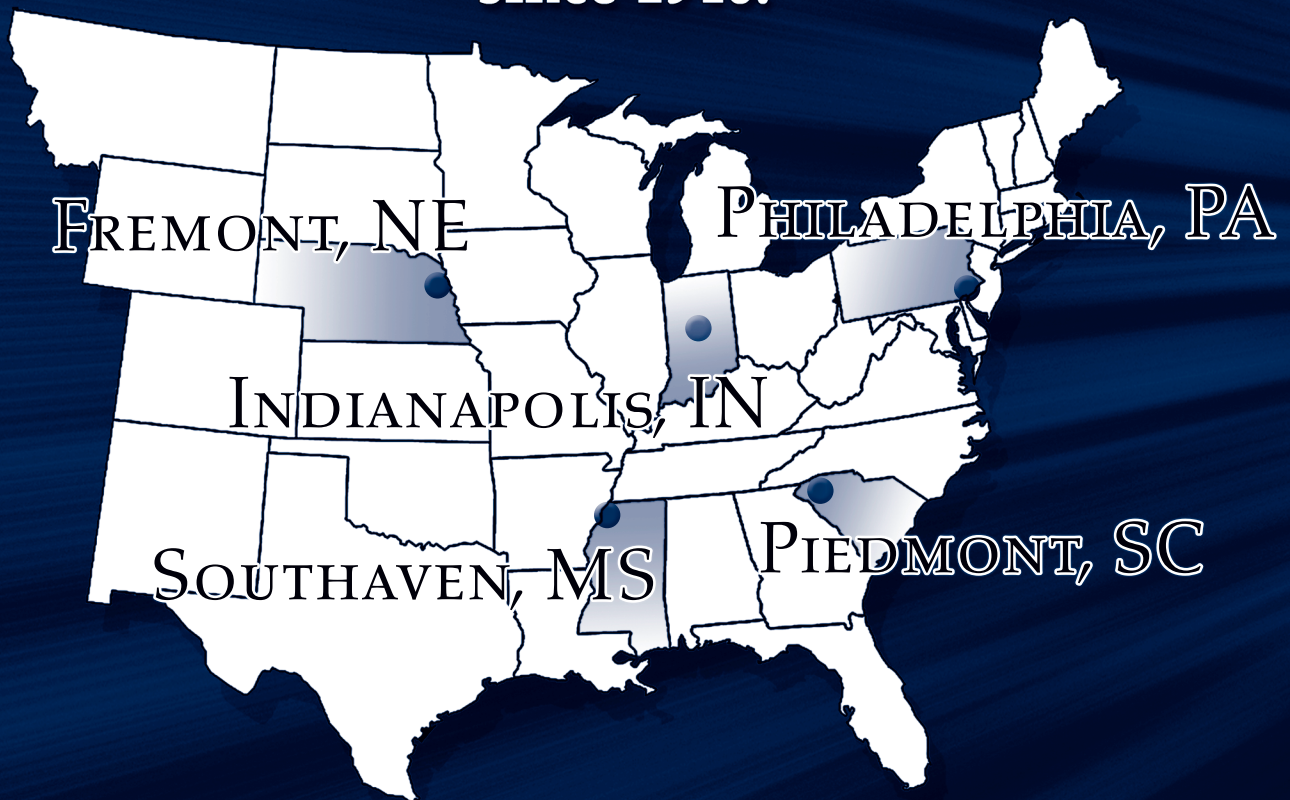

**Philadelphia Division**

Philadelphia, PA

(800) 523-1052

(800) 722-2076 Fax

**Greenville Division**

Piedmont, SC

(800) 229-2803

(864) 845-6190 Fax

**Indianapolis Division**

Indianapolis, IN

(800) 490-7707

(317) 823-1006 Fax

**Mississippi Division**

Southaven, MS

(800) 541-6706

(662) 393-8005 Fax

**Nebraska Division**

Fremont, NE

(800) 801-0336

(402) 753-9008 Fax

*[www.southwarkmetal.com](http://www.southwarkmetal.com)*