

# DiversiTech



HVAC  
PRODUCT  
CATALOG

ISSUE 20

1

PADS



29

AIR MOVEMENT



37

HEATING PRODUCTS



45

CONDENSATE MANAGEMENT



73

GENERAL INDUSTRIAL



85

DEVCO



121

ELECTRICAL



159

TOOLS



181

PLUMBING



193

DUCTLESS SYSTEMS



207

MAINTENANCE CHEMICALS



235

INLINE COMPONENTS



251

DISTRIBUTOR SUPPORT



# PADS

Anti-Vibration Pads.....	28
Cladlite® Lightweight Equipment Pads.....	22
E Lite® Plastic Equipment Pads.....	21
Enviropad™.....	25
Heat Pump Pads.....	25
Heat Pump Risers.....	26
Hef-T-Pad™.....	24
Mounting Bracket and Blocks.....	26-27
The Black Pad®.....	24
The Hurricane Pad™.....	23
Ultralite® Lightweight Concrete Equipment Pads...	20-21

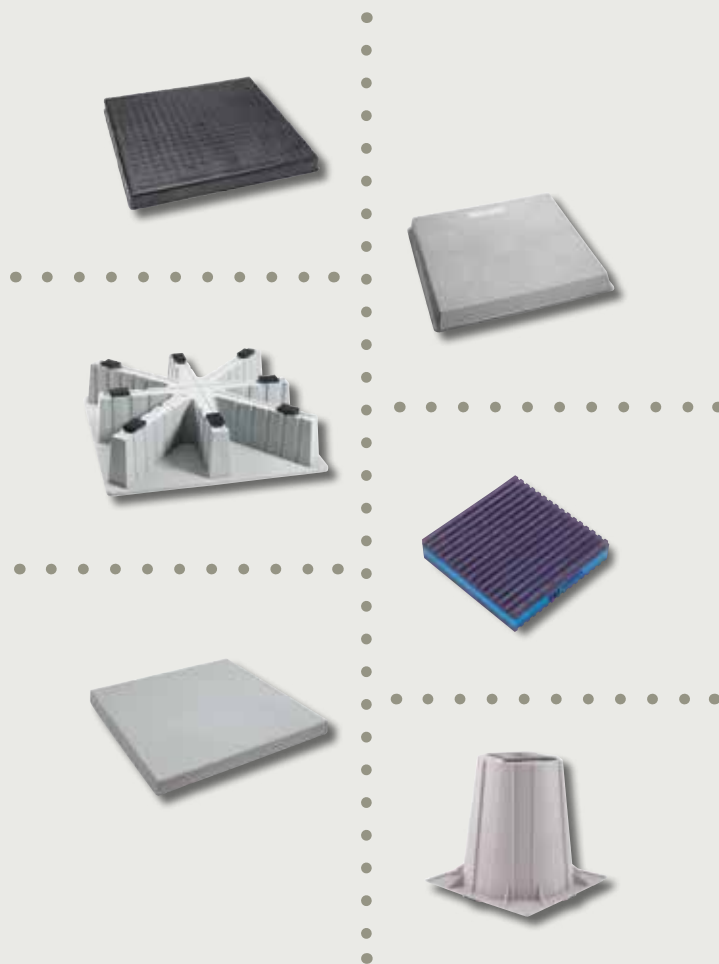

# E Lite<sup>®</sup> Plastic Equipment Pads

**E** Lite<sup>®</sup> is a plastic pad designed as a mounting base for air conditioning condensers. The rugged design provides uniform and generous ribbing for optimum, self-leveling ground support without inserts. E Lite<sup>®</sup> is injection molded from polypropylene, resulting in a pad that is lightweight, but not too light. A subtle texture prevents unit slide and presents a classic appearance, which is enhanced by rounded edges and a concrete gray color. Each pad is molded with its size in raised letters.



## TECHNICAL DATA

### MATERIAL

Polypropylene

### FREEZE/THAW

Flawless performance under the 25-cycle regimen specified by ASTM C67

### CHEMICAL RESISTANCE

Does not crack, flake, or warp when tested per ASTM D2299 with the following:

- R-22 and R-134a
- Synthetic canine urine
- Compressor oil
- Salt solution, 20% by volume



Each pad is molded with its size in raised letters.

## FEATURES AND BENEFITS

- Lightweight, yet rugged
- Drillable for securing unit
- Uniform ribbing transfers load evenly
- Unaffected by UV or weather
- Subtle texture resists unit slide



The bottom of a 2" E Lite® pad shows extensive ribbing.

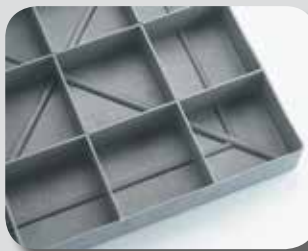

The bottom of a 3" E Lite® pad shows ribbing plus additional surface support.



E Lite® plastic equipment pads are manufactured at DiversiTech's Conyers, Georgia plant.

# Hef-T-Pad™ Equipment Pads

*Hef-T-Pad™ is an injection molded equipment pad created from high impact polypropylene with UV inhibitors making it easy to handle, yet durable and strong. It does not require any additional equipment for moving and handling. Hef-T-Pad™ is resistant to impact, ultraviolet degradation and weathering and will not crack, flake, or warp. It is virtually impervious to climatic variations. Hef-T-Pad™ is drillable to permit installation of refrigerant and electrical lines under and through the pad and to allow equipment to be easily secured to the pad.*



## FEATURES AND BENEFITS OF THE HEF-T-PAD™

Stabilization foot increases the surface area for bearing stabilization on soil; reduces sinking in soft soil under heavy load. Support ribs provide structural support.



Stabilization flange provides a wide perimeter that reduces sinking in soft soil under heavy load. Both the flange and ribbing provide reinforcement for the corners.



The thick walled polymer is suitable for drilling and screw fastening of equipment, line sets, and electrical connections.



Attractive neutral gray color with pad size and branding clearly embossed on pad surface.



Textured surface provides good aesthetics and a non-skid surface.



Pad size is molded into the side of the pad as well as the top surface.



# The Black Pad® replaces Concrete Equipment Bases

## Eco-friendly

**A**n innovative equipment base, The Black Pad® uses ground, recycled rubber in a co-injection process. The pad is extremely durable, resistant to ultraviolet light, and heavier than a completely plastic pad. The Black Pad® is ideal for pool and spa pumps, filters and heaters. The Black Pad® is extremely weather resistant and easy to drill and secure pool and spa equipment.





- No cracking and less breakage than concrete
- Extremely durable, yet lightweight
- UV resistant; unaffected by weather
- Generous ribbing for optimum, self-leveling ground support
- Outer edges have rounded corners with double-thick walls
- Uniform ribbing transfers load evenly
- Textured surface prevents equipment slippage
- Drillable for securing equipment
- Made of recycled material
- ICC Certified to 1997 Standard Swimming Pool Code sections 305.2 Mounting and section 405 Equipment Foundations and Enclosures.

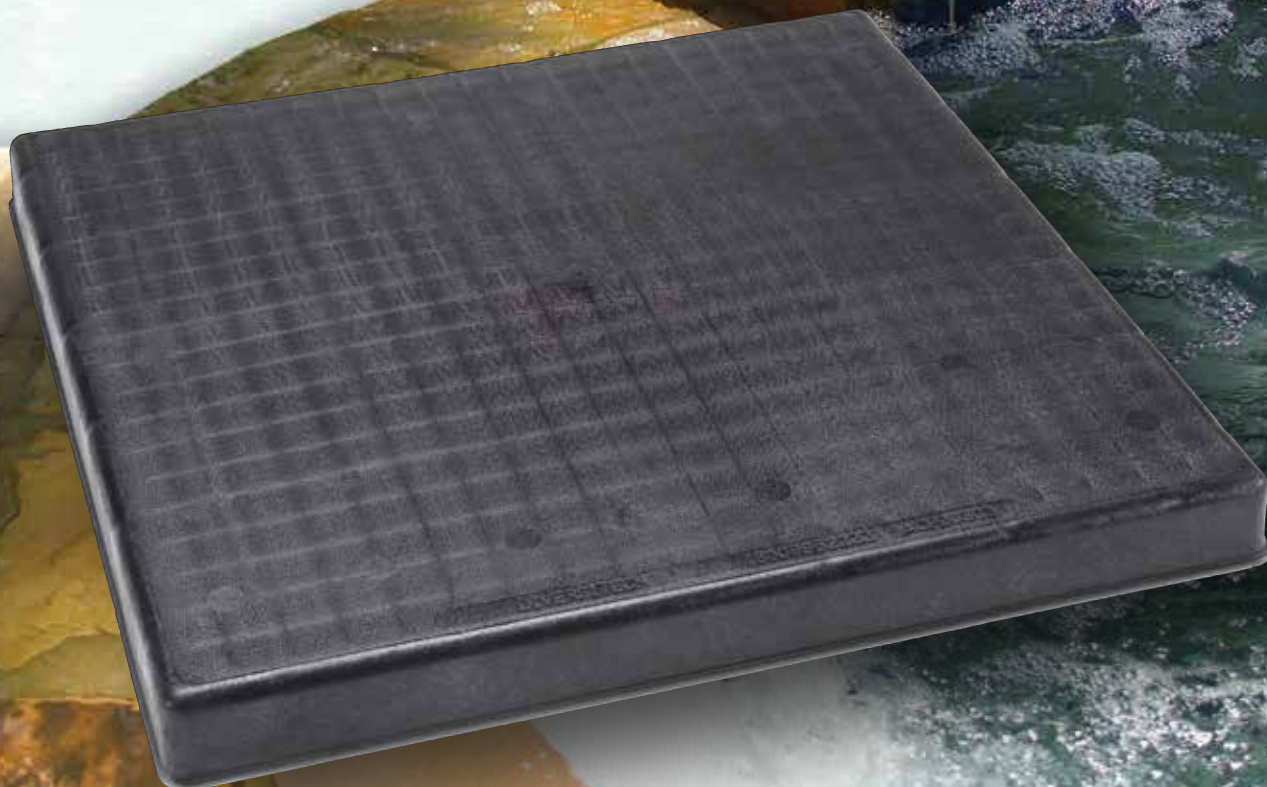
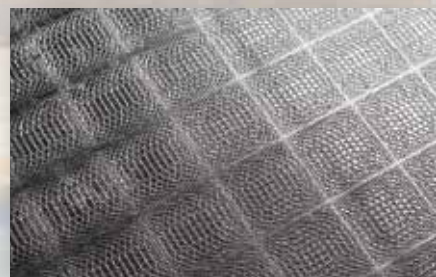

# UltraLite® Equipment Pads

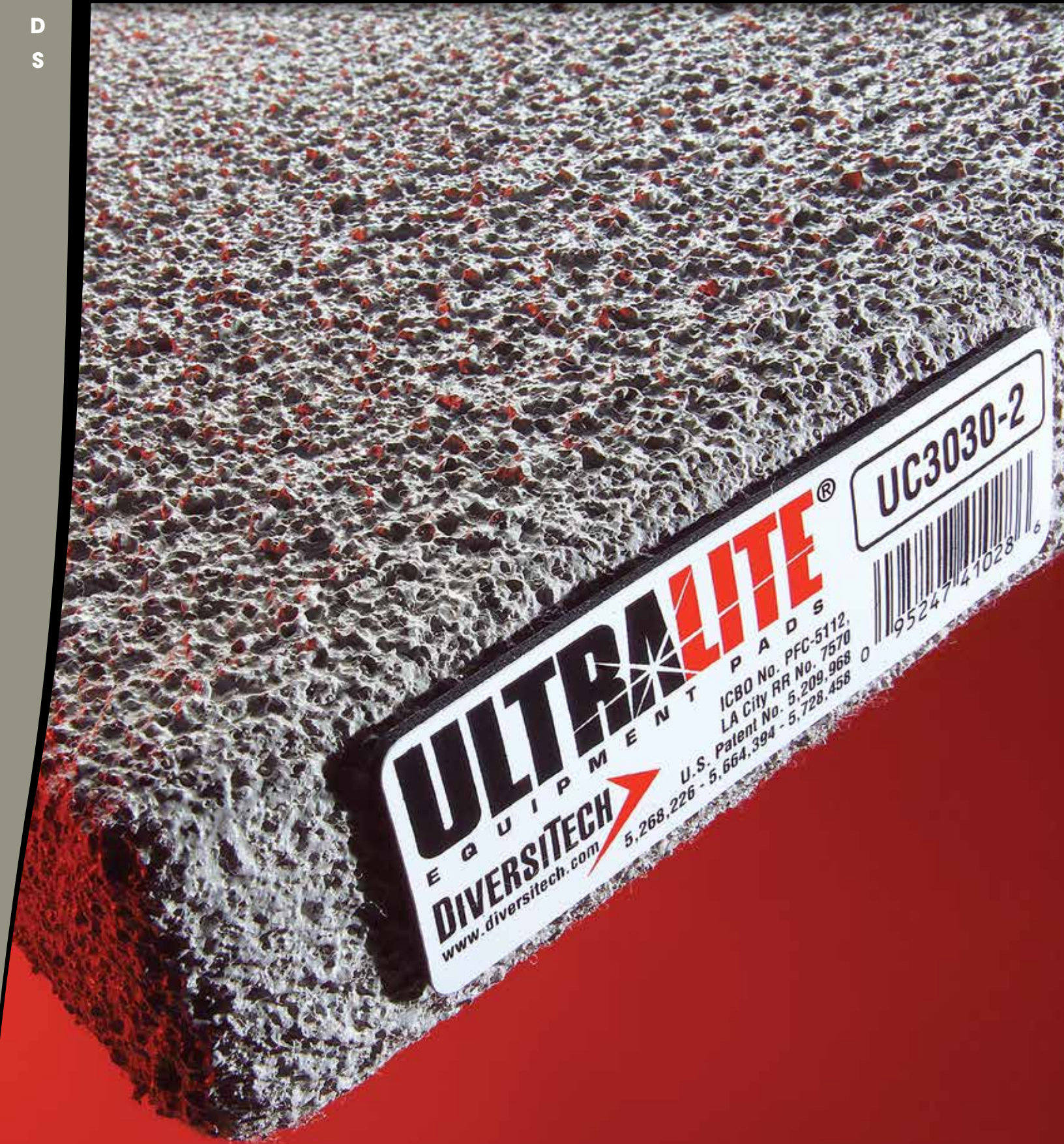

UltraLite® Pads are made by DiversiTech, North America's largest manufacturer of equipment pads.

## FEATURES AND BENEFITS

**LIGHTWEIGHT** At an average weight of 2-1/2 pounds per square foot (12 kg. per square metre), the UltraLite lightweight concrete pad is one of the lightest equipment mounting products available today. Lightweight products are important for ease of handling on job site.

**DURABLE** The exterior of the UltraLite lightweight concrete pad is specifically engineered for long-term exterior weather resistance.

**DUCTILE** The skin and core of the UltraLite lightweight concrete pad is specifically engineered for flexibility and ductility demanded of job site handling. Additionally, the ductility of the outer skin facilitates conformance to slight ground contours without fracture.

**TIME/LABOR SAVINGS** Time is money, and hence any time savings on site translates into money saved. The UltraLite lightweight concrete pad literally installs in seconds while providing a solid foundation for the condensing unit.

**CONCRETE SURFACE** The concrete external skin of the UltraLite lightweight concrete pad is not subject to ultraviolet degradation or weathering discoloration.

**VIBRATION ABSORBING** The engineered polystyrene core in the UltraLite lightweight concrete pad absorbs and dampens vibration associated with normal operation of a condensing unit.

**FREEZE/THAW RESISTANT** The UltraLite lightweight concrete pad is vapor permeable. Water vapor evaporates through the pad, hence the concrete outer skin is not subject to expansion cracks.

**FLAME RESISTANT** The concrete outer skin of the UltraLite lightweight concrete pad is resistant to heating caused by the compressor. Additionally, the surface is resistant to heat from incidental torch flame during site installation.

**OUTSIDE STORAGE** The UltraLite lightweight concrete pad is intended for life in the outdoors. As such, the pad is suitable for exterior storage prior to site installation.

## TECHNICAL DATA

### LOADING

To achieve the maximum permissible pad load capacity, the earth under the pad must be capable of supporting the transmitted compression load of the UltraLite pad. All values tabulated assume the earth has a bearing capacity of at least 1000 pounds per square foot (48 kPa).

The allowable loads assume a uniformly distributed loading on the pad surface (that is, a relatively flat-bottomed condenser unit in contact with the pad). For condenser units with footpads or other point loads, the maximum concentrated load for any size UltraLite pad is 125 pounds per 2" (56 kg per 50 mm) diameter (or equivalent surface area) footpad.

### CHEMICAL RESISTANCE

In normal usage conditions an equipment pad can be exposed to a variety of chemicals. The UltraLite pad has been fully tested in accordance with ASTM D2299 for resistance against:

- R-22 and R-134a
- Compressor oil
- Salt solution, 20 percent by volume
- Synthetic canine urine

The UltraLite pad performs extraordinarily well under these testing criteria. UltraLite does not craze, soften, delaminate, or spall under exposure in this test.

### FREEZE/THAW TESTING

The UltraLite pad has been independently tested to the rigorous freeze-thaw regimen specified by ASTM C67. This standard dictates a twenty-five cycle freeze-thaw sequence. The freeze portion of the sequence takes place with the top surface of the UltraLite pad under 1/2" (12 mm) of water. Once twenty-five cycles are complete, the pad is examined using visual magnification. No cracks or crazing is permitted. UltraLite has performed flawlessly.



# CladLite® Equipment Pads



***Tough. Durable. Strong.***

CladLite® Equipment Pads provide the strength and durability customers demand in an easy to install pad. CladLite® Pads are up to 80% lighter than solid concrete but still provide rock solid support for equipment. Once it's set, so are you. CladLite® Pads stay in place and can withstand anything mother nature can throw at them. These pads provide superior resistance to sun, moisture, and freeze-thaw conditions. And the vibration dampening EPS foam core is unaffected by water, soil, fungus or bacteria. Cladlite® Pads are available in 2" and 3" thickness and more than 70 different sizes so you can get the exact pad you need for the job. Get the concrete pads that homeowners prefer – Cladlite®.

## CLADLITE® SPECIFICATIONS

Allowable Load: 125 lbs. per 2" diameter foot

Freeze/Thaw: Flawless performance under the 25-cycle regimen specified by ASTM C67

Chemical Resistance: Does not craze, soften, delaminate, or spall when tested per ASTM D2299 with the following:

- R-22 and R-134a
- Compressor oil
- Synthetic canine urine
- Salt solution, 20% by volume

Foam Core: ASTM Type 1 EPS

Flame Resistance:

Cladding resists compressor heat and incidental torch contact.

Not to be used under heating devices.



# Heat Pump Pad™



*Ideal for snowy climates, the new DiversiTech Heat Pump Pad™ is the perfect solution for protecting equipment and ensuring proper operation year round. The Heat Pump Pad™ provides a full 8"*

*clearance from ground level in a compact 36" square footprint. Included with every Heat Pump Pad™ are 8 anti-vibration pads, specifically molded into slots in the pad to reduce vibration and provide quiet operation of your equipment. The base of the pad is also angled to direct melting snow or condensate away from the unit and pad. Heat Pump Pads are made from recycled polypropylene so they are eco-friendly and are built tough to provide many years of service. These pads also nest together for easier transportation and warehousing.*

Each Heat Pump Pad™ includes eight Anti-Vibration pads fitted into special slots in the risers to reduce equipment vibration and noise.

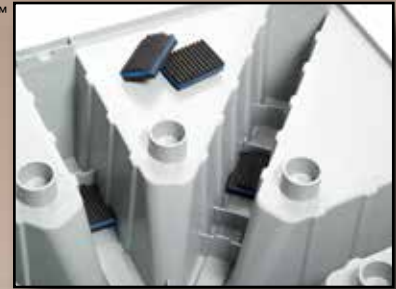

**Stackable!**

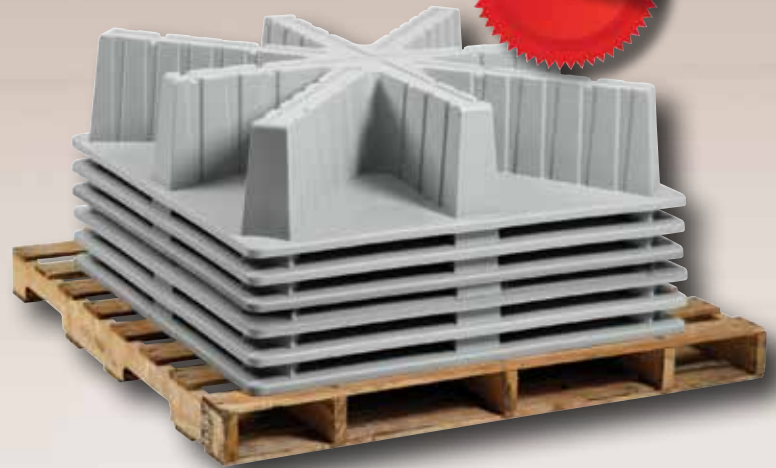



# The Hurricane Pad™

## THE HURRICANE PAD™ CONCRETE EQUIPMENT PAD

**Hurricane strength equipment pads designed to Florida's tough standards.**

DiversiTech's family of Hurricane Pads provide complete protection when the weather turns the worst. Three different models and dozens of sizes of The Hurricane Pad ensure you have the right pad for any area or need. Each DiversiTech Hurricane Pad includes these features:

- Steel reinforced
- 3,000 psi minimum concrete, mandatory to meet strict anchor pullout requirements
- Easier to install
- Will not float (unlike air filled pads)
- Uses standard Tapcon™ brand screws and no inserts are necessary
- Superior screw pullout strength



### FLORIDA BUILDING CODE NOTICE

This product meets the following Florida Building Code requirements:

1. Florida Building Commission (DCA02-DEC-183) declares this pad to be an acceptable alternative material to solid concrete pads.
2. This pad meets Mechanical Volume, Section 304.10 – clearance from grade.
3. Pad weight and wind load requirements have been calculated by Master Consulting Engineers. For up to date calculations and documentation, visit our website: [www.diversitech.com](http://www.diversitech.com).



## THE HURRICANE PAD™

The Hurricane Pad is designed for installations up to 150 MPH. The Hurricane Pad provides a solid base for mounting and protecting equipment threatened by adverse conditions.



## THE HURRICANE PAD™ T CLASS

The Hurricane Pad T-Class is designed for even higher wind loads - up to 175 MPH. Ideal for south Florida counties and other heavily threatened areas, the T Class Hurricane Pads are heavier and provide additional concrete for superior anchor pullout strength.



## THE HURRICANE PAD™ MD

The ultimate in protection, The Hurricane Pad MD is specifically designed for the strict regulations of Miami-Dade county. These solid concrete pads meet the Florida Building Code Notice and can withstand winds up to 175 MPH. This pad is made from a minimum 7000PSI solid concrete.



*Equipment must be properly attached to The Hurricane Pad™ in order to prevent sliding and tipping in high winds.*

# Anti-Vibration Pads

## EVA™ PAD: The BEST Performer

EVA™ (Extreme Vibration Attenuation) is the latest generation in vibration dampening technology. In the most severe vibration extremes, testing shows the EVA™ pad outperforms cork and rubber by greater than 3:1 and outperforms our competitor's "waffle" pad by greater than 8:1! The enhanced performance comes from the special composite foam center which is structurally more sound than cork. EVA™ is not affected by oils or chemicals that can break down cork and is much more effective at vibration dampening than solid rubber. Designed to withstand 50 psi. Choose EVA™ to get the best of both worlds!

ANTI-VIBRATION PAD PERFORMANCE

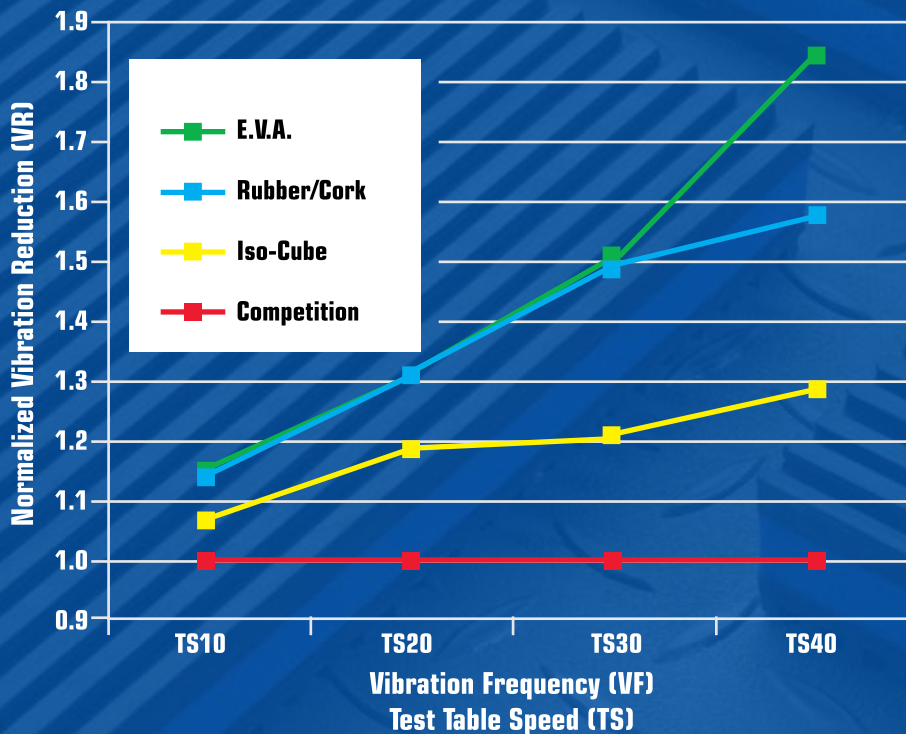

**RUBBER/CORK PAD:  
The Industry Standard**

These pads are made with the highest quality elastomeric oil resistant padding. Designed to withstand 50 psi. The rubber pads are corrugated on both sides and laminated to the cork center.

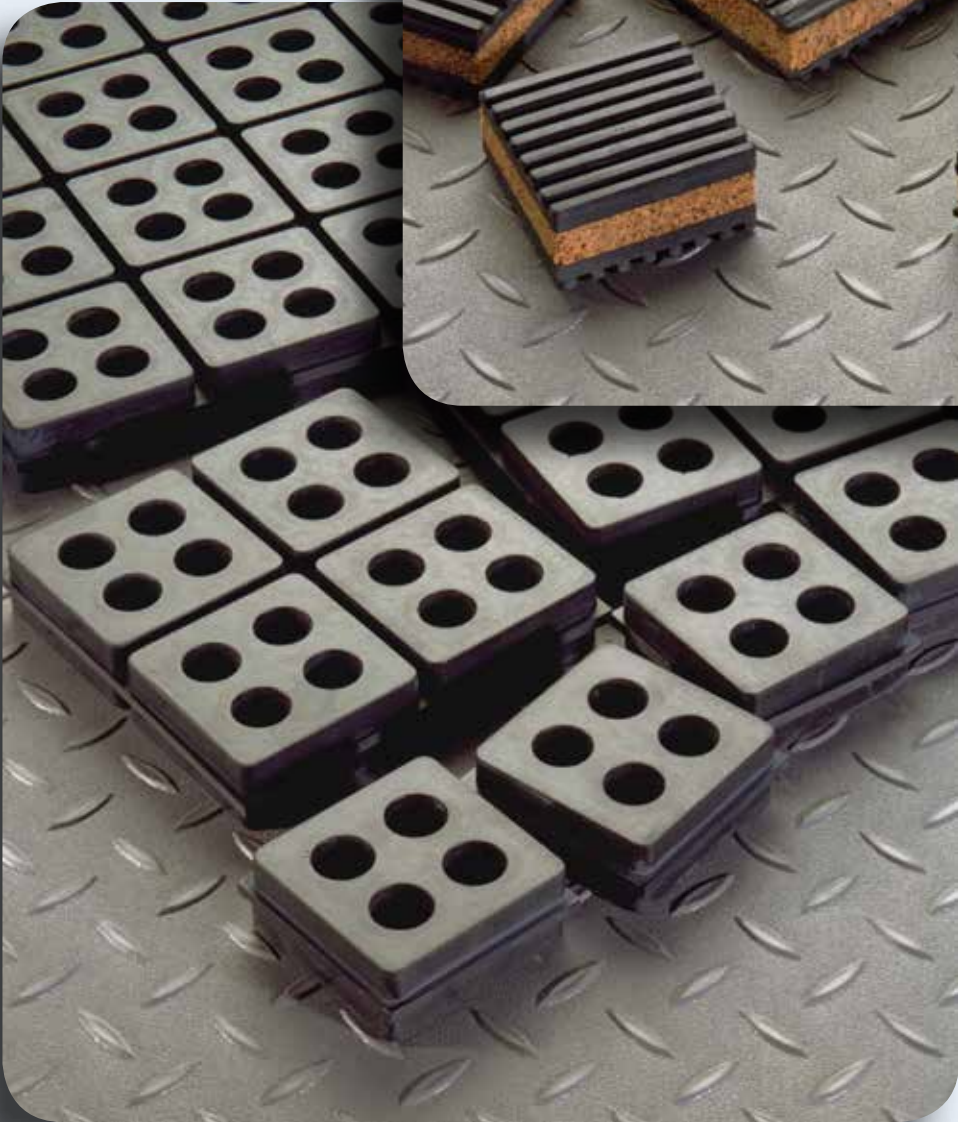
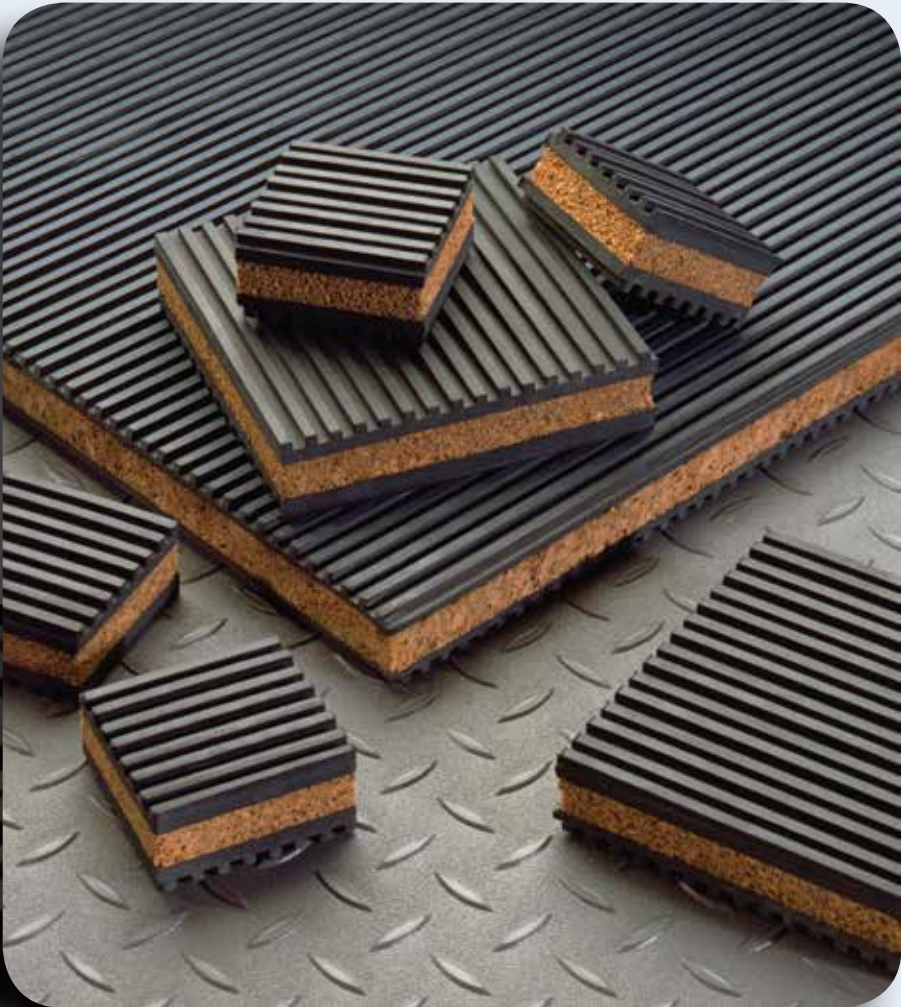

**ISO-CUBE:  
Solid Rubber Tough**

Natural rubber pads designed to reduce vibration and noise emanating from refrigeration or AC equipment. Circular design offers a suction cup effect eliminating the need to bolt the pads down. A standard 18" pad divides into eighty-one 2" segments which may be cut or torn into smaller pads. The 50 durometer pads will withstand a load of 180 psi with great resiliency.

# A/C Brackets

**DiversiTech offers a complete selection of quality air conditioning brackets for standard and mini-split condensing units.**



**AIR CONDITIONING BRACKETS**  
These heavy duty 1/8" thick steel A/C brackets are perfect for hanging A/C condensers and heat pumps outside the home.

## **HeF-T-Bracket™**



### **HEF-T-BRACKET™ TYPE 2**

These brackets feature a cross bar that is attached to a wall and two L-shaped brackets that are hooked and bolted into place on the cross bar.



When operating in heat pump mode, the unit will produce condensate which is easily captured and managed using this snap on drain pan.

**Hef-T-Block™**



**HEF-T-BLOCK™**

For use as mounting bases when condensing units must be bolted down. End caps are also available for aesthetics.



**Hef-T-Frame™**

The flexibility of the Hef-T-Frame™ equipment support system means that “designing” is simple. It is a perfect solution for mounting any type of equipment. Simply start with a Hef-T-Frame™ Base and add as many Hef-T-Frame™ Extenders as needed to create your own system.

See pages 194-195 for more information on the Hef-T-Frame™ equipment support system.



**ULTRALITE® LIGHTWEIGHT CONCRETE EQUIPMENT PADS**

A true concrete equipment pad at the weight of plastic (about 2.5 lbs. per square foot). UltraLite® is strengthened by miles of fiber in each square foot of fiber-cement coating. This fiber allows the pad to flex instead of cracking or breaking. The textured surface prevents the condensing unit or portable generator from sliding, and allows water drainage, while the engineered encapsulated polystyrene (EPS) core prevents warping and provides a solid bottom to resist settling. Unaffected by soil conditions, ultraviolet (UV) light, temperature extremes, and other weather conditions.



UC2424-2

**2" UltraLite® Pads**

The 2" thick UltraLite® pad is the industry standard. Used across a wide variety of applications, unless a thicker pad (3") is required by the local building code.

CATALOG NO.	SIZE	PAD WT.	PALLET QTY.	PALLET WT.	UOM	ORDER MULTIPLE
UC1636-2	16 X 36	11	20	250	EA	20
UC2424-2	24 X 24	15	20	323	EA	20
UC2430-2	24 X 30	17	20	361	EA	20
UC2436-2	24 X 36	22	20	455	EA	20
UC2448-2	24 X 48	18	20	385	EA	20
UC2626-2	26 X 26	17	20	365	EA	20
UC2628-2	26 X 28	19	20	397	EA	20
UC3030-2	30 X 30	21	20	441	EA	20
UC3036-2	30 X 36	27	20	571	EA	20
UC3040-2	30 X 40	30	20	617	EA	20
UC3143-2	31 X 43	26	20	551	EA	20
UC3232-2	32 X 32	24	20	501	EA	20
UC3234-2	32 X 34	23	20	485	EA	20
UC3237-2	32 X 37	28	20	579	EA	20
UC3434-2	34 X 34	23	20	493	EA	20
UC3445-2	34 X 45	45	20	915	EA	20
UC3636-2	36 X 36	27	20	555	EA	20
UC3640-2	36 X 40	29	20	608	EA	20
UC3648-2	36 X 48	35	20	725	EA	20
UC3842-2	38 X 42	30	20	625	EA	20
UC4040-2	40 X 40	32	20	644	EA	20
UC4147-2	41 X 47	39	20	805	EA	20

U.S. Patents 7,334,385; 7,232,589; 6,931,822; 6,927,183; 5,728,458; 5,664,394; 5,268,226; 5,209,968, and patents pending. ICBO PFC-5112.

**3" UltraLite® Pads**

Where local codes supersede the International code and require a pad thicker than 2" — 3" UltraLite® is the solution.



UC2424-3

CATALOG NO.	SIZE	PAD WT.	PALLET QTY.	PALLET WT.	UOM	ORDER MULTIPLE
UC1636-3	16 X 36	18	15	297	EA	15
UC1838-3	18 X 38	18	15	297	EA	15
UC2424-3	24 X 24	18	15	294	EA	15
UC2430-3	24 X 30	21	15	339	EA	15
UC2436-3	24 X 36	26	15	412	EA	15
UC2442-3	24 X 42	28	15	441	EA	15
UC2448-3	24 X 48	28	15	443	EA	15
UC2626-3	26 X 26	17	15	279	EA	15
UC2636-3	26 X 36	29	15	428	EA	15
U2660-3	26 X 60	55	15	850	EA	15
UC2838-3	28 X 38	30	15	471	EA	15
UC3030-3	30 X 30	23	15	370	EA	15
UC3036-3	30 X 36	30	15	471	EA	15
UC3040-3	30 X 40	33	15	517	EA	15
UC3048-3	30 X 48	40	15	625	EA	15
U3060-3	30 X 60	63	15	970	EA	15
UC3232-3	32 X 32	26	15	411	EA	15
UC3237-3	32 X 37	27	15	436	EA	15
U3353-3	33 X 53	68	15	1,045	EA	15
UC3434-3	34 X 34	27	15	427	EA	15
UC3445-3	34 X 45	39	15	612	EA	15
U3465-3	34 X 65	71	15	1,090	EA	15
UC3636-3	36 X 36	34	15	528	EA	15
UC3642-3	36 X 42	32	15	510	EA	15
UC3648-3	36 X 48	37	15	579	EA	15
U3650-3	36 X 50	38	15	595	EA	15
U3654-3	36 X 54	71	15	1,096	EA	15
U3660-3	36 X 60	49	15	767	EA	15
U3678-3	36 X 78	99	15	1,510	EA	15
UC3842-3	38 X 42	35	15	550	EA	15
U3865-3	38 X 65	85	15	1,300	EA	15
U3870-3	38 X 70	113	15	1,720	EA	15
UC4040-3	40 X 40	34	15	510	EA	15
UC4042-3	40 X 42	36	15	565	EA	15
U4054-3	40 X 54	81	15	1,240	EA	15
UC4347-3	43 X 47	60	15	925	EA	15
U4550-3	45 X 50	81	15	1,240	EA	15
U4558-3	45 X 58	93	15	1,420	EA	15
U4848-3	48 X 48	85	15	1,300	EA	15
U4854-3	48 X 54	91	15	1,390	EA	15
U4866-3	48 X 66	108	15	1,645	EA	15
U5053-3	50 X 53	92	15	1,405	EA	15
U5056-3	50 X 56	97	15	1,480	EA	15
U5075-3	50 X 75	130	15	1,975	EA	15
U5079-3	50 X 79	145	15	2,200	EA	15
U5252-3	52 X 52	94	15	1,435	EA	15
U5260-3	52 X 60	109	15	1,660	EA	15
U5557-3	55 X 57	109	15	1,660	EA	15
U6067-3	60 X 67	134	15	2,035	EA	15

**ULTRALITE® LIGHTWEIGHT CONCRETE EQUIPMENT PADS cont'd**

**3" UltraLite® Wedge Pads**

The UltraLite® Wedge Pad is designed for Lennox condensing units.



UC3132-3L

CATALOG NO.	SIZE	PAD WT.	PALLET QTY.	PALLET WT.	UOM	ORDER MULTIPLE
<b>UC3132-3L</b>	31 X 32	23.33	15	350	EA	15
<b>UC3539-3L</b>	35 X 39	33.46	15	502	EA	15
<b>UC4044-3L</b>	40 X 44	37.53	15	563	EA	15

**UltraLite® Earthquake Code Compliant Pads**

Required nearly exclusively in Southern California, the UltraLite® pad is available for compliance with strict attachment provisions detailed in earthquake prone local building codes. UltraLite® earthquake code compliant pads are only available for sale in regions where local codes mandate installation of pads with these particular characteristics. Currently these locales include most of Southern California, portions of Washington, and portions of Oregon.



UC2424-3CA

CATALOG NO.	SIZE	PAD WT.	PALLET QTY.	PALLET WT.	UOM	ORDER MULTIPLE
<b>UC1838-3CA</b>	18 X 38	18	15	273	EA	15
<b>UC2424-3CA</b>	24 X 24	14	15	241	EA	15
<b>UC2436-3CA</b>	24 X 36	22	15	349	EA	15
<b>UC2448-3CA</b>	24 X 48*	28	15	443	EA	15
<b>UC2636-3CA</b>	26 X 36	29	15	428	EA	15
<b>UC3030-3CA</b>	30 X 30	22	15	351	EA	15
<b>UC3036-3CA</b>	30 X 36	25	15	400	EA	15
<b>UC3040-3CA</b>	30 X 40	34	15	510	EA	15
<b>UC3232-3CA</b>	32 X 32	24	15	381	EA	15
<b>UC3445-3CA</b>	34 X 45	33	15	516	EA	15
<b>UC3636-3CA</b>	36 X 36	28	15	441	EA	15
<b>UC3642-3CA</b>	36 X 42	32	15	510	EA	15
<b>UC3648-3CA</b>	36 X 48	37	15	579	EA	15
<b>UC4040-3CA</b>	40 X 40	34	15	510	EA	15

**E LITE® PLASTIC EQUIPMENT PADS**

E Lite's rugged design provides uniform and generous ribbing for optimum, self-leveling ground support without inserts. The result is a pad that is lightweight, but not too light. A subtle texture prevents unit slide and presents a classic appearance, which is enhanced by rounded edges and a concrete gray color. Each pad is molded with a size label and a symbol representing content of recycled material.



EL2424-2

**3" E Lite® Pads**

Used where local codes supersede the International code and require a pad thicker than 2".



EL5658-3

**2" E Lite® Pads**

The 2" thick E Lite® pad is the choice for plastic pads, unless a thicker pad (3") is required by the local building code.

CATALOG NO.	SIZE	PAD WT.	PALLET QTY.	PALLET WT.	UOM	ORDER MULTIPLE
<b>EL2424-2</b>	24 X 24	7	44	333	EA	44
<b>EL2430-2</b>	24 X 30	9	22	219	EA	22
<b>EL2436-2</b>	24 X 36	11	22	256	EA	22
<b>EL2626-2</b>	26 X 26	8	22	205	EA	22
<b>EL3030-2</b>	30 X 30	11	22	265	EA	22
<b>EL3036-2</b>	30 X 36	13	22	313	EA	22
<b>EL3040-2</b>	30 X 40	15	22	346	EA	22
<b>EL3232-2</b>	32 X 32	13	22	300	EA	22
<b>EL3238-2</b>	32 X 38	15	22	351	EA	22
<b>EL3244-2</b>	32 X 44	17	22	401	EA	22
<b>EL3434-2</b>	34 X 34	14	22	350	EA	22
<b>EL3636-2</b>	36 X 36	16	22	373	EA	22
<b>EL3640-2</b>	36 X 40	18	22	410	EA	22
<b>EL3648-2</b>	36 X 48	29	22	663	EA	22
<b>EL3842-2</b>	38 X 42	19	22	470	EA	22

CATALOG NO.	SIZE	PAD WT.	PALLET QTY.	PALLET WT.	UOM	ORDER MULTIPLE
<b>EL1838-3</b>	18 X 38	16	16	300	EA	16
<b>EL2424-3</b>	24 X 24	13	16	225	EA	16
<b>EL2430-3</b>	24 X 30	16	16	277	EA	16
<b>EL2436-3</b>	24 X 36	19	16	321	EA	16
<b>EL3030-3</b>	30 X 30	20	16	345	EA	16
<b>EL3040-3</b>	30 X 40	26	16	448	EA	16
<b>EL3232-3</b>	32 X 32	21	16	353	EA	16
<b>EL3238-3</b>	32 X 38	26	16	448	EA	16
<b>EL3244-3</b>	32 X 44	30	16	499	EA	16
<b>EL3636-3</b>	36 X 36	28	16	471	EA	16
<b>EL3640-3</b>	36 X 40	31	16	521	EA	16
<b>EL3648-3</b>	36 X 48	36	16	601	EA	16
<b>EL3842-3</b>	38 X 42	33	16	575	EA	16
<b>EL3870-3</b>	38 X 70	36	16	604	EA	16
<b>EL4040-3</b>	40 X 40	31	16	546	EA	16
<b>EL4558-3</b>	45 X 58	33	16	545	EA	16
<b>EL4848-3</b>	48 X 48	29	16	481	EA	16
<b>EL4872-3</b>	48 X 72	72	16	1,177	EA	16
<b>EL5252-3</b>	52 X 52	48	16	793	EA	16
<b>EL5658-3</b>	56 X 58	43	16	715	EA	16

**CLADLITE® LIGHTWEIGHT CONCRETE EQUIPMENT PADS**

Concrete surface and superior performance at 20% the weight of conventional concrete pads. The cladding provides superior resistance to sun, moisture and freeze-thaw conditions; the engineered encapsulated polystyrene (EPS) core is virtually impervious to water, soil conditions, fungus and bacteria. CladLite® is further strengthened by continuous steel reinforcement throughout the cladding. CladLite® is code approved for installation throughout the U.S.

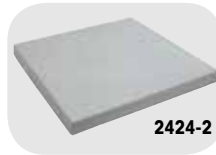

2424-2

**3" CladLite® Pads**

Used where local codes supersede the International code and require a pad thicker than 2".

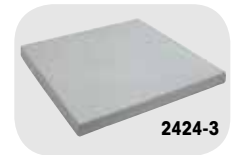

2424-3

**2" CladLite® Pads**

The 2" thick CladLite® pad is the choice for equipment pads, unless a thicker pad (3") is required by the local building code.

CATALOG NO.	SIZE	PAD WT.	PALLET QTY.	PALLET WT.	UOM	ORDER MULTIPLE
1636-2	16 X 36	33	25	850	EA	25
2424-2	24 X 24	36	25	913	EA	25
2430-2	24 X 30	37	25	950	EA	25
2436-2	24 X 36	50	25	1,275	EA	25
2442-2	24 X 42	57	25	1,450	EA	25
2448-2	24 X 48	72	25	1,825	EA	25
2454-2	24 X 54	84	25	2,125	EA	25
26-2	26 Round	31	25	800	EA	25
2626-2	26 X 26	38	25	975	EA	25
2636-2	26 X 36	54	25	1,375	EA	25
2660-2	26 X 60	95	25	2,400	EA	25
2838-2	28 X 38	55	25	1,400	EA	25
30-2	30 Round	36	25	925	EA	25
3030-2	30 X 30	48	25	1,225	EA	25
3036-2	30 X 36	60	25	1,525	EA	25
3040-2	30 X 40	70	25	1,775	EA	25
3060-2	30 X 60	112	25	2,825	EA	25
3143-2	31 X 43	83	25	2,100	EA	25
32-2	32 Round	44	25	1,125	EA	25
3232-2	32 X 32	54	25	1,375	EA	25
3237-2	32 X 37	66	25	1,675	EA	25
3434-2	34 X 34	63	25	1,600	EA	25
36-2	36 Round	51	25	1,300	EA	25
3636-2	36 X 36	76	25	1,925	EA	25
3640-2	36 X 40	81	25	2,050	EA	25
3648-2	36 X 48	115	25	2,900	EA	25
3654-2	36 X 54	93	25	2,350	EA	25
3842-2	38 X 42	81	25	2,100	EA	25
4147-2	41 X 47	115	25	2,900	EA	25
4848-2	48 X 48	100	25	2,525	EA	25

U.S. Patent number 4,505,449, and patents pending. ICBO No. PFC-5112.

CATALOG NO.	SIZE	PAD WT.	PALLET QTY.	PALLET WT.	UOM	ORDER MULTIPLE
1636-3	16 X 36	46	20	945	EA	20
2424-3	24 X 24	49	20	995	EA	20
2430-3	24 X 30	57	20	1,165	EA	20
2436-3	24 X 36	63	20	1,285	EA	20
2448-3	24 X 48	71	20	1,445	EA	20
2460-3	24 X 60	105	20	2,125	EA	20
2626-3	26 X 26	53	20	1,085	EA	20
2660-3	26 X 60	109	20	2,205	EA	20
2838-3	28 X 38	84	20	1,705	EA	20
3030-3	30 X 30	62	20	1,265	EA	20
3036-3	30 X 36	71	20	1,445	EA	20
3040-3	30 X 40	94	20	1,905	EA	20
3060-3	30 X 60	130	15	1,975	EA	15
3143-3	31 X 43	74	20	1,505	EA	20
32-3	32 Round	67	20	1,365	EA	20
3232-3	32 X 32	68	20	1,385	EA	20
3237-3	32 X 37	87	20	1,765	EA	20
3345-3	33 X 45	117	20	2,365	EA	20
3434-3	34 X 34	86	20	1,770	EA	20
3465-3	34 X 65	160	15	2,425	EA	15
36-3	36 Round	80	20	1,625	EA	20
3636-3	36 X 36	100	20	2,025	EA	20
3640-3	36 X 40	120	20	2,425	EA	20
3648-3	36 X 48	132	20	2,665	EA	20
3650-3	36 X 50	137	15	2,080	EA	15
3660-3	36 X 60	163	15	2,470	EA	15
3678-3	36 X 78	196	10	1,985	EA	10
3842-3	38 X 42	132	20	2,700	EA	20
3865-3	38 X 65	179	15	2,710	EA	15
3870-3	38 X 70	179	10	1,815	EA	10
4042-3	40 X 42	170	10	1,700	EA	10
4054-3	40 X 54	167	15	2,530	EA	15
4062-3	40 X 62	179	10	1,815	EA	10
4147-3	41 X 47	140	15	2,125	EA	15
4183-3	41 X 83	231	10	2,335	EA	10
4550-3	45 X 50	158	15	2,395	EA	15
4558-3	45 X 58	177	15	2,680	EA	15
4766-3	47 X 66	219	10	2,215	EA	10
4848-3	48 X 48	150	15	2,275	EA	15
5053-3	50 X 53	194	15	2,935	EA	15
5056-3	50 X 56	212	10	2,145	EA	10
5058-3	50 X 58	212	10	2,145	EA	10
5070-3	50 X 70	257	10	2,595	EA	10
5252-3	52 X 52	197	10	1,995	EA	10
5557-3	55 X 57	237	10	2,395	EA	10
6067-3	60 X 67	284	10	2,865	EA	10



**THE HURRICANE PAD™ CONCRETE EQUIPMENT PADS**

**The Hurricane Pad™**

Designed specifically for the hurricane prone regions of Florida and the Gulf Coast, The Hurricane Pad™ meets stringent local code requirements for wind resistance. Heavier than a normal concrete pad, this 4" pad provides sufficient weight to meet code. For certain taller equipment, The Hurricane T Class Pad™ is needed. Due to their extra weight, standard freight terms only apply for shipments to Florida. All other shipments are shipped FOB Conyers, GA.



**H2424-4**

**The Hurricane T-Class Pad™**

The Hurricane T Class Pad™ is even heavier than The Hurricane Pad™ and is designed to meet the higher wind loads of taller equipment. The taller the piece of equipment mounted to the pad, the greater the wind load on the pad. These heavier 4" pads provide sufficient weight to meet code for these taller condensing units. Due to their extra weight, standard freight terms for The Hurricane T Class Pad™ only apply for shipments to Florida. All other shipments are shipped FOB Conyers, GA.



**HT2424-4**

CATALOG NO.	SIZE	PALLET QTY.	UOM	ORDER MULTIPLE
H1840-4	18 X 40	16	EA	16
H2424-4	24 X 24	16	EA	16
H2436-4	24 X 36	16	EA	16
H3030-4	30 X 30	16	EA	16
H3060-4	30 X 60	16	EA	16
H3232-4	32 X 32	16	EA	16
H3345-4	33 X 45	16	EA	16
H3434-4	34 X 34	16	EA	16
H3636-4	36 X 36	16	EA	16
H3642-4	36 X 42	16	EA	16
H3648-4	36 X 48	16	EA	16
H3652-4	36 X 52	8	EA	8
H3672-4	36 X 72	8	EA	8
H3842-4	38 X 42	16	EA	16
H3852-4	38 X 52	8	EA	8
H3865-4	38 X 65	8	EA	8
H4040-4	40 X 40	8	EA	8
H4242-4	42 X 42	8	EA	8
H4558-4	45 X 58	8	EA	8
H5557-4	55 X 57	8	EA	8

CATALOG NO.	SIZE	PALLET QTY.	UOM	ORDER MULTIPLE
HT1840-4	18 X 24	10	EA	10
HT2424-4	24 X 24	5	EA	5
HT2436-4	24 X 36	5	EA	5
HT3030-4	30 X 30	5	EA	5
HT3232-4	32 X 32	5	EA	5
HT3345-4	33 X 45	5	EA	5
HT3636-4	36 X 36	5	EA	5
HT3648-4	36 X 48	5	EA	5
HT3842-4	38 X 42	5	EA	5
HT3852-4	38 X 52	5	EA	5
HT4040-4	40 X 40	5	EA	5
HT4242-4	42 X 42	5	EA	5
HT4558-4	45 X 58	5	EA	5

**The Hurricane Pad™ MD**

The new Hurricane Pad™ MD is the newest in concrete pad technology from DiversiTech. The Hurricane Pad MD is a solid concrete pad designed for the strict requirements of Miami Dade county. The Hurricane Pad MD meets the Florida Building Code Notice and can withstand winds up to 175 MPH. This pad is made from a minimum 7000PSI solid concrete.



**HMD3030-4**

CATALOG NO.	SIZE	PALLET QTY.	UOM	ORDER MULTIPLE
HMD1844-4	18x40x4	5	EA	5
HMD2436-4	24x36x4	5	EA	5
HMD3030-4	30x30x4	5	EA	5
HMD3636-4	36x36x4	5	EA	5
HMD3642-4	36x42x4	5	EA	5
HMD3648-4	36x48x4	5	EA	5
HMD4040-4	40x40x4	5	EA	5

**The Hurricane Pad Attachment Bracket**

Bracket secures condenser to The Hurricane Pad. Use #8 self drilling or self tapping screws to secure condenser to brackets. Be sure to place brackets according to local building code requirements. Made of 12 gauge ASTM A653 Grade 40 steel with G90 coating.

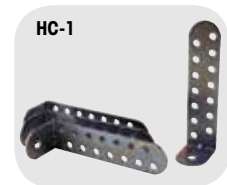

**HC-1**

CATALOG NO.	DESCRIPTION	UOM	ORDER MULTIPLE
HC-1	The Hurricane Pad Attachment Bracket, pack of 4 PK	PK	1
HC- 1-100	The Hurricane Pad Attachment Bracket, pack of 100 PK	PK	1

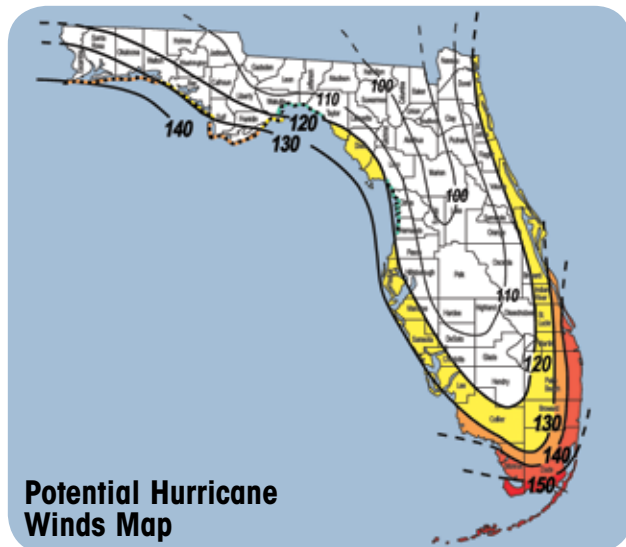

## THE BLACK PAD® BLACK PLASTIC EQUIPMENT PADS

The Black Pad® is an innovative equipment pad using ground, recycled rubber in a co-injection process. The pad is extremely durable, resistant to ultraviolet light, and heavier than a completely plastic pad. The Black Pad® is suitable for use with pool pumps, filters, and heaters and complies with the 1997 Standard Swimming Pool Code sections 305.2 Mounting and section 405 Equipment Foundations and Enclosures.



ACP24242

### The Black Pad® — 3"

Used where local codes supersede the International code and require a pad thicker than 2".



ACP24243

### The Black Pad® — 2"

The 2" thick Black Pad® is the choice for plastic pads, unless a thicker pad (3") is required by the local building code.

CATALOG NO.	SIZE	PAD WT.	PALLET QTY.	PALLET WT.	UOM	ORDER MULTIPLE
ACP24242	24 X 24	10	24	240	EA	24
ACP24362	24 X 36	15	24	360	EA	24
ACP30302	30 X 30	13	24	312	EA	24
ACP32322	32 X 32	16	24	384	EA	24
ACP32442	32 X 44	23	24	552	EA	24
ACP36362	36 X 36	19	24	456	EA	24
ACP38422	38 X 42	25	24	600	EA	24

CATALOG NO.	SIZE	PAD WT.	PALLET QTY.	PALLET WT.	UOM	ORDER MULTIPLE
ACP24243	24 X 24	12	16	192	EA	16
ACP30303	30 X 30	20	16	320	EA	16
ACP32323	32 X 32	25	16	400	EA	16
ACP36363	36 X 36	23	16	368	EA	16
ACP36483	36 X 48	37	16	592	EA	16

## HEF-T-PAD™ PLASTIC EQUIPMENT PADS

Hef-T-Pad™ is an injection molded equipment pad created from high impact polypropylene with UV inhibitors making it easy to handle, yet durable and strong. It does not require any additional equipment for moving and handling. It is resistant to impact, ultra violet degradation and weathering and will not crack, flake, or warp. The Hef-T-Pad™ is virtually impervious to climatic variations. It is drillable to permit installation of refrigerant and electrical lines under and through the pad and to allow equipment to be easily secured to the pad.

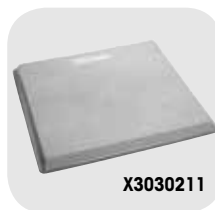

X3030211

### Hef-T-Pad™ — 3"

Used where local codes supersede the International code and require a pad thicker than 2".

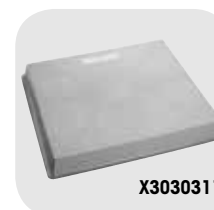

X3030311

### Hef-T-Pad™ — 2"

The 2" thick Hef-T-Pad™ is the choice for plastic pads, unless a thicker pad (3") is required by the local building code.

CATALOG NO.	SIZE	PAD WT.	PALLET QTY.	PALLET WT.	UOM	ORDER MULTIPLE
X2424211	24 X 24 X 2	6	24	208	EA	24
X2430211	24 X 30 X 2	8	24	251	EA	24
X2436211	24 X 36 X 2	10	24	290	EA	24
X3030211	30 X 30 X 2	10	24	290	EA	24
X3232211	32 X 32 X 2	11	24	312	EA	24
X3244211	32 X 44 X 2	14	24	382	EA	24
X3636211	36 X 36 X 2	13	24	367	EA	24
X3830211	38 X 30 X 2	14	24	378	EA	24
X3836211	38 X 36 X 2	14	24	376	EA	24
X3842211	38 X 42 X 2	17	24	464	EA	24

CATALOG NO.	SIZE	PAD WT.	PALLET QTY.	PALLET WT.	UOM	ORDER MULTIPLE
X2424311	24 X 24 X 3	9	16	200	EA	16
X2436311	24 X 36 X 3	12	16	242	EA	16
X3030311	30 X 30 X 3	13	16	264	EA	16
X3232311	32 X 32 X 3	16	EA	300	EA	16
X3636311	36 X 36 X 3	17	EA	319	EA	16
X3848311	38 X 48 X 3	24	EA	428	EA	16
X5055301	50 X 55 X 3	42	EA	724	EA	16

**ENVIROPAD™ BLACK PLASTIC EQUIPMENT PADS**

An injection molded equipment pad created from 100% recycled materials to minimize environmental impact. It does not require any additional equipment for moving and handling. EnviroPad™ is resistant to impact, ultra-violet degradation and weathering (virtually impervious to climatic variations), and will not crack, flake, or warp. Drillable to permit installation of refrigerant and electrical lines under and through the pad and to allow equipment to easily secure to the pad.



**EnviroPad™ — 3"**

Used where local codes supersede the International code and require a pad thicker than 2".



**EnviroPad™ — 2"**

The 2" thick EnviroPad™ is the choice for plastic pads, unless a thicker pad (3") is required by the local building code.

CATALOG NO.	SIZE	PAD WT.	PALLET QTY.	PALLET WT.	UOM	ORDER MULTIPLE
<b>EP2424-2</b>	24 X 24 X 2	6	24	208	EA	24
<b>EP3030-2</b>	30 X 30 X 2	10	24	290	EA	24
<b>EP3232-2</b>	32 X 32 X 2	11	24	312	EA	24
<b>EP3244-2</b>	32 X 44 X 2	14	24	382	EA	24
<b>EP3636-2</b>	36 X 36 X 2	13	24	367	EA	24
<b>EP3842-2</b>	38 X 42 X 2	17	24	450	EA	24

CATALOG NO.	SIZE	PAD WT.	PALLET QTY.	PALLET WT.	UOM	ORDER MULTIPLE
<b>EP1838-3</b>	18 X 38 X 3	10	16	166	EA	16
<b>EP2424-3</b>	24 X 24 X 3	9	16	200	EA	16
<b>EP3030-3</b>	30 X 30 X 3	13	16	264	EA	16
<b>EP3232-3</b>	32 X 32 X 3	16	16	300	EA	16
<b>EP3244-3</b>	32 X 44 X 3	14	16	273	EA	16
<b>EP3636-3</b>	36 X 36 X 3	17	16	319	EA	16
<b>EP3648-3</b>	36 X 48 X 3	23	16	368	EA	16
<b>EP4040-3</b>	40 X 40 X 3	28	16	496	EA	16

**HEAT PUMP PAD™**

**Heat Pump Pad™**

Provides an effective base for heat pump equipment installed in snowy climates. Rather than a combination of a typical 2" (or 3") equipment pad and 6" heat pump risers, the Heat Pump Pad™ provides a full 8" of elevation in a simple 36" x 36" footprint. The star pattern of the integral risers allows for installation of equipment with different size footprints up to 36" x 36". Also included are eight anti vibration pads uniquely designed to fit into the guide slots on the top of the integral risers. The base is sloped outward to allow for easy drainage of condensate or defrost cycle condensate when the outdoor coil is operating in heat pump mode. Nestable for efficient shipping, transportation, and warehousing. Injection molded from concrete gray, recycled polypropylene material, the Heat Pump Pad™ is environmentally friendly and designed to last longer than the equipment it supports. US Patent Number 7,891,635, and other patent(s) pending.

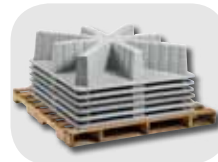

CATALOG NO.	DESCRIPTION	UOM	ORDER MULTIPLE
<b>HP3636-8</b>	36" x 36" x 8"	EA	16

## HEAT PUMP RISERS

### One Piece Heat Pump Risers

Sturdy and stable, DiversiTech's Heat Pump Riser provides the desired elevation for condensers, heat pumps, and air handlers. The one piece, heavy duty plastic unit is manufactured in three heights. Butyl mastic on the top and bottom guarantees no slipping and reduced vibration and noise.



CATALOG NO.	DESCRIPTION	UOM	ORDER MULTIPLE
<b>HPR-3</b>	Riser – 3"	EA	48
<b>HPR-6</b>	Riser – 6"	EA	36
<b>HPR-12</b>	Riser – 12"	EA	16

### Two Piece Heat Pump Risers

Sturdy and stable, DiversiTech's Heat Pump Riser provides the desired elevation for condensers, heat pumps, and air handlers. The one piece, heavy duty plastic unit is manufactured in two heights and an extension. Butyl mastic on the top and bottom guarantees no slipping and reduced vibration and noise.



CATALOG NO.	DESCRIPTION	UOM	ORDER MULTIPLE
<b>HPR-3-2P</b>	Two Piece Riser – 3"	EA	32
<b>HPR-6-2P</b>	Two Piece Riser – 6"	EA	16
<b>HPR-3-2PG</b>	Two Piece Black Riser – 3" (Charcoal)	EA	32
<b>HPR-6-2PG</b>	Two Piece Black Riser – 6" (Charcoal)	EA	16
<b>HPR-EXT</b>	4" Extension	EA	28

## MOUNTING BRACKET AND BLOCKS

### Air Handler Base – Heavy-duty Adjustable

Made of 14 gauge galvanized steel for excellent corrosion resistance and longevity. 22" high x 22" deep. Width is adjustable from 16" – 26". Supports up to 200 lbs.



CATALOG NO.	DESCRIPTION	UOM	ORDER MULTIPLE
<b>6-HAB-BG</b>	Black Steel Air Handler Base	EA	1

### Air Handler Block

Lightweight styrofoam block (concrete gray) provides A/C air handler support in attic installations.



CATALOG NO.	DESCRIPTION	UOM	ORDER MULTIPLE
<b>7-60</b>	Air Handler Block 8" x 8" x 4"	EA	144
<b>7-64</b>	Air Handler Block 8" x 8" x 4", pack of 4	PK	4

### Furnace Mounting Blocks

Each furnace mounting block can support 40% more weight than competitive products – over 500 pounds! Easy peel and stick installation.



CATALOG NO.	DESCRIPTION	UOM	ORDER MULTIPLE
<b>FB-1</b>	Furnace Mounting Block	EA	72

### Hef-T-Block™

Used as mounting bases when condensing units must be bolted down. Available in three lengths. End caps are also available for aesthetics. Furnished complete with mounting bolts. Maximum load capacity is 440 pounds per mounting block. Installation temperature range from 4F ( 20C) to 140F (60C). Hef T Blocks fit all mini split condensing units with a unique sliding rail feature.

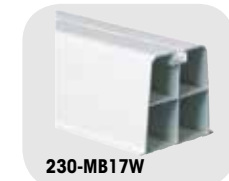

CATALOG NO.	DESCRIPTION	UOM	ORDER MULTIPLE
<b>230-MB14W</b>	14" Hef-T-Block™ (White), pack of 2	PK	6
<b>230-MB17W</b>	17" Hef-T-Block™ (White), pack of 2	PK	6
<b>230-MB36W</b>	36" Hef-T-Block™ (White), pack of 2	PK	2
<b>230-MBCW</b>	Hef-T-Block™ End Cap (White), pack of 4	PK	25

### Air Conditioner Brackets

These heavy duty 1/8" thick steel AC brackets are perfect for hanging A/C condensers and heat pumps outside the home. Mount at any height to allow for easy maintenance under units. No need to wait for finished grade or landscaping prior to installation of AC unit. Pre punched holes for easy installation. Powder coated gray finish. Load rating 600 lbs. per pair.



CATALOG NO.	DESCRIPTION	UOM	ORDER MULTIPLE
<b>ACB-30</b>	AC Mounting Bracket – 30", pack of 2	PK	1
<b>ACB-36</b>	AC Mounting Bracket – 36", pack of 2	PK	1
<b>ACB-42</b>	AC Mounting Bracket – 42", pack of 2	PK	1
<b>ACB-48</b>	AC Mounting Bracket – 48", pack of 2	PK	1

**MOUNTING BRACKET AND BLOCKS cont'd**

**Heavy Duty Bracket (Type 1)**

Heavy duty L-shaped brackets for supporting condensing units. Each 20" arm supports up to 350 lbs.

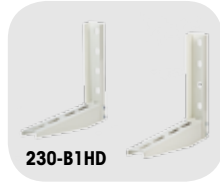

**230-B1HD**

CATALOG NO.	DESCRIPTION	ARM LENGTH	LOAD RATING PER ARM	UOM	ORDER MULTIPLE
<b>230-B1HD</b>	Heavy Duty Bracket	20"	350#	EA	1

**Hef-T-Bracket™ (Type 2) Extra Duty**

Used for supporting condensing units, Type 2 Extra Duty brackets feature a sturdy cross bar that is attached to a wall and two L shaped brackets that slide onto the crossbar and then bolt into place. The condensing unit is mounted onto the L shaped brackets and fastened using the bolts and anti-vibration washers provided. Includes bubble level and adjustable back support.



**230-B2XL**

CATALOG NO.	DESCRIPTION	ARM LENGTH	LOAD RATING PER ARM	UOM	ORDER MULTIPLE
<b>230-B2XL</b>	Hef-T-Bracket™ (Type 2) – Large	21"	240#	EA	1

**Base Pad**

Used as a mounting base when condensing units must be bolted down. Maximum load capacity is 220 lbs. per pad. Sliding rail design for easy and fast installation. Includes mounting bolts. Available in 14" and 17" lengths. Ivory color.



**230-BP14W**

CATALOG NO.	DESCRIPTION	UOM	ORDER MULTIPLE
<b>230-BP14W</b>	14" Base Pad, pack of 2	PK	10
<b>230-BP17W</b>	17" Base Pad, pack of 2	PK	10

**Hef-T-Bracket™ (Type 2)**

Used for supporting condensing units, Hef-T-Brackets (Type 2) feature a cross bar that is attached to a wall, and two L shaped brackets that are hooked and bolted into place on the cross bar. The condensing unit is mounted onto the L shaped brackets, and fastened using the bolts and anti vibration washers provided.



**230-B2L**

CATALOG NO.	DESCRIPTION	ARM LENGTH	LOAD RATING PER ARM	UOM	ORDER MULTIPLE
<b>230-B2M</b>	Hef-T-Bracket™ (Type 2) – Medium	18"	165#	EA	1
<b>230-B2L</b>	Hef-T-Bracket™ (Type 2) – Large	21"	220#	EA	1

**Hef-T-Bracket™ (Type 3)**

Used for supporting condensing units, Hef-T-Brackets (Type 3), just like Hef-T-Brackets (Type 2), feature a cross bar that is attached to a wall, and two L shaped brackets that are hooked and bolted into place on the cross bar. The condensing unit is mounted onto the L shaped brackets, and fastened using the bolts and anti vibration washers provided. The Hef-T-Bracket™ (Type 3) features an innovative locking mechanism called Easy Fit™. Easy Fit™ enables the arms to be joined to the uprights in a matter of seconds. A spring lock automatically secures the joint, preventing the arms from being dislodged accidentally. All brackets are furnished complete with an integral bubble level to make correct installation of the crossbar easier.



**230-B3L**



CATALOG NO.	DESCRIPTION	ARM LENGTH	LOAD RATING PER ARM	UOM	ORDER MULTIPLE
<b>230-B3M</b>	Hef-T-Bracket™ (Type 3) – Medium	19"	100#	EA	1
<b>230-B3L</b>	Hef-T-Bracket™ (Type 3) – Large	21"	150#	EA	1

ANTI-VIBRATION PADS

**E.V.A. Anti-Vibration Pad**

The latest generation in vibration dampening technology. The most effective vibration dampening pad available on the market. The EVA Pad was tested against other pads at four different vibration settings. In the most severe vibration extremes, the EVA Pad outperforms cork and rubber by a margin of greater than 3:1! This is due to the special composite foam center which is much more structurally sound than cork. It is not affected by oils or chemicals that can break down cork and is much more effective at vibration dampening than solid rubber. All this at a very competitive price. Designed to withstand 50 psi.

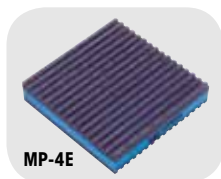

CATALOG NO.	DESCRIPTION	UOM	ORDER MULTIPLE
<b>MP-2E</b>	2" x 2" x 7/8" E.V.A. Pad	EA	48
<b>MP-3E</b>	3" x 3" x 7/8" E.V.A. Pad	EA	36
<b>MP-4E</b>	4" x 4" x 7/8" E.V.A. Pad	EA	24
<b>MP-6E</b>	6" x 6" x 7/8" E.V.A. Pad	EA	24
<b>MP-12E</b>	12" x 12" x 7/8" E.V.A. Pad	EA	12
<b>MP-18E</b>	18" x 18" x 7/8" E.V.A. Pad	EA	6

**Rubber Anti-Vibration Pad**

Highest quality elastomeric oil resistant padding. Designed to withstand 50 lbs. psi. The rubber pads are corrugated on both sides. Ideal for air conditioners, compressors, cooling towers, presses, machines, etc.



CATALOG NO.	DESCRIPTION	UOM	ORDER MULTIPLE
<b>MP-2</b>	2" x 2" x 3/8" Rubber	EA	48
<b>MP-3</b>	3" x 3" x 3/8" Rubber	EA	36
<b>MP-4</b>	4" x 4" x 3/8" Rubber	EA	24
<b>MP-6</b>	6" x 6" x 3/8" Rubber	EA	24
<b>MP-8</b>	8" x 8" x 3/8" Rubber	EA	12
<b>MP-12</b>	12" x 12" x 3/8" Rubber	EA	12
<b>MP-18</b>	18" x 18" x 3/8" Rubber	EA	6

**Rubber/Cork Anti-Vibration Pad**

Highest quality elastomeric oil resistant padding. Designed to withstand 50 psi. The rubber pads are corrugated on both sides. The cork is laminated between two corrugated pads. Ideal for air conditioners, compressors, cooling towers, presses, machines, etc.

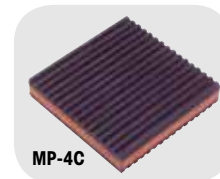

CATALOG NO.	DESCRIPTION	UOM	ORDER MULTIPLE
<b>MP-2C</b>	2" x 2" x 7/8" Rubber/Cork	EA	48
<b>MP-3C</b>	3" x 3" x 7/8" Rubber/Cork	EA	36
<b>MP-4C</b>	4" x 4" x 7/8" Rubber/Cork	EA	24
<b>MP-6C</b>	6" x 6" x 7/8" Rubber/Cork	EA	24
<b>MP-8C</b>	8" x 8" x 7/8" Rubber/Cork	EA	12
<b>MP-12C</b>	12" x 12" x 7/8" Rubber/Cork	EA	12
<b>MP-18C</b>	18" x 18" x 7/8" Rubber/Cork	EA	6

**Iso-Cube Economy Anti-Vibration Pad**

Natural rubber pads, designed to reduce vibration and noise emanating from refrigeration and air conditioning equipment. The circular design in each pad offers a suction cup effect, which eliminates the need to bolt the pads down. A standard 18" (46cm) pad is divided into eighty-one 2" (5cm) segments, each of which may be cut or torn to provide smaller pads. These 50 durometer pads will withstand a load of 180 psi with greater resiliency.



CATALOG NO.	DESCRIPTION	UOM	ORDER MULTIPLE
<b>ISO-2</b>	2" x 2" x 3/4" Iso-Cube	EA	24
<b>ISO-4</b>	4" x 4" x 3/4" Iso-Cube	EA	12
<b>ISO-18</b>	18" x 18" x 3/4" Iso-Cube	EA	6

# AIR MOVEMENT

Dryer Duct, Vent Hose, Hose Clamps ..... 32-33  
Duct Strap, Ties, Clamps ..... 33-34  
Permanent Air Filters..... 35  
Pure-Beam™ Ultraviolet Light ..... 32  
Tapes ..... 36  
Ventilation Products..... 31



# PURE-BEAM™ Ultraviolet Light

*The Pure-Beam™ ultraviolet light is designed for HVAC air disinfection and surface irradiation. Exposure to Pure-Beam™ significantly reduces air contamination caused by fungus, mold, and viruses and can cleanse surfaces overcome by mold and slime.*

- The Pure-Beam™ ultraviolet light is an excellent way to maintain indoor air quality.
- This UV Light includes a ballast, transformer, and bracket for even more convenience.
- Overall dimensions are small which makes installation easy.
- The included transformer allows operation using 120, 208, and 240/220 VAC power.
- UV lights are unobtrusive and transparent in operation, requiring little maintenance.

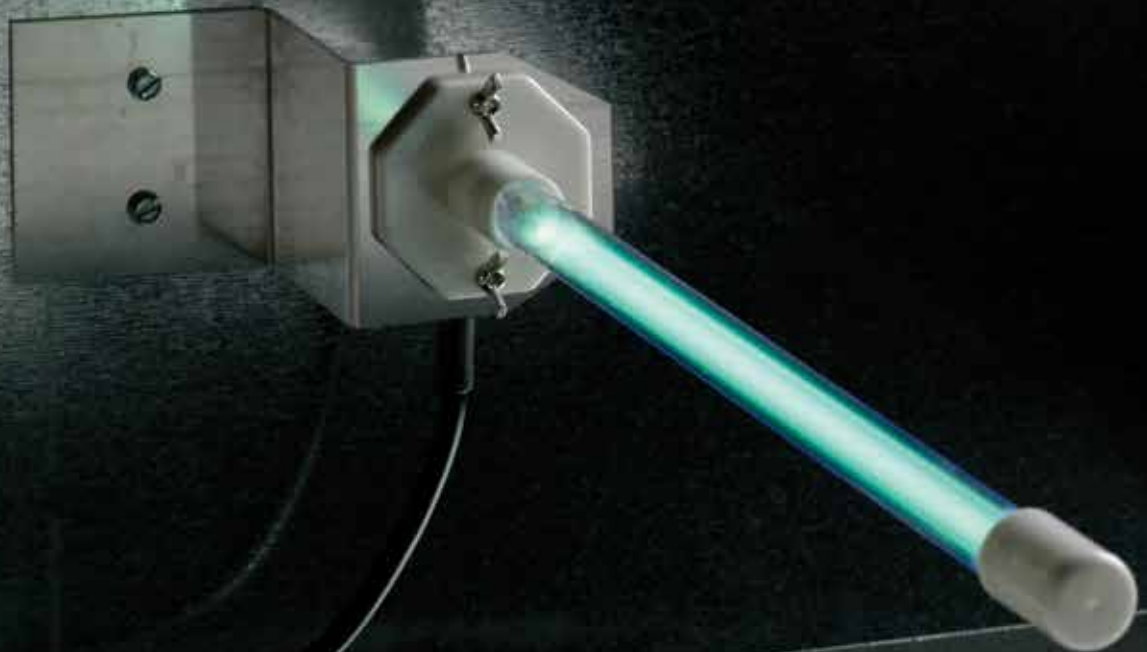



### Duct Fans

• Features electrical junction box for UL and code compliant electrical connection. An efficient way to increase air circulation, keep room temperatures consistent, and lower heating and cooling costs. Metal construction, powerful no-maintenance motors and a one-use thermal fuse mean these fans will be up to the task for years. Straightforward installation into any 120V system with detailed instructions, templates, and diagrams. Available in many sizes. A great way to give slow vents a boost. Conforms to UL STD 507, Certified to CSA STD C22.2 #113

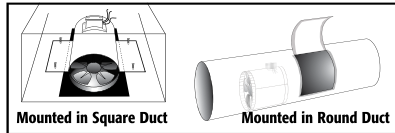

CATALOG NO.	DESCRIPTION	UOM	ORDER MULTIPLE
625-AF6	Duct Fan 6" dia., 240 CFM, 37W	EA	4
625-AF8	Duct Fan 8" dia., 420 CFM, 37W	EA	4
625-AF10	Duct Fan 10" dia., 650 CFM, 35W	EA	4
625-AF12	Duct Fan 12" dia., 975 CFM, 65W	EA	2
625-AF14	Duct Fan 14" dia., 1350 CFM, 65W	EA	1

### Roof Flashing

Easy to install. The no-caulk flashing slips over vent stack and automatically adjusts to pipe size and roof angle. 24 gauge galvanized steel.



Oatey

CATALOG NO.	DESCRIPTION	UOM	ORDER MULTIPLE
5-11830	Roof Flashing – 1/2" – 3/4" – 1"	EA	12
5-11840	Roof Flashing – 1-1/4" – 1-1/2"	EA	12
5-11853	Roof Flashing – 2"	EA	12
5-11866	Roof Flashing – 3"	EA	12
5-11879	Roof Flashing – 4"	EA	12

### Roof Louver

Unique interior louver design, eliminating the need for a screen. The square hood has been designed for maximum air movement. Large nailing flange for easy installation. U.L. Listed.



LESIE LOCKE

CATALOG NO.	DESCRIPTION	UOM	ORDER MULTIPLE
6-R50A	Roof Louver – Aluminum	EA	10

### Flue Caps

PVC Flue Caps are an affordable way to protect today's high efficiency furnaces from dirt, moisture and other debris.

- Protection for high efficiency furnaces
- Universal flue cap fits 1.5", 2" and 3" PVC pipe
- Reduces draft inducer motor rust
- Helps to eliminate pressure switch service calls
- Resistant to UV radiation and oxidative degradation
- CSA approved for use in 90% AFUE heating applications



CATALOG NO.	DESCRIPTION	UOM	ORDER MULTIPLE
EC-1	E cap Flue Cap	EA	12

### Smokeys

Smoke emitter cartridges provide effective, low cost leak testing of heat exchangers, air ducts, tanks and boilers. Visual air balancing of HVAC systems. Cartridges produce clean, non toxic, oil free smoke through chemical reaction. Use also for fire drills as well as the placement and testing of smoke alarms/ detectors.



CATALOG NO.	DESCRIPTION	UOM	ORDER MULTIPLE
14145	45 second burn time, 150 cu. ft., pack of 10	PK	1
14175	75 second burn time, 600 cu. ft., pack of 10	PK	1
14250	2-1/2 minute burn time, 1,100 cu. ft., pack of 5	PK	1
14340	4 minute burn time, 2,500 cu. ft., pack of 5	PK	1
14460	8 minute burn time, 18,000 cu. ft.	EA	1

### Versa Cap® Flue and Hot Stack Caps

Non clogging positive draft design, recommended for flue or hot stack installation. Clamp fitting adjustable for all standard sizes. Aluminum model. U.L. Listed.



6-3050

LESIE LOCKE

CATALOG NO.	PIPE O.D.	DOUBLE WALL	SINGLE WALL	J-M TRANS. SITE	HEIGHT/OVERALL DIAMETER	ORDER UOM MULTIPLE
6-3050	2-7/8"–5"	3 and 4	3 and 4	3 and 4	4-1/2" x 6-5/8"	EA 12
6-5070	4-7/8"–7"	5 and 6	5 and 6	5 and 6	4-3/4" x 9-1/2"	EA 12
6-7090	6-7/8"–9"	7 and 8	7 and 8	7 and 8	5-7/8" x 11-5/8"	EA 12
6-9011	8-7/8"–11"	9 and 10	9 and 10	9 and 10	6-1/2" x 12-3/4"	EA 6
6-1200	11-7/8"–14-1/2"	12	12 and 14	12	8-11/16" x 17-9/16"	EA 2

### Egg Crate Louvers – Air Return Diffusers

White polystyrene 1/2 in. open cell grid louvers are beneficial for air return.

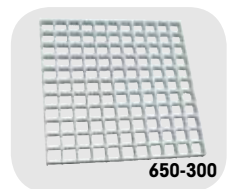

650-300

CATALOG NO.	DESCRIPTION	UOM	ORDER MULTIPLE
650-300	Egg Crate Louvers – 2' x 2' x 1/2"	EA	20
650-200	Egg Crate Louvers – 2' x 4' x 3/8"	EA	15
650-100	Egg Crate Louvers – 2' x 4' x 1/2"	EA	10

**PURE BEAM™ ULTRAVIOLET LIGHT**

**Pure-Beam™ Ultraviolet Light**

Pure Beam™ ultraviolet light is designed for HVAC air disinfection and surface irradiation. The 17 watt UV C lamp is a powerful tool for improved indoor air quality. Installs in the HVAC system or ductwork on either the return or supply air side of the furnace or air handler. DiversiTech's Pure Beam™ ultraviolet light provides a healthier environment in your home, thanks to the germicidal qualities of the UV light spectrum present in the Pure Beam™ light. Ultraviolet light deactivates the DNA of dust mites, bacteria, viruses and other pathogens and destroys their ability to multiply and cause disease. Placement of a Pure Beam™ light in an airstream or near a drain pan can help to decrease the air contamination of any home. Exposure to Pure Beam™ significantly reduces air contamination caused by fungus, mold, and viruses and can cleanse surfaces overcome by mold and slime. Overall size is 14 in. L x 2 in. W x 2 in. H for easy placement. Includes the UV lamp, a UL listed ceramic base, and mounting bracket.



UV-1

CATALOG NO.	DESCRIPTION	UOM	ORDER MULTIPLE
UV-1	Ultraviolet Light with 24 VAC elec. ballast	EA	1
UV-BULB	Replacement Bulb – 24V	EA	1

**DRYER DUCT, VENT HOSE, HOSE CLAMPS**

**Aluminum Dryer Vent Hoods, Kits, and Fittings**

Aluminum vent hood with flange plate. Kits include flexible vinyl tubing and two clamps.

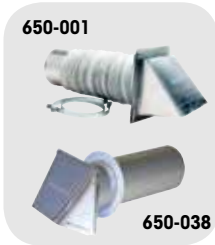

CATALOG NO.	DESCRIPTION	UOM	ORDER MULTIPLE
650-001	4" Aluminum Hood	EA	12
650-002	3" Aluminum Hood	EA	12
650-003	4" Hood / 8' Tubing	EA	1
650-004	4" Hood / 5' Tubing	EA	1
650-038	4" Aluminum Wide Mouth	EA	10

**Plastic Wide Mouth Dryer Vent Hood**

Hood, aluminum pipe and collar.

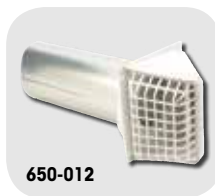

650-012

CATALOG NO.	DESCRIPTION	UOM	ORDER MULTIPLE
650-031	3" White Hood – Assembled	EA	12
650-012	4" White Hood – Assembled	EA	12
650-013	4" White Hood – Unassembled	EA	18
650-023	4" Brown Hood – Assembled	EA	12

**Dryer Vent Hose**

High quality flexible white vinyl tubing. Available in 3in. or 4in. diameters. One 50ft roll per box.



650-005

CATALOG NO.	DESCRIPTION	UOM	ORDER MULTIPLE
650-005	Dryer Vent Hose – 3" x 50'	EA	1
650-006	Dryer Vent Hose – 4" x 50'	EA	1

**Semi-Rigid Aluminum Duct**

8ft. length compressed to 28in.



650-011

CATALOG NO.	DESCRIPTION	UOM	ORDER MULTIPLE
650-011	4" x 8' Flexible Aluminum Duct	EA	9
650-021	3" x 8' Flexible Aluminum Duct	EA	14
650-074	6" x 8' Flexible Aluminum Duct	EA	3

**DRYER DUCT, VENT HOSE, HOSE CLAMPS cont'd**

**Louvered Dryer Vent Hood**

Louvered vent hoods are available with aluminum pipe and collar or hood only. Ideal for dryer and bathroom fan exhausts.



CATALOG NO.	DESCRIPTION	UOM	ORDER MULTIPLE
<b>650-014</b>	4" Hood Only – White	EA	12
<b>650-015</b>	4" Hood Only w/Bird Guard – White	EA	12
<b>650-016</b>	4" Hood, Pipe and Collar – White (Assembled)	EA	12
<b>650-017</b>	4" Hood, Pipe and Collar – White (Unassembled)	EA	18
<b>650-036</b>	3" Hood, Pipe and Collar – White (Assembled)	EA	12

**Dryer Hose Clamps**

Available for 3 in. or 4in. dryer vent hose. Steel screw design or convenient spring action design.



CATALOG NO.	DESCRIPTION	UOM	ORDER MULTIPLE
<b>650-008</b>	Steel Screw Clamp for 4" Hose	EA	50
<b>650-010</b>	Spring Clamp for 4" Hose	EA	500

**Metallic Duct – 5 Ply**

Pure aluminum 5 ply multi layered flexible metallic duct. U.L. 181 Listed. Will contain a fire up to 265°F.



CATALOG NO.	DESCRIPTION	UOM	ORDER MULTIPLE
<b>FUL0425</b>	4" x 25' 5 Ply Metallic Duct	EA	4
<b>FUL0625</b>	6" x 25' 5 Ply Metallic Duct	EA	4

**Periscope Connection Kit**

For tight space duct venting. Contains one male snap lock fitting and one draw band with clamp. Adjustable 17in. to 28in..



CATALOG NO.	DESCRIPTION	UOM	ORDER MULTIPLE
<b>650-020</b>	4" Periscope Kit	EA	9

**Metallic Duct – 2 Ply**

2 ply metallic duct — aluminum outside, polyester inside. Ideal for bath fan ducting and all purpose venting.



CATALOG NO.	DESCRIPTION	UOM	ORDER MULTIPLE
<b>FM0450</b>	4" x 50' 2 Ply Metallic Duct	EA	1

**DUCT STRAP, TIES, CLAMPS**

**Heavy Duty Cable Ties**

6.6 nylon, the heavy duty duct straps feature smooth insertion, and a locking mechanism that gives ductwork a firm hold. Accommodates 7 to 15 inch duct. Tensioning tool for 32 in. plus allows operator to adjust strap to any desired tension.

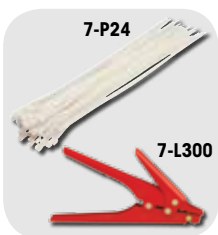

CATALOG NO.	DESCRIPTION	UOM	ORDER MULTIPLE
<b>7-P24</b>	24" Long – Fits up to 6" Duct – 175 lb. Tensile	EA	50
<b>7-P36</b>	36" Long – Fits up to 10" Duct – 175 lb. Tensile	EA	50
<b>7-P36B</b>	36" Long – Black – Fits up to 10" Duct – 175 lb. Tensile	EA	50
<b>7-P48</b>	48" Long – Fits up to 14" Duct – 175 lb. Tensile	EA	50
<b>7-P48B</b>	48" Long – Black – Fits up to 14" Duct – 175 lb. Tensile	EA	25
<b>7-L300</b>	Tensioning Tool for 120-175 lb. Ties	EA	1

**Cable Tie Holder**

Finally an easier way to hold 24" to 48" cable ties. Easy to carry across your back or around your waist.



CATALOG NO.	DESCRIPTION	UOM	ORDER MULTIPLE
<b>CTH-1</b>	Cable Tie Holder	EA	1

**Strapping Hanger Iron**

Galvanized 3/4 in. vent strapping, hanger iron, plumber's tape, pipe hanger tape and many other uses. 1/4 in. centers for bolts or nails.



CATALOG NO.	DESCRIPTION	UOM	ORDER MULTIPLE
<b>710-A1710</b>	Hanger Iron (Galv.) – 10' Rolls – 28 Gauge	EA	50
<b>710-A1650</b>	Hanger Iron (Galv.) – 50' Rolls – 28 Gauge	EA	10
<b>710-A16100</b>	Hanger Iron (Galv.) – 100' Rolls – 28 Gauge	EA	6

**DUCT STRAP, TIES, CLAMPS** cont'd

**Hanging Wire**

The 18 gauge galvanized can be used to hang HVAC duct work.



CATALOG NO.	DESCRIPTION	UOM	ORDER MULTIPLE
<b>710-182G</b>	2# Roll – 330' – 18 Gauge Galvanized	EA	8
<b>710-185G</b>	5# Roll – 830' – 18 Gauge Galvanized	EA	8

**Duct Strap – Woven Polypropylene**

Webbed duct strap possessing high tensile and abrasion resistance. This can be used for flex duct as it is easy to cut and staple to joists. The product is chemical resistant and listed to spec 2040.



CATALOG NO.	DESCRIPTION	UOM	ORDER MULTIPLE
<b>710-100</b>	Duct Strap – 1-3/4" x 100 Yards – Black	EA	24
<b>710-101</b>	Duct Strap – 1-3/4" x 100 Yards – Silver	EA	24
<b>710-102</b>	Duct Strap – 3" x 100 Yards – Black	EA	8
<b>710-103</b>	Duct Strap – 3" x 100 Yards – Silver	EA	8

**Duct Strap – Metallic – Roll**

Galvanized duct strap in a convenient cardboard dispenser is not only easy to drill or nail, but also solid strapping. Plenum rated.



CATALOG NO.	DESCRIPTION	UOM	ORDER MULTIPLE
<b>710-001</b>	Metallic Duct Strap – 26 Gauge – 1" x 100'	EA	1
<b>710-002</b>	Metallic Duct Strap – 30 Gauge – 1" x 100'	EA	1
<b>710-003</b>	Metallic Duct Strap – 30 Gauge – 1-1/2" x 100'	EA	1
<b>710-004</b>	Metallic Duct Strap – 26 Gauge – 1-1/2" x 100'	EA	1
<b>710-005</b>	Metallic Duct Strap – 22 Gauge – 1" x 100'	EA	1

**Plastic Hanger Strap**

Flexible, non-conductive. 3/4 in. wide x .050 in. thick. Load tested to 120 lbs.



CATALOG NO.	DESCRIPTION	UOM	ORDER MULTIPLE
<b>710-P100</b>	3/4" x 100' Roll	EA	20

## PERMANENT AIR FILTERS

Every filter makes trade-offs between letting too much air through (good for the unit) and trapping too much "stuff" (good for the homeowner). Where is the right balance? What is best for the homeowner and their unit? DiversiTech offers two permanent air filters. Choose the Red Label Filter for a good balance between ample air flow and ability to trap dust. Choose the Blue Label Filter if you feel greater air flow is needed, perhaps for older units.

### Blue Label Permanent Air Filters

The Blue Label Permanent Air Filters offer a 0.08 Initial Resistance. Blue Label Filters offer Peak Dust Arrestance of 73% with the average being 67%. The Dust Holding Capacity is 99 gm. These filters are perfect for units that need a greater air flow.



CATALOG NO.	1" NOMINAL SIZE	DESCRIPTION	UOM	ORDER MULTIPLE
AFB1212-1	12" x 12" x 1"	Blue Label Permanent Air Filter	EA	1
AFB1220-1	12" x 20" x 1"	Blue Label Permanent Air Filter	EA	1
AFB1224-1	12" x 24" x 1"	Blue Label Permanent Air Filter	EA	1
AFB1420-1	14" x 20" x 1"	Blue Label Permanent Air Filter	EA	1
AFB1424-1	14" x 24" x 1"	Blue Label Permanent Air Filter	EA	1
AFB1425-1	14" x 25" x 1"	Blue Label Permanent Air Filter	EA	1
AFB1520-1	15" x 20" x 1"	Blue Label Permanent Air Filter	EA	1
AFB1624-1	16" x 24" x 1"	Blue Label Permanent Air Filter	EA	1
AFB1625-1	16" x 25" x 1"	Blue Label Permanent Air Filter	EA	1
AFB1818-1	18" x 18" x 1"	Blue Label Permanent Air Filter	EA	1
AFB2024-1	20" x 24" x 1"	Blue Label Permanent Air Filter	EA	1
AFB2025-1	20" x 25" x 1"	Blue Label Permanent Air Filter	EA	1
AFB2030-1	20" x 30" x 1"	Blue Label Permanent Air Filter	EA	1
AFB2424-1	24" x 24" x 1"	Blue Label Permanent Air Filter	EA	1
AFB2525-1	25" x 25" x 1"	Blue Label Permanent Air Filter	EA	1
AFB-CUSTOM-1	Custom 1"	Blue Label Permanent Air Filter	EA	1
AFB-CUSTOM-2	Custom 2"	Blue Label Permanent Air Filter	EA	1

2" Blue Label Permanent Air Filters are available in all above sizes. Specify 2" when ordering.

### Red Label Permanent Air Filters

The Red Label Permanent Air Filters offer a 0.12 Initial Resistance. Red Label Filters offer Peak Dust Arrestance is 82% with the average being 76%. The Dust Holding Capacity is 147 gm. These filters have a good balance between ample air flow and the ability to trap dust.



CATALOG NO.	1" NOMINAL SIZE	DESCRIPTION	UOM	ORDER MULTIPLE
AFR1220-1	12" x 20" x 1"	Red Label Permanent Air Filter	EA	1
AFR1224-1	12" x 24" x 1"	Red Label Permanent Air Filter	EA	1
AFR1420-1	14" x 20" x 1"	Red Label Permanent Air Filter	EA	1
AFR1424-1	14" x 24" x 1"	Red Label Permanent Air Filter	EA	1
AFR1425-1	14" x 25" x 1"	Red Label Permanent Air Filter	EA	1
AFR1430-1	14" x 30" x 1"	Red Label Permanent Air Filter	EA	1
AFR1520-1	15" x 20" x 1"	Red Label Permanent Air Filter	EA	1
AFR1620-1	16" x 20" x 1"	Red Label Permanent Air Filter	EA	1
AFR1625-1	16" x 25" x 1"	Red Label Permanent Air Filter	EA	1
AFR1824-1	18" x 24" x 1"	Red Label Permanent Air Filter	EA	1
AFR1825-1	18" x 25" x 1"	Red Label Permanent Air Filter	EA	1
AFR2020-1	20" x 20" x 1"	Red Label Permanent Air Filter	EA	1
AFR2024-1	20" x 24" x 1"	Red Label Permanent Air Filter	EA	1
AFR2025-1	20" x 25" x 1"	Red Label Permanent Air Filter	EA	1
AFR2030-1	20" x 30" x 1"	Red Label Permanent Air Filter	EA	1
AFR2525-1	25" x 25" x 1"	Red Label Permanent Air Filter	EA	1
AFR-CUSTOM-1	Custom 1"	Red Label Permanent Air Filter	EA	1
AFR-CUSTOM-2	Custom 2"	Red Label Permanent Air Filter	EA	1

2" Red Label Permanent Air Filters are available in all above sizes. Specify 2" when ordering.

#### LIMITED LIFETIME WARRANTY

DiversiTech hereby guarantees to the original purchaser that this DiversiTech permanent air filter will remain free of defects in materials and workmanship, when used in accordance with the recommended guidelines, for the life of the unit on which it is installed. Should this air filter be found to be defective, the remedies of the original purchaser are expressly limited to having DiversiTech replace the filter free of charge. To obtain the replacement filter, the original purchaser must return the defective filter to DiversiTech, 2175 East Park Drive, Conyers, GA 30013, with postage charges prepaid.

The warranty does not include the cost of installing the DiversiTech permanent air filter or any other costs, all of which shall be borne by the original purchaser. This warranty does not cover damage due to abuse, improper installation, installation in other than standard residential air conditioning and/or heating units, cleaning by high pressure hose or sprays or by use of highly caustic or corrosive cleaning agents.

DiversiTech makes no other warranty whatsoever and all other warranties of merchantability and fitness whether expressed or implied are limited to the life of the original air conditioning or heating unit on which the DiversiTech permanent air filter is installed.

TAPES

**Stick-E-Tape**

Self adhesive aluminum tape with temperature range of 40 degree F to 200 degree F. Easily painted. Excellent vapor barrier; effective UV and water shield over urethane foam. Preferred duct and pipe wrap.



50302

CATALOG NO.	DESCRIPTION	UOM	ORDER MULTIPLE
50302	Stick-E-Tape – AFT-701-2 – 2” x 50’ Roll	EA	24

**Flex Duct Tape**

Specially designed to meet new UL181B FX code for flex duct. Higher adhesion and tack than traditional cloth duct tapes. Conformable, hand tearable foil; 3 mil thickness. 2 in. x 120 yds. Code identification printed on the tape. Acrylic adhesive for superior performance in extreme environments. ( 35°F to 260°F)



640-FD2S

CATALOG NO.	DESCRIPTION	UOM	ORDER MULTIPLE
640-FD2S	Flex Duct Tape – Silver – 2”	EA	24
640-FD2B	Flex Duct Tape – Black – 2”	EA	24
640-FD3S	Flex Duct Tape – Silver – 3”	EA	16
640-FD3B	Flex Duct Tape – Black – 3”	EA	16

**UL Listed Foil Tape**

Unique acrylic adhesive for airtight bonds on joints and seams of fiberglass duct systems. Flexible, easy to use. Meets or exceeds performance standard AFLS 100 73 and UL 181 A P.



640-UL25

CATALOG NO.	DESCRIPTION	UOM	ORDER MULTIPLE
640-UL25	UL 181 Listed Foil Tape – 2-1/2” – 60 Yards	EA	16
640-UL3	UL 181 Listed Foil Tape – 3” – 60 Yards	EA	16

**Aluminum Foil Tape**

Prevents heating and cooling losses. Blocks odors and moisture. Easy to handle. Use for HVAC and refrigeration systems. 35 degree F to plus 260 degree F working temperatures. 3-5 year shelf life. Made in USA.



640-AF2

CATALOG NO.	DESCRIPTION	UOM	ORDER MULTIPLE
640-AF2	2” Aluminum Foil Tape – 50 yds.	EA	24
640-AF25	2-1/2” Aluminum Foil Tape – 50 yds.	EA	20
640-AF3	3” Aluminum Foil Tape – 50 yds.	EA	16

**Foil Scrim Kraft Tape**

Non tearable, diamond patterned backing with an aggressive rubber based adhesive system for consistently dependable performance. Made in the USA.



640-FSK2

CATALOG NO.	DESCRIPTION	UOM	ORDER MULTIPLE
640-FSK2	Foil Scrim Kraft Tape – 2” – 50 Yards	EA	24
640-FSK3	Foil Scrim Kraft Tape – 3” – 50 Yards	EA	16

**Cloth Duct Tapes**

High tack, excellent strength. Superior performance in sealing air handling systems. Heavy cloth content for easier tearing and additional strength. Made in the USA.

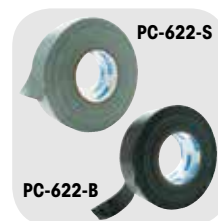

PC-622-S

PC-622-B

CATALOG NO.	DESCRIPTION	UOM	ORDER MULTIPLE
PC-622-S	2” x 60 Yards – Premium Grade Duct Tape – Silver	EA	24
PC-622-B	2” x 60 Yards – Premium Grade Duct Tape – Black	EA	24
PC-609-S	2” x 60 Yards – Industrial Grade Duct Tape – Silver	EA	24
PC-609-B	2” x 60 Yards – Industrial Grade Duct Tape – Black	EA	24
PC-600-S	2” x 60 Yards – Contractor Grade Duct Tape – Silver	EA	24
PC-600-B	2” x 60 Yards – Contractor Grade Duct Tape – Black	EA	24
PC-857	2” x 60 Yards – Metallized UL181B-FX Flex Duct Tape	EA	24

# HEATING PRODUCTS

Black Steel Welded Nipples..... 43  
 Carbon Monoxide & Smoke Alarms..... 41  
 Diversitech Gas Connectors..... 42  
 Dormont Gas Valves and Connectors..... 42-43  
 Malleable Black Iron and Steel Pipe Fittings..... 43-44  
 TrueStart Hot Surface Igniters .....40  
 TrueStart Ignition Accessories..... 40-41  
 Vent Termination Kits..... 41

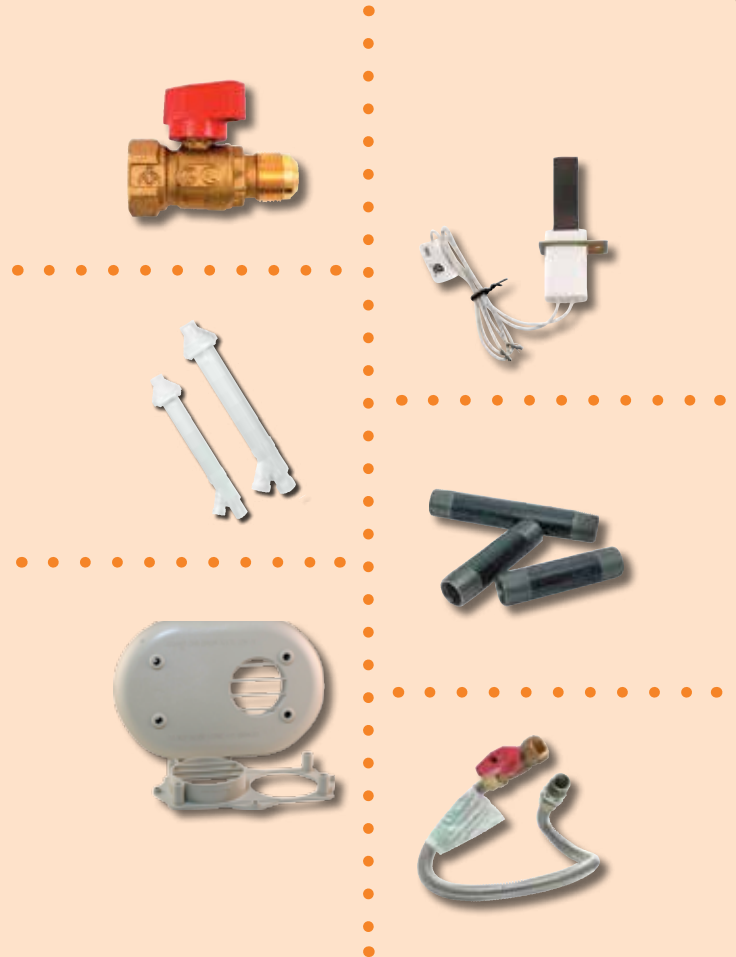

# TrueStart® Hot Surface Igniters



*TrueStart® hot surface igniters have been  
100% tested and approved.*

*TrueStart® hot surface igniters are completely reliable  
right out of the package and are certified by CSA  
for use in electrical equipment.*







TrueStart® universal hot surface igniters by DiversiTech are high quality replacements that fit hundreds of OEM components. TrueStart® universal igniters are durable and are designed to provide years of reliable service.

## BUILT TO LAST

TrueStart® universal igniters are available in silicon nitride and silicon carbide models. Silicon nitride is a very durable ceramic that is high fracture and temperature resistant and has a long life expectancy. Silicon nitride is a longer lasting material that is also more shock resistant. Silicon carbide is a naturally high temperature resistant metal that has been the standard used in heating equipment for years.

## JUST ONE REPLACES HUNDREDS

TrueStart® universal hot surface igniters feature a universal bracket kit that can be used to fit most all OEM furnaces. And TrueStart® hot surface igniters feature a unique universal electrical plug kit. This plug kit includes the most common crimp terminals and connector housings to fit the majority of OEM furnaces.

- ✓ *Durable ceramic material*
- ✓ *High thermal shock and chemical resistance*
- ✓ *Fracture resistant*
- ✓ *Long life*

## LONG WARRANTY

Every TrueStart® universal igniter includes a generous warranty period to ensure your satisfaction. The warranty on silicon nitride models is 3 full years and the warranty for silicon carbide igniters is 18 months.

## 100% TESTED

TrueStart® universal hot surface igniters have been 100% tested and approved. TrueStart® hot surface igniters are completely reliable right out of the package and are certified by CSA for use in electrical equipment.



*Each TrueStart® universal igniter also includes:*



*A universal bracket kit for a fast, easy installation.*



*A universal electrical plug connection kit to simplify installation.*



*Color coded packaging.*



**Made in U.S.A.**



**TRUESTART® HOT SURFACE IGNITERS**

**Wolverine® Universal Hot Surface Igniter**

Wolverine® hot surface igniters feature protective, dynamic, and informative packaging. Wolverine® hot surface igniters are 100% tested and completely reliable. They are compatible with all OEM furnaces. Universal hot surface igniters allow a contractor to reduce truck stock and replace hundreds of OEM igniters with just one SKU.

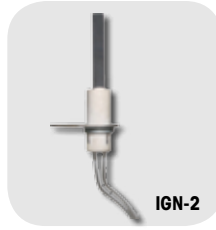

CATALOG NO.	DESCRIPTION	UOM	ORDER MULTIPLE
<b>IGN-2</b>	Wolverine Hot Surface Igniter by TrueStart, Universal, Silicon Nitride	EA	6
<b>IGN-2-6P</b>	Wolverine Hot Surface Igniter by TrueStart, Universal, Silicon Nitride – Contractor Pack, pack of 6	PK	1

**TrueStart™ Hot Surface Igniters**

TrueStart™ hot surface igniters feature protective, dynamic, and informative packaging. TrueStart™ hot surface igniters are 100% tested and completely reliable. They are compatible with all OEM furnaces. TrueStart™ hot surface igniters are available as direct replacement for OEM (silicon carbide) or as a universal igniter (silicone carbide or silicon nitride). Universal hot surface igniters allow a contractor to reduce truck stock and replace hundreds of OEM igniters with just one SKU



CATALOG NO.	DESCRIPTION	UOM	ORDER MULTIPLE
<b>IGN-1F</b>	TrueStart™ Hot Surface Igniter, Universal, Flat, Silicon Nitride	EA	6
<b>IGN-1R</b>	TrueStart™ Hot Surface Igniter, Universal, Round, Silicon Nitride	EA	6

**Direct Replacement Igniters**

TrueStart® hot surface igniters feature protective, dynamic, and informative packaging. TrueStart™ hot surface igniters are 100% tested and completely reliable. They are compatible with all OEM furnaces. TrueStart® hot surface igniters are available as direct replacement for OEM silicon carbide igniters.



CATALOG NO.	DESCRIPTION	UOM	ORDER MULTIPLE
<b>IGN-401</b>	TrueStart™ Hot Surface Igniter, Direct Replacement, Silicon Nitride	EA	6
<b>IGN-402</b>	TrueStart™ Hot Surface Igniter, Direct Replacement, Silicon Nitride	EA	6
<b>IGN-403</b>	TrueStart™ Hot Surface Igniter, Direct Replacement, Silicon Nitride	EA	6
<b>IGN-409</b>	TrueStart™ Hot Surface Igniter, Direct Replacement, Silicon Nitride	EA	6

**Universal Silicon Carbide Igniters**

TrueStart® hot surface igniters feature protective, dynamic, and informative packaging. TrueStart™ hot surface igniters are 100% tested and completely reliable. They are compatible with all OEM furnaces. TrueStart® hot surface igniters are available as a universal silicon carbide igniter.

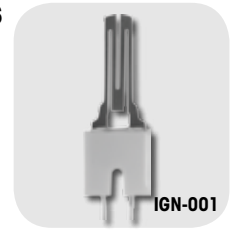

CATALOG NO.	DESCRIPTION	UOM	ORDER MULTIPLE
<b>IGN-001</b>	TrueStart™ Hot Surface Igniter, Universal, Silicon Carbide	EA	6

**TRUESTART® IGNITION ACCESSORIES**

**TrueStart® Pilot Burners**

TrueStart® pilot burners are a direct replacement for Carrier/BDP pilot burners. Available in 2 wire and 3 wire versions. The 3 wire is also field convertible to a 2 wire. TrueStart® pilot burners are not manufactured by Carrier Corporation.



CATALOG NO.	DESCRIPTION	UOM	ORDER MULTIPLE
<b>FC-73</b>	2 Wire Pilot Burner – Replacement for the Carrier® 732 2 wire pilot burner commonly known as Carrier®/BDP part number LH33JZ053	EA	1
<b>FC-74</b>	3 Wire Pilot Burner – Replacement for the Carrier® 740A 3 wire pilot burner commonly known as Carrier®/BDP part number LH680005	EA	1

**TrueStart® Blower on Relays**

TrueStart® blower on relays are direct replacements for Carrier/BDP blower on relays. TrueStart® blower on relays are not manufactured by Carrier Corporation.



CATALOG NO.	DESCRIPTION	UOM	ORDER MULTIPLE
<b>FC-82</b>	Blower on Relay – Replacement for the Carrier®/BDP 821 Blower on Relay commonly known as Carrier® part number HN680001	EA	1

**TRUESTART® IGNITION ACCESSORIES cont'd**

**TrueStart® Flame Sensors**

TrueStart® flame sensors are a direct replacement for Carrier/BDP flame sensors, cross reference part numbers are detailed in the item descriptions. TrueStart® flame sensors are not manufactured by Carrier Corporation.



CATALOG NO.	DESCRIPTION	UOM	ORDER MULTIPLE
900-3	TrueStart™ FLAME SENSOR replaces Carrier® LH33WZ516	EA	1
900-4	TrueStart™ FLAME SENSOR replaces Carrier® LH33WZ517	EA	1
900-5	TrueStart™ FLAME SENSOR replaces Carrier® LH33WZ518	EA	1
900-6	TrueStart™ FLAME SENSOR replaces Carrier® LH33WZ520	EA	1

**TrueStart® Spark Electrode**

Replacement pilots and accessories for selected Carrier/BDP units. Full 2 year warranty. Made in America.

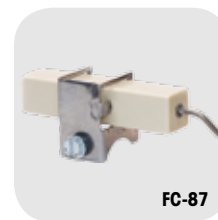

CATALOG NO.	DESCRIPTION	UOM	ORDER MULTIPLE
FC-87	Spark Electrode – Replacement for the Carrier®/BDP 871 Spark Electrode commonly known as Carrier®/BDP part number LH680512	EA	1

**VENT TERMINATION KITS**

**Concentric Vents**

Concentric vents make it easier to have a two pipe installation for high efficiency furnaces. These vents simplify installation and only require one hole through the wall or roof where the pipes terminate. Without using these vents, the installation would require cutting two holes through the home (2" or 3" depending on the furnace), one for each pipe. These vents save time and money by reducing the amount of work required. Available in 2" and 3" intake vent sizes.



CATALOG NO.	DESCRIPTION	UOM	ORDER MULTIPLE
CVENT-2	2" Concentric Vent	EA	4
CVENT-3	3" Concentric Vent	EA	4

**Horizontal Vent Termination Kits**

Horizontal vent kits for use in venting high efficiency fossil fuel appliances. The low profile kit hides the vent from view.



CATALOG NO.	DESCRIPTION	UOM	ORDER MULTIPLE
HVENT-2	Horizontal Termination Kit - 2 inch	EA	6
HVENT-3	Horizontal Termination Kit - 3 inch	EA	6

**CARBON MONOXIDE & SMOKE ALARMS**

**Carbon Monoxide Alarms**

Universal Security carbon monoxide alarms feature fast, easy installation, opto chemical sensor technology, easy access to the test/reset button, a loud 85 dB horn, and many more features. UL Listed, CSA approved.



CATALOG NO.	DESCRIPTION	UOM	ORDER MULTIPLE
CD-9000-B	CO Detector, battery operated	EA	6

**Combination Carbon Monoxide and Smoke Alarms**

- Combination Smoke and Carbon Monoxide Alarm
- Separate Sensors to Detect Smoke or Carbon Monoxide
- QUICK-DRAW® – convenient pull-out drawer for easy battery replacement
- Easy Battery Replacement
- Silencer Feature – convenient silencer button with automatic reset allows you to temporarily override smoke alarm—ideal for cooking smoke and fireplaces—eliminates nuisance alarms
- 9 Volt Super Heavy-Duty Battery Included
- LED Alarm Condition Indicators
- Loud 85 dB Alarm
- End-of-Life Notification – warns after approximately 6 years of operation from initial power up
- Test/Silence Button
- Five Year Limited Warranty
- MICN109 protects against natural gas as well



CATALOG NO.	DESCRIPTION	UOM	ORDER MULTIPLE
CD-9775-C	CO/Smoke Detector, battery operated	EA	6
MICN109	Smoke, Carbon Monoxide and Natural Gas Alarm	EA	6

**DIVERSITECH GAS CONNECTORS**

**DiversiTech Gas Connectors 1/2" OD**

Combining flexibility, durability, and functionality, DiversiTech stainless steel gas connectors are CSA design certified and 100% leak tested for quality and security. DiversiTech gas connectors are durable and reliable to give you everything you need. Available in a variety of sizes and lengths.



**D20-3132-18**

CATALOG NO.	DESCRIPTION	UOM	ORDER MULTIPLE
<b>D20-3132-18</b>	Gas Connector – 18" long, 1/2" OD x 3/8" ID, M x F	EA	12
<b>D20-3132-24</b>	Gas Connector – 24" long, 1/2" OD x 3/8" ID, M x F	EA	12
<b>D20-3132-36</b>	Gas Connector – 36" long, 1/2" OD x 3/8" ID, M x F	EA	12
<b>D20-3132-48</b>	Gas Connector – 48" long, 1/2" OD x 3/8" ID, M x F	EA	12

**Epoxy Coated Gas Connectors**

Yellow coated gas connectors include an epoxy coating for added durability and extra protection from corrosion, chemical stains from common household products and plumbing repairs.



**DC30-3132-18**

CATALOG NO.	DESCRIPTION	UOM	ORDER MULTIPLE
<b>DC30-3132-18</b>	Gas Connector coated – 18" long, 5/8" OD x 1/2" ID, M x F	EA	12
<b>DC30-3132-24</b>	Gas Connector coated – 24" long, 5/8" OD x 1/2" ID, M x F	EA	12
<b>DC30-3132-36</b>	Gas Connector coated – 36" long, 5/8" OD x 1/2" ID, M x F	EA	12
<b>DC30-3132-48</b>	Gas Connector coated – 48" long, 5/8" OD x 1/2" ID, M x F	EA	12

**DiversiTech Gas Connectors 5/8" OD**

Combining flexibility, durability, and functionality, DiversiTech stainless steel gas connectors are CSA design certified and 100% leak tested for quality and security. DiversiTech gas connectors are durable and reliable to give you everything you need. Available in a variety of sizes and lengths.



**D30-3132-18**

CATALOG NO.	DESCRIPTION	UOM	ORDER MULTIPLE
<b>D30-3131-24</b>	Gas Connector – 24" long, 5/8" OD x 1/2" ID, M x M	EA	12
<b>D30-3131-36</b>	Gas Connector – 36" long, 5/8" OD x 1/2" ID, M x M	EA	12
<b>D30-3131-48</b>	Gas Connector – 48" long, 5/8" OD x 1/2" ID, M x M	EA	12
<b>D30-3132-18</b>	Gas Connector – 18" long, 5/8" OD x 1/2" ID, M x F	EA	12
<b>D30-3132-24</b>	Gas Connector – 24" long, 5/8" OD x 1/2" ID, M x F	EA	12
<b>D30-3132-36</b>	Gas Connector – 36" long, 5/8" OD x 1/2" ID, M x F	EA	12
<b>D30-3132-48</b>	Gas Connector – 48" long, 5/8" OD x 1/2" ID, M x F	EA	12

**DORMONT GAS CONNECTORS AND VALVES**

**Dormont 20 Series**

1/2" O.D. x 3/8" I.D. 1/2" MIP x 1/2" FIP Connectors



**20-3132-18**

CATALOG NO.	DESCRIPTION	UOM	ORDER MULTIPLE
<b>20-3132-18</b>	Gas Connector – 18" Long	EA	12
<b>20-3132-24</b>	Gas Connector – 24" Long	EA	12
<b>20-3132-36</b>	Gas Connector – 36" Long	EA	12
<b>20-3132-48</b>	Gas Connector – 48" Long	EA	12

**Dormont 30 Series**

Corrugated, stainless steel connectors with special Supr Safe® design to increase flexibility. Maximum service and safety, approved for indoor or outdoor use. Perfect for range and furnace connection. AGA and CGA approved. 3131 Series: 5/8" O.D. x 1/2" I.D. 1/2" MIP x 1/2" FIP Connectors. 3132 Series: 7/8" O.D. x 1/2" I.D. 1/2" MIP x 1/2" FIP Connectors.



**30-3132-18**

CATALOG NO.	DESCRIPTION	UOM	ORDER MULTIPLE
<b>30-3131-24</b>	Gas Connector – 24" Long	EA	12
<b>30-3131-36</b>	Gas Connector – 36" Long	EA	12
<b>30-3131-48</b>	Gas Connector – 48" Long	EA	12
<b>30-3132-12</b>	Gas Connector – 12" Long	EA	12
<b>30-3132-18</b>	Gas Connector – 18" Long	EA	12
<b>30-3132-24</b>	Gas Connector – 24" Long	EA	12
<b>30-3132-30</b>	Gas Connector – 30" Long	EA	12
<b>30-3132-36</b>	Gas Connector – 36" Long	EA	12
<b>30-3132-48</b>	Gas Connector – 48" Long	EA	12
<b>30-3132-60</b>	Gas Connector – 60" Long	EA	12
<b>30-3132-72</b>	Gas Connector – 72" Long	EA	12

**DORMONT GAS CONNECTORS AND VALVES cont'd**

**Dormont 20 Series with Valve**

Corrugated stainless steel connectors with special Supr Safe design to increase flexibility. Maximum service and safety and is approved for both indoor and outdoor use. This is perfect for range and furnace connections. This Series is AA and CGA approved. This connector comes in 20 3135 18 1/2" O.D. x 3/8" I.D. x 1/2" FIP Ball Valve.



CATALOG NO.	DESCRIPTION	UOM	ORDER MULTIPLE
<b>20-3135-18</b>	Gas Connector – 18" Long	EA	12
<b>20-3135-24</b>	Gas Connector – 24" Long	EA	12
<b>20-3135-36</b>	Gas Connector – 36" Long	EA	12
<b>20-3135-48</b>	Gas Connector – 48" Long	EA	12

**Gas Ball Valve**

Gas Ball Valves meet the stringent ISO 9000 quality standard. AGA and CGA certified.



CATALOG NO.	DESCRIPTION	UOM	ORDER MULTIPLE
<b>91-3042</b>	5/8" O.D. Flare x 3/4" FIP for "30 Series" Gas Conn.	EA	10
<b>91-2032</b>	1/2" O.D. Flare x 1/2" FIP for "20 Series" Gas Conn.	EA	10
<b>92-3232</b>	1/2" FIP x 1/2" FIP	EA	10
<b>92-4242</b>	3/4" FIP x 3/4" FIP	EA	10

**BLACK STEEL WELDED NIPPLES**

**Black Steel Welded Nipples**

Welded Steel that withstands 700 PSI test pressure is perfect for everyday use. The specs for this product are ASTM A 120 (Nom B 10) and the thickness is Sch. 40.



CATALOG NO.	DESCRIPTION	UOM	ORDER MULTIPLE
<b>BPN-1</b>	1/2" x CL Black Welded Nipple	EA	25
<b>BPN-2</b>	1/2" x 1-1/2" Black Welded Nipple	EA	25
<b>BPN-3</b>	1/2" x 2" Black Welded Nipple	EA	25
<b>BPN-4</b>	1/2" x 2-1/2" Black Welded Nipple	EA	25
<b>BPN-5</b>	1/2" x 3" Black Welded Nipple	EA	25
<b>BPN-6</b>	1/2" x 3-1/2" Black Welded Nipple	EA	25
<b>BPN-7</b>	1/2" x 4" Black Welded Nipple	EA	25
<b>BPN-8</b>	1/2" x 4-1/2" Black Welded Nipple	EA	25
<b>BPN-9</b>	1/2" x 5" Black Welded Nipple	EA	25
<b>BPN-10</b>	1/2" x 5-1/2" Black Welded Nipple	EA	25
<b>BPN-11</b>	1/2" x 6" Black Welded Nipple	EA	25
<b>BPN-12</b>	1/2" x 7" Black Welded Nipple	EA	25
<b>BPN-13</b>	1/2" x 8" Black Welded Nipple	EA	25
<b>BPN-14</b>	1/2" x 9" Black Welded Nipple	EA	25
<b>BPN-15</b>	1/2" x 10" Black Welded Nipple	EA	25
<b>BPN-16</b>	1/2" x 11" Black Welded Nipple	EA	25
<b>BPN-17</b>	1/2" x 12" Black Welded Nipple	EA	25
<b>BPN-18</b>	3/4" x CL Black Welded Nipple	EA	25
<b>BPN-19</b>	3/4" x 1-1/2" Black Welded Nipple	EA	25
<b>BPN-20</b>	3/4" x 2" Black Welded Nipple	EA	25
<b>BPN-21</b>	3/4" x 2-1/2" Black Welded Nipple	EA	25
<b>BPN-22</b>	3/4" x 3" Black Welded Nipple	EA	25
<b>BPN-23</b>	3/4" x 3-1/2" Black Welded Nipple	EA	25
<b>BPN-24</b>	3/4" x 4" Black Welded Nipple	EA	25
<b>BPN-25</b>	3/4" x 4-1/2" Black Welded Nipple	EA	25

**Black Steel Welded Nipples (cont'd)**

CATALOG NO.	DESCRIPTION	UOM	ORDER MULTIPLE
<b>BPN-26</b>	3/4" x 5" Black Welded Nipple	EA	25
<b>BPN-27</b>	3/4" x 5-1/2" Black Welded Nipple	EA	25
<b>BPN-28</b>	3/4" x 6" Black Welded Nipple	EA	25
<b>BPN-29</b>	3/4" x 7" Black Welded Nipple	EA	25
<b>BPN-30</b>	3/4" x 8" Black Welded Nipple	EA	25
<b>BPN-31</b>	3/4" x 9" Black Welded Nipple	EA	25
<b>BPN-32</b>	3/4" x 10" Black Welded Nipple	EA	25
<b>BPN-33</b>	3/4" x 11" Black Welded Nipple	EA	25
<b>BPN-34</b>	3/4" x 12" Black Welded Nipple	EA	25
<b>BPN-35</b>	1" x CL Black Welded Nipple	EA	25
<b>BPN-37</b>	1" x 2" Black Welded Nipple	EA	25
<b>BPN-38</b>	1" x 2-1/2" Black Welded Nipple	EA	25
<b>BPN-39</b>	1" x 3" Black Welded Nipple	EA	25
<b>BPN-40</b>	1" x 3-1/2" Black Welded Nipple	EA	25
<b>BPN-41</b>	1" x 4" Black Welded Nipple	EA	25
<b>BPN-42</b>	1" x 4-1/2" Black Welded Nipple	EA	25
<b>BPN-43</b>	1" x 5" Black Welded Nipple	EA	25
<b>BPN-44</b>	1" x 5-1/2" Black Welded Nipple	EA	25
<b>BPN-45</b>	1" x 6" Black Welded Nipple	EA	25
<b>BPN-46</b>	1" x 7" Black Welded Nipple	EA	25
<b>BPN-47</b>	1" x 8" Black Welded Nipple	EA	25
<b>BPN-48</b>	1" x 9" Black Welded Nipple	EA	25
<b>BPN-49</b>	1" x 10" Black Welded Nipple	EA	25
<b>BPN-50</b>	1" x 11" Black Welded Nipple	EA	25
<b>BPN-51</b>	1" x 12" Black Welded Nipple	EA	25
<b>BPN-52</b>	1/2" x 18" Black Welded Nipple	EA	5
<b>BPN-53</b>	1/2" x 24" Black Welded Nipple	EA	5
<b>BPN-54</b>	1/2" x 36" Black Welded Nipple	EA	5
<b>BPN-A12</b>	1/2" Assortment Pack, 6 each of CL thru 6", pack of 66	PK	1
<b>BPN-A34</b>	3/4" Assortment Pack, 6 each of CL thru 6", pack of 66	PK	1
<b>BPN-A1</b>	1" Assortment Pack, 6 each of CL thru 6", pack of 66	PK	1

**MALLEABLE BLACK IRON PIPE FITTINGS**

**90 Degree Ell**

- Material: ASTM A 197 Cupola Malleable Iron, 150 lb.
- Dimensions:  
ANSI B 16.3 - Malleable Iron Threaded Fittings  
ANSI B 16.14 - Ferrous Pipe Plugs, Bushings etc.  
ANSI B 16.39 - Malleable Iron Threaded Pipe Unions
- Threads: ANSI B 2.1 or BS 21
- Tensile Strength: 28.4 kg/mm.min



CATALOG NO.	DESCRIPTION	UOM	ORDER MULTIPLE
<b>BPF-01</b>	1/2" 90 Degree Elbow	EA	50
<b>BPF-02</b>	3/4" 90 Degree Elbow	EA	35
<b>BPF-03</b>	1" 90 Degree Elbow	EA	20

**45 Degree Ell**

The 45 Degree Ell fitting is made of ASTM A 197 Cupola Malleable Iron, 150 LB. The dimensions for this fitting are ANSI B 16.3. The threads are ANSI V 2.1 or BS 21 and the tensile strength is 28.4 kg/mm.min for this fitting.



CATALOG NO.	DESCRIPTION	UOM	ORDER MULTIPLE
<b>BPF-04</b>	1/2" 45 Degree Elbow	EA	50
<b>BPF-05</b>	3/4" 45 Degree Elbow	EA	40
<b>BPF-06</b>	1" 45 Degree Elbow	EA	20

**MALLEABLE BLACK IRON PIPE FITTINGS cont'd**

**Coupling**

The Coupling fitting is made of ASTM A 197 Cupola Malleable Iron, 150 LB. The dimensions for this fitting are ANSI B 16.3. The threads are ANSI V 2.1 or BS 21 and the tensile strength is 28.4 kg/mm.min for this fitting.



CATALOG NO.	DESCRIPTION	UOM	ORDER MULTIPLE
<b>BPF-07</b>	1/2" Coupling	EA	60
<b>BPF-08</b>	3/4" Coupling	EA	50
<b>BPF-09</b>	1" Coupling	EA	25

**90 Degree Street Ell**

The 90 Degree Street Ell fitting is made of ASTM A 197 Cupola Malleable Iron, 150 LB. The dimensions for this fitting are ANSI B 16.3. The threads are ANSI V 2.1 or BS 21 and the tensile strength is 28.4 kg/mm.min for this fitting.



CATALOG NO.	DESCRIPTION	UOM	ORDER MULTIPLE
<b>BPF-13</b>	1/2" 90 Degree Street Elbow	EA	60
<b>BPF-14</b>	3/4" 90 Degree Street Elbow	EA	35
<b>BPF-15</b>	1" 90 Degree Street Elbow	EA	30

**Reducing Tee**

The Reducing Tee fitting is made of ASTM A 197 Cupola Malleable Iron, 150 LB. The dimensions for this fitting are ANSI B 16.3. The threads are ANSI V 2.1 or BS 21 and the tensile strength is 28.4 kg/mm.min for this fitting.



CATALOG NO.	DESCRIPTION	UOM	ORDER MULTIPLE
<b>BPF-19</b>	1/2" x 1/2" x 3/4" Reducing Tee	EA	45
<b>BPF-20</b>	3/4" x 1/2" x 1/2" Reducing Tee	EA	45
<b>BPF-21</b>	3/4" x 1/2" x 3/4" Reducing Tee	EA	45
<b>BPF-34</b>	1" x 1" x 1/2" Reducing Tee	EA	50

**Cap**

The Cap fitting is made of ASTM A 197 Cupola Malleable Iron, 150 LB. The dimensions for this fitting are ANSI B 16.3. The threads are ANSI V 2.1 or BS 21 and the tensile strength is 28.4 kg/mm.min for this fitting.



CATALOG NO.	DESCRIPTION	UOM	ORDER MULTIPLE
<b>BPF-25</b>	1/2" Cap	EA	75
<b>BPF-26</b>	3/4" Cap	EA	40
<b>BPF-27</b>	1" Cap	EA	35

**Union**

The Union fitting is made of ASTM A 197 Cupola Malleable Iron, 150 LB. The dimensions for this fitting are ANSI B 16.39. The threads are ANSI V 2.1 or BS 21 and the tensile strength is 28.4 kg/mm.min for this fitting.



CATALOG NO.	DESCRIPTION	UOM	ORDER MULTIPLE
<b>BPF-31</b>	1/2" Union	EA	25
<b>BPF-32</b>	3/4" Union	EA	20
<b>BPF-33</b>	1" Union	EA	15

**Reducing Coupling**

The Reducing Coupling fitting is made of ASTM A 197 Cupola Malleable Iron, 150 LB. The dimensions for this fitting are ANSI B 16.3. The threads are ANSI V 2.1 or BS 21 and the tensile strength is 28.4 kg/mm.min for this fitting.



CATALOG NO.	DESCRIPTION	UOM	ORDER MULTIPLE
<b>BPF-10</b>	3/4" x 1/2" Reducing Coupling	EA	60
<b>BPF-11</b>	1" x 1/2" Reducing Coupling	EA	30
<b>BPF-12</b>	1" x 3/4" Reducing Coupling	EA	30

**Tee**

The Tee fitting is made of ASTM A 197 Cupola Malleable Iron, 150 LB. The dimensions for this fitting are ANSI B 16.3. The threads are ANSI V 2.1 or BS 21 and the tensile strength is 28.4 kg/mm.min for this fitting.



CATALOG NO.	DESCRIPTION	UOM	ORDER MULTIPLE
<b>BPF-16</b>	1/2" Tee	EA	40
<b>BPF-17</b>	3/4" Tee	EA	35
<b>BPF-18</b>	1" Tee	EA	20

**Bushing**

The Bushing fitting is made of ASTM A 197 Cupola Malleable Iron, 150 LB. The dimensions for this fitting are ANSI B 16.14. The threads are ANSI V 2.1 or BS 21 and the tensile strength is 28.4 kg/mm.min for this fitting.



CATALOG NO.	DESCRIPTION	UOM	ORDER MULTIPLE
<b>BPF-22</b>	3/4" x 1/2" Hex Bushing	EA	50
<b>BPF-23</b>	1" x 1/2" Hex Bushing	EA	50
<b>BPF-24</b>	1" x 3/4" Hex Bushing	EA	50

**Plug**

The Plug fitting is made of ASTM A 197 Cupola Malleable Iron, 150 LB. The dimensions for this fitting are ANSI B 16.14. The threads are ANSI V 2.1 or BS 21 and the tensile strength is 28.4 kg/mm.min for this fitting.



CATALOG NO.	DESCRIPTION	UOM	ORDER MULTIPLE
<b>BPF-28</b>	1/2" Plug	EA	25
<b>BPF-29</b>	3/4" Plug	EA	15
<b>BPF-30</b>	1" Plug	EA	20

# CONDENSATE MANAGEMENT

ClearVue™ Tubes & Traps.....	68
Condensate Drain Line Cleaning .....	68-69
Condensate Drain Line Switches .....	67
Condensate Drain Pans, Fittings, Adapters.....	69-70
Condensate Pumps.....	66
Drain Line, Tubing .....	71
Tapes .....	71

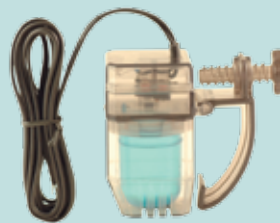
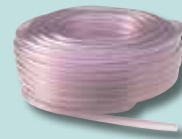

# ClearVue™ Pump

## About ClearVue™

The new ClearVue™ condensate pump from DiversiTech is unlike any other pump available. ClearVue™ features Variable Speed and Lift which makes ClearVue™ the smartest condensate pump on the market. Variable Speed and Lift provides ClearVue™ the ability to “think” and adapt to changing conditions. It’s not just off or on like a regular pump. ClearVue™ senses the amount of condensate water in the tank and its rate of inflow and adjusts its speed and lift to match the conditions and keep the tank clear. ClearVue™ starts pumping slowly and only accelerates if needed. And since it pumps slowly, ClearVue™ is super quiet and easy to live with.

With its Floatless Sensor™ technology, ClearVue™ doesn’t have the usual problems associated with float switch pumps. No more stuck floats or misaligned contacts to cause problems and potential damage. ClearVue™ uses Floatless Sensor™ technology to detect the condensate level in the tank and make the right decision about what to do next. ClearVue™ pump also features a see-through tank to give the contractor and homeowner a clear view of water, blockage, and buildup in the tank. This clear tank allows for quick troubleshooting due to normal buildup caused by daily condensate generation. ClearVue™ gives you the most improved, user-inspired features on the market.

## What makes ClearVue™ Better?

- The ClearVue™ pump features Variable Speed and Lift which allows ClearVue™ to change pump speed and lift based on condensate flow. Other pumps are simply off or on but ClearVue™ starts pumping slowly, then gradually accelerates its lift if needed.
- Floatless Sensor™ technology means more reliable operation and no problems from stuck or fouled mechanical floats. ClearVue’s Floatless Sensor™ detects the condensate level without a float for reliable, accurate operation. **No float, no problems.**
- World’s only self-cleaning condensate pump. ClearVue™ features a unique self-cleaning mode to maintain itself and help keep drain lines clear. Also, if ClearVue™ senses a blockage, it will begin self-cleaning and pulse the condensate water to try to remove the blockage.
- ClearVue™ also offers a clear tank that allows the user to see what’s happening inside. This means faster and more accurate troubleshooting.



**FLOATLESS  
SENSOR™**

**DIVERSITECH**



## ClearVue™ PUMP™

**0-22'**  
Variable Speed  
and Lift  
Self-Cleaning



Stainless Steel  
Mounting Tabs

Reversible  
Deck

Clear Tank

**FLOATLESS  
SENSOR™**

Silicone  
Rubber Feet

## NO FLOAT, NO PROBLEMS



### Floatless Sensor™ Technology

ClearVue's sensors tell it how high the water is in the tank and how fast the inflow is. It then adjusts pump speed and lift to keep the tank clear and the system running properly. *No float, no problems.*



### Molded Silicone Rubber Feet

Specially designed rubber feet dampen vibration and noise, making ClearVue™ quiet and easy to live with. And like the feet on all DiversiTech pumps, they are installed at the factory and stay in place.



### Push Button Drain

Need to drain the tank quickly? Simply push the DRAIN button and ClearVue™ removes all the water in the tank—fast.



### Stainless Steel Hang Tabs

Two stainless steel hanging tabs offer many installation options. The tabs are sturdy and durable and will last longer than standard plastic mounts.



### Clear Tank

ClearVue™ also offers a clear tank so you can easily see what's happening inside the tank. The clear tank makes it easy to see the water level and diagnose other issues if needed.



### LED Indicator Lights

4 LED indicator lights – Ready, Pumping, Cleaning, and Alarm. LED lights tell you what mode the pump is in at any given time.



### Check Valve

Removable duckbill check valve resists corrosion and wear and is self-cleaning.

# ClearVue™ Mini Pump

*ClearVue™ Mini is the newest innovation in Ductless System pumps from DiversiTech. It's small, quiet and offers a host of unique features that help it outperform other mini-split pumps. And just like the original ClearVue™ and ClearVueKube™ pumps, ClearVue™ Mini features Variable Speed and Lift and Floatless Sensor™ technology that help the pump think and respond to changing conditions.*



Look at everything ClearVue™ Mini offers:

## NO FLOAT, NO PROBLEMS



### Variable Speed and Lift

ClearVue™ Mini determines how fast condensate is entering the tank and adjusts its speed and lift to match the conditions and keep the tank clear.



### Aluminum Pump Housing

ClearVue™ Mini features an aluminum housing that is built to last. This tough housing protects the pump from physical damage and helps contribute to the super quiet operation of the pump.



### Floatless Sensor™ Technology

*No float, no problem!* That's what ClearVue™ Mini's Floatless Sensor™ will provide you and your customers. ClearVue™ Mini's Floatless Sensor™ eliminates many of the typical problems associated with conventional condensate pumps. By eliminating the float, ClearVue™ Mini won't fail like conventional float-switch pumps.



### Rubber Mounting Pad

The molded rubber mounting pad can be used to mount ClearVue™ Mini to a vertical or horizontal surface; or to copper refrigerant lines with cable ties. The rubber pad decreases sound and vibration, contributing to a very quiet pump.

ClearVue™ Mini uses Floatless Sensor™ technology in different levels in the tank to provide the most accurate water level information to the pump's brain. And better information means a better pump. ClearVue's Floatless Sensor™ technology tells it how high the water is in the tank and how fast the inflow is. ClearVue™ Mini then uses this information to adjust its pump speed and lift to keep the tank clear and the system running properly.

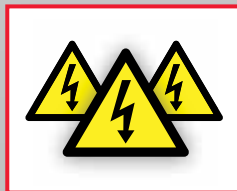

### Multiple Voltages

ClearVue™ Mini can be powered with any voltage from 120 to 240V, 50 or 60 Hz. With one product suitable for multiple voltages, there is no need to stock separate SKUs for different voltages.



### Super Quiet

With Variable Speed and Lift ClearVue™ Mini is nearly inaudible. You literally can hardly hear the pump run. This quiet operation allows maximum installation flexibility, as you can place the pump right in the room where people are.



### LED Lights

ClearVue™ Mini features three LED indicator lights: Ready, Pumping, and Alarm. The LED lights tell you what mode the pump is in at any given time.

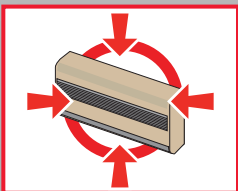

### Flexible Installation

ClearVue™ Mini is compact — only 3-1/2" x 2" x 3". It fits almost anywhere including inside a line set cover, inside the wall cassette unit (on some cassette models), and easily installs in the ceiling or behind a wall. ClearVue™ Mini features suction lift of up to 6.5'.



### Separate Tank

ClearVue™ Mini features a separate tank that can be located away from pump if needed, providing a more flexible installation. This small tank fits inside most indoor cassettes.



### Built-in Overflow Switch

ClearVue™ Mini also include a built-in overflow switch that shuts down the compressor in case of clogged line. This prevents damage to equipment or the environment.



### 2 Year Warranty

ClearVue Mini includes an extended 2 year warranty.

QUICK, EASY INSTALLATION
HIGHEST LIFT: 22FT.
SAFETY SWITCH
AVAILABLE WITH TUBING
LOW PROFILE MODELS AVAILABLE

SAVE INSTALLATION TIME WITH

# CP-22 CONDENSATE PUMPS



# DiversiTech Condensate Pumps



**Metal Hang Tabs**

Shatterproof metal hang tabs have hole-and-slot design for easy mounting. Tabs are located on convenient 8" centers.



**Indicator Lights**

Red, yellow, and green indicator lights show the pump status. Green for power applied, yellow for pump running, and red for high level alarm.



**Overflow Safety Switch**

1/4" quick connect terminals provide easy connection to the built-in overflow switch. Two terminals are provided allowing the installer flexibility to connect air handler shut-down. Switch features SPDT isolated contacts ready for connection to building automation systems.



**Four Inlet Holes**

Four inlets versus two or three on other pumps provide the greatest installation versatility. Inlet holes have a reinforced wall for durability.



**Rubber Feet**

Rubber feet dampen vibration which reduces noise.



**Check Valve**

Removable check valve for easy cleaning.



**Vibration Isolation**

An elastomeric motor mounting gasket dampens vibration.

# High Rise Pan™

The High Rise Pan™ is an innovative new plastic drain pan design which allows placement of an air handler 2-3/4" above the outside lip of the pan without the need for separate, cumbersome mounting blocks. The pan has a molded-in network of risers to give a 5" lift. The risers are positioned to accept a wide variety of air handler sizes. Each riser has a specially shaped area at each end to accommodate a 2" x 2" anti-vibration pad which allows for quiet operation at all times.

Other features include heavy duty reinforcement throughout to give plenty of support as well as rolled edges for durability. One-piece plastic construction ensures no rust, leaks, or seams to split.

Each High Rise Pan™ comes complete with a Condensate Cop™ float switch, six E.V.A. anti-vibration pads, and one 3/4" PVC male adapter. Installation is straightforward and hassle-free.

*Water pushes to the side of the pan preventing stagnant water from building up in inaccessible areas. This helps prevent slime and algae accumulations, eliminating call backs due to foul smells.*

**Now available in a Single Pack box, too!**

**Nestable! High Rise Pans™ take up less space.**

*Diversitech High Rise Pans™ are nestable, thus creating a tremendous decrease in volume needed to store and transport the pans.*

**FEATURE**

**BENEFIT**

**Nestable**

Because DiversiTech High Rise Pans™ are nestable, there is a tremendous decrease in volume needed to store and transport the pans.



**Eliminates a single line vendor**

Eliminating a vendor cuts distributor costs and saves warehouse and transportation costs.

**Water pushes to the side of the pan**

This prevents stagnant water in inaccessible areas which helps prevent slime and algae buildup, eliminating call backs because of smell.

**Includes EVA™ pads**

EVA™ pads increase the overall height of the unit which increases available drain line pitch. EVA™ pads also create better sound and vibration dampening for a quieter installation, meaning less call backs due to noise.

**Standard anti-vibration pad**

Uses a standard, easily available anti-vibration pad, eliminating the need to stock extra SKUs of anti-vibration pads. Competitor products use specialized grommets which are not commonly available.



**Installation kit includes six EVA™ pads and Condensate Cop™ float switch**

The universal CC-1 can be placed anywhere on the pan. It can also be used on other secondary drain pans (metal or plastic). You will never forget a part because you have a complete kit!

**80% thicker than the standard drain pan**

Stronger and more durable for job site installations; resists work place installation damage, minimizing the need to replace drain pans damaged at job site.



**ABS construction/flexible material**

Time-tested material has been used for 15 years in the market. Flexibility allows for easier fit in tight work places and a faster installation. You'll have peace of mind for long term performance.

**Heat/cold resistance**

Meets structural and temperature requirements for attic installations.

**5" riser**

5" riser gives additional height needed to assure proper drain line pitch. Stack EVA™ pads for additional height.

**Heavy-duty reinforced construction**

Gives support for a wider range of air handler applications, minimizing the need to replace drain pans damaged at the job site.



# Metal Drain Pan

*Diversitech introduces the ultimate in drain pan design - the seamless, nestable, metal drain pan with rolled edges.*





## FEATURES

## BENEFITS

### Seamless

The seamless design of DiversiTech metal drain pans virtually eliminates leaks from seams and folded corners found in conventional metal drain pans.

### Nestable

Because DiversiTech drain pans are nestable, there is a tremendous decrease in volume needed to store and transport metal drain pans. A stack of seventy DiversiTech metal drain pans is only 12" high. Therefore, seventy DiversiTech pans fit in the same space as six conventional 2" deep non-nesting drain pans!

### Single Piece Design

The DiversiTech metal drain pan is stamped from a single sheet of 26 gauge galvanized steel which prevents leaks.

### Rolled Edge

The rolled edge virtually eliminates hand injuries during handling.

### Two Outlets

Easy, flexible installation with an outlet on both the long and short side of the pan — no need to cut an outlet if you have the wrong pan on the job.

### Fittings Included

Get everything you need for the installation of the pan in a single package. Fittings are included with DiversiTech metal drain pans.



A stack of  
70 DiversiTech  
metal drain pans  
is only  
12" high!

*70 DiversiTech drain pans fit in the same space as 6 conventional 2" deep non-nesting drain pans!*

# Safety Overflow Switch (SOS™)

## What is the Safety Overflow Switch (SOS™)?

**D**esigned for use on 3/4" PVC condensate drain line, the SOS snaps easily over existing drain line tubing and can be glued in place using PVC cement.

The SOS electronically senses water near the inside wall of the PVC drain tubing. By locating the SOS with its body away from the normal flow, it can detect a possible overflow condition when the PVC drain line becomes full with water. Like a culvert, a condensate drain line is normally mostly empty with a small amount of water flowing in the lower parts of the horizontal run. Since the SOS's sensor component only covers part of the tubing, a low volume of flowing water does not activate the switch. The pipe must be full or near full to activate the switch. The SOS can be mounted horizontally, vertically, or at any angle.

The SOS works with 24 VAC control circuits and typical contactors. When not detecting water, it is normally closed and allows normal air conditioner operation. When water nears the SOS's sensor, the switch triggers and the control circuit is opened. Then, the LED indicator lights to show that there may be system trouble.

*Furnished complete with switch, 5' (1.5 meter) 18 AWG, 2 wire lead, and a 3/4" PVC male fitting adapter for direct coupling to a primary pan drain line connection.*



- SOS electronically senses water in the PVC drain tubing.
- SOS is designed for use on 3/4" PVC condensate drain line.
- SOS snaps easily over existing drain line tubing.





**Faster Install**

**Hinged Fast Lock Clamp**

Hinged clamp bar self adjusts to angle of pan wall for a level switch. One-step installation with single screw fastener. Single screw fastens switch to pan – no drilling and no fussing with multiple thumb screws.



**Works Everywhere**

**Universal Pan Mount**

Easy twist to adjust to pan walls of 0, 8, 15 or 22 degrees. Fast, simple, easy, and level installation on metal or plastic pans for reliable moisture detection. Angled installation on other switches reduces their ability to detect condensate overflow.

# CS1200 AC Shutoff Switch

The CS1200 Multi-Position AC Shutoff Switch from DiversiTech is a reliable, easy to use float switch that clips on to any pan size. Designed with contractor feedback in mind, the CS1200 features an adjustable housing that twists to match any pan angle for easy installation. The CS1200 detects water in the pan quickly and shuts off the equipment to prevent damage. The CS1200 also includes these great features:

- Hinged fast lock clamp
- LED Indicator light
- Universal pan mount
- Large water openings for fast detection
- Push to test button
- Simple 2 wire installation
- 5 AMP switching, 24 Volt



**LED Indicator Light**

Easy to see visual trip indicator alarm displays red if switch is tripped. CS1200 is the only pan switch with a light for fast troubleshooting.



**Push to Test**

Know instantly with the push of a button that your switch is installed and functioning properly. The bright LED indicator visually confirms proper operation.



**Reliable Mechanical Contact Float Switch**

Trouble free design reduces overflow failures and call backs. All electronics are mounted above the waterline, eliminating the chance of malfunction. The one piece molded float protects switch from water and debris. This is the same design used for safety interlocks because it gives you years of reliable, maintenance free service.



**10x Open Area**

10 times more open area for water to enter the detection chamber with our large open area design. No detection failure from small holes that can get clogged. Prevents switch failure from clogged water holes. No call backs due to clogged switches.



**Simple 2 Wire Installation**

With a simple 2 wire connection, the CS1200 is simple, easy, and fast to install. No checking polarity, just connect the switch in the red or yellow wire. Simple well designed electrical connections using 6 feet of the standard 18AWG wire and high current (5 amp) switching. The CS1200 gives you everything you need in one simple switch.



**Clear Design**

CS1200 is the only pan switch with a clear design for fast troubleshooting. Clear design lets you see the float and switch. Know instantly that the switch is working and components are functioning.

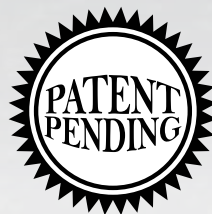

RECOGNIZED COMPONENT



Intertek

# Wet Switch Flood Detector

## WHAT IS THE WET SWITCH?

**T**he Wet Switch is a solid state device designed to detect the presence of condensate water overflow. The Wet Switch is placed into the secondary drain pan — a normally dry pan. If the primary drain pan fails, condensate water will overflow into the secondary drain pan. Upon sensing moisture, the Wet Switch will turn the system off (typically the cause of the condensing water) to help prevent damage to carpets, walls, woodwork, ceilings, and other property.

- Hydrophilic Pad
- Integral Feet
- Stainless Steel Sensor Array
- Solid State Electronics
- Epoxy Encapsulated Electronics
- Double Throw Relay
- Standard 24VAC control
- Multiple Unit Connectivity

The Wet Switch is designed to interrupt the operation of cooling systems. However, it is a water activated switch and can be used in a variety of other applications.

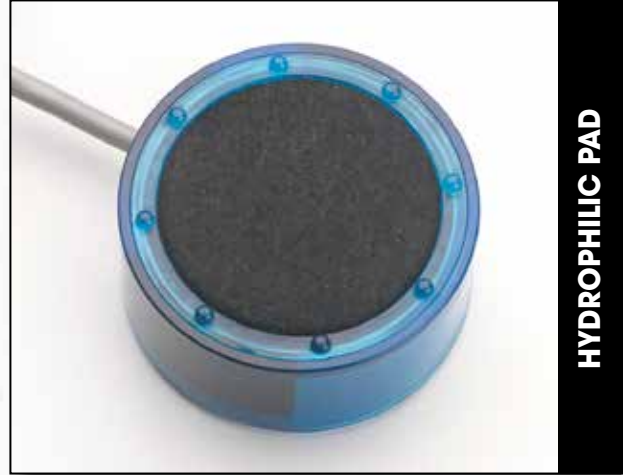

HYDROPHILIC PAD

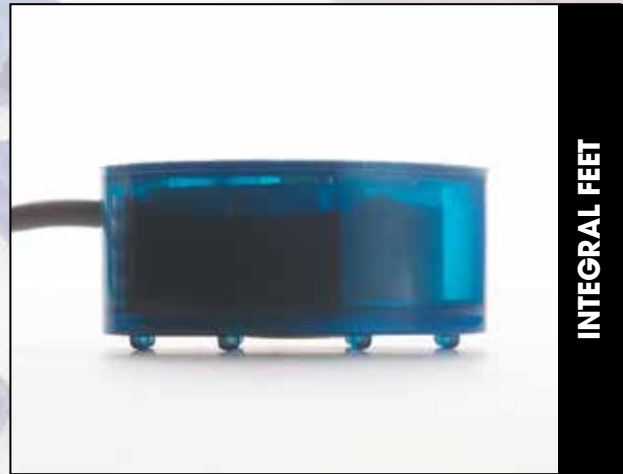

INTEGRAL FEET



STAINLESS STEEL SENSORS

## HYDROPHILIC PAD

A high tech polymeric fiber quickly draws water into the sensor array using proven capillary technology.

## INTEGRAL FEET

Integral feet raise the hydrophilic pad and sensor array off the drain pan slightly to prevent nuisance tripping and pan corrosion (metal pans only) from interfering with the sensor array.

## STAINLESS STEEL SENSOR ARRAY

A high tech array of multiple stainless steel sensors detects even a minimal amount of water drawn into the hydrophilic pad.

## COMPACT PACKAGE

This technology is packed into a 3-5/8" diameter by 1-1/4" high cylinder. Furnished complete with 5-conductor 22AWG stranded cable, 6' long.

## DOUBLE THROW RELAY

Allows for wiring to interrupt system and to sound an alarm (by others) when moisture is detected.

## SOLID STATE ELECTRONICS

Proven electronics prevent mechanical failure in an aggressive operating environment.

## MULTIPLE UNIT CONNECTIVITY

Multiple unit connectivity allows for multiple Wet Switches to be connected in series to adequately cover large drain pan areas.

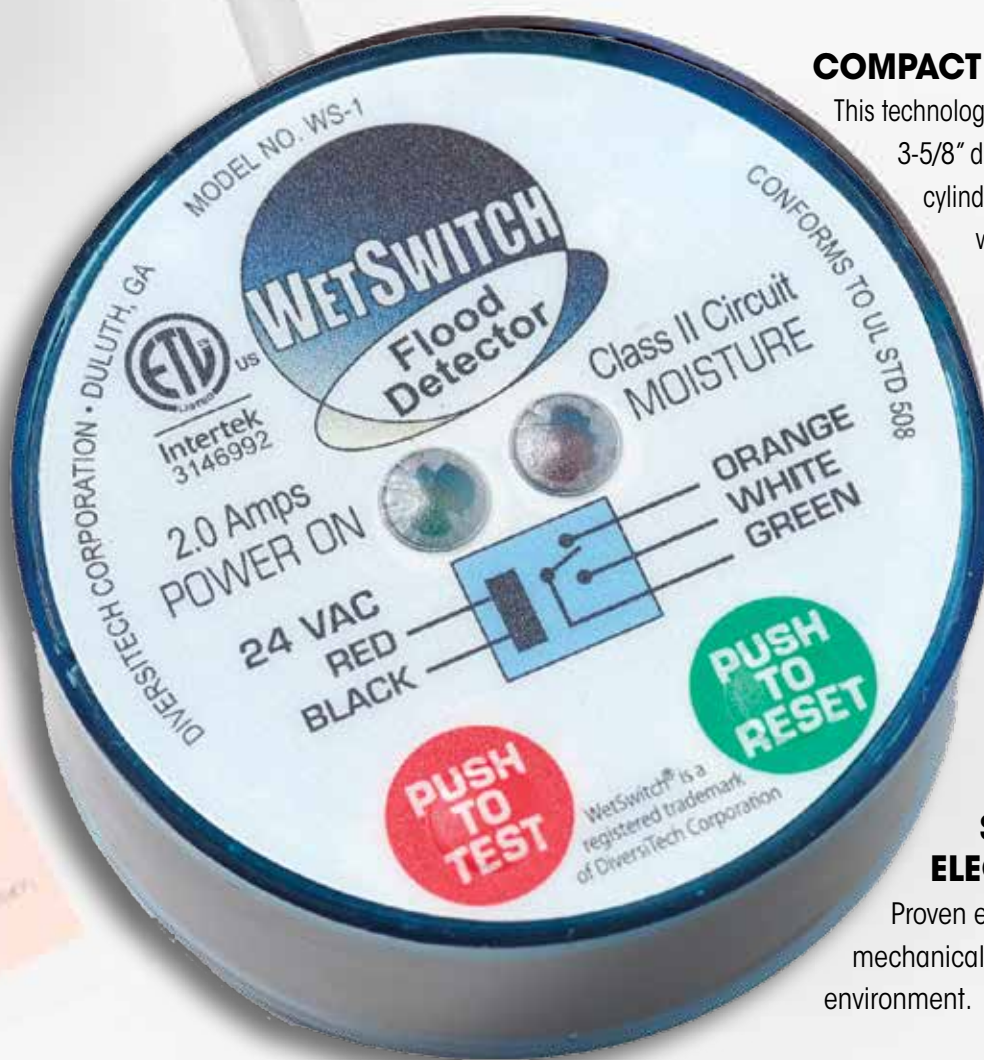

# Drain Gun - Charles Gallo Brand



**T**he Drain Gun - Charles Gallo Brand is a lightweight (3oz.) portable tool designed to blow out condensate drain lines instantly. Simply insert a Swoosh CO<sub>2</sub> cartridge into the Charles Gallo Drain Gun and with a press of the trigger — SWOOSH — 800 psi of oil free air clears the line.

## INSTRUCTIONS:

- Unscrew cup and insert cartridge with the narrow end up.
- Without depressing the trigger, screw the cup slowly into the head until the cartridge contacts the puncture pin.
- Quickly and firmly screw the unit together to puncture and seal the cartridge in the same motion.

Note: Not completely screwing the unit together may result in escaping gas.

- Release the red safety catch.
- Depress the trigger to discharge the Swoosh CO<sub>2</sub> cartridge. For condensate drains, a quick and full discharge is best.

*The Drain Gun - Charles Gallo Brand is for use with condensate drain and oil burner lines only.*





**SMALL AND LIGHTWEIGHT**  
The Drain Gun packs cleaning power into a small, lightweight package. This prevents the need for carrying heavy air or nitrogen tanks.



**AIR POWER**  
The Drain Gun uses CO<sub>2</sub>, eliminating the mess caused by water back flushing drain lines.

**ENVIRONMENTALLY FRIENDLY**  
The Drain Gun uses carbon dioxide (CO<sub>2</sub>), a common component of air, and is totally safe for use in the environment. The Drain Gun is an excellent alternative to the environmentally unfriendly practice of using refrigerant to clean the drain line.

**FLEXIBLE HOSE ASSEMBLY**  
The flexible hose assembly enables you to maneuver through cabinets, coils, and hard to reach drains.

**ADAPTER KIT**  
An adapter kit is available to allow for use on oil burner lines and tighter areas with a 90° fitting.

*Fittings increase the versatility of the innovative Drain Gun and are available from your distributor.*



# Condensate Drain Line Cleaners

DiversiTech offers a family of products designed to help make condensate drain line cleaning faster and easier. From the super lightweight handheld Charles Gallo Drain Gun to the full power of the DrainDawg, DiversiTech has the right solution for every need. These products also have multiple other uses including operating air power tools, purging and testing copper tubing and more.



## HANDHELD POWER

- Clears condensate drain lines with a SWOOSH!
- Lightweight and portable - goes anywhere
- Environmentally friendly
- Uses CO<sub>2</sub> refill cartridges



## PORTABLE POWER

- Uses Nitrogen or CO<sub>2</sub>
- Lightweight and portable
- Includes boxed fitting kit
- Easy to refill at your truck
- Multiple uses
- Includes inflatable DrainDawg fitting to clear lines fast



## ULTIMATE POWER

- Uses Nitrogen or CO<sub>2</sub>
- Includes 10' flexible hose and blowgun assembly
- Includes boxed fitting kit
- Multiple uses
- Includes inflatable DrainDawg fitting to clear lines fast



**CONDENSATE PUMPS**

**ClearVue™ Pump**

No Float, No Problems! ClearVue's Variable Speed and Lift and Floatless Sensor™ make this the most advanced condensate pump ever. This new pump can provide up to 22' of lift if needed. ClearVue™ runs at the minimum speed needed, saving wear on the pump. The pump selects the lowest effective speed, making it quieter than a regular pump. Its unique self cleaning feature senses problems and automatically enters a self cleaning mode using condensate water to fix the issue. The ClearVue™ pump features a clear bottom tank to easily check the water level. Other features include: stainless steel mounting tabs, silicone rubber feet, reversible deck, four inlet holes, and LED indicator lights. ETL Listed File Number 3190890



**IQP-120**

CATALOG NO.	DESCRIPTION	UOM	ORDER MULTIPLE
<b>IQP-120</b>	ClearVue™ Pump – 120V – 0-22' Lift	EA	6
<b>IQP-120T</b>	ClearVue™ Pump w/Tube – 120V – 0-22' Lift	EA	6

**ClearVue™ Mini Ductless System Pump**

Featuring super quiet operation, specifically designed for ductless system installations, and including Variable Speed and Lift and Floatless Sensor™, ClearVue™ Mini is chock full of innovative features, and priced competitively.



**CVMINI**

CATALOG NO.	DESCRIPTION	UOM	ORDER MULTIPLE
<b>CVMINI</b>	ClearVue Mini - Ductless System Pump	EA	6

**ClearVueKübe™**

ClearVueKübe™ Pump condensate pump is the answer for ductless systems. Featuring a whisper quiet motor and small footprint, it is the ideal solution for handling condensate issues. The Kübe is designed for mini split systems and includes a host of innovative features, all packed into a super quiet, super small pump that fits almost anywhere. ClearVueKübe™ is also available with a shroud cover set.



**IQP-KUBE**

CATALOG NO.	DESCRIPTION	UOM	ORDER MULTIPLE
<b>IQP-KUBE</b>	ClearVueKübe™ only	EA	6
<b>IQP-KUBE-SHROUD</b>	ClearVueKübe™ with shroud	EA	6

**Pump Parts & Accessories**

Check valve installs easily and prevents water from travelling backwards into the pump and overflowing.



**CP-CV**

CATALOG NO.	DESCRIPTION	UOM	ORDER MULTIPLE
<b>CP-CV</b>	Replacement Check Valve for CP-22	EA	1
<b>CP-CVCF</b>	Replacement Check Valve – 3/8" compression fitting	EA	1

**CP-22 Pumps**

Suitable for use with condensate from high efficiency condensing furnaces and boilers which produce acidic condensate. 22' of lift compared to the typical 20'. Features include vibration dampening feet and motor mounts, metal hang tabs, four inlet holes, a clear indicator display, a float switch and check valve. Integrating the CP-22 into your system is easy. 1/4" quick connect terminals provide easy connection to the built in overflow switch. 2 terminals are provided allowing flexibility to connect air handler shut down. UL Listed File Numbers E253155 and E258186.



**CP-22**

CATALOG NO.	DESCRIPTION	UOM	ORDER MULTIPLE
<b>CP-22</b>	Condensate Pump – 120V	EA	6
<b>CP-22T</b>	Condensate Pump – 120V w/20' 3/8" Tube	EA	6
<b>CP-22-230</b>	Condensate Pump – 230V	EA	6
<b>CP-22-230T</b>	Condensate Pump – 230V w/20' 3/8" Tube	EA	6

**CP-22 Low Profile Pumps**

The new CP-22LP comes packed with all the same great features found in the CP-22, but now in a low profile package. This pump is only 4-3/8" tall so it's a good fit for those instances where space is at a premium. The shorter reservoir holds 1/3 gallon. Suitable for use with condensate up to 160 degree F. UL Listed File Numbers E253155 and E258186.



**CP-22LP**

CATALOG NO.	DESCRIPTION	UOM	ORDER MULTIPLE
<b>CP-22LP</b>	Condensate Pump – 120V – Low Profile	EA	6
<b>CP-22LP-230</b>	Condensate Pump – 230V – Low Profile	EA	6

**General Purpose Pumps**

The DiversiTech CP-16 condensate pump is an economical alternative that's based off of the proven CP-22 design. More compact than the CP-22, it's designed to lift to a maximum of 16 feet. The CP-16 shares many of the great features of the CP-22, including hang tabs, four inlet holes, float switch, overflow switch, and a check valve. UL Listed File Numbers E253155 and E258186.



**CP-16**

CATALOG NO.	DESCRIPTION	UOM	ORDER MULTIPLE
<b>CP-16</b>	Condensate Pump 16' Lift 120V	EA	6
<b>CP-16-230</b>	Condensate Pump 16' Lift 230V	EA	6

## CONDENSATE DRAIN LINE SWITCHES

### Condensate Cop™

Condensate Cop™ is a unique clamp on float switch intended for HVAC drain pan installation. The Condensate Cop™ features a large over clamping area that fits easily over the edge of all types of drain pans; including formed plastic and galvanized sheet metal. A separate float/probe assembly swivels to accommodate drain pans having sloped sides. The swivel action allows the installer to position the float switch for best operation and then clamp it into place. The probe features an inlet grill which prevents the float from being blocked or damaged by insulation or other debris. Sealed inside the probe is a magnetically actuated normally closed switch. The switch opens when rising water presents a potential flooding condition. Two wire connection for easy hook up to a thermostat "Y" (compressor) circuit. Provided complete with 5' (1.5 meter) leads, wire nuts, and clamping screws. Small size, 24V/1.5 amp NC reed switch. ETL Listed File Number 3166285. UL508 Approved.

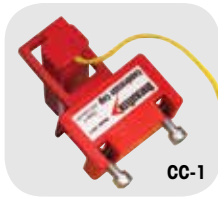

CATALOG NO.	DESCRIPTION	UOM	ORDER MULTIPLE
CC-1	Condensate Cop™ Drain Pan Switch	EA	12

### Safety Overflow Switch (SOS)

Designed for use on 3/4in. PVC condensate drain line. Snaps easily over existing drain line tubing and can be glued in place using PVC cement. The SOS electronically senses water near the inside wall of the PVC drain tubing. By locating the SOS with its body away from the normal flow, it can be used to detect a possible overflow condition when the PVC drain line becomes full with water. Like a culvert, the condensate drain line is normally mostly empty with a small amount of water flowing in the lower parts of the horizontal run. Since the sensor component of the SOS only covers part of the tubing, a low volume of flowing water does not activate the switch. The pipe must be full or near full to activate the switch. Mount SOS horizontally, vertically, or at any angle. Works with 24 VAC control circuits and typical contactors. When not detecting water, the SOS is normally closed and allows normal air conditioner operation. When water approaches the SOS's sensor, the switch triggers, and the control circuit is opened. The LED indicator lights to show that there may be system trouble, and the SOS is doing its job. Furnished complete with switch, 5' (1.5 meter) 18 AWG, 2 wire lead, and a 3/4 in. PVC male fitting adapter for direct coupling to a primary pan drain line connection. Now available with Push to Test button.



CATALOG NO.	DESCRIPTION	UOM	ORDER MULTIPLE
SOS-1	Safety Overflow Switch	EA	1

Patents pending.

### CS1200 AC Shutoff Switch

The CS1200 is a fast installing, reliable, condensate overflow detection switch. Featuring a unique universal pan mount design to assure accurate detection in metal or plastic secondary drain pans. UL508 Approved.



CATALOG NO.	DESCRIPTION	UOM	ORDER MULTIPLE
CS1200	CS1200 AC Shutoff Switch	EA	12

### Universal Alarm

A universal low voltage alarm that can indicate possible system trouble. Use with the Wet Switch, SOS, Condensate Cop, CP 22 (all types) and all float switches on 24VAC control circuits. If an alarm condition exists, the homeowner can turn the alarm off with a "silence" button until service is obtained, however a red trouble LED will remain lit. Also features: easy 2 wire connection, label to print contractor information, and low current draw. Actuates at greater than 18V to prevent any false alarms due to low voltage. Includes 2 wire nuts, a sheet metal screw, and double sided tape for convenient installation options. Also includes instructions for wiring normally open switch systems (for the CP 22 or other condensate pumps).



CATALOG NO.	DESCRIPTION	UOM	ORDER MULTIPLE
UA-1	Universal Alarm for 24VAC	EA	12

### Wet Switch Flood Detector

A solid state control designed to help prevent flooding, damage to carpets, walls, furniture, ceilings, etc. Now has a built in test and reset button for easier installation. Turns system off when detecting moisture due to condensate or drain leaks. One or two drops will cause Wet Switch to turn off a unit, alerting a serviceman to a moisture problem. A lit LED indicates the Wet Switch is activated and has turned the unit off. Reset simply by drying the absorbent pad with a paper towel and pressing the reset switch. Connects to 24 VAC. More than one unit may be connected to a system. 2 amp contact rating. Simple 5 wire installation. Sales displays available. ETL Listed File Number 3146992. UL508 Approved.



CATALOG NO.	DESCRIPTION	UOM	ORDER MULTIPLE
WS-1	Wet Switch Flood Detector	EA	1

### Pipe Mounted Switches

DiversiTech Flood Prevention Switches are simple to install, easy to service and extremely reliable. As water level in the auxiliary or main drain pipe rises due to a clogged air conditioning condensate drain, the switch shuts off the system - thus preventing water from overflowing and causing damage to doors, walls and ceilings. At the heart of the switch is a durable yet precise magnetic reed switch. Constructed of materials that will not rust or stick, the switch operates smoothly every time. UL508 Approved.



CATALOG NO.	DESCRIPTION	UOM	ORDER MULTIPLE
CS-1	Condensate Switch - Tee	EA	12
CS-2	Condensate Switch - Elbow	EA	12
CS-3	Condensate Switch - Clip	EA	12

**CLEARVUE™ TUBE & TRAPS**

**ClearVue™ Tube**

Clear, schedule 40 PVC ideal for installing as condensate drain lines in other areas where seeing the inside of the tubing is helpful. ClearVue™ Tube makes it easy to quickly spot build up or obstructions in drain lines for faster troubleshooting. Available in 5ft lengths.



CATALOG NO.	DESCRIPTION	UOM	ORDER MULTIPLE
<b>CV-TUBE</b>	ClearVue™ Tube – 5' section	EA	50

**ClearVue™ Traps**

DiversiTech introduces new ClearVue™ P and R traps. These traps are made from smooth, clear PVC with no flat spots to restrict flow. With these new ClearVue™ traps its easy to see directly into them to detect blockages and prevent problems before they become severe. Ideal for installation in condensate drain lines.

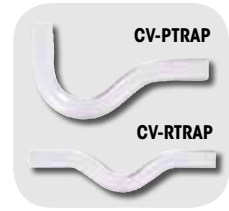

CATALOG NO.	DESCRIPTION	UOM	ORDER MULTIPLE
<b>CV-PTRAP</b>	ClearVue™ 3/4" P trap	EA	25
<b>CV-RTRAP</b>	ClearVue™ 3/4" R trap	EA	25

**CONDENSATE DRAIN LINE CLEANING**

**Flow-Plus™ Inline Cleaner**

Flow Plus™ Inline Cleaner installs in the 3/4in. condensate drain line to maintain clean condensate water and pump operation (if applicable). Unique design allows Flow Plus™ tablets to dissolve slowly, maintaining condensate flow for up to eight months. User replaceable tablet pack.



CATALOG NO.	DESCRIPTION	UOM	ORDER MULTIPLE
<b>IC-1</b>	Flow-Plus™ Inline Cleaner	EA	6
<b>IC-1R</b>	Flow-Plus™ Replacement Cartridge	EA	12

**Drain Gun™ - Charles Gallo Brand and SWOOSH CO<sub>2</sub> Cartridges**

Clears condensate drains with a SWOOSH! A lightweight (3 oz.) portable tool designed to blow out drain lines instantly. New larger SWOOSH CO<sub>2</sub> cartridges now deliver 800 PSI of oil free air to clear the line. Each unit comes equipped with a tapered fitting to work on 3/8in. – 3/4in. drain openings. Flexible hose assembly maneuvers through cabinets, coils and hard to reach drains. Cartridges are environmentally safe and recyclable. No need for air or nitrogen tanks. Reduces labor costs and time on service calls.



CATALOG NO.	DESCRIPTION	UOM	ORDER MULTIPLE
<b>GG-1</b>	Drain Gun for A/C Condensate Lines	EA	6
<b>GGC-12</b>	SWOOSH CO <sub>2</sub> Cartridges, pack of 12	PK	6
<b>GGC-6</b>	SWOOSH CO <sub>2</sub> Cartridges, pack of 6	PK	6
<b>GG-1A</b>	Drain Gun Adapter Kit	EA	1
<b>GG-1H</b>	Drain Gun Hose Assembly	EA	1
<b>GG-1TF</b>	Drain Gun replacement tip	EA	1
<b>GG-1BOR</b>	Drain Gun bottom o-ring, pack of 5	PK	1
<b>GG-1NHL</b>	Drain Gun body, no hose	EA	1

**DrainDawg™**

The DrainDawg™ is a complete condensate drain cleaning kit, including the CT-475M deluxe nitrogen / CO<sub>2</sub> 0-475 psi regulator, the TG-10 & BS-25 ten foot hose and blowgun assembly, and the CW-15 fifteen inch whip hose. Also included is the AP-DD DrainDawg™ Accessory Fitting Kit which contains the DF-75 DrainDawg™ inflatable tip, the CK-141 3/4"-1" cone fitting, the FA-02 CO<sub>2</sub> to nitrogen adapter, the QN-S3 needle tip, and the TC-25 tire chuck. Made in USA.



CATALOG NO.	DESCRIPTION	UOM	ORDER MULTIPLE
<b>CB-2</b>	DrainDawg kit	EA	3

**DrainKat™**

The DrainKat™ is an over the shoulder refillable, nitrogen or CO<sub>2</sub> mini drain cleaning kit. Featuring a small cylinder that holds 9 cubic feet of nitrogen or 2-1/2 pounds of CO<sub>2</sub>. The cylinder includes an integral mounted regulator for quick and easy adjustment of discharge pressure. Get exactly the amount of pressure you need with a quick adjustment on the regulator. Furnished complete with an 87" hose and drain gun kit, the CW-15 whip hose, and the AP-DK DrainKat™ Accessory Fitting Kit which contains the DF-75 DrainDawg™ inflatable tip, the CB-03 3/4"-1" cone fitting, the FA-01 male to male CO<sub>2</sub> to nitrogen adapter, the FA-03 CO<sub>2</sub> trans-fill adapter, and the the QN-S3 needle tip. Made in the USA.



CATALOG NO.	DESCRIPTION	UOM	ORDER MULTIPLE
<b>MBK-6</b>	DrainKat kit	EA	2

## CONDENSATE DRAIN LINE CLEANING cont'd

### Drain Dawg and Drain Kat™ Fittings

The Drain Dawg™ and Drain Kat™ products are compatible with a series of fittings to connect to condensate drain lines and hoses. The fittings are available individually, or as kits for the Drain Dawg™ and Drain Kat™.

CATALOG NO.	DESCRIPTION	UOM	ORDER MULTIPLE
AP-DD	Drain Dawg Accessory Pack	EA	1
AP-DK	Drain Kat Accessory Pack	EA	1
BS-25	Blow gun with safety tip for Drain Dawg™ or Drain Kat™	EA	1
CB-03	3/4in. cone tip with female thread for Drain Dawg™ or Drain Kat™ blow gun	EA	1
CK-141	3/4in. cone with male thread for use with whip hose for Drain Dawg™ or Drain Kat™	EA	1
CW-15	15in. whip hose for Drain Dawg™ or Drain Kat™	EA	1
DF-75	Drain Dawg™ inflatable tip for drain line blowout	EA	1
FA-01	Nitrogen to CO2 adapter, male by male for Drain Kat™	EA	1
FA-02	Nitrogen to CO2 adapter, female by female for Drain Dawg™	EA	1
FA-03	CO2 transfill adapter for Drain Kat™	EA	1
QN-S3	Needle tip with female thread for Drain Dawg™ or Drain Kat™ blow gun	EA	1
TC-25	Tire chuck for Drain Dawg™	EA	1
TG-10	120in. blow gun hose for Drain Dawg™	EA	1
TG-87A	87in. blow gun hose for Drain Kat™	EA	1

DF-75



## CONDENSATE DRAIN PANS, FITTINGS, ADAPTERS

### A/C Secondary Condensate Drain Pans

Rolled edges for durability, ribbed bottoms for rigidity, and reinforced corners for strength. 3/4in. PVC fittings are included with each pan. No seams, no rust, and no leakage. ABS materials will not put out toxic smoke. Available in over 20 convenient sizes. Five pans per clip.

CATALOG NO.	BOTTOM DIMENSION		OVERALL DIMENSION		DEPTH		UOM	ORDER MULTIPLE
	IN.	CM.	IN.	CM.	IN.	CM.		
6-1838L	18" x 38"	46 x 97	20" x 40"	51 x 102	2"	5	EA	5
6-1838S	18" x 38"	46 x 97	20" x 40"	51 x 102	2"	5	EA	5
6-1846L	18" x 46"	46 x 117	20" x 48"	51 x 122	2"	5	EA	5
6-1846S	18" x 46"	46 x 117	20" x 48"	51 x 122	2"	5	EA	5
6-2424L	24" x 24"	61 x 61	26" x 26"	66 x 66	2"	5	EA	5
6-2626L	26" x 26"	66 x 66	28" x 28"	71 x 71	2"	5	EA	5
6-2739L	27" x 39"	69 x 99	29" x 41"	74 x 104	2"	5	EA	5
6-2748L	27" x 48"	69 x 122	29" x 50"	74 x 127	2"	5	EA	5
6-2748S	27" x 48"	69 x 122	29" x 50"	74 x 127	2"	5	EA	5
6-2748L-100	27" x 48"	69 x 122	29" x 50"	74 x 127	2"	5	EA	100
6-2763L	27" x 63"	69 x 160	29" x 65"	74 x 165	2"	5	EA	5
6-2763S	27" x 63"	69 x 160	29" x 65"	74 x 165	2"	5	EA	5
6-3030L	30" x 30"	76 x 76	32" x 32"	81 x 81	2"	5	EA	5
6-3050L	30" x 50"	76 x 127	32" x 52"	81 x 132	2"	5	EA	5
6-3050S	30" x 50"	76 x 127	32" x 52"	81 x 132	2"	5	EA	5
6-3060L	30" x 60"	76 x 152	32" x 62"	81 x 157	2"	5	EA	5
6-3060S	30" x 60"	76 x 152	32" x 62"	81 x 157	2"	5	EA	5
6-3060L-100	30" x 60"	76 x 152	32" x 62"	81 x 157	2"	5	EA	100
6-3263L	32" x 63"	81 x 160	34" x 65"	86 x 165	2"	5	EA	5
6-3263S	32" x 63"	81 x 160	34" x 65"	86 x 165	2"	5	EA	5
6-3636L	36" x 36"	91 x 91	38" x 38"	97 x 97	2"	5	EA	5
6-3660L	36" x 60"	91 x 152	38" x 62"	97 x 157	2"	5	EA	5
6-3660S	36" x 60"	91 x 152	38" x 62"	97 x 157	2"	5	EA	5

L = Drain Line Outlets in Long Side

S = Drain Line Outlets in Short Side

6-1838L



**CONDENSATE DRAIN PANS, FITTINGS, ADAPTERS**

**High Rise Pans™**

The High Rise Pan™ is an innovative new plastic drain pan design which allows placement of an air handler 2 3/4in. above the outside lip of the pan without the need for separate, cumbersome mounting blocks. The pan has a molded in network of risers to give a 5in. lift. The risers are positioned to accept a wide variety of air handler sizes. Each riser has a specially shaped area at each end to accommodate a 2in. x 2in. anti vibration pad which allows for quiet operation at all times. Other features include heavy duty reinforcement throughout to give plenty of support as well as rolled edges for durability. One piece plastic construction ensures no rust, leaks, or seams to split. Each High Rise Pan™ comes complete with a Condensate Cop™ float switch, 6 EVA™ anti vibration pads, and 1 3/4in. PVC male adapter. Installation is straightforward and hassle free.



CATALOG NO.	DESCRIPTION	UOM	ORDER MULTIPLE
6-HK2748	High Rise Pan™ 27" x 48" with Installation Kit including: One CC-1 Condensate Cop, Six MP-2E 2" x 2" EVA™ Pads, One 6-1 3/4" PVC male adapter	EA	5
6-HK2748-1	Single Pack Kit – High Rise Pan™ 27" x 48" with Installation Kit including: One CC-1 Condensate Cop, Six MP-2E 2" x 2" EVA™ Pads, One 6-1 3/4" PVC male adapter	EA	1
6-HK2766	High Rise Pan™ 27" x 66" with Installation Kit including: One CC-1 Condensate Cop, Six MP-2E 2" x 2" EVA™ Pads, One 6-1 3/4" PVC male adapter	EA	5
6-HK2766-1	Single Pack Kit – High Rise Pan™ 27" x 66" with Installation Kit including: One CC-1 Condensate Cop, Six MP-2E 2" x 2" EVA™ Pads, One 6-1 3/4" PVC male adapter	EA	1
6-HK3050	High Rise Pan™ 30" x 50" with Installation Kit including: One CC-1 Condensate Cop, Six MP-2E 2" x 2" EVA™ Pads, One 6-1 3/4" PVC male adapter	EA	5
6-HK3050-1	Single Pack Kit – High Rise Pan™ 30" x 50" with Installation Kit including: One CC-1 Condensate Cop, Six MP-2E 2" x 2" EVA™ Pads, One 6-1 3/4" PVC male adapter	EA	1
6-HK3060	High Rise Pan™ 30" x 60" with Installation Kit including: One CC-1 Condensate Cop, Six MP-2E 2" x 2" EVA™ Pads, One 6-1 3/4" PVC male adapter	EA	5
6-HK3060-1	Single Pack Kit – High Rise Pan™ 30" x 60" with Installation Kit including: One CC-1 Condensate Cop, Six MP-2E 2" x 2" EVA™ Pads, One 6-1 3/4" PVC male adapter	EA	1

**Metal Drain Pan**

The ultimate in drain pan design — tailored for easy distribution and installation. Full of features to make life easier on both the distributor and the contractor. Seamless, one piece metal construction with rolled edges on all sides for maximum safety and integrity. Nestable as well — a stack of 70 pans is only a foot high! Once on site, you'll never have to return to the distributor for missing parts. The fittings are packaged with the pan for simple and efficient installation. Choose between two possible drain outlet positions and install with confidence.



CATALOG NO.	DESCRIPTION	UOM	ORDER MULTIPLE
6-M2748	26 Gauge Metal Drain Pan – 27" x 48"	EA	5
6-M2763	26 Gauge Metal Drain Pan – 27" x 63"	EA	5
6-M3030	26 Gauge Metal Drain Pan – 30" x 30"	EA	5
6-M3050	26 Gauge Metal Drain Pan – 30" x 50"	EA	5
6-M3060	26 Gauge Metal Drain Pan – 30" x 60"	EA	5
6-M3263	26 Gauge Metal Drain Pan – 32" x 63"	EA	5

**Mini-Split Drain Adapters**

Mini Split fan units — either ceiling cassettes or wall cassettes — typically have a unique (metric) drain line fitting. DiversiTech's adapters convert this metric fitting to standard drain line tubing sizes.



CATALOG NO.	DESCRIPTION	UOM	ORDER MULTIPLE
230-DLFY	Mini-Split Drain Line Wye	EA	1
230-DLF16	16mm Mini-Split Drain Line Adapter	EA	1
230-DLF18	18mm Mini-Split Drain Line Adapter	EA	1
230-DLF20	20mm Mini-Split Drain Line Adapter	EA	1
230-DLF25	25mm Mini-Split Drain Line Adapter	EA	1
230-DLF32	32mm Mini-Split Drain Line Adapter	EA	1

**A/C Condensate Drain Pan Fittings**

The Drain Pan Fittings are designed to be used with our Condensate Drain Pans.



CATALOG NO.	DESCRIPTION	UOM	ORDER MULTIPLE
6-1	3/4" Slip	EA	50
6-2	1" Slip	EA	50
6-3	3/4" Slip with Plastic Nut	EA	50
6-5	3/4" Female Pipe Thread	EA	50

**Condensate Drain Pans**

When a mini split system operates in heat pump mode, the outdoor coil becomes the evaporator coil. Typically, condensation generates from the evaporator coil. In certain installations, the condenser coil may be mounted overhead on brackets affixed to a wall. In these overhead applications, dripping condensation may be a nuisance. Condensate drain pans bolt onto the condenser mounting brackets, and the drain line can be plumbed to a nearby drain location. Furnished complete with all mounting hardware and drain pan outlet, condensate drain pans are available in either plastic or powder coated steel.



CATALOG NO.	DESCRIPTION	UOM	ORDER MULTIPLE
230-DPPL	Poly Condensate Drain Pan (Large)	EA	1
230-DPML	Metal Condensate Drain Pan (Large)	EA	1
230-DPPM	Poly Condensate Drain Pan (Medium)	EA	1
230-DPMM	Metal Condensate Drain Pan (Medium)	EA	1



## DRAIN LINE, TUBING

### Mini-Split Condensate Drain Line

A unique drain line for mini-split units. This large diameter drain line is typical for mini-split installations. Furnished in 160 feet lengths with cut marks every 3.28 feet. Accommodates 5/8" and 3/4" connections.



CATALOG NO.	DESCRIPTION	UOM	ORDER MULTIPLE
230-DL16	5/8" ID Mini-Split Drain Line	EA	160'
230-DL16-20	5/8" ID Mini-Split Drain Line – 20' section	EA	1

### Gorilla Tube™ Clear Vinyl Tubing

Applications include: air conditioning and refrigeration condensate drains, condensate pump discharge lines, and humidifier overflows. Several sizes from 1/4" to 1" diameter. Non-toxic clear vinyl chloride.

Select Gorilla Tube™ over standard clear vinyl tube because:

- Extra rigid design resists crimping and kinking due to durometer value of 80 (Shore A) and thicker wall
- Maximum service temperature 140°F (60°C)
- Better performance in cold weather climates.



CATALOG NO.	DESCRIPTION	UOM	ORDER MULTIPLE
7-14P	1/4", .250" I.D., .360" O.D., .055 wall thickness	EA	100'
7-38P	3/8", .375" I.D., .495" O.D., .060 wall thickness	EA	100'
7-12P	1/2", .500" I.D., .631" O.D., .066 wall thickness	EA	100'
7-58P	5/8", .625" I.D., .771" O.D., .073 wall thickness	EA	100'
7-34P	3/4", .750" I.D., .913" O.D., .082 wall thickness	EA	100'
7-78P	7/8", .875" I.D., 1.050" O.D., .088 wall thickness	EA	50'
7-10P	1", 1.000" I.D., 1.215" O.D., .108 wall thickness	EA	50'

### Clear Vinyl Tubing

Clear vinyl hose applications include: air conditioning and refrigeration condensate drains, condensate pump discharge lines and humidifier overflows.



CATALOG NO.	DESCRIPTION	UOM	ORDER MULTIPLE
7-316	3/16" ID Clear Vinyl Tubing – 100' section	EA	100'
7-14	1/4" ID Clear Vinyl Tubing – 100' section	EA	100'
7-38	3/8" ID Clear Vinyl Tubing – 100' section	EA	100'
7-12	1/2" ID Clear Vinyl Tubing – 100' section	EA	100'
7-58	5/8" ID Clear Vinyl Tubing – 100' section	EA	100'
7-34	3/4" ID Clear Vinyl Tubing – 100' section	EA	100'
7-78	7/8" ID Clear Vinyl Tubing – 100' section	EA	50'
7-10	1" ID Clear Vinyl Tubing – 100' section	EA	50'

## TAPES

### Cork Insulation Tape

Adheres firmly to all metals. Use on hot or cold pipes to stop condensation and drips.



CATALOG NO.	DESCRIPTION	UOM	ORDER MULTIPLE
6-330	Cork Insulation Tape – 1/8" x 2" x 30' Roll – Black	EA	12

### PTFE Tape

Made of pure white PTFE. Non toxic. For use with chemicals, solvents, oxygen, and on food lines. Withstands up to 2000 psi of pressure.



CATALOG NO.	DESCRIPTION	UOM	ORDER MULTIPLE
6-733	Teflon Tape – 1/2" x 520"	EA	100
6-734	Teflon Tape – 1/2" x 260"	EA	100
6-735	Teflon Tape – 3/4" x 520"	EA	100
6-736	Teflon Tape – 3/4" x 260"	EA	100

### Foam Insulation Tape

Superior self-adhesive foam tape can be used on hot or cold pipes. Fits well around valves and fittings. Easily cut and molded.



CATALOG NO.	DESCRIPTION	UOM	ORDER MULTIPLE
6-9718	Foam Insulation Tape – 1/8" x 2" x 30' Roll – Black	EA	12

# In a class by itself.



**DIVERSITECH**®



The **ClearVue™** condensate pump isn't like all the other pumps. It features Floatless Sensor™ technology for super reliable operation without a mechanical float — No Float, No Problems. And ClearVue even has a brain. Built-in Variable Speed and Lift adjusts pump speed and lift as needed so ClearVue can adapt to any conditions. ClearVue even cleans itself to ensure worry-free operation. Learn more about how ClearVue stands out from the crowd at [www.diversitech.com](http://www.diversitech.com)

# GENERAL INDUSTRIAL

Abrasive Cloths.....74  
 Aerosols .....74  
 Batteries By Rayovac® .....75  
 Carton Sealing Tape and Dispenser .....75  
 Contact Cleaners ..... 75-76  
 Degreasers.....76  
 Hand Cleaners.....76  
 Industrial Towels .....77  
 Lubricants ..... 77-78  
 Markers.....79  
 Paints and Primers .....79  
 Safety Supplies, Devices .....80  
 Sealant, Epoxy, Glue.....81  
 Sealing Compounds, Adhesive..... 81-83  
 Sheet Metal Screws ..... 83-84  
 Wasp, Hornet, and Yellow Jacket Killers.....84



**ABRASIVE CLOTHS**

**All Purpose Cleaning Pads**

For cleaning copper tubes and fittings. Made of nylon and will not rust. Can be used wet or dry. Leaves no residue and is long lasting.



**ACP-10**

CATALOG NO.	DESCRIPTION	UOM	ORDER MULTIPLE
<b>ACP-10</b>	All Purpose Cleaning Pads – pack of 10	PK	1

**Abrasive Cloth**

Aluminum oxide, high quality 120 grit, abrasive cloth to thoroughly clean copper and steel tubing. Works wet or dry. Exceeds industry standards for abrasive cloth.



**SC-10**

CATALOG NO.	DESCRIPTION	UOM	ORDER MULTIPLE
<b>SC-10</b>	Abrasive Cloth – 1-1/2" x 10 yds.	EA	24
<b>SC-25</b>	Abrasive Cloth – 1-1/2" x 25 yds.	EA	12

**Grip-Cut™**

Open mesh sand screen cloth. Aluminum oxide grain resin bonded to synthetic nylon cloth. 100% waterproof, but can also be used dry for sanding by hand or with portable tools. Most effective where clogging is a problem, such as soft materials. 180 grit.



**SCM-5**

CATALOG NO.	DESCRIPTION	UOM	ORDER MULTIPLE
<b>SCM-5</b>	Grip-Cut™ – 1-1/2" x 5 yds.	EA	24
<b>SCM-10</b>	Grip-Cut™ – 1-1/2" x 10 yds.	EA	24
<b>SCM-25</b>	Grip-Cut™ – 1-1/2" x 25 yds.	EA	12

**AEROSOLS**

**Sure-Stick Heavy Duty Adhesive Spray**

Wide web spray adhesive ideal for both temporary or permanent bonding. Waterproof, transparent and non-staining. Use for the toughest adhesive applications with leather, cardboard, most plastics, polyethylene sheeting and insulation in HVAC applications. Cleans with mineral spirits. Not for use on vinyl.



**315-20**

CATALOG NO.	DESCRIPTION	UOM	ORDER MULTIPLE
<b>315-20</b>	Sure-Stick Adhesive Spray – 12 oz. Aerosol	EA	12

**CBC II Contact Cleaner**

A plastic safe, non flammable electronic contact and circuit board cleaner. Dries fast, leaves no residue. No harsh fumes or odors.



**362-16**

CATALOG NO.	DESCRIPTION	UOM	ORDER MULTIPLE
<b>362-16</b>	CBC II Contact Cleaner – 10 oz. Aerosol	EA	12

**Sweat-Free Pipe Insulation Spray**

An aerosol spray on insulation specifically developed for cold water pipes, refrigeration and air conditioning lines. Stops sweating and dripping problems. Dries to a clean, white, flexible and water resistant coating. Adheres to galvanized, black iron, steel, brass, copper and PVC piping.



**770-15**

CATALOG NO.	DESCRIPTION	UOM	ORDER MULTIPLE
<b>770-15</b>	Sweat-Free Pipe Insulation – 15 oz. Aerosol	EA	12

**Glass Cleaner**

A foaming premium glass cleaner that powers through the toughest grease and grime on any glass or hard surface. Leaves a streak-free shine.



**325-12**

CATALOG NO.	DESCRIPTION	UOM	ORDER MULTIPLE
<b>325-12</b>	Glass Cleaner – 19 oz. Aerosol	EA	12

## BATTERIES BY RAYOVAC®

**Rayovac is the Industrial Product Leader!** Rayovac is the leader in the industrial battery market and has been for years, with an estimated 50% share of the traditional industrial distribution channel. Rayovac introduced the top-selling industrial flashlight to the market, and set the quality standard by which all other industrial flashlights are measured today. Whether your customer is searching for a toolbox-tough flashlight or high-performance batteries, Rayovac offers a broad range of products to meet your needs.

### Rayovac Industrial Maximum Alkaline Batteries – Shrink Packed

- Same battery performance as the Contractor Packs at a lower cost
- Formulated specifically to exceed the everyday demands of industrial applications
- Outstanding dependability for "must work" applications



CATALOG NO.	DESCRIPTION	UOM	ORDER MULTIPLE
<b>7-ALAA</b>	Alkaline AA Battery – Shrink Packed, pack of 8	EA	8
<b>7-ALAAA</b>	Alkaline AAA Battery – Shrink Packed, pack of 8	EA	8
<b>7-ALC</b>	Alkaline C Battery – Shrink Packed, pack of 6	EA	6
<b>7-ALD</b>	Alkaline D Battery – Shrink Packed, pack of 6	EA	6
<b>7-AL9V</b>	Alkaline 9V Battery – Shrink Packed, pack of 6	EA	6

### Rayovac Lantern Batteries

- Dependable performance — for "must work" applications
- Available in General Purpose, Heavy Duty, and Alkaline Maximum



CATALOG NO.	DESCRIPTION	UOM	ORDER MULTIPLE
<b>7-6VGP</b>	6 Volt General Purpose – Spring Terminals, pack of 12	EA	12
<b>7-6VHD</b>	6 Volt Heavy Duty – Spring Terminals, pack of 12	EA	12
<b>7-6VHDM</b>	6 Volt Heavy Duty Maximum – Spring Terminals, pack of 12	EA	12
<b>7-806</b>	6 Volt Alkaline Maximum – Spring Terminals, pack of 6	EA	6
<b>7-918</b>	6 Volt General Purpose – Screw Terminals, pack of 6	EA	6
<b>7-944</b>	6 Volt Lantern Battery, pack of 6	EA	6

### Rayovac Industrial Maximum Alkaline Batteries — Contractor Packs

- Contractor preferred, clear, re-sealable package
- Greater battery per pack quantities command higher battery sales
- Displays much more readily than other competitive batteries
- In an HVAC test market, the Contractor Packs outsold the standard packs by a greater than 2 to 1 ratio!



CATALOG NO.	DESCRIPTION	UOM	ORDER MULTIPLE
<b>7-ALAA-24</b>	Alkaline AA Battery – Contractor Pack, pack of 24	EA	24
<b>7-ALAAA-18</b>	Alkaline AAA Battery – Contractor Pack, pack of 18	EA	18
<b>7-ALC-12</b>	Alkaline C Battery – Contractor Pack, pack of 12	EA	12
<b>7-ALD-12</b>	Alkaline D Battery – Contractor Pack, pack of 12	EA	12
<b>7-AL9V-8</b>	Alkaline 9V Battery – Contractor Pack, pack of 8	EA	8

## CARTON SEALING TAPE AND DISPENSER

### Carton Sealing Tape

This Clear 2.4 mil Sealing Tape is 2in. nominal width and is 110 yds. in length



CATALOG NO.	DESCRIPTION	UOM	ORDER MULTIPLE
<b>540-2110C</b>	Carton Sealing Tape – 2" x 110 Yards – Clear	EA	36

### Carton Tape Dispenser

A Heavy Duty Tape Dispenser that holds 2in. Tape.



CATALOG NO.	DESCRIPTION	UOM	ORDER MULTIPLE
<b>540-DISP</b>	2" Carton Tape Dispenser	EA	1

## CONTACT CLEANERS

### HF™ Contact Cleaner

A petroleum distillate based precision cleaner with a flash point of 205°F. It can be an alternative to CFCs when applications require higher flashpoints.



CATALOG NO.	DESCRIPTION	UOM	ORDER MULTIPLE
<b>CRC-4-140</b>	HF™ Contact Cleaner – 11 oz.	EA	12

### QD® Contact Cleaner

This contact cleaner is suitable for cleaning sensitive electronics and electrical equipment and does not leave any residue. It evaporates quickly and is safe to use on all plastics. This product is more useful where lower flashpoint cleaners are acceptable. The QD® Contact Cleaner is NSF K2 Registered.



CATALOG NO.	DESCRIPTION	UOM	ORDER MULTIPLE
<b>CRC-4CF</b>	QD® Contact Cleaner – 11 oz.	EA	12

**CONTACT CLEANERS** cont'd

**Electronic Degreaser**

This Advanced Technology Formula is non-chlorinated, non-conductive, non-corrosive and non-staining. It rapidly dissolves grease, oil and sludge for better efficiency of mechanical equipment. The Electronic Degreaser has no flash or fire point.



CATALOG NO.	DESCRIPTION	UOM	ORDER MULTIPLE
<b>CRC-4NU</b>	Electronic Degreaser – 15 oz.	EA	12

**DEGREASERS**

**Heavy Duty Degreaser**

This degreaser rapidly and effectively removes grease, oil, tar, and other residue to increase operating efficiency of equipment. It has no flash or fire point, making it an excellent alternative to 1,1,1-based cleaners. Please use caution on plastics.



CATALOG NO.	DESCRIPTION	UOM	ORDER MULTIPLE
<b>CRC-7X</b>	Heavy Duty Degreaser – 19 oz.	EA	12

**Heavy Duty Degreaser II**

The Heavy Duty Degreaser II is a non-chlorinated, zero VOC formula for cleaning where chlorinated solvents are prohibited. It has a high flashpoint of 180°F. This degreaser effectively removes soils with no residue build-up. Please exercise caution on plastics.



CATALOG NO.	DESCRIPTION	UOM	ORDER MULTIPLE
<b>CRC-7-140</b>	Heavy Duty Degreaser II – 15 oz.	EA	12

**Chlor-Free® Degreaser**

Non-chlorinated degreasing solvent which is used to remove oil, grease and other contaminants. It is especially useful for applications requiring a quick turnaround and where a low flashpoint solvent can be used.



CATALOG NO.	DESCRIPTION	UOM	ORDER MULTIPLE
<b>CRC-7Z</b>	Chlor-Free® Degreaser – 14 oz.	EA	12

**Citrus Degreaser**

The Citrus Degreaser has a new Low VOC Formula. The product removes grease, oil and lubricants with no water wash-off. It evaporates quickly and leaves no residue. The product gives off a pleasant citrus scent and is NSF C1 Registered.



CATALOG NO.	DESCRIPTION	UOM	ORDER MULTIPLE
<b>CRC-7PS</b>	Citrus Degreaser – 15 oz.	EA	12

**HAND CLEANERS**

**Fast Orange® Hand Cleaner**

Three out of five people prefer Fast Orange® over other hand cleaners. The first biodegradable, waterless hand cleaner with aloe, lanolin, and jojoba. Smooth lotion and extra-fine pumice available. USDA Approved.



CATALOG NO.	DESCRIPTION	UOM	ORDER MULTIPLE
<b>HCO-7</b>	Fast Orange® – 7-1/2 fl. oz. Smooth Squeeze Bottle	EA	12
<b>HCO-15</b>	Fast Orange® – 15 oz. Smooth Squeeze Bottle	EA	6
<b>HCO-128</b>	Fast Orange® – 1 Gallon Smooth with Dispenser	EA	4
<b>HCP-7</b>	Fast Orange® – 7-1/2 fl. oz. Pumice Squeeze Bottle	EA	12
<b>HCP-15</b>	Fast Orange® – 15 oz. Pumice Squeeze Bottle	EA	12

**Kimberly-Clark Waterless Hand Wipes**

These wipes go wherever hands go to get dirty. Full sized 12" x 12" wipes for full sized cleaning. Natural cleaning agent is tough on grease, grime, ink, and paint. Dual textured – smooth for wiping on one side and tough for scrubbing on the other. More wipes with our 75 count bucket.



CATALOG NO.	DESCRIPTION	UOM	ORDER MULTIPLE
<b>5-42272</b>	Kimberly-Clark Waterless Hand Wipes – Bucket	EA	1
<b>5-91054</b>	Kimberly-Clark Waterless Hand Wipes – Singles	EA	100

## INDUSTRIAL TOWELS

### WypAll Plus

Absorbs grease, oil, water and solvents from floors, hands, parts, tools and machinery. Tough enough for extra heavy jobs. Comes in a convenient pop-up box of 100 towels.



5-05790

CATALOG NO.	DESCRIPTION	UOM	ORDER MULTIPLE
5-05790	WypAll Plus Towels—White, pack of 100	PK	1

### Teri® Towels

The Teri® reinforced towels feature multi-ply tissue reinforced with nylon webbing for added strength on the job. Made from 100% recycled paper. Towel size is 9-3/4" x 16-3/4". Towel color is white. Comes in a convenient pop up box. 126 towels/box. 10 boxes/case.



5-34790

CATALOG NO.	DESCRIPTION	UOM	ORDER MULTIPLE
5-34790	Teri Reinforced Towels, pack of 126	PK	1

### Workhorse® Manufactured Rags

The economical alternative to scrap rags. Workhorse® Manufactured Rags is the first product to be made from Kimberly-Clark's advanced new material – Hydrokni®. Durable, rag tough construction stands up to any task. Can be re-used time and time again. Available in white or blue.



5-41455

CATALOG NO.	DESCRIPTION	UOM	ORDER MULTIPLE
5-41455	9-3/4" x 16-3/4" White, pack of 100	PK	1
5-41411	9-3/4" x 16-3/4" Blue, pack of 100	PK	1

### Shop Towels

Heavy duty reusable towels. For wipe ups of grease, oil, water, etc. 100% cotton material is pre-shrunk and hemmed. Each towel measures 13" x 16".



ST-10

CATALOG NO.	DESCRIPTION	UOM	ORDER MULTIPLE
ST-4	Shop Towels, pack of 4	PK	1
ST-10	Shop Towels, pack of 10	PK	1
ST-24	Shop Towels, pack of 24	PK	1

### Kimtex® Towels

Long lasting Kimtex® stands up to oils, chemicals and solvents better than ordinary shop towels. Cloth-like feel and performance. Towel size is 9-3/4" x 16-3/4". 100 towels/box. 5 boxes/case.

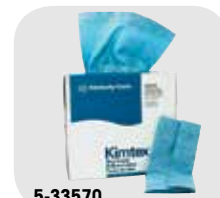

5-33570

CATALOG NO.	DESCRIPTION	UOM	ORDER MULTIPLE
5-33570	Kimtex Shop Towels, pack of 100	PK	1

### WypAll ShopPro X80 Towels

Like a rental shop towel, only more consistent. Engineered to feel like cloth and work even better. Absorbs more oil and water faster pound for pound than laundered shop towels. The ShopPro X80 is simply the heaviest duty towel in the Kimberly Clark line. 160 towels/box.



5-41041

CATALOG NO.	DESCRIPTION	UOM	ORDER MULTIPLE
5-41041	WypAll ShopPro X80 Towels, pack of 160	PK	1
5-41043	WypAll ShopPro X80 Towels, roll of 465	PK	1

### Terry Towels

100% cotton. Minimum of 14" x 17". Pre-washed for absorbency, fully-hemmed, all-white, and reusable.

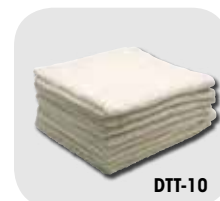

DTT-10

CATALOG NO.	DESCRIPTION	UOM	ORDER MULTIPLE
DTT-10	Terry Towels, pack of 10	PK	1
DTT-24	Terry Towels, pack of 24	PK	1

## LUBRICANTS

### Knock'er Loose® Penetrating Solvent

An industrial strength, low viscosity penetrant designed to rapidly loosen and free seized, bound or frozen fasteners. This product also quickly permeates rust, scale, gum, grease and corrosion. Independent tests reveal that it outperforms its competition.



CRC-1KB

CATALOG NO.	DESCRIPTION	UOM	ORDER MULTIPLE
CRC-1KB	Knock'er Loose® Penetrating Solvent – 13 oz.	EA	12

### Screwloose® Industrial Penetrating Oil

A no compromise penetrant that attacks corrosion to free corroded fasteners and mechanical components. A super fast, powerful, concentrated penetrating solvent that loosens rust scale and corrosion and instantly penetrates minute and tightly fitted crevices.



CRC-8

CATALOG NO.	DESCRIPTION	UOM	ORDER MULTIPLE
CRC-8	Screwloose® Industrial Penetrating Oil – 11 oz.	EA	12

LUBRICANTS cont'd

**White Lithium Grease**

White Lithium Grease has superior lubrication and durability in any weather or temperature. It is useful as a break in lubricant for bearings or as a general purpose lubricant and corrosion inhibitor for tools, machinery and equipment.



CRC-9

CATALOG NO.	DESCRIPTION	UOM	ORDER MULTIPLE
CRC-9	White Lithium Grease – 10 oz.	EA	12

**Ultra Lite 3-36® Ultra Thin Non Staining Lubricant**

Ultra thin, non staining lubricant that resists oil, dirt and dust build up. This lubricant also seals out moisture and protects against corrosion. It is excellent for drying out electrical components.



CRC-1

CATALOG NO.	DESCRIPTION	UOM	ORDER MULTIPLE
CRC-1	Ultra Lite 3-36® Ultra Thin Non Staining Lubricant – 11 oz.	EA	12

**3-36® Multi-Purpose Lubricant & Corrosion Inhibitor**

A multi-purpose petroleum based compound that forms a clear, thin film that lubricates and protects against wear and corrosion. The product also displaces moisture and cleans.



CRC-2

CATALOG NO.	DESCRIPTION	UOM	ORDER MULTIPLE
CRC-2	3-36® Multi-Purpose Lubricant & Corrosion Inhibitor – 11 oz.	EA	12

**SP-400™ Corrosion Inhibitor**

Long-term corrosion inhibitor that protects equipment subject to heat, humidity, chemicals or severely corrosive atmospheres. This product is best to use on machined surfaces and assemblies subjected to long periods of storage.



CRC-3

CATALOG NO.	DESCRIPTION	UOM	ORDER MULTIPLE
CRC-3	SP-400™ Corrosion Inhibitor – 10 oz.	EA	12

**Zinc-It® Instant Cold Galvanize™ Zinc Rich Galvanize Coating**

High-performance zinc coating that electrochemically bonds with ferrous metals to form a galvanic cell. The product also fights rust and corrosion and can be used as a touch-up for damaged galvanized coatings. Zinc-It® Instant Cold Galvanize™ Zinc Rich Galvanize Coating dries quickly.



CRC-5

CATALOG NO.	DESCRIPTION	UOM	ORDER MULTIPLE
CRC-5	Zinc-It® Instant Cold Galvanize™ Zinc Rich Galvanize Coating – 13 oz.	EA	12

**Sta-Plex™ Extreme Pressure Premium Red Grease**

A superior multi-purpose certified lithium complex based grease which contains extreme pressure, anti-wear, and anti-oxidation additives. The product is very useful in high temperature and performance applications. The drop point is 500°F.



CRC-13

CATALOG NO.	DESCRIPTION	UOM	ORDER MULTIPLE
CRC-13	Sta-Plex™ Extreme Pressure Premium Red Grease – 14 oz.	EA	12

**WD-40®**

Loosens rusted parts. Stops squeaks. Removes tar, grease and adhesives. Displaces moisture. Protects metal. New Smart Straw can.



741-002

741-001

CATALOG NO.	DESCRIPTION	UOM	ORDER MULTIPLE
741-001	WD-40 – 8 oz.	EA	12
741-002	WD-40 – 11 oz.	EA	12

**Heavy Duty Silicone Mold Release**

This product provides maximum releases and is useful in difficult to remove parts. The Heavy Duty Silicone Mold Release is colorless, odorless, non-staining and non-corrosive.



CRC-6

CATALOG NO.	DESCRIPTION	UOM	ORDER MULTIPLE
CRC-6	Heavy Duty Silicone Mold Release – 12 oz.	EA	12

**Pull-A-Spout Oiler**

All purpose oiler with a 14in. telescoping spout. Zooms out for long shots, and in for short shots, even zooms around corners. Squeeze bottle action. Perfect lubricant for general industrial use. Contains four ounces of finest quality carbon free, rust and oxidation inhibited lubricating oil. Plastic container won't short out around electrical connections. No leakage.



CO-1

CATALOG NO.	DESCRIPTION	UOM	ORDER MULTIPLE
CO-1	Pull-A-Spout Oiler – 4 oz. – (Display)	EA	12



**MARKERS**

**Valve Action Marker**

Large ink supply for increased mileage. Fast drying, smear and water resistant. Utilizes a patented valve-activated ink feed mechanism to supply ink as required, down to the last drop.



CATALOG NO.	DESCRIPTION	UOM	ORDER MULTIPLE
540-799	Valve Action Marker-Regular Tip – Red	EA	12
540-800	Valve Action Marker-Regular Tip – Black	EA	12

**Valve Action Paint Marker**

Bright, crisp, opaque colors. The oil-based paint is quick drying and permanent on most surfaces. These markers also feature the patented valve-operated feed mechanism and a medium point.



CATALOG NO.	DESCRIPTION	UOM	ORDER MULTIPLE
540-805	Valve Action Paint Marker – Black	EA	12
540-806	Valve Action Paint Marker – Red	EA	12
540-807	Valve Action Paint Marker – White	EA	12
540-808	Valve Action Paint Marker – Yellow	EA	12

**Felt Tip Markers**

Sharpie® King-Sized Permanent Marker for metal, glass, paper and plastic. Durable metal body.



CATALOG NO.	DESCRIPTION	UOM	ORDER MULTIPLE
540-811B	Sharpie® King-Sized Marker	EA	12

**PAINTS AND PRIMERS**

**General Purpose Spray Paint**

New, more complete line of professional quality fast drying spray paints. Color code compressors or refrigerant recovery cylinders to match standard refrigerant identifying colors. Touch up equipment housings. Product meets most recent VOC legislation and is currently compliant.



CATALOG NO.	DESCRIPTION	UOM	ORDER MULTIPLE
799-001	Spray Paint – Gloss Black – 12 oz.	EA	6
799-002	Spray Paint – Flat Black – 12 oz.	EA	6
799-003	Spray Paint – Gloss White – 12 oz.	EA	6
799-004	Spray Paint – Flat White – 12 oz.	EA	6
799-005	Spray Paint – Dark Machinery Gray – 12 oz.	EA	6
799-006	Spray Paint – Gray Primer – 12 oz.	EA	6
799-008	Spray Paint – Bright Yellow – 12 oz.	EA	6
799-009	Spray Paint – Astro Blue – 12 oz.	EA	6
799-010	Spray Paint – Orange – 12 oz.	EA	6
799-011	Spray Paint – Aluminum (Silver) – 12 oz.	EA	6
799-012	Spray Paint – Zinc Rich Primer – 14 oz.	EA	6
799-013	Spray Paint – Bright Red – 12 oz.	EA	6

**Industrial Enamel**

Finally an aerosol paint that sprays in any direction without clogging. We guarantee it! Dries tack free in 10 to 20 minutes; fully dry in just one hour. Excellent corrosion and solvent resistance. Resists heat up to 250°F. Now in 20 oz. cans. Product meets most recent VOC legislation and is currently compliant.



CATALOG NO.	DESCRIPTION	UOM	ORDER MULTIPLE
799-020	Industrial Enamel – Gloss Black – 12 oz.	EA	6
799-021	Industrial Enamel – Flat Black – 12 oz.	EA	6
799-022	Industrial Enamel – Gloss White – 12 oz.	EA	6
799-024	Industrial Enamel – Machinery Light Gray – 12 oz.	EA	6
799-025	Industrial Enamel – Aluminum – 12 oz.	EA	6
799-026	Industrial Enamel – OSHA Red – 12 oz.	EA	6

**High Heat Spray Paint**

An ultra high temperature coating formulated to resist temperatures up to 1300°F. Great for use on boilers, furnaces, steam pipes, chimney collars, compressors and engine manifolds. Product meets most recent VOC legislation and is currently compliant.



CATALOG NO.	DESCRIPTION	UOM	ORDER MULTIPLE
799-040	High Heat Spray Paint – Aluminum – 12 oz.	EA	6
799-041	High Heat Spray Paint – Black – 12 oz.	EA	6

**SAFETY SUPPLIES, DEVICES**

**Latex Gloves**

Disposable natural latex rubber which provide a natural feel and grip. Powdered.



**23010**

CATALOG NO.	DESCRIPTION	UOM	ORDER MULTIPLE
<b>23010</b>	Latex Gloves, pack of 50 pairs	PK	1

**Nitrile Gloves**

Foam control gloves for industrial use that provide a high level of wet and dry grip. Standard in applications where tactile sensitivity is required.



**540-1005L**

CATALOG NO.	DESCRIPTION	UOM	ORDER MULTIPLE
<b>540-1005L</b>	Nitrile Gloves - Large, 1 pair per pack	EA	1

**Heavy Duty Work Gloves**

Your choice of durable work gloves. Washable, breathable, and durable for everyday use.



**540-HU1L**

CATALOG NO.	DESCRIPTION	UOM	ORDER MULTIPLE
<b>540-HU1M</b>	Heavy Utility Gloves - Medium, 1 pair per pack	EA	1
<b>540-HU1L</b>	Heavy Utility Gloves - Large, 1 pair per pack	EA	1
<b>540-BH1M</b>	Box Handler Gloves - Medium, 1 pair per pack	EA	1
<b>540-BH1L</b>	Box Handler Gloves - Large, 1 pair per pack	EA	1
<b>540-LG1M</b>	Leather Gloves - Medium, 1 pair per pack	EA	1

**Dust Masks**

Extremely lightweight, disposable, nuisance dust mask for non-toxic particles. Metal noseclips to fit individual facial contours.

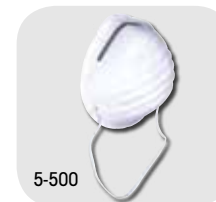

**5-500**

CATALOG NO.	DESCRIPTION	UOM	ORDER MULTIPLE
<b>5-500</b>	Dust Masks, pack of 50	PK	1

**Leather Work Gloves**

Versatile leather work gloves ideal for many industrial jobs. These leather work gloves offer: wing thumb pattern, continuous pull patch, seamless full leather index finger, leather knuckle strap, leather finger tips with elastic gather on back. Generously sized for a good working fit.



**540-2114**

CATALOG NO.	DESCRIPTION	UOM	ORDER MULTIPLE
<b>540-2114</b>	Leather Glove w/Safety Cuff, 1 pair per pack	EA	1
<b>540-2144</b>	Leather Glove, 1 pair per pack	EA	1
<b>540-2200</b>	Renegade® Performance Glove w/Kevlar Thread, 1 pair per pack	EA	1

**First Aid Kits**

10 and 25-unit first aid kits packaged in economy plastic boxes to assist when industrial accidents occur.



**FAK-25**

CATALOG NO.	DESCRIPTION	UOM	ORDER MULTIPLE
<b>FAK-10</b>	10-Unit First Aid Kit	EA	1
<b>FAK-25</b>	25-Unit First Aid Kit	EA	1

**Shoe Covers**

Slip these shoe covers on in seconds to protect carpet, tile, or wood from dirt and scuff marks. Customers will appreciate your professional appearance.



**SC-1**

CATALOG NO.	DESCRIPTION	UOM	ORDER MULTIPLE
<b>SC-1</b>	Dark Blue Shoe Covers, pack of 50 pairs	PK	1
<b>SC-1WP</b>	Waterproof Show Covers, pack of 50 pairs	PK	1

**SEALANT, EPOXY, GLUE**

**Thread Sealant with PTFE**

General purpose sealant with the lubricity of PTFE for metal pipes. Won't shred like PTFE Tape. Allows easy disassembly. Resists common shop fluids. 60° to 400°F temp. resistance. Pressure resistance of 5000 PSI.



7-80632

CATALOG NO.	DESCRIPTION	UOM	ORDER MULTIPLE
7-80632	Thread Sealant – 1/4 Pint Brush Can	EA	12
7-80633	Thread Sealant – 1 Pint Brush Can., 12 per pack	EA	12

**Super Glue**

This adhesive can be used on dirty, greasy surfaces and the medium viscosity penetrates into preassembled and close fitting parts. It can be used on aluminum, metal, rubber, and most plastics for most tough jobs.



DEP052

CATALOG NO.	DESCRIPTION	UOM	ORDER MULTIPLE
DEP052	Super Glue – 2 Gram Tube	EA	12

**J-B Weld**

The world's finest cold-weld compound for use when welding or soldering is out of the question due to cost, down time for repairs, or technical or environmental considerations. A remarkably easy, convenient, and inexpensive alternative to welding, soldering, and brazing. Literally pennies per use.



JB8265

CATALOG NO.	DESCRIPTION	UOM	ORDER MULTIPLE
JB8265	J-B Weld 2 Part Epoxy	EA	1

**Wagner Adhesive Sealant**

For refrigerant sealing. Eliminates fastener loosening, leakage, and corrosion. Cures between thread flanks to seal against leakage and prevents thread corrosion. Offers sealing with maximum solvent resistance to the action of refrigerant (11, 12 and 22), ammonia and sulfur dioxide. Withstands corrosive liquids used in metal finishings and process industries. Ideal sealant for refrigeration, A/C, and process equipment using corrosive chemicals.



CAS-2712

CATALOG NO.	DESCRIPTION	UOM	ORDER MULTIPLE
CAS-2712	Wagner Adhesive Sealant – 0.34 fl. oz.	EA	10

**Fast Cure Epoxy**

DEP056 contains 10 individually wrapped, pre measured packages. Each unique sealed package contains the exact A/B portion required for most small jobs. Easy peel open containers press into shape to form handy mix and dispense cup. Re closable cylinder contains: Ten 0.12 oz. mixer packs and mixing sticks. Epoxy is also available in 1 pound kits (DEP8001 and DEP8002).



DEP8001

DEP056

CATALOG NO.	DESCRIPTION	UOM	ORDER MULTIPLE
DEP056	Epoxy Mixer Cups	EA	10
DEP8001	Aluminum Epoxy Putty – 1 lb. Kit	EA	24
DEP8002	White Epoxy Putty – 1 lb. Kit	EA	24

**SEALING COMPOUNDS, ADHESIVE**

**Foam Sealant – One Component**

One component closed-cell expanding polyurethane foam sealant for lineal caulking applications. Air-moisture cure. Tack free in 20 minutes; fully cured in 12 hours. Paintable. Use for insulating and sealing around windows, doors, pipes, ducts and vents. Non-toxic when cured. Paint to protect from UV exposure. "R" value 4.7 (1" thickness). Foam contains fire retarding chemical and is U.L. Listed but not rated as a firestop product. Environmental concerns have led us to replace CFC's and HCFC's with hydrocarbon material in our one component foam products. See instructions on each product to ensure safe use and quality results.



01714



CATALOG NO.	DESCRIPTION	UOM	ORDER MULTIPLE
01714	Foam Sealant – 12 oz. Can – Yields 275' (3/8" bead)	EA	12
01724	Foam Sealant – 20 oz. Can – Yields 460' (3/8" bead)	EA	12

**Foam Sealant – Two Component**

Two component closed-cell expanding polyurethane foam sealant for cavity filling, surface coating and insulation applications. Rapid chemical cure (Component A and Component B). Tack free in 2 minutes, fully cured in 20 minutes. Use for insulation repairs in refrigerated enclosures. Spray coat and insulate tanks, pipes, tubs and panels. Non-toxic when cured. Paint to protect from UV exposure. "R" value 5 (1" thickness). Kits include dispensing nozzles, hose and flow control mechanism. Foam contains fire retarding chemicals and is U.L. Listed but is not rated as a firestop product.



10012

CATALOG NO.	DESCRIPTION	UOM	ORDER MULTIPLE
10012	Foam – 2 Kit – 15 bd. ft. Kit – Yields 1 cu. ft.	EA	12
10180	Foam – 2 Kit – 200 bd. ft. Kit – Yields 15 cu. ft.	EA	1
10600	Foam – 2 Kit – 600 bd. ft. Kit – Yields 50 cu. ft.	EA	1

### Geocel Caulking Sealant

Exceptional bonding and sealing caulk for interior and exterior applications involving seams, joints, ductwork, flashing and any similar use. Excellent adhesion to virtually any surface (metals, fiberglass, wood, concrete, brick and most plastics) even if moisture is present. Resealable, paintable, flexible. Will not crack, chip or peel. Specially formulated for the HVACR industry. Not available in California.



CATALOG NO.	DESCRIPTION	UOM	ORDER MULTIPLE
18001	Clear Geocel Sealant – 10.3 oz. Cartridge	EA	24
18002	White Geocel Sealant – 10.3 oz. Cartridge	EA	24
18003	Aluminum/Gray Geocel Sealant – 10.3 oz. Cartridge	EA	24

### DiversiGum Sealing Compound

Non-hardening. For plugging openings through foundations or around refrigeration tube entry.



CATALOG NO.	DESCRIPTION	UOM	ORDER MULTIPLE
6-202-1	DiversiGum Sealing Compound – 1 lb. Slug	EA	24
6-202-2	DiversiGum Sealing Compound – 2 lb. Slug	EA	20
AG-25	DiversiGum Sealing Compound – 3/8" x 25' Caulking Cord	EA	12

### Silicone Sealant

Food grade 100% RTV Silicone Sealant. Can be used in applications for continuous use to 450°F. UV and water resistant. Long-term flexibility. Non-paintable. Available in 10.3 fl. oz. tube for use in standard caulk gun or in 3 fl. oz. squeeze tube.



CATALOG NO.	DESCRIPTION	UOM	ORDER MULTIPLE
7-4000	Clear Silicone Sealant – 10.3 fl. oz. Tube	EA	12
7-4001	Clear Silicone Sealant – 3 fl. oz. Squeeze Tube	EA	48
7-4100	White Silicone Sealant – 10.3 fl. oz. Tube	EA	12
7-4101	White Silicone Sealant – 3 fl. oz. Squeeze Tube	EA	48
7-4200	Aluminum Silicone Sealant – 10.3 fl. oz. Tube	EA	12

### 25 Year Acrylic Latex Painter's Caulk

For both interior and exterior use. DiversiTech's 25 Year Acrylic Latex Painter's Caulk forms a tough, paintable resilient bond to all building material surfaces. Excellent resistance to water, weathering and moisture vapor.



CATALOG NO.	DESCRIPTION	UOM	ORDER MULTIPLE
7-4500	White Acrylic Latex Caulk – 10.1 oz. Cartridge	EA	12
7-4400	Clear Acrylic Latex Caulk – 10.1 oz. Cartridge	EA	12

### Firestop Products for Class A Buildings

U.L. Classified. Code Approved. Seal penetrations of plumbing, refrigeration and AC lines, ducts, vents and electrical cable through fire-rated floors, walls and ceilings. Easy-to-use, non-shrinking, non-toxic and permanently flexible. Blocks fire, gas, smoke, air and water migration. Use ceramic fiber filler together with putty or caulk for thick penetrations. Technical bulletins available.



CATALOG NO.	DESCRIPTION	UOM	ORDER MULTIPLE
16491	Firestop Caulk – Red – 10.3 fl. oz. cartridge	EA	12

### Caulk Gun

Caulk guns can be used to hold the sealant to seal duct work.



CATALOG NO.	DESCRIPTION	UOM	ORDER MULTIPLE
7-100	Caulk Gun – Super Ratchet Type	EA	12
7-200	Caulk Gun – Standard Duty	EA	1

### High Temp Red Silicone Sealant

A one part non-slumping paste that cures to a tough, rubbery solid at room temperature. Formulated to perform at temperatures ranging from -85°F to 500°F for continuous operation, and to 600°F for intermittent exposure. Tack free cure time – 15 minutes. Full cure time – 24 hours.

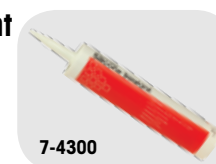

CATALOG NO.	DESCRIPTION	UOM	ORDER MULTIPLE
7-4300	High Temp Red Silicone Sealant – 10.1 oz. Cartridge	EA	12

### Pro-Air Duct Sealant – UL 181 AM-BM Listed

Water-based fiber-reinforced duct sealant/mastic formulated for indoor/outdoor use. Meets U.L. Class 1 rating and local codes while featuring long term flexibility and strength. Use on metal heating, ventilating, and A/C duct systems; as well as fiberglass duct board systems and flex duct systems. Recommended for use to 10" of water column pressure without the need for fiberglass mesh reinforcement.



CATALOG NO.	DESCRIPTION	UOM	ORDER MULTIPLE
800-008	Pro-Air Duct Sealant – 1/10 Gallon Tube – 10.5 oz.	EA	12
800-009	Pro-Air Duct Sealant – 1 Gallon Pail	EA	4

**SEALING COMPOUNDS, ADHESIVE cont'd**

**Pro-Air Industrial Grade Spray Adhesive**

A clear, pressure sensitive aerosol adhesive with exceptional tack and shear strength characteristics. An excellent choice for most permanent adhesive applications: duct liner and wrap, sheet aluminum, fiberglass insulation board, and much more. The aerosol package offers a specially designed web spray pattern for even, controlled distribution. Flammability meets aerosol flame extension test requirements. Coverage is approximately 90-100 square feet per pound.



CATALOG NO.	DESCRIPTION	UOM	ORDER MULTIPLE
<b>GP1-40BL</b>	Pro-Air Spray Adhesive – 38 lb. Disposable Cylinder	EA	1
<b>GN-23H</b>	Spray Gun	EA	1
<b>SH-06</b>	6' Spray Hose	EA	1
<b>SH-12</b>	12' Spray Hose	EA	1

**Black Jack® Roof Cement**

Black Jack® All-Weather Roof Cement is an asphalt based patching compound designed to repair cracks, splits, seams and holes in roofing materials. It also works great in new construction and in setting flashings, drip edges and roofing material edges.

- Use in wet or dry conditions
- Seals flashings, and other roof projections
- Fiber reinforced
- Thick trowel grade



CATALOG NO.	DESCRIPTION	UOM	ORDER MULTIPLE
<b>RM-1G</b>	Black Jack All Weather Roof Cement – 1 gallon	EA	6
<b>RM-10</b>	Black Jack All Weather Roof Cement – 10 oz. tube	EA	12

**SHEET METAL SCREWS**

**Sheet Metal Screw Assortment Kit**

The 7 most popular sizes in one multi-compartmented, resealable, plastic container. Perfect for the toolbox. Contains:

- 7 x 1/2 Taper Point – 175 pieces
- 8 x 1/2 Drill Point – 100 pieces
- 8 x 1 Taper Point – 50 pieces
- 8 x 2 Taper Point – 40 pieces
- 8 x 1/2 Taper Point – 175 pieces
- 8 x 3/4 Taper Point – 60 pieces
- 8 x 1-1/2 Taper Point – 50 pieces
- 1/4" Nut Setter – 1 each



CATALOG NO.	DESCRIPTION	UOM	ORDER MULTIPLE
<b>5-SCR-AK</b>	Sheet Metal Screw Assortment Pack	EA	1

**Masonry Screw**

This product comes in a pack of 250 and is suitable for brick, tile, slate, cement, and cinder block. The screws are a nice addition to the toolbox.



CATALOG NO.	DESCRIPTION	UOM	ORDER MULTIPLE
<b>5-SCRMS</b>	Masonry Screw – 1/4" x 1-1/4", pack of 250	PK	1

**Masonry Bit**

This bit is suitable for brick, tile, slate, cement, and cinder block. This bit is a nice addition to the toolbox.



CATALOG NO.	DESCRIPTION	UOM	ORDER MULTIPLE
<b>540-DB6</b>	Masonry Bit – 3/16" x 6"	EA	1

**Anchor Kit**

Plastic anchor kit for sheet rock applications. Kit includes 100 anchors, screws and 1 masonry bit.



CATALOG NO.	DESCRIPTION	UOM	ORDER MULTIPLE
<b>540-AK100</b>	Anchor size 1/4 x 1, Screw Size 10 x 1-1/4 HWH Head Size 5/16 hex	EA	1

**SHEET METAL SCREWS cont'd**

**Sheet Metal Screws  
– Taper Point**

Hex washer slotted head. Burr-free. Full 1/4" head will not strip out of hex driver opening. Heat treated tapered point will not break or "walk". Packaged in resealable plastic cartons.



**Sheet Metal Screws  
– Drill Point**

Self-drilling, self-tapping. Hex washer head. Produces the optimum hole size, resulting in a tighter fit. Made from special heat treated steel for extra strength. Packaged in resealable plastic cartons.



CATALOG NO.	DESCRIPTION	UOM	ORDER MULTIPLE
5-SCR63-8	6 x 3/8 Taper Point, pack of 1,000	PK	1
5-SCR63-8BULK	6 x 3/8 Taper Point – Bulk, pack of 20,000	PK	1
5-SCR71-2	7 x 1/2 Taper Point, pack of 1,000	PK	1
5-SCR71-2BULK	7 x 1/2 Taper Point – Bulk, pack of 15,000	PK	1
5-SCR81-2	8 x 1/2 Taper Point, pack of 1,000	PK	1
5-SCR81-25M	8 x 1/2 Taper Point, pack of 5,000	PK	1
5-SCR81-2BULK	8 x 1/2 Taper Point – Bulk, pack of 12,000	PK	1
5-SCR83-4	8 x 3/4 Taper Point, pack of 1,000	PK	1
5-SCR83-4BULK	8 x 3/4 Taper Point – Bulk, pack of 10,000	PK	1
5-SCR81	8 x 1 Taper Point, pack of 500	PK	1
5-SCR81BULK	8 x 1 Taper Point – Bulk, pack of 7,500	PK	1
5-SCR81-12-100	8 x 1-1/2 Taper Point, pack of 100	PK	1
5-SCR81-12	8 x 1-1/2 Taper Point, pack of 250	PK	1
5-SCR81-12W	8 x 1-1/2 Taper Point w/White Head, pack of 250	PK	1
5-SCR81-12WTBULK	8 x 1-1/2 Taper Point w/White Head – Bulk, pack of 5,000	PK	1
5-SCR81-12BULK	8 x 1-1/2 Taper Point – Bulk, pack of 5,000	PK	1
5-SCR82-100	8 x 2 Taper Point, pack of 100	PK	1
5-SCR82	8 x 2 Taper Point, pack of 350	PK	1
5-SCR82W	8 x 2 Taper Point w/White Head, pack of 250	PK	1
5-SCR82BULK	8 x 2 Taper Point – Bulk, pack of 3,000	PK	1
5-SCR101-2	10 x 1/2 Taper Point, pack of 1,000	PK	1
5-SCR101-2BULK	10 x 1/2 Taper Point – Bulk, pack of 14,000	PK	1
5-SCR103-4	10 x 3/4 Taper Point, pack of 1,000	PK	1
5-SCR103-4BULK	10 x 3/4 Taper Point – Bulk, pack of 10,000	PK	1
5-SCR101	10 x 1 Taper Point, pack of 500	PK	1
5-SCR101BULK	10 x 1 Taper Point – Bulk, pack of 7,000	PK	1

CATALOG NO.	DESCRIPTION	HEAD SIZE	UOM	ORDER MULTIPLE
5-SCR61-2DP	6 x 1/2 Drill Point, pack of 1,000	1/4"	PK	1
5-SCR61-2DPBULK	6 x 1/2 Drill Point – Bulk, pack of 15,000	1/4"	PK	1
5-SCR81-2DP	8 x 1/2 Drill Point, pack of 1,000	1/4"	PK	1
5-SCR81-2DPBULK	8 x 1/2 Drill Point – Bulk, pack of 10,000	1/4"	PK	1
5-SCR83-4DP	8 x 3/4 Drill Point, pack of 500	1/4"	PK	1
5-SCR83-4DPBULK	8 x 3/4 Drill Point – Bulk, pack of 10,000	1/4"	PK	1
5-SCR81DP	8 x 1 Drill Point, pack of 500	1/4"	PK	1
5-SCR81DPBULK	8 x 1 Drill Point – Bulk, pack of 7,500	1/4"	PK	1
5-SCR81-12DP	8 x 1-1/2 Drill Point, pack of 500	1/4"	PK	1
5-SCR81-12DPBULK	8 x 1-1/2 Drill Point – Bulk, pack of 5,000	1/4"	PK	1
5-SCR82DP	8 x 2 Drill Point, pack of 350	1/4"	PK	1
5-SCR82DPBULK	8 x 2 Drill Point – Bulk, pack of 2,500	1/4"	PK	1
5-SCR101-2DP	10 x 1/2 Drill Point, pack of 500	5/16"	PK	1
5-SCR101-2DPBULK	10 x 1/2 Drill Point – Bulk, pack of 10,000	5/16"	PK	1
5-SCR103-4DP	10 x 3/4 Drill Point, pack of 500	5/16"	PK	1
5-SCR103-4DPBULK	10 x 3/4 Drill Point – Bulk, pack of 5,000	5/16"	PK	1
5-SCR101DP	10 x 1 Drill Point, pack of 500	5/16"	PK	1
5-SCR101DPBULK	10 x 1 Drill Point – Bulk, pack of 5,000	5/16"	PK	1
5-SCR101-12DP	10 x 1-1/2 Drill Point, pack of 250	5/16"	PK	1
5-SCR101-12DPBULK	10 x 1-1/2 Drill Point – Bulk, pack of 3,500	5/16"	PK	1
5-SCR102DP	10 x 2 Drill Point, pack of 350	5/16"	PK	1
5-SCR102DPBULK	10 x 2 Drill Point – Bulk, pack of 2,500	5/16"	PK	1

**WASP, HORNET, AND YELLOW JACKET KILLERS**

**Sting Less Wasp & Hornet Killer**

Kills wasps, hornets and yellow jackets. Very fast-acting when insects are hit directly. Allow approximately 24 hours for those that were not directly hit. This container delivers a 20-foot jet blast to knock down the insects and allow for the user to remain at a safe distance.



CATALOG NO.	DESCRIPTION	UOM	ORDER MULTIPLE
436-20	Sting Less Wasp & Hornet Spray – 14 oz. Aerosol	EA	12

**Wasp & Hornet Killer by ENFORCER.**

Enforcer's Wasp & Hornet Killer shoots a 20-foot jet blast for instant knockdown of wasps, hornets, and yellow jackets. Enforcer's Wasp & Yellow Jacket Foam is a 20-foot blast of blanketing foam that plugs yellow jacket holes and clings to wasp and hornet nests, preventing their escape.



CATALOG NO.	DESCRIPTION	UOM	ORDER MULTIPLE
8-WH16	Enforcer Wasp & Hornet Killer – 16 oz. Aerosol	EA	12
8-FWH16	Enforcer Wasp & Yellow Jacket Foam – 16 oz. Aerosol	EA	12



Anchors.....	101-102
Boxes, Rings, and Covers.....	103-104
Bulbs .....	104
Cable Connectors .....	105
Cable Ties and Accessories .....	106
Conduit Fittings .....	107
General Tools.....	108
High Temperature Solderless Terminals .....	99
Nuts and Bolts.....	108-109
Plastic Anchor Kits .....	102
Power Cords and Work Lights .....	110
Screws .....	110
Slip-On Solderless Terminals .....	94-95
Special Purpose Solderless Terminals .....	95-96
Specialty Fasteners.....	111
Specialty Fittings .....	112
Specialty Tools.....	112
Standard Solderless Terminals .....	96-98
Storage Containers .....	112
Tapes .....	113
Terminal Kits .....	100
Testers, Leads, Clips .....	113
Waterproof Solderless Terminals.....	98
Wire.....	114
Wiring Devices .....	115-119



# How to sell DEVCO products

*DEVCO merchandising displays are an easy and attractive way to showcase a variety of DEVCO products in your store. Offered in three different versions, each display rack includes everything you need to create extra sales for your business.*





## Easy to Display

DEVCO provides turnkey merchandising solutions for wholesale distribution. Attractive, easy to set-up merchandising displays provide a great way to highlight DEVCO products and make it easy for customers to find what they need. The point of sale display merchandises the products, enabling the distributor to add additional sales.

The products merchandised on the carousel are impulse buy items. The items are packed so they cost the contractor only a few dollars, and most are less than \$10 each.

## Easy to Profit

DEVCO displays provide a typical distributor branch with easy add-on sales that build profits. Each display can generate significant sales and margins for the store while providing contractors with the parts they need to finish the job. These self-service displays are a great way to increase revenue with minimal effort.

## The Perfect Plan

Each DEVCO Merchandising display comes with a complete plan-o-gram to make merchandising it simple and fast. And there are three different versions available so you can choose the display that's right for your business and customers.

And when you purchase the DEVCO products to fill it up, the merchandising rack is **loaned free of charge**.

Display Rack	Featured Products
<b>EZC</b>	Solderless terminals, ground connectors, fasteners, anchor kits, cable ties, washers, hex nuts, cable clamps, sheet metal screws and hose clamps
<b>Electrical</b>	Ground adaptors, outlets, boxes, bushings, cable connectors, extension rings, indicator lights, plugs and connectors, receptacles, reducing washers, toggle switches and hook up wire
<b>Combo</b>	Solderless terminals, insulated rings, ground adaptors, covers, reducing washers, plugs and connectors, hook up wire, fasteners, hex nuts and self drilling screws



# PLAN-O-GRAM FOR DEVCO ELEC RACK (MKT-POP-DEVELEC)

DEVCO

### PANEL A

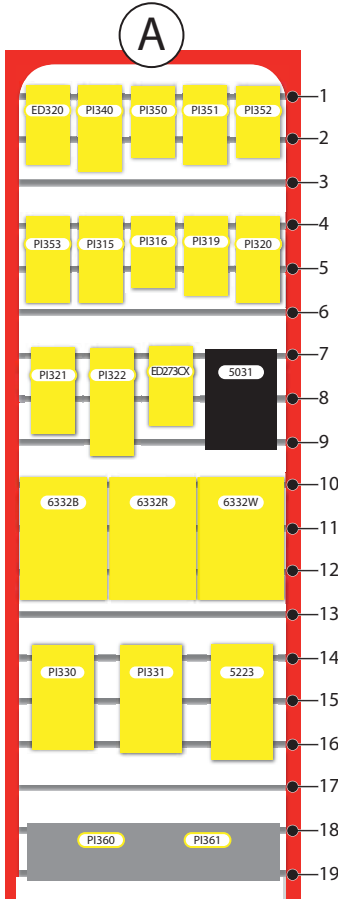

### PANEL B

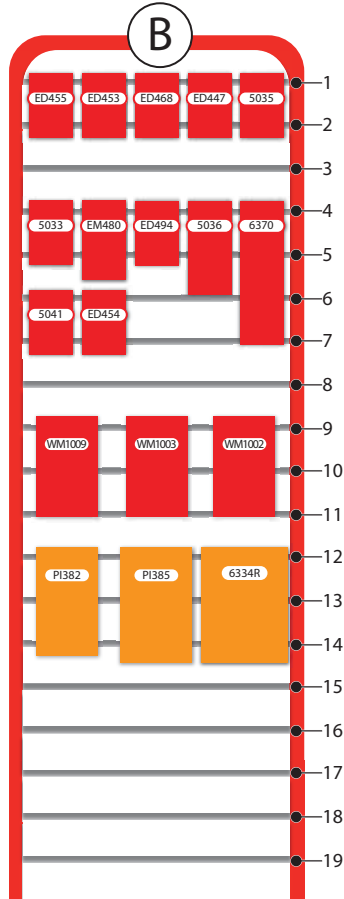

### PANEL C

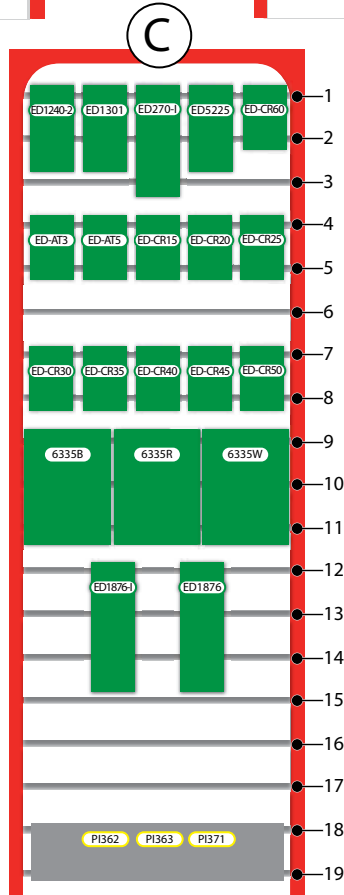

### PANEL D

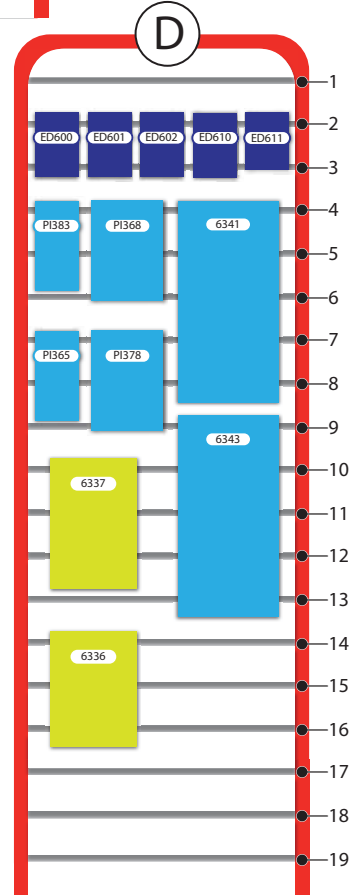

### MKT-POP-DEVELEC

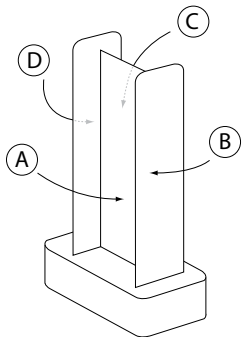

### MKT-POP-DEVELEC Merchandising Rack 72" x 22" x 20.5"



# PLAN-O-GRAM FOR DEVCO EZC RACK (MKT-POP-DEVEZC)

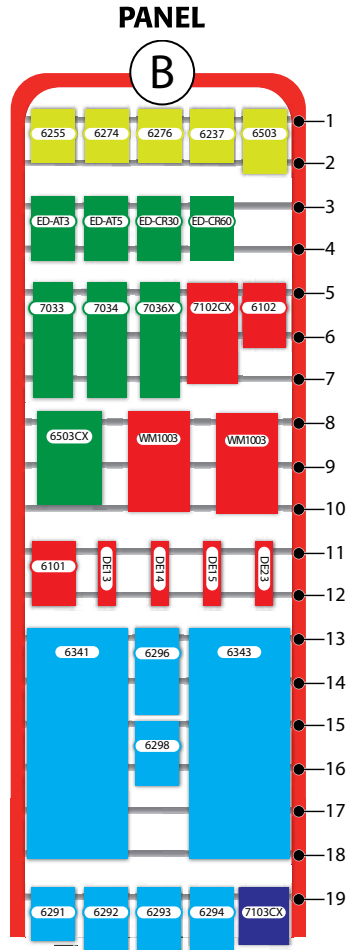
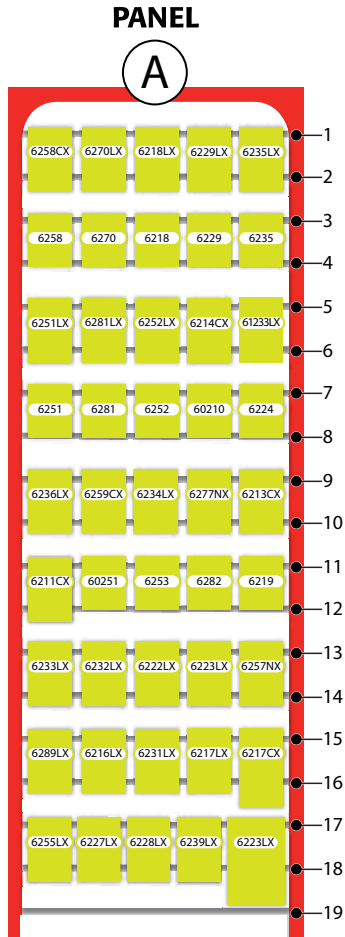

MKT-POP-DEVEZC

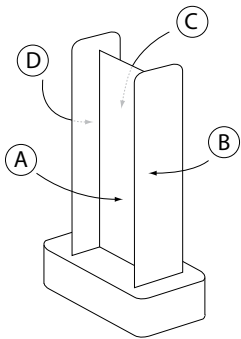
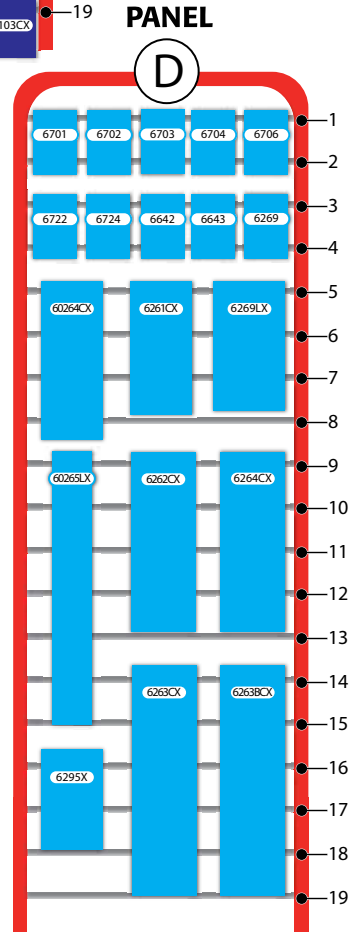
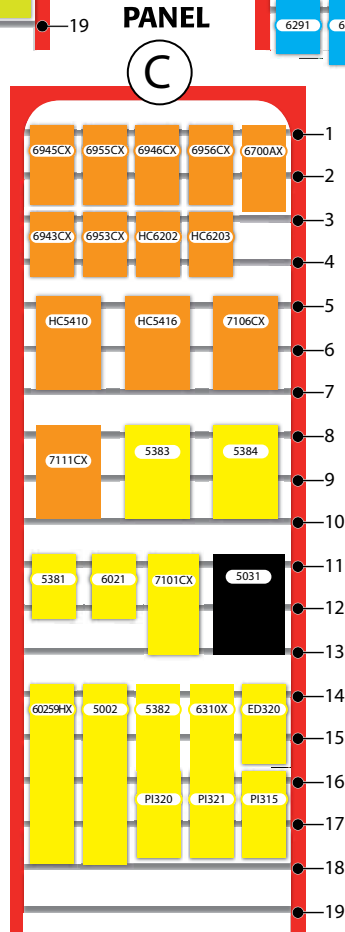

MKT-POP-DEVEZC  
Merchandising Rack  
72" x 22" x 20.5"



# PLAN-O-GRAM FOR DEVCO COMBO RACK (MKT-POP-DEVCOMBO)

### PANEL A

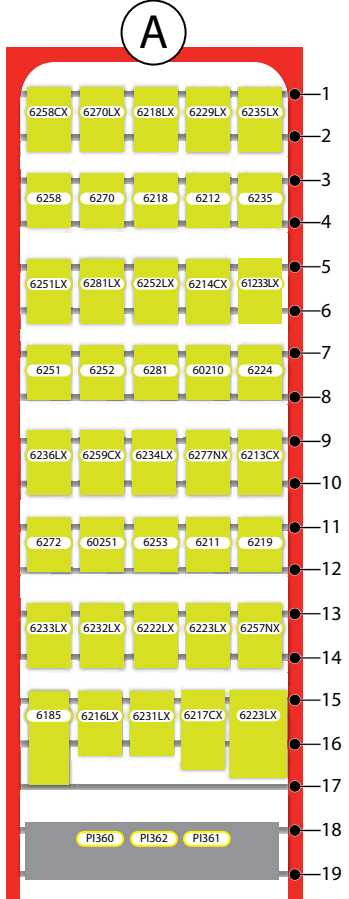

### PANEL B

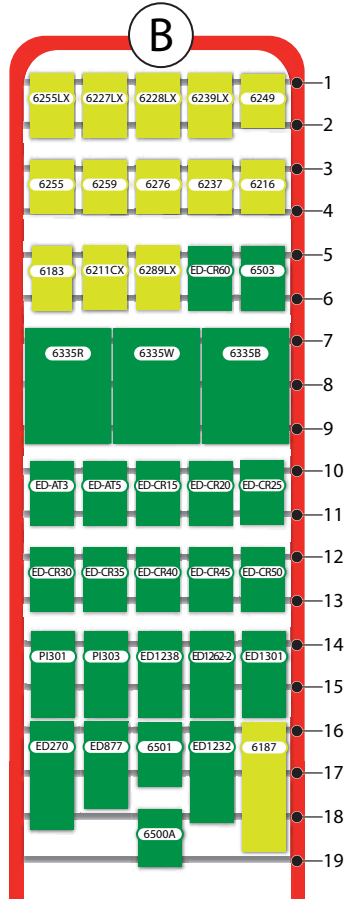

### MKT-POP-DEVCOMBO

### PANEL C

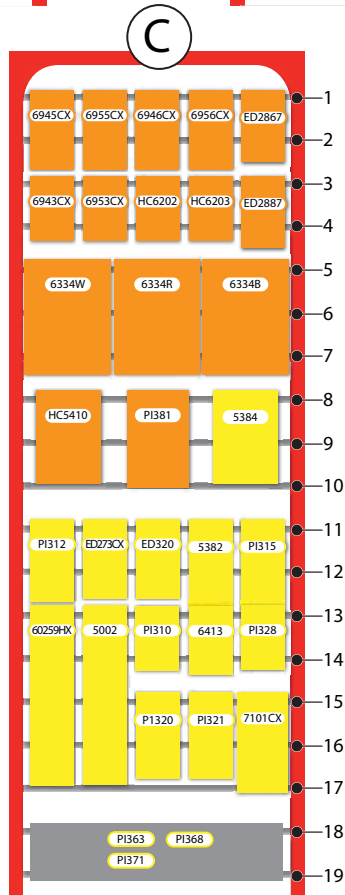

### PANEL D

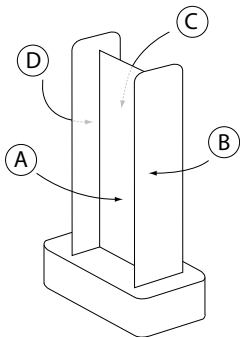
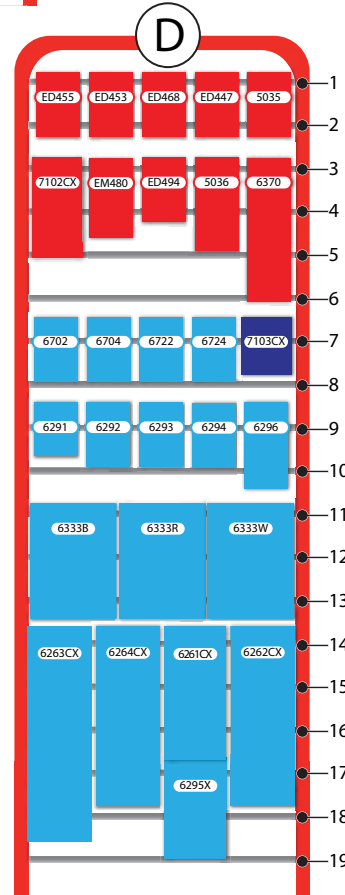

### MKT-POP-DEVCOMBO Merchandising Rack 72" x 22" x 20.5"

**PLAN-O-GRAM FOR DEVCO PB-16 RACK (MKT-POP-DEV16)**

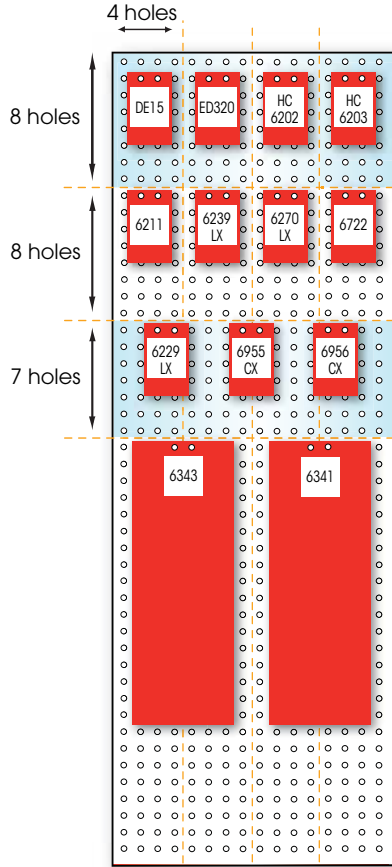
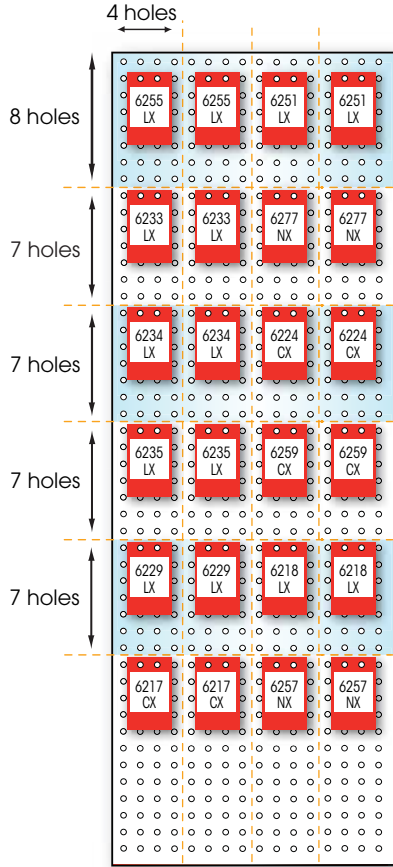

MKT-POP-DEV16

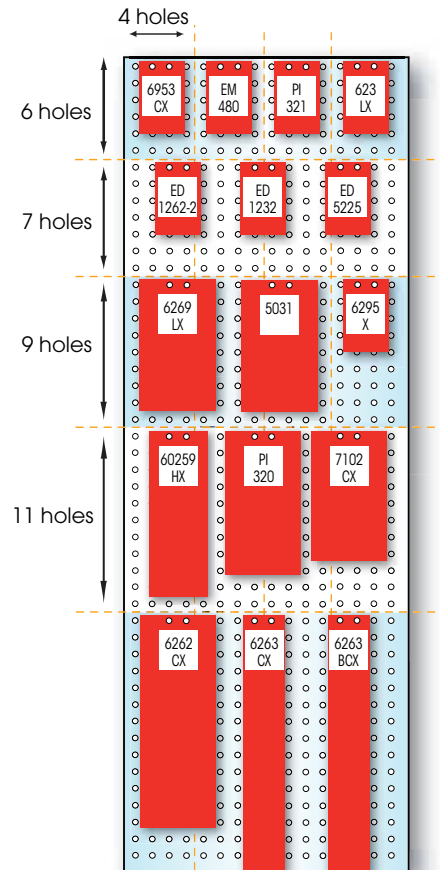
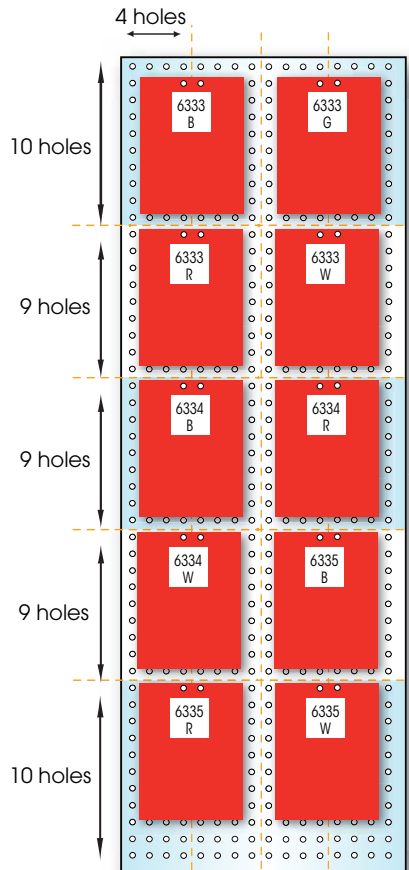



## DEVCO RACKS MASTER ITEM LIST (BY RACK)

This DEVCO product list includes any DEVCO item that is part of the plan-o-gram display for either the EZC, ELEC, COMBO, or PB-16 versions of the DEVCO rack. This cross reference indicates on which display rack each item should be placed.

ITEM #	ITEM DESCRIPTION	ELEC	EZC	COMBO	PB-16	ITEM #	ITEM DESCRIPTION	ELEC	EZC	COMBO	PB-16
5002	Crimp Tool w/ Cutter & Stripper Ins.		X	X		6703	Flat Washer 5/16in Uss zn Pltd.		X		
5031	Test Leads (ins. Alligator clips) Low Voltage 22in 8pcs	X	X		X	6704	Flat Washer 3/8in Uss zn Pltd.		X	X	
5033	Alligator Clips (steel) 2in long for probes .075in-.08in	X				6706	Flat Washer 1/2in Uss zn Pltd.		X		
5035	Alligator Clips (copper) B&R Ins 2in long	X		X		6722	Fender Washer 1/4in zn Pltd.	X	X	X	
5036	Test Clip (steel 20A) B&R Insulators 2-7/16in long	X		X		6724	Fender Washer 3/8in zn Pltd.	X	X		
5041	Test Leads Low Voltage Hook Ty22ga 36in red & black	X				7033	Toggle Bolt w/wing 3/16inx4inzn Pltd.	X			
5223	Triple Outlet 2 Pole 3 Wire 15A-125V Polarized plastic	X				7034	Toggle Bolt w/wing 1/4inx4in zn Pltd.	X			
5381	Nylon Cable Clamp 1/8in I.D.		X			60210	Tab Ad. Ins. .250 16-14 multi stack male & female	X	X		
5382	Nylon Cable Clamp 1/4in I.D.		X	X		60251	Slip-On F 12-10 Non-Ins. .250	X	X		
5383	Nylon Cable Clamp 3/8in I.D.		X			60259HX	Comp. Lead Kt 12in 10ga wire	X	X	X	
5384	Nylon Cable Clamp 1/2in I.D.		X	X		60264CX	Cable Tie 6in w/ #8 Hole 30# 1-3/8in B. Dia nat 100/PK	X			
6021	Rnd Head Screw #6 8 10-32 x 1/2in 1-1/2in) zn Pltd.		X			60265LX	Cable Tie 14in 50# 4in B. Dia natural 50 pcs	X			
6101	Motor Shaft Keys (1/8in 3/16in 1/4in 3/16in x 1/4in) zn Pltd.		X			61233LX	Slip-on M & F 16-14 .250 Full Ins Nylon 50 pcs	X	X		
6102	Motor Shaft Keys (1/4insq 5/16insq 3/8insq) zn Pltd.		X			6211CX	Tab Ad. S. F Dbl M Non-Ins. 100 pcs	X	X		
6183	Terminal Block 20A-250V 6 pos			X		6213CX	Flag F QD 16-14 Non-Ins. .250 100 pcs	X	X		
6185	Terminal Block 20A-250V 10 pos			X		6214CX	Slip-on F 16-14 Non-Ins. .250 100 pcs	X	X		
6187	Terminal Block 20A-250V 14 pos			X		6216LX	Ring 16-14 Ins. #10 Stud 50 pcs	X	X		
6211	Tab Ad. S. F Dbl M. .250 Non-Ins.			X	X	6217CX	Buff Conn. 16-14 Ins. 100 pcs	X	X	X	
6212	Dbl. M. Tab Ad. S. F. Non-Ins.			X		6217LX	Buff Conn. 16-14 Ins. 50 pcs	X	X		
6216	Ring 16-14 Ins. #10 Stud			X		6218LX	Slip-on F 16-14 Ins. .250 50 pcs	X	X	X	
6218	Slip-on F 16-14 Ins. .250	X	X			6222LX	Dead End Conn. 22-14 Fully Ins. 50 pcs	X	X		
6219	Slip-on M 16-14 Ins. .250	X	X			6223LX	Dead End Conn. 18-10 Fully Ins. 50 pcs	X	X		
6224	Flag F QD 12-10 Non-Ins. .250	X	X	X		6227LX	Spade 16-14 Ins. #8 Stud	X	X		
6229	Slip-on F 16-14 Full Ins. .250	X				6228LX	Spade 16-14 Ins. #10 Stud 50 pcs	X	X		
6235	Slip-on F 22-18 Ins. .250	X	X			6229LX	Slip-on F 16-14 Full Ins. .250	X	X	X	
6237	Spade 22-18 Ins. #8 Stud	X	X			6231LX	Buff Conn. 12-10 Ins. 50 pcs	X	X		
6249	M Tab 1 pair bent 90 Non-Ins.			X		6232LX	Buff Conn. 22-18 Ins. 50 pcs	X	X		
6251	Slip-on F 12-10 Ins. .250	X	X			6233LX	Slip-on F 16-14 .250 Full Ins. Nylon 50 pcs	X	X	X	
6252	Ring 12-10 Ins. #10 Stud	X	X			6234LX	Slip-on M 16-14 .250 Full Ins. Nylon 50 pcs	X	X	X	
6253	Ring 12-10 Ins. 1/4in Stud	X	X			6235LX	Slip-on F 22-18 Ins. .250 50 pcs	X	X	X	
6255	Spade 12-10 Ins. #10 Stud	X	X			6236LX	Ring 22-18 Ins. #8 Stud 50 pcs	X	X		
6258	Comp. Flag F. 16-14 Non-Ins. .250	X	X			6239LX	Spr. Spade 16-14 Ins. #8 Stud	X	X	X	
6259	Comp. Flag F. 12-10 Non-Ins. .250			X		6251LX	Slip-on F 12-10 Ins. .250	X	X	X	
6269	Cable Tie Mount	X				6252LX	Ring 12-10 Ins. #10 Stud	X	X		
6270	Comp. Flag F. 12-8 Non-Ins. .250	X	X			6255LX	Spade 12-10 Ins. #10 Stud 50 pcs	X	X	X	
6272	Ring 16-14 Ins. #6 Stud			X		6257NX	Ring #8 Ins. 1/4in Stud 25 pc	X	X	X	
6274	Spade 16-14 Ins. #6 Stud	X				6258CX	Comp. Flag F. 16-14 Non-Ins. .250 100 pcs	X	X		
6276	Spr. Spade 16-14 Ins. #6 Stud	X	X			6259CX	Comp. Flag F. 12-10 Non-Ins. .250 100 pcs	X	X	X	
6281	Slip-on F 16-14 Ins. .187	X	X			6261CX	Cable Tie 6in 18# 1-3/8in B. Dia natural 100 pcs	X	X		
6282	Slip-on F 22-18 Ins. .187	X				6262CX	Cable Tie 7-1/2in 50# 1-3/4in B. Dia natural 100 pcs	X	X	X	
6291	Wire Connector Mini-Gray	X	X			6263CX	Cable Tie 11in 50# 3in B. Dia natural 100 pcs	X	X	X	
6292	Wire Connector Tiny-Blue	X	X			6263BCX	Cable Tie 11in 50# 3in B. Dia black 100 pcs	X		X	
6293	Wire Connector Small-Orange	X	X			6264CX	Cable Tie 7in w/ #10 Hole 50# 1-3/4in B. Dia nat 100/PK	X	X		
6294	Wire Connector Medium-Yellow	X	X			6269LX	Cable Tie Mount 50 pcs	X		X	
6296	Wire Connector Large-Red	X	X			6270LX	Comp. Flag F. 12-8 Non-Ins. .250 50 pcs	X	X	X	
6298	Wire Connector XLarge-Gray	X				6277NX	Flag F QD 16-14 .250 Fully Ins. Nylon 25 pcs	X	X	X	
6336	Thermostat Wire 3 Conduct. 40 ft.	X				6281LX	Slip-on F 16-14 Ins. .187 50 pcs	X	X		
6337	Thermostat Wire 5 Conduct. 40 ft.	X				6289LX	Bullet Plug & Rec. 16-14 Ins. 50 pcs	X	X		
6341	SJTO Service Cord 16 GA 20 ft.	X	X		X	6295X	Assorted Wire Connectors	X	X	X	
6343	SJTO Service Cord 14 GA 20 ft.	X	X		X	6310X	Grease Fitting Assortment box	X			
6370	Heat Shrink Tubing Assort. B&W 1/8in & 1/4in supplied 6in	X		X		6332B	Hook-up Wire 16ga blk. 48 ft	X			
6413	Fin. Hex Nut 1/4in-20 zn Pltd.			X		6332R	Hook-up Wire 16ga red. 48 ft	X			
6501	Fin. Hex Nut 1/4in-20 zn Pltd.		X	X		6332W	Hook-up Wire 16ga wht. 48 ft	X			
6503	Fin. Hex Nut 3/8in-16 zn Pltd.		X	X		6333B	Hook-up Wire 14ga blk. 48 ft			X	X
6642	HH Cap Screw 3/8in-16 x 1in		X			6333G	Hook-up Wire 14ga gm. 48 ft				X
6643	HH Cap Screw 3/8in-16 x 1 1/2in		X			6333R	Hook-up Wire 14ga red. 48 ft			X	X
6701	Flat Washer 3/16in Uss zn Pltd.		X			6333W	Hook-up Wire 14ga wht. 48 ft			X	X
6702	Flat Washer 1/4in Uss zn Pltd.		X	X		6334B	Hook-up Wire 12ga blk. 48 ft			X	X

continued

**DEVCO RACKS MASTER ITEM LIST (BY RACK) cont'd**

ITEM #	ITEM DESCRIPTION	ELEC	EZC	COMBO	PB-16
6334R	Hook-up Wire 12ga red 48 ft	X		X	X
6334W	Hook-up Wire 12ga wht. 48 ft			X	X
6335B	Hook-up Wire 10ga blk. 48 ft	X		X	X
6335R	Hook-up Wire 10ga red 48 ft	X		X	X
6335W	Hook-up Wire 10ga wht. 48 ft	X		X	X
6500A	Asst Mach. Screw Hex Nuts 6-32 8-32 10-32 zn Pltd.			X	
6503CX	Fin. Hex Nut 3/8in-16 zn Pltd. 100 pcs		X		
6700AX	Flat Washer Assortment Pack 3/16 1/4 5/16 3/8 1/2 5/8 inch		X		
6943CX	Self Drilling Screw #8x1/2in 1/4in Hex Head zn Pltd. 100/PK	X	X		
6945CX	Self Drilling Screw #8x3/4in 1/4in Hex Head zn Pltd. 100/PK	X	X		
6946CX	Self Drilling Screw #8x1in 1/4in Hex Head zn Pltd. 100/PK	X	X		
6953CX	Drill Tip Screw #10x1/2in 5/16in Hex Head 100/PK	X	X	X	
6955CX	Drill Tip Screw #10x3/4in 5/16in Hex Head 100/PK	X	X	X	
6956CX	Self Drilling Screw #10x1in 5/16in Hex Head zn Pltd. 100/PK	X	X	X	
7036X	Toggle Bolt w/wing 3/8inx4in zn Pltd.		X		
7101CX	Anch Kit Yellow #8x1in w 3/16in bit 100 s + 100 a		X	X	
7102CX	Anch Kit Red #10x1-1/4in w 1/4in bit 100 s + 100 a		X	X	X
7103CX	Anch Kit Blue #4x3/4in w 5/32in bit 100 s + 100 a		X	X	
7106CX	Plug Anchor Kit Green #10x1in 1/4in bit 100 s +100 a bag		X		
7111CX	Plug Anchor Kit Blue #14x1in w 5/16in bit 100 s +100 a bag		X		
DE13	Magnetic Hex Chuck 1/4in x 1-3/4in		X		
DE14	Magnetic Hex Chuck 5/16in x 1-3/4in		X		
DE15	Magnetic Hex Chuck 3/8in x 1-7/8 in		X	X	
DE23	Magnetic Hex Chuck 1/4in x 2-9/16 in		X		
ED1232	Toggle Switch D.P. 30A-120/277V brown			X	X
ED1238	Toggle Switch S.P. 20A-120/277V brown			X	
ED1240-2	Toggle Switch S.P. 15A-120/277V brown	X			
ED1262-2	Toggle Switch D.P. 15A-120/277V brown			X	X
ED1301	Toggle Switch S.P. 15A-120V brown	X		X	
ED1876	Single Receptacle 20A-250V 2 pl. 3 wr. brown	X			
ED1876-1	Single Receptacle 20A-250V 2 pl. 3 wr. ivory	X			
ED270	Duplex Receptacle 15A-125V 2 pl. 3 wr. brown			X	
ED270-1	Duplex Receptacle 15A-125V 2 pl. 3 wr. ivory	X			
ED273CX	Electrical Staple insul size #5 5/8in x 1/4in 100/PK	X		X	
ED2867	Armored Plug 15A-125V 2pl.3 wr. vinyl enclosed			X	
ED2887	Armored Connector 15A-125V 2pl. 3 wr. vinyl enclosed			X	
ED320	Vinyl Grommet Asst. contains: ED300 thru ED316	X	X	X	X
ED447	Bat Handle Switch metal SPST on-off 10A/277V-20A/125V AC	X		X	
ED453	Bat Handle Switch metal DPDT on-on 10A/277V-20A/125V AC	X		X	
ED454	Bat Handle Switch metal SPDT on-on 10A/277V-20A/125V AC	X			
ED455	Bat Handle Switch metal DPST on-off 10A/277V-20A/125V AC	X		X	
ED468	Bat Handle Switch metal SPDT on-off-on 10A/277V-20A/125V	X		X	
ED494	Bat Handle Switch metal DPDT on-off-on 10A/277V-20A/125V	X		X	
ED5225	Switch & Receptacle 2p 3w (sw:15A-120VAC& rec:15A-125VAC) brn	X			X
ED600	Indicator Light 28V red PC lens incandescent bulb	X			
ED601	Indicator Light 28V green PC lens incandescent bulb	X			
ED602	Indicator Light 28V amber PC lens incandescent bulb	X			
ED610	Indicator Light 105-125V AC red nylon lens neon bulb	X			
ED611	Indicator Light 105-125V AC grn PC lensneon blb-G2B Imp&resstr	X			
ED877	Duplex Receptacle 20A-125V 2 pl. 3 wr. brown			X	
EM480	In-Line Fuse Holder 1-1/4 x 1/4in fuses to 20A/32V 14ga	X		X	X
HC5410	Hose Clamp 9/16in-1-1/8in SShousing&band st hex screw		X	X	
HC5416	Hose Clamp 3/4in-1-1/2in SShousing&band st hex screw		X		
HC6202	Hose Clamp 1/4in-5/8in SS housing&band st hex screw		X	X	X
HC6203	Hose Clamp 5/16in-7/8in SShousing&band st hex screw		X	X	X

ITEM #	ITEM DESCRIPTION	ELEC	EZC	COMBO	PB-16
PI301	Cond Nip 1/2in offset zn w pltd. stl locknuts insul. bushings			X	
PI303	Cond Nip 1/2in strt galv steel w pltd. stl lock insul.			X	
PI310	Reduc. Wash 3/4in to 1/2in Rsd Fln Galv St			X	
PI312	BX Conct set screw 3/8in Tr. 1/2in KO. zn die cast			X	
PI315	BX Connector 90 3/8inTr. 1/2in KO zn die cast	X	X	X	
PI316	Knockout Seal for 1/2in KO zn Pltd. steel	X			
PI319	Romex Connector 3/4in Tr. 3/4in KO. zn Pltd. die cast	X			
PI320	Romex Connector 3/8in Tr. 1/2in KO. zn Pltd. die cast 25/PK	X	X	X	X
PI321	Romex Connector 3/8in Tr. 1/2 in KO. zn Pltd. die cast	X	X	X	X
PI322	BX Conct str sqze 3/8in Tr. 1/2in KO. zn die cast	X			
PI328	Split Bolt Connector Cu use (6 max sol & 7 max strnd)			X	
PI330	Romex Stap plastic 3/8inx1/2in for 2 cond. romex 12/2-14/2	X			
PI331	Plastic in Anti-Shortin Bush 14/2 14/3 & 12/2 BX cable	X			
PI340	Combo Cable Connector for romex & BX 3/8in Tr. 1/2in KO	X			
PI350	Metal LT Conn straight 1/2in Tr. 1/2in K.O.	X			
PI351	Metal LT Conn straight 3/4in Tr. 3/4in K.O.	X			
PI352	Liquid Tight Connector 90 1/2in Tr. 1/2in K.O. zn die cast	X			
PI353	Liquid Tight Connector 90 3/4in Tr. 3/4in K.O. zn die cast	X			
PI360	Box galv. steel 4in x 2-1/8inx 1-7/8in 1/2in KO 13 in3	X		X	
PI361	Box galv. steel 4in x 2-1/8inx 2-1/8in 1/2in KO 14.5 in3	X		X	
PI362	1900 Box galv. steel 4X4X1-1/2 1/2&3/4 KO 21 in3	X		X	
PI363	1900 Box galv. steel 4X4X2-1/8in 1/2&3/4 KO 30.3 in3	X		X	
PI365	Utility Cover Toggle Switch 2-11/32in x 4-1/4in Pltd. steel	X			
PI368	1900 Cover Sw/Dup Rec cad fin. steel 4in x 4in raised 1/2in	X		X	
PI371	1900 Cover Blank Flat galv. steel	X		X	
PI378	1900 Cover Duplex Recep cadil fin. steel 4X4 raised 1/2in	X			
PI381	Fuse Outlet & Switch w cover 1/2HP-125V AC galv. steel			X	
PI382	Weatherproof Cover Blank Al 1 Gang w gasket anodized	X			
PI385	Wthprf Box AL2-3/4inx4-1/2inx23 1/2in holes 2 plugs 19 in3	X			
WM1002	Cable Marker Book alpha numer	X			
WM1003	Cable Marker Book numeric contains 10 each: 1 - 45	X	X		
WM1009	Cable Marker Book line & term	X			
ED-AT3	Blade Fuses - 3 Amp - Purple, Pack of 10	X	X	X	
ED-AT5	Blade Fuses - 5 Amp - Tan, Pack of 10	X	X	X	
ED-CR15	Dual Element Fuses - 15 Amp, Pack of 2	X		X	
ED-CR20	Dual Element Fuses - 20 Amp, Pack of 2	X		X	
ED-CR25	Dual Element Fuses - 25 Amp, Pack of 2	X		X	
ED-CR30	Dual Element Fuses - 30 Amp, Pack of 2	X	X	X	
ED-CR35	Dual Element Fuses - 35 Amp, Pack of 2	X		X	
ED-CR40	Dual Element Fuses - 40 Amp, Pack of 2	X		X	
ED-CR45	Dual Element Fuses - 45 Amp, Pack of 2	X		X	
ED-CR50	Dual Element Fuses - 50 Amp, Pack of 2	X		X	
ED-CR60	Dual Element Fuses - 60 Amp, Pack of 2	X	X	X	

**SLIP-ON SOLDERLESS TERMINALS****Insulated Male Slip-Ons**

These male terminals crimp to the wires which relieves the need to solder. A variety of sizes are available and the slip ons are fully insulated in either vinyl or nylon.

**60219**

CATALOG NO.	DESCRIPTION	WIRE RANGE	TAB SIZE	UOM	ORDER MULTIPLE
<b>60219</b>	Insulated Male Slip-On, pack of 23	22-18	.250	PK	1
<b>60219LX</b>	Insulated Male Slip-On, pack of 50	22-18	.250	PK	1
<b>60220</b>	Insulated Male Slip-On, pack of 23	16-14	.187	PK	1
<b>60220LX</b>	Insulated Male Slip-On, pack of 50	16-14	.187	PK	1
<b>6219</b>	Insulated Male Slip-On, pack of 22	16-14	.250	PK	1
<b>6219LX</b>	Insulated Male Slip-On, pack of 50	16-14	.250	PK	1
<b>61221LX</b>	Insulated Male Slip-On, pack of 50	12-10	.250	PK	1
<b>61221CX</b>	Insulated Male Slip-On, pack of 100	12-10	.250	PK	1

**Insulated Female Slip-Ons**

These female terminals crimp to the wires which relieves the need to solder. A variety of sizes are available and the slip ons are fully insulated in either vinyl or nylon.

**6282**

CATALOG NO.	DESCRIPTION	WIRE RANGE	TAB SIZE	UOM	ORDER MULTIPLE
<b>6282</b>	Insulated Female Slip-On, pack of 22	22-18	.187	PK	1
<b>6282LX</b>	Insulated Female Slip-On, pack of 50	22-18	.187	PK	1
<b>6235</b>	Insulated Female Slip-On, pack of 22	22-18	.250	PK	1
<b>6235LX</b>	Insulated Female Slip-On, pack of 50	22-18	.250	PK	1
<b>6235CX</b>	Insulated Female Slip-On, pack of 100	22-18	.250	PK	1
<b>6281</b>	Insulated Female Slip-On, pack of 22	16-14	.187	PK	1
<b>6281LX</b>	Insulated Female Slip-On, pack of 50	16-14	.187	PK	1
<b>6218</b>	Insulated Female Slip-On, pack of 22	16-14	.250	PK	1
<b>6218LX</b>	Insulated Female Slip-On, pack of 50	16-14	.250	PK	1
<b>6218CX</b>	Insulated Female Slip-On, pack of 100	16-14	.250	PK	1
<b>6251</b>	Insulated Female Slip-On, pack of 17	12-10	.250	PK	1
<b>6251LX</b>	Insulated Female Slip-On, pack of 50	12-10	.250	PK	1
<b>6251CX</b>	Insulated Female Slip-On, pack of 100	12-10	.250	PK	1
<b>61223LX</b>	Insulated Female Slip-On, pack of 50	12-10	.340	PK	1

**Fully Insulated Female Slip-Ons**

These female terminals crimp to the wires which relieves the need to solder. A variety of sizes are available and the slip ons are fully insulated in either vinyl or nylon. This terminal features insulation grip. This terminal is usually supplied vinyl and has an insulation grip.

**6229**

CATALOG NO.	DESCRIPTION	WIRE RANGE	TAB SIZE	UOM	ORDER MULTIPLE
<b>6229**</b>	Fully Insulated Female Slip-On, pack of 11	16-14	.250	PK	1
<b>6229LX**</b>	Fully Insulated Female Slip-On, pack of 50	16-14	.250	PK	1
<b>6233</b>	Fully Insulated Female Slip-On, pack of 14	16-14	.250	PK	1
<b>6233LX</b>	Fully Insulated Female Slip-On, pack of 50	16-14	.250	PK	1
<b>6233CX</b>	Fully Insulated Female Slip-On, pack of 100	16-14	.250	PK	1
<b>61234LX</b>	Fully Insulated Female Slip-On, pack of 50	12-10	.250	PK	1

\* This terminal features insulation grip.

\*\* This terminal is usually supplied vinyl and has an insulation grip.

**Non-Insulated Male Slip-Ons**

These non insulated male terminals crimp to the wires which relieves the need to solder. A variety of sizes are available

**6220**

CATALOG NO.	DESCRIPTION	WIRE RANGE	TAB SIZE	UOM	ORDER MULTIPLE
<b>61219</b>	Non-Insulated Male Slip-On, pack of 37	22-18	.250	PK	1
<b>61220</b>	Non-Insulated Male Slip-On, pack of 37	16-14	.187	PK	1
<b>6220</b>	Non-Insulated Male Slip-On, pack of 38	16-14	.250	PK	1
<b>6220CX</b>	Non-Insulated Male Slip-On, pack of 100	16-14	.250	PK	1
<b>61222</b>	Non-Insulated Male Slip-On, pack of 27	12-10	.250	PK	1
<b>61222CX</b>	Non-Insulated Male Slip-On, pack of 100	12-10	.250	PK	1

**Non-Insulated Female Slip-Ons**

These non insulated female terminals crimp to the wires which relieves the need to solder. A variety of sizes are available. This terminal features insulation grip.

**6214**

CATALOG NO.	DESCRIPTION	WIRE RANGE	TAB SIZE	UOM	ORDER MULTIPLE
<b>60235</b>	Non-Insulated Female Slip-On, pack of 36	22-18	.110	PK	1
<b>6221CX</b>	Non-Insulated Female Slip-On, pack of 100	16-14	.187	PK	1
<b>6214</b>	Non-Insulated Female Slip-On, pack of 35	16-14	.250	PK	1
<b>6214CX</b>	Non-Insulated Female Slip-On, pack of 100	16-14	.250	PK	1
<b>60214*</b>	Non-Insulated Female Slip-On, pack of 28	16-14	.250	PK	1
<b>60251</b>	Non-Insulated Female Slip-On, pack of 26	12-10	.250	PK	1
<b>60251CX</b>	Non-Insulated Female Slip-On, pack of 100	12-10	.250	PK	1
<b>61224</b>	Non-Insulated Female Slip-On, pack of 14	12-10	.340	PK	1

\* This terminal features insulation grip.

**Fully Insulated Male Slip-Ons**

These male terminals crimp to the wires which relieves the need to solder. A variety of sizes are available and the slip ons are fully insulated in either vinyl or nylon.

**6234**

CATALOG NO.	DESCRIPTION	WIRE RANGE	TAB SIZE	UOM	ORDER MULTIPLE
<b>6234</b>	Fully Insulated Male Slip-On, pack of 14	16-14	.250	PK	1
<b>6234LX</b>	Fully Insulated Male Slip-On, pack of 50	16-14	.250	PK	1
<b>61235LX</b>	Fully Insulated Male Slip-On, pack of 50	12-10	.250	PK	1

**Non-Insulated Flag Female Slip-Ons**

These non insulated female terminals crimp to the wires which relieves the need to solder. A variety of sizes are available. Part 6213 features insulation grip.

**6224**

CATALOG NO.	DESCRIPTION	WIRE RANGE	TAB SIZE	UOM	ORDER MULTIPLE
<b>60213</b>	Non-Insulated Flag Female Slip-On, pack of 26	16-14	.187	PK	1
<b>60213CX</b>	Non-Insulated Flag Female Slip-On, pack of 100	16-14	.187	PK	1
<b>6213</b>	Non-Insulated Flag Female Slip-On, pack of 34	16-14	.250	PK	1
<b>6213CX</b>	Non-Insulated Flag Female Slip-On, pack of 100	16-14	.250	PK	1
<b>6224</b>	Non-Insulated Flag Female Slip-On, pack of 20	12-10	.250	PK	1
<b>6224CX</b>	Non-Insulated Flag Female Slip-On, pack of 100	12-10	.250	PK	1



## SLIP-ON SOLDERLESS TERMINALS cont'd

### Fully Insulated Flag Female Slip-Ons

These female terminals crimp to the wires which relieves the need to solder. A variety of sizes are available and the slip-ons are fully insulated in either vinyl or nylon.

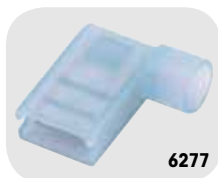

CATALOG NO.	DESCRIPTION	WIRE RANGE	TAB SIZE	UOM	ORDER MULTIPLE
6277	Fully Insulated Flag Female Slip-On, pack of 9	16-14	.250	PK	1
6277NX	Fully Insulated Flag Female Slip-On, pack of 25	16-14	.250	PK	1

### Combination Pack: Set of 6233 and 6234

Our Combination pack holds both a Fully Insulated Male and Female Slip On.



CATALOG NO.	DESCRIPTION	WIRE RANGE	TAB SIZE	UOM	ORDER MULTIPLE
61233	Set of Fully Insulated M/F Slip-Ons, pack of 6 pairs	16-14	.250	PK	1
61233LX	Set of Fully Insulated M/F Slip-Ons, pack of 25 pairs	16-14	.250	PK	1

### Flag Female Compressor Terminal Kit

Parts 6258, 6271, 6259, 6273, 6270 in a four compartment, clear plastic box. Parts 6270 and 6273 are put in the same compartment.



CATALOG NO.	DESCRIPTION	UOM	ORDER MULTIPLE
6200HX	Flag Female Compressor Terminal Kit	EA	1

### Flag Female Compressor Terminals

Also known as hermetic header terminals, these non-insulated terminals are designed with a larger distance between the "rolls" to allow for the rod in hermetic header applications. The increased distance allows the rod to slip in between them. Parts 6258 and 6259 are notched for bending. The notches are cut between the slip-on portion and the conductor barrel and enable the back of the slip-on portion to be folded against the conductor barrel after the wire connection is made. This terminal features insulation grip.



CATALOG NO.	DESCRIPTION	WIRE RANGE	FITS	UOM	ORDER MULTIPLE
6271	Flag Female Compressor Terminal, pack of 12	18-16	.090 pin	PK	1
6271CX	Flag Female Compressor Terminal, pack of 100	18-16	.090 pin	PK	1
6273LX	Flag Female Compressor Terminal, pack of 50	18-12	.250 tab	PK	1
6270	Flag Female Compressor Terminal, pack of 9	12-8	.250 tab	PK	1
6270LX	Flag Female Compressor Terminal, pack of 50	12-8	.250 tab	PK	1
6258*	Flag Female Compressor Terminal, pack of 17	16-14	.250 tab	PK	1
6258CX*	Flag Female Compressor Terminal, pack of 100	16-14	.250 tab	PK	1
6259	Flag Female Compressor Terminal, pack of 14	12-10	.250 tab	PK	1
6259CX	Flag Female Compressor Terminal, pack of 100	12-10	.250 tab	PK	1

\*This terminal features insulation grip.

### Compressor Lead Kit

Our Compressor Lead kit includes the following products: a flag female compressor terminal (.250 tab; part 62589), a waterproof butt connector (12 10 wire range; part 62231), and a piece of 10 gauge wire.



CATALOG NO.	DESCRIPTION	UOM	ORDER MULTIPLE
60259HX	Compressor Lead Kit with 12" wire	EA	1

## SPECIAL PURPOSE SOLDERLESS TERMINALS

### Insulated Plugs

These insulated terminals crimp to the wires which relieves the need to solder.



CATALOG NO.	DESCRIPTION	WIRE RANGE	UOM	ORDER MULTIPLE
6283	Insulated Plugs, pack of 17	22-18	PK	1
6283LX	Insulated Plugs, pack of 50	22-18	PK	1
6285	Insulated Plugs, pack of 17	16-14	PK	1
6285LX	Insulated Plugs, pack of 50	16-14	PK	1

### Non-Insulated Plugs

These insulated terminals crimp to the wires which relieves the need to solder.

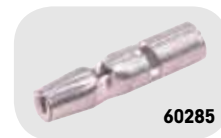

CATALOG NO.	DESCRIPTION	WIRE RANGE	UOM	ORDER MULTIPLE
60285	Non-Insulated Plugs, pack of 37	16-14	PK	1

### Fully Insulated Receptacles

These insulated terminals crimp to the wires which relieves the need to solder.

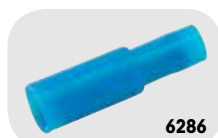

CATALOG NO.	DESCRIPTION	WIRE RANGE	UOM	ORDER MULTIPLE
6284	Fully Insulated Receptacles, pack of 12	22-18	PK	1
6284LX	Fully Insulated Receptacles, pack of 50	22-18	PK	1
6286	Fully Insulated Receptacles, pack of 12	16-14	PK	1
6286LX	Fully Insulated Receptacles, pack of 50	16-14	PK	1

### Combination Packs

These insulated terminals crimp to the wires which relieves the need to solder.



CATALOG NO.	DESCRIPTION	UOM	ORDER MULTIPLE
6288	Combination Pack with parts 6283 and 6284, pack of 7 pairs	PK	1
6288LX	Combination Pack with parts 6283 and 6284, pack of 25 pairs	PK	1
6289	Combination Pack with parts 6285 and 6286, pack of 7 pairs	PK	1
6289LX	Combination Pack with parts 6285 and 6286, pack of 25 pairs	PK	1

**SPECIAL PURPOSE SOLDERLESS TERMINALS cont'd****Tab Adapters – Quick Disconnect with Screw**

These insulated terminals crimp to the wires which relieves the need to solder.



CATALOG NO.	DESCRIPTION	UOM	ORDER MULTIPLE
6209	Fits .250 Tab, #6-32 x 1/4" Screw, pack of 5	PK	1
6209LX	Fits .250 Tab, #6-32 x 1/4" Screw, pack of 50	PK	1

**Tab Adapters – Single Female Double Male Tabs**

These insulated terminals crimp to the wires which relieves the need to solder. .250 male, .250 female.



CATALOG NO.	DESCRIPTION	TAB SIZE	UOM	ORDER MULTIPLE
6208	Tab Adapter; 1 female, 2 male; Bent 90°, pack of 12	.250	PK	1
6208LX	Tab Adapter; 1 female, 2 male; Bent 90°, pack of 50	.250	PK	1
6211	Tab Adapter; 1 female, 2 male; Wye, pack of 27	.250	PK	1
6211CX	Tab Adapter; 1 female, 2 male; Wye, pack of 100	.250	PK	1
6212	Tab Adapter; 1 female, 2 male; Stacked, pack of 16	.250	PK	1
6212CX	Tab Adapter; 1 female, 2 male; Stacked, pack of 100	.250	PK	1
60234	Tab Adapter; 1 female, 2 male; Fully Insulated, pack of 12	.250	PK	1

**Tap Connectors**

These insulated terminals crimp to the wires which relieves the need to solder. Designed to make tap splices.



CATALOG NO.	DESCRIPTION	WIRE RANGE	UOM	ORDER MULTIPLE
6241	Tap Splice – blue, pack of 15	16-14	PK	1
6245	Tap Splice, mates w/.250 tab – blue, pack of 9	18-14	PK	1

**Tab Adapters – Piggy Back Slip-Ons**

These insulated terminals crimp to the wires which relieves the need to solder. Multi-stack, .250 male tab, .250 female slip-on.

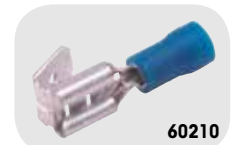

CATALOG NO.	DESCRIPTION	WIRE RANGE	UOM	ORDER MULTIPLE
6210	Non-Insulated Piggy Back Slip-Ons, pack of 20	16-14	PK	1
6210CX	Non-Insulated Piggy Back Slip-Ons, pack of 100	16-14	PK	1
60210	Insulated Piggy Back Slip-Ons, pack of 11	16-14	PK	1
60210LX	Insulated Piggy Back Slip-Ons, pack of 50	16-14	PK	1
60210CX	Insulated Piggy Back Slip-Ons, pack of 100	16-14	PK	1

**Tab Adapters – Male Tabs**

These insulated terminals crimp to the wires which relieves the need to solder.



CATALOG NO.	DESCRIPTION	TAB SIZE	STUD	UOM	ORDER MULTIPLE
61230	Male Tabs – Straight, pack of 23	.250	#6	PK	1
61230CX	Male Tabs – Straight, pack of 100	.250	#6	PK	1
6230	Male Tabs – Straight, pack of 28	.250	#8	PK	1
6230CX	Male Tabs – Straight, pack of 100	.250	#8	PK	1
60230CX	Male Tabs – Straight, pack of 100	.250	#10	PK	1
60249	Male Tabs – 1 pair, bent 90°, pack of 22	.250	#10	PK	1

**Fully Insulated Dead End Connectors**

These insulated terminals crimp to the wires which relieves the need to solder.



CATALOG NO.	DESCRIPTION	WIRE RANGE	UOM	ORDER MULTIPLE
6222	Fully Insulated Dead End Connectors, pack of 27	22-14	PK	1
6222LX	Fully Insulated Dead End Connectors, pack of 50	22-14	PK	1
6223	Fully Insulated Dead End Connectors, pack of 21	18-10	PK	1
6223LX	Fully Insulated Dead End Connectors, pack of 50	18-10	PK	1
6250	Fully Insulated Dead End Connectors, pack of 8	18-8	PK	1

**STANDARD SOLDERLESS TERMINALS****Insulated Hooks**

These insulated terminals crimp to the wires which relieves the need to solder.



CATALOG NO.	DESCRIPTION	WIRE RANGE	STUD	UOM	ORDER MULTIPLE
6242	Insulated Hooks, pack of 22	22-18	#8	PK	1
6242LX	Insulated Hooks, pack of 50	22-18	#8	PK	1
6244	Insulated Hooks, pack of 20	16-14	#8	PK	1
6244LX	Insulated Hooks, pack of 50	16-14	#8	PK	1

**Insulated Butt Connectors**

These insulated terminals crimp to the wires which relieves the need to solder.



CATALOG NO.	DESCRIPTION	WIRE RANGE	UOM	ORDER MULTIPLE
6232	Insulated Butt Connector, pack of 26	22-18	PK	1
6232LX	Insulated Butt Connector, pack of 50	22-18	PK	1
6232CX	Insulated Butt Connector, pack of 100	22-18	PK	1
6217	Insulated Butt Connector, pack of 27	16-14	PK	1
6217LX	Insulated Butt Connector, pack of 50	16-14	PK	1
6217CX	Insulated Butt Connector, pack of 100	16-14	PK	1
6231	Insulated Butt Connector, pack of 16	12-10	PK	1
6231LX	Insulated Butt Connector, pack of 50	12-10	PK	1
6231CX	Insulated Butt Connector, pack of 100	12-10	PK	1
6287	Insulated Butt Connector, pack of 5	22-18	PK	1
6287XX	Insulated Butt Connector, pack of 10	8	PK	1
6287NX	Insulated Butt Connector, pack of 25	8	PK	1

## STANDARD SOLDERLESS TERMINALS cont'd

### Butt Connector Assortment Kit

This Assortment is a perfect addition to the HVAC kit. It includes an Insulated Butt Connector, a Non Insulated Butt Connector, and a Nylon Insulated Butt Connector. Includes parts 6217, 6231, and 6232.

6200BSX



CATALOG NO.	DESCRIPTION	UOM	ORDER MULTIPLE
6200BSX	Butt Connector Assortment Kit	EA	1

### Insulated Spades

These insulated terminals crimp to the wires which relieves the need to solder.

61214



CATALOG NO.	DESCRIPTION	WIRE RANGE	STUD	UOM	ORDER MULTIPLE
61214	Insulated Spades, pack of 23	22-18	#6	PK	1
6237	Insulated Spades, pack of 22	22-18	#8	PK	1
6237LX	Insulated Spades, pack of 50	22-18	#8	PK	1
61256	Insulated Spades, pack of 23	22-18	#10	PK	1
61256LX	Insulated Spades, pack of 50	22-18	#10	PK	1
6274	Insulated Spades, pack of 22	16-14	#6	PK	1
6274LX	Insulated Spades, pack of 50	16-14	#6	PK	1
6227	Insulated Spades, pack of 22	16-14	#8	PK	1
6227LX	Insulated Spades, pack of 50	16-14	#8	PK	1
6227CX	Insulated Spades, pack of 100	16-14	#8	PK	1
6228	Insulated Spades, pack of 22	16-14	#10	PK	1
6228LX	Insulated Spades, pack of 50	16-14	#10	PK	1
60274	Insulated Spades, pack of 18	12-10	#6	PK	1
60254	Insulated Spades, pack of 18	12-10	#8	PK	1
60254LX	Insulated Spades, pack of 50	12-10	#8	PK	1
60254CX	Insulated Spades, pack of 100	12-10	#8	PK	1
6255	Insulated Spades, pack of 17	12-10	#10	PK	1
6255LX	Insulated Spades, pack of 50	12-10	#10	PK	1
6255CX	Insulated Spades, pack of 100	12-10	#10	PK	1

### Non-Insulated Spring Spades

These non insulated terminals crimp to the wires which relieves the need to solder.

60226



CATALOG NO.	DESCRIPTION	WIRE RANGE	STUD	UOM	ORDER MULTIPLE
60238	Non-Insulated Spring Spades, pack of 25	22-18	#8	PK	1
60201	Non-Insulated Spring Spades, pack of 27	22-18	#10	PK	1
60226	Non-Insulated Spring Spades, pack of 24	16-14	#8	PK	1
60240	Non-Insulated Spring Spades, pack of 27	16-14	#10	PK	1

### Non-Insulated Spades

These non insulated terminals crimp to the wires which relieves the need to solder.

61215



CATALOG NO.	DESCRIPTION	WIRE RANGE	STUD	UOM	ORDER MULTIPLE
61215	Non-Insulated Spades, pack of 22	22-18	#6	PK	1
61275CX	Non-Insulated Spades, pack of 100	16-14	#6	PK	1
6226	Non-Insulated Spades, pack of 23	16-14	#10	PK	1
6226CX	Non-Insulated Spades, pack of 100	16-14	#10	PK	1
61274	Non-Insulated Spades, pack of 16	12-10	#6	PK	1
61218	Non-Insulated Spades, pack of 17	12-10	#8	PK	1
6254	Non-Insulated Spades, pack of 22	12-10	#10	PK	1
6254LX	Non-Insulated Spades, pack of 50	12-10	#10	PK	1
6254CX	Non-Insulated Spades, pack of 100	12-10	#10	PK	1

### Insulated Spring Spades

These insulated terminals crimp to the wires which relieves the need to solder.

6238



CATALOG NO.	DESCRIPTION	WIRE RANGE	STUD	UOM	ORDER MULTIPLE
60209	Insulated Spring Spades, pack of 22	22-18	#6	PK	1
6238	Insulated Spring Spades, pack of 22	22-18	#8	PK	1
6238LX	Insulated Spring Spades, pack of 50	22-18	#8	PK	1
6276	Insulated Spring Spades, pack of 21	16-14	#6	PK	1
6276LX	Insulated Spring Spades, pack of 50	16-14	#6	PK	1
6239	Insulated Spring Spades, pack of 22	16-14	#8	PK	1
6239LX	Insulated Spring Spades, pack of 50	16-14	#8	PK	1
60228	Insulated Spring Spades, pack of 22	16-14	#10	PK	1
60256	Insulated Spring Spades, pack of 17	12-10	#8	PK	1
60256CX	Insulated Spring Spades, pack of 100	12-10	#8	PK	1
60255	Insulated Spring Spades, pack of 16	12-10	#10	PK	1
60255LX	Insulated Spring Spades, pack of 50	12-10	#10	PK	1

### Insulated Flange Spades

These insulated terminals crimp to the wires which relieves the need to solder.

61237



CATALOG NO.	DESCRIPTION	WIRE RANGE	STUD	UOM	ORDER MULTIPLE
61236	Insulated Flange Spades, pack of 21	22-18	#6	PK	1
61237	Insulated Flange Spades, pack of 21	22-18	#8	PK	1
61239	Insulated Flange Spades, pack of 17	16-14	#6	PK	1
61276	Insulated Flange Spades, pack of 22	16-14	#8	PK	1
61276LX	Insulated Flange Spades, pack of 50	16-14	#8	PK	1
61255	Insulated Flange Spades, pack of 16	12-10	#10	PK	1
61255LX	Insulated Flange Spades, pack of 50	12-10	#10	PK	1

**STANDARD SOLDERLESS TERMINALS cont'd****Insulated Rings**

These insulated terminals crimp to the wires which relieves the need to solder.

**61202**

CATALOG NO.	DESCRIPTION	WIRE RANGE	STUD	UOM	ORDER MULTIPLE
61202	Insulated Rings, pack of 22	22-18	#6	PK	1
6236LX	Insulated Rings, pack of 50	22-18	#8	PK	1
61206	Insulated Rings, pack of 19	22-18	1/4"	PK	1
61208	Insulated Rings, pack of 17	22-18	5/16"	PK	1
6272	Insulated Rings, pack of 22	16-14	#6	PK	1
60272LX	Insulated Rings, pack of 50	16-14	#8	PK	1
6216	Insulated Rings, pack of 23	16-14	#10	PK	1
6216LX	Insulated Rings, pack of 50	16-14	#10	PK	1
6216CX	Insulated Rings, pack of 100	16-14	#10	PK	1
60216	Insulated Rings, pack of 20	16-14	1/4"	PK	1
61204	Insulated Rings, pack of 19	16-14	5/16"	PK	1
60245	Insulated Rings, pack of 17	16-14	3/8"	PK	1
60247	Insulated Rings, pack of 17	12-10	#6	PK	1
60252CX	Insulated Rings, pack of 100	12-10	#8	PK	1
6252	Insulated Rings, pack of 17	12-10	#10	PK	1
6252LX	Insulated Rings, pack of 50	12-10	#10	PK	1
6253LX	Insulated Rings, pack of 50	12-10	1/4"	PK	1
6253CX	Insulated Rings, pack of 100	12-10	1/4"	PK	1
61212	Insulated Rings, pack of 13	12-10	5/16"	PK	1
60253	Insulated Rings, pack of 13	12-10	3/8"	PK	1
60253LX	Insulated Rings, pack of 50	12-10	3/8"	PK	1
61254	Insulated Rings, pack of 10	12-10	1/2"	PK	1
6257	Insulated Rings, pack of 6	8	1/4"	PK	1
6257NX	Insulated Rings, pack of 25	8	1/4"	PK	1
60258NX	Insulated Rings, pack of 25	8	3/8"	PK	1
61252	Insulated Rings, pack of 5	6	5/16"	PK	1
61252NX	Insulated Rings, pack of 25	6	5/16"	PK	1

**Non-Insulated Rings**

These non insulated terminals crimp to the wires which relieves the need to solder.

**60206**

CATALOG NO.	DESCRIPTION	WIRE RANGE	STUD	UOM	ORDER MULTIPLE
60206	Non-Insulated Rings, pack of 25	22-18	#10	PK	1
61207	Non-Insulated Rings, pack of 24	22-18	1/4"	PK	1
61209	Non-Insulated Rings, pack of 19	22-18	5/16"	PK	1
61211	Non-Insulated Rings, pack of 20	22-18	3/8"	PK	1
6215	Non-Insulated Rings, pack of 27	16-14	#8	PK	1
6215CX	Non-Insulated Rings, pack of 100	16-14	#8	PK	1
60215	Non-Insulated Rings, pack of 24	16-14	#10	PK	1
60215CX	Non-Insulated Rings, pack of 100	16-14	#10	PK	1
60205	Non-Insulated Rings, pack of 21	16-14	1/4"	PK	1
60205CX	Non-Insulated Rings, pack of 100	16-14	1/4"	PK	1
61205	Non-Insulated Rings, pack of 23	16-14	5/16"	PK	1
61205CX	Non-Insulated Rings, pack of 100	16-14	5/16"	PK	1
61245	Non-Insulated Rings, pack of 17	16-14	3/8"	PK	1
60204	Non-Insulated Rings, pack of 20	12-10	#8	PK	1
60202	Non-Insulated Rings, pack of 17	12-10	1/4"	PK	1
61213	Non-Insulated Rings, pack of 12	12-10	5/16"	PK	1

**Flag Rings**

These flag ring terminals allow an easy fit to the wires which relieves the need to solder.

**6247**

CATALOG NO.	DESCRIPTION	WIRE RANGE	STUD	UOM	ORDER MULTIPLE
6247	Flag Rings, pack of 27	16-14	#10	PK	1
6247CX	Flag Rings, pack of 100	16-14	#10	PK	1
6248	Flag Rings, pack of 20	12-10	#10	PK	1

**WATERPROOF SOLDERLESS TERMINALS****Waterproof Rings**

Waterproof Rings are assembled with high grade heat shrinkable insulation. When heated, the insulation shrinks around the crimped connection and wire, effectively sealing out moisture and carrion. It also offers a wire insulation grip for severe vibration applications.

**62236**

CATALOG NO.	DESCRIPTION	WIRE RANGE	STUD	UOM	ORDER MULTIPLE
62236	Waterproof Rings, pack of 5	22-18	#8	PK	1
62273	Waterproof Rings, pack of 4	16-14	#8	PK	1

**Waterproof Spades**

Waterproof Spades Slip Ons are assembled with high grade heat shrinkable insulation. When heated, the insulation shrinks around the crimped connection and wire, effectively sealing out moisture and carrion. Use a wire insulation grip for severe vibration applications.

**62227**

CATALOG NO.	DESCRIPTION	WIRE RANGE	STUD	UOM	ORDER MULTIPLE
62227	Waterproof Spades, pack of 5	16-14	#8	PK	1
62228	Waterproof Spades, pack of 4	16-14	#10	PK	1

**Waterproof Butt Connectors**

Waterproof Butt Connectors are assembled with high grade heat shrinkable insulation. When heated, the insulation shrinks around the crimped connection and wire, effectively sealing out moisture and carrion. Use a wire insulation grip for severe vibration applications.

**62232**

CATALOG NO.	DESCRIPTION	WIRE RANGE	UOM	ORDER MULTIPLE
62232	Waterproof Butt Connectors, pack of 4	22-18	PK	1
62232XX	Waterproof Butt Connectors, pack of 10	22-18	PK	1
62231	Waterproof Butt Connectors, pack of 3	12-10	PK	1
62231XX	Waterproof Butt Connectors, pack of 10	12-10	PK	1

## HIGH TEMPERATURE SOLDERLESS TERMINALS

### High Temperature Male Slip-Ons

The High Temperature Male Slip Ons are constructed of nickel plated steel. These non insulated terminals are rated at 900 degree F (482 degree C).



CATALOG NO.	DESCRIPTION	WIRE RANGE	TAB SIZE	UOM	ORDER MULTIPLE
4220	High Temp. Male Slip-Ons, pack of 21	16-14	.250	PK	1
4220CX	High Temp. Male Slip-Ons, pack of 100	16-14	.250	PK	1
4219	High Temp. Male Slip-Ons, pack of 21	12-10	.250	PK	1

### High Temperature Flag Female Slip-Ons

The High Temperature Flag Female Slip Ons are constructed of nickel plated steel. These non insulated terminals are rated at 900 degree F (482 degree C).



CATALOG NO.	DESCRIPTION	WIRE RANGE	TAB SIZE	UOM	ORDER MULTIPLE
4213	High Temp. Flag Female Slip-Ons, pack of 16	16-14	.250	PK	1
4213CX	High Temp. Flag Female Slip-Ons, pack of 100	16-14	.250	PK	1
4224	High Temp. Flag Female Slip-Ons, pack of 11	12-10	.250	PK	1
4224NX	High Temp. Flag Female Slip-Ons, pack of 25	12-10	.250	PK	1
4224CX	High Temp. Flag Female Slip-Ons, pack of 100	12-10	.250	PK	1

### High Temperature Rings

The High Temperature Rings are constructed of nickel plated steel. These non insulated terminals are rated at 900 degree F (482 degree C).



CATALOG NO.	DESCRIPTION	WIRE RANGE	STUD	UOM	ORDER MULTIPLE
4206	High Temp. Rings, pack of 23	22-18	#6	PK	1
4206CX	High Temp. Rings, pack of 100	22-18	#6	PK	1
4236CX	High Temp. Rings, pack of 100	22-18	#10	PK	1
4272CX	High Temp. Rings, pack of 100	16-14	#6	PK	1
4215	High Temp. Rings, pack of 21	16-14	#10	PK	1
4215CX	High Temp. Rings, pack of 100	16-14	#10	PK	1
4205CX	High Temp. Rings, pack of 100	16-14	1/4"	PK	1
4252	High Temp. Rings, pack of 14	12-10	#10	PK	1
4252CX	High Temp. Rings, pack of 100	12-10	#10	PK	1
4253	High Temp. Rings, pack of 14	12-10	1/4"	PK	1
4253CX	High Temp. Rings, pack of 100	12-10	1/4"	PK	1

### High Temperature Female Slip-Ons

The High Temperature Female Slip Ons are constructed of nickel plated steel. These non insulated terminals are rated at 900 degree F (482 degree C).



CATALOG NO.	DESCRIPTION	WIRE RANGE	TAB SIZE	UOM	ORDER MULTIPLE
4221	High Temp. Female Slip-Ons, pack of 20	16-14	.187	PK	1
4221CX	High Temp. Female Slip-Ons, pack of 100	16-14	.187	PK	1
4214	High Temp. Female Slip-Ons, pack of 21	16-14	.250	PK	1
4214CX	High Temp. Female Slip-Ons, pack of 100	16-14	.250	PK	1
4204	High Temp. Female Slip-Ons, pack of 17	12-10	.250	PK	1
4204CX	High Temp. Female Slip-Ons, pack of 100	12-10	.250	PK	1

### High Temperature Spades

The High Temperature Spades Slip Ons are constructed of nickel plated steel. These non insulated terminals are rated at 900 degree F (482 degree C).



CATALOG NO.	DESCRIPTION	WIRE RANGE	STUD	UOM	ORDER MULTIPLE
4226	High Temp. Spades, pack of 23	16-14	#10	PK	1
4226CX	High Temp. Spades, pack of 100	16-14	#10	PK	1
4254CX	High Temp. Spades, pack of 100	12-10	#10	PK	1

### High Temperature Butt Connectors

The High Temperature Butt Connectors are constructed of nickel plated steel. These non insulated terminals are rated at 900 degree F (482 degree C).



CATALOG NO.	DESCRIPTION	WIRE RANGE	UOM	ORDER MULTIPLE
4217CX	High Temp. Butt Connectors, pack of 100	16-14	PK	1
4231	High Temp. Butt Connectors, pack of 17	12-10	PK	1

### High Temperature Assortment

The High Temperature Assortment Pack holds terminals that are constructed of nickel plated steel. These non insulated terminals are rated at 900 degree F (482 degree C). Includes parts 4213, 4215, and 4204, and 4254.



CATALOG NO.	DESCRIPTION	UOM	ORDER MULTIPLE
4200AX	High Temp. Assortment	EA	1



**DEVCO TERMINAL KITS**

CATALOG NO.	DESCRIPTION	TERMINALS																		
	<p><b>NOTE:</b> Some kits have parts not shown in chart. Please refer to the DESCRIPTION for these parts. Except where noted, kits come in clear plastic boxes.</p>			<b>HIGH TEMP</b>																
<b>6200HX</b>	<b>Flag Female Compressor Terminal Kit:</b> 8-18 wire range in a 4-compartment box with parts 6270 and 6273 in the same compartment.													6258	6259	6270	6271	6273		
<b>6200MX</b> <b>6200MSX*</b>	.187, .250 tabs; 12-10 wire range; #8, #10 studs in a 13-compartment polypropylene box.	6217 6231 6232	6218 6235 6251 6281		6216 6252				6213						6259					6211
<b>6201MX</b>	.187, .250 tabs; 22-10 wire range; #8, #10 studs in a 21-compartment metal box. (Includes parts 6233, 6234, and 6277, not shown in chart).	6217 6231 6232	6218 6235 6251 6281 6282		6216 6236 6252	6228	6238 6239			6224			6258	6259						6211
<b>6202MX</b>	<b>Insulated Terminal Kit:</b> .187, .250 tabs; 22-10 wire range; #8, #10, #6, 1/4" studs in an 18-compartment box. Parts 6233 & 6234, and parts 6222 & 6223 are pairs (not shown in chart).	6217 6231 6232	6218 6235 6251 6281 6282		6216 6252 6253 6272 60246	60254	6238 6239													
<b>6203MX</b>	<b>Non-Insulated Terminal Kit:</b> Includes High Temp. Terminals and Flag Female Compressor Terminals. .250 tab; 22-10 wire range; #8, #10 studs in an 18-compartment box. (Includes parts 6209 and 6210, not shown in chart).			4204 4213 4214 4215 4252 4254				6214	6213	6224			6258	6259	6270 6271	6230	6208	6211		
<b>4200AX</b>	<b>High Temperature Terminal Kit:</b> .250 tab; 16-10 wire; #10 stud in a bag.			4204 4213 4215 4254																
<b>6200X</b>	.250 tab; 16-14 wire; #8 stud in a 6-compartment box.	6217						6214	6213		6215						6230		6211	
<b>6200AX</b>	.250 tab; 16-14 wire range; #8, #10 studs in a 6-compartment box.	6217	6218		6216				6213								6230		6211	
<b>6200BX</b>	.250 tab; 16-14 wire; #8 stud in a 4-compartment box.							6214	6213		6215								6211	
<b>6200BSX</b>	22-10 wire range in a bag.	6217 6231 6232																		
<b>6200CX</b>	.250 tab; 16-14 wire; #10 stud in a 4-compartment box.		6218		6216				6213										6211	
<b>6200DX</b>	.250 tab; 12-10 wire range; #8, #10 studs in a 6-compartment box.	6231	6251		6252					6224							6230		6211	

\*Contains a crimper.



# ANCHORS

## Metal Drive Anchors

The anchors offer a Quick and Easy Solution for Light Duty Anchoring Jobs in Concrete and Masonry and Easy through type fastening, even when used in bottomless holes



CATALOG NO.	DESCRIPTION	SIZE	EMBEDMENT	PULLOUT LOAD	UOM	ORDER MULTIPLE
7233RLX	Drive Anchor, pack of 50	1/4" X 3/4"	5/8"	500 lb.	PK	1
7234RLX	Drive Anchor, pack of 50	1/4" X 1"	7/8"	944 lb.	PK	1
7235RLX	Drive Anchor, pack of 50	1/4" X 1-1/4"	1-1/8"	1,146 lb.	PK	1
7236R	Drive Anchor, pack of 10	1/4" X 1-1/2"	1-3/8"	854 lb.	PK	1
7236RLX	Drive Anchor, pack of 50	1/4" X 1-1/2"	1-3/8"	854 lb.	PK	1

## Drop-In Expansion Anchor Setting Tool

This tool is great for use while setting an anchor.



CATALOG NO.	DESCRIPTION	UOM	ORDER MULTIPLE
7146	For use with anchor part number 7142	EA	1
7147	For use with anchor part number 7143	EA	1

## Self-Drilling Gypsum Wallboard Anchors

These anchors pre drill precise holes in gypsum wallboard with no special tools required. The anchors are easily installed with a #2 or #3 Phillips screwdriver, slotted driver, or power driver. Plastic plugs toggles and toggles are easily replaced with the deep threaded products. There is a full range to cover all wall fastening applications and are available in corrosion resistant and non conductive white nylon. The product has a low profile head and can easily be backed out. They provide and strong engagement in 3/4in., 1/2in., and 5/8in. gypsum wallboard and are supplied with combo head screws.



CATALOG NO.	DESCRIPTION	SCREW SIZE	MAX. FIXTURE	UOM	ORDER MULTIPLE
7316X	E-Z Ancor®; nylon, pack of 10	#8 x 1-1/4"	3/4"	PK	1
7316L	E-Z Ancor®; nylon, pack of 50	#8 x 1-1/4"	3/4"	PK	1
7311X	E-Z Ancor®; zinc die cast*, pack of 10#6 x 1-1/4"	#6 x 1-1/4"	3/4"	PK	1
7311L	E-Z Ancor®; zinc die cast*, pack of 50#6 x 1-1/4"	#6 x 1-1/4"	3/4"	PK	1
7317X	E-Z Ancor Lite™; nylon, pack of 10 #6 x 1-1/4"	#6 x 1-1/4"	3/4"	PK	1
7317L	E-Z Ancor Lite™; nylon, pack of 50 #6 x 1-1/4"	#6 x 1-1/4"	3/4"	PK	1
7321X	E-Z Toggle™; zinc die cast; heavy-duty,#8 x 2-1/8" pack of 10	#8 x 2-1/8"	5/8"	PK	1

\*Smaller version of the E-Z Ancor® with a versatile core that can use #6 or #8 sheet metal screws or #6, #7, #8 drywall screws.

## Drive Fasteners

These steel fasteners can be driven into dry wall like a nail and are secured by turning the screw down completely to expand the ribs.



CATALOG NO.	DESCRIPTION	HOLE SIZE	GRIP RANGE	UOM	ORDER MULTIPLE
7301	Drive Fastener, pack of 6	1/4"	3/16" to 3/8"	PK	1
7302	Drive Fastener, pack of 6	1/4"	1/8" to 1/2"	PK	1
7303	Drive Fastener, pack of 6	1/4"	1/8" to 3/16"	PK	1

## Drop-In Expansion Anchors































These heavy duty anchors are made of carbon steel. They are set by means of an internal plug and setting tool.



CATALOG NO.	DESCRIPTION	BOLT SIZE	THREADS PER INCH	HOLE DEPTH	THREAD DEPTH	DRILL BIT SIZE	UOM	ORDER MULTIPLE
7142	Anchor, pack of 4	3/8"	18	1-5/8"	1/2"	1/2"	PK	1
7142LX	Anchor, pack of 50	3/8"	18	1-5/8"	1/2"	1/2"	PK	1
7143	Anchor, pack of 4	1/2"	13	2"	3/4"	5/8"	PK	1
7143LX	Anchor, pack of 50	1/2"	13	2"	3/4"	5/8"	PK	1



## DEVCO PLASTIC ANCHOR KITS

CATALOG NO.		ANCHOR	DRILL SIZE	DRILL BIT INCLUDED	SCREW	SCREW SIZE
SMALL PACK*	100 PACK					
	7103CX		$\frac{5}{32}$ 			#4 x 3/4"
	7101CX		$\frac{3}{16}$ 			#8 x 1"
	7101HCX					#8 x 1"
	7102CX		$\frac{1}{4}$ 			#10 x 1-1/4"
	7102HCX					#8 x 1"
	7106CX		$\frac{1}{4}$ 			#10 x 1
7106			$\frac{1}{4}$ 	None		#10 x 1"
7105LX			$\frac{5}{16}$ 			#14 x 1-1/2"
7111X	7111CX		$\frac{5}{16}$ 			#14 x 1"
	7111HCX					#14 x 1"

*SMALL PACK	COUNT
7104	37
7106	28
7111X	40
7105LX	50



## BOXES, RINGS, AND COVERS

### Steel Utility Boxes\*

Steel Utility Boxes are used for convenience outlets, switch boxes and small junction boxes. Galvanized steel.



PI360

CATALOG NO.	LENGTH	WIDTH	DEPTH	CAPACITY (cubic in.)	KNOCKOUT (in.)	UOM	ORDER MULTIPLE
PI360	4"	2-1/8"	1-7/8"	13.0	1/2	EA	1
PI360-3/4	4"	2-1/8"	1-7/8"	13.0	3/4 & 1/2	EA	1
PI361	4"	2-1/8"	2-1/8"	14.5	1/2	EA	1
PI361-3/4	4"	2-1/8"	2-1/8"	14.5	3/4 & 1/2	EA	1

### Steel Octagon Box\*

Steel Utility Boxes are used for convenience outlets, switch boxes and small junction boxes. Galvanized steel.



PI364

CATALOG NO.	LENGTH	WIDTH	DEPTH	CAPACITY (cubic in.)	KNOCKOUT (in.)	UOM	ORDER MULTIPLE
PI364	4"	4"	1-1/2"	15.5	3/4 & 1/2	EA	1

### Device Rings\*

Device rings are designed for projects of preexisting locations. They can help narrow an opening for a box in the sheet rock. They are also known as Plaster Rings. Galvanized steel.



PI387

CATALOG NO.	DESCRIPTION	NUMBER DEVICES	RAISED	UOM	ORDER MULTIPLE
PI387	1900 Device Ring	1	1/2"	EA	1
PI388	1900 Device Ring	2	1/2"	EA	1

### Utility Covers\*

These covers are 4 1/4in. x 2 11/32in. and are designed for appliances or emergency oil burners.



PI373

CATALOG NO.	DESCRIPTION	UOM	ORDER MULTIPLE
PI383	Appliance Switch, .4687" dia. hole, baked cadilite finish	EA	1
PI373	Red finish, "Emergency Oil Burner" in white letters	EA	1
PI374	Red finish, "Emergency Gas Burner" in white letters	EA	1

### Steel 1900 Boxes\*

Steel Utility Boxes are used for convenience outlets, switch boxes and small junction boxes. Galvanized steel.



PI362

CATALOG NO.	LENGTH	WIDTH	DEPTH	CAPACITY (cubic in.)	KNOCKOUT (in.)	UOM	ORDER MULTIPLE
PI362	4"	4"	1-1/2"	21.0	3/4 & 1/2	EA	1
PI363	4"	4"	2-1/8"	30.3	3/4 & 1/2	EA	1

### Extension Rings\*

Extension rings are used when extra cubic inch capacity is needed for additional wiring. Galvanized steel.



PI390

CATALOG NO.	LENGTH	WIDTH	DEPTH	CAPACITY (cubic in.)	KNOCKOUT (in.)	UOM	ORDER MULTIPLE
PI390	4"	2-1/8"	1-7/8"	13.0	1/2	EA	1
PI391	4"	4"	1-1/2"	21.0	3/4 & 1/2	EA	1

### Plated Steel Utility Covers\*

Ideal for exposed work applications, providing an easy method for the installation of electrical devices (switches, receptacles, fans, lights, etc.)



PI365

CATALOG NO.	DESCRIPTION	WIDTH	LENGTH	UOM	ORDER MULTIPLE
PI365	Toggle Switch	2-11/32"	4-1/4"	EA	1
PI366	Duplex Receptacle	2-11/32"	4-1/4"	EA	1
PI367	Blank Cover	2-11/32"	4-1/4"	EA	1
PI375	Standard Single Receptacle	2-11/32"	4-1/4"	EA	1

### Utility Plates\*

These plates are 4 1/4in. x 2 11/32in. and are designed for emergency oil burners.



PI393

CATALOG NO.	DESCRIPTION	UOM	ORDER MULTIPLE
PI393	Red finish, "Emergency Oil Burner" in white letters	EA	1
PI394	Red finish, "Emergency Gas Burner" in white letters	EA	1

\*Items in this section are Underwriter's Laboratories listed or recognized under the prime manufacturer's name.

**BOXES, RINGS, AND COVERS cont'd****Steel 1900 Covers\***

The covers are baked in a cadillite finished steel and are raised 1/2 in. with fully depressed corners. Size: 4" x 4".



CATALOG NO.	DESCRIPTION	UOM	ORDER MULTIPLE
PI377	Single Toggle	EA	1
PI378	Single Duplex Receptacle	EA	1
PI379	One Standard Single Receptacle	EA	1
PI368	Toggle Switch and Duplex Receptacle	EA	1
PI369	Two Duplex Receptacles	EA	1
PI370	Toggle Switch and Standard Single Receptacle	EA	1
PI371	Flat, Blank, Galvanized steel (not Cadillite finished)	EA	1

**Weatherproof Covers\***

These covers can be used with item PI385 and come with gaskets.

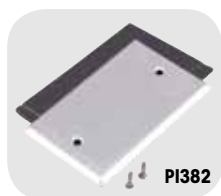

CATALOG NO.	DESCRIPTION	UOM	ORDER MULTIPLE
PI382	Blank Cover	EA	1
PI386	Lever Switch Cover for standard toggle type switches	EA	1
PI389	Duplex Receptacle Cover	EA	1
PI389-GFI	GFI Receptacle Cover	EA	1

**Weatherproof Boxes\***

Heavy duty die cast aluminum with baked aluminum finish. Boxes have two closure plugs and three holes. Item is Underwriter's Laboratories listed or recognized under the prime manufacturer's name.



CATALOG NO.	LENGTH	WIDTH	DEPTH	CAPACITY (cubic in.)	HOLE SIZE (in.)	UOM	ORDER MULTIPLE
PI385	4-1/2"	2-3/4"	2"	19.0	1/2	EA	1
PI385-34	4-1/2"	2-3/4"	2"	19.0	3/4	EA	1

**Weatherproof Box with Lever Switch Cover\***

The box is heavy duty die cast aluminum with baked aluminum finish and has two closure plugs and three holes. The cover comes with the gaskets. Includes parts PI385 and PI386.



CATALOG NO.	DESCRIPTION	UOM	ORDER MULTIPLE
PI384	Weatherproof Box and Lever Switch Cover	EA	1

**Safety Plates\***

Safety plates, also called nail in plates, or nail plates, install quickly and protect wire, cable and pipes that may be installed in upright wood stud walls.



CATALOG NO.	DESCRIPTION	UOM	ORDER MULTIPLE
PI232	Safety Plate – approximately 6"	EA	6
PI232CX	Safety Plate – approximately 6"	EA	100

**BULBS****Incandescent Light Bulbs**

Multi-filaments support increased bulb light. Filaments have solid nickel leads. Brass base is rust and freeze resistant. Bulbs are designed for 130 volts. Rough Service bulbs are designed for maximum vibration resistance. Toughcoat helps prevent shattering on impact for superior safety. Comes in standard pack of six.



CATALOG NO.	DESCRIPTION	WATTS	UOM	ORDER MULTIPLE
5262	General Service Bulbs; rated: 5,000 hours, pack of 6	60	PK	1
5263	General Service Bulbs; rated: 5,000 hours, pack of 6	75	PK	1
5264	General Service Bulbs; rated: 5,000 hours, pack of 6	100	PK	1
5265	General Service Bulbs; rated: 5,000 hours, pack of 6	150	PK	1
5231	Rough Service Bulbs, pack of 6	75	PK	1
5232	Rough Service Bulbs, pack of 6	100	PK	1
5266	Rough Service Bulbs, pack of 6	150	PK	1
5250	Appliance Bulbs, pack of 6	25	PK	1

\*Items in this section are Underwriter's Laboratories listed or recognized under the prime manufacturer's name.

## CABLE CONNECTORS

### Zinc Plated Die Cast Steel Romex Connectors\*

These zinc plated die cast connectors are for use with Romex, Service, and UF Cables.



CATALOG NO.	DESCRIPTION	TRADE SIZE	KNOCKOUT	UOM	ORDER MULTIPLE
PI321	Zinc plated die cast Romex Connector, pack of 8	3/8"	1/2"	PK	1
PI320	Zinc plated die cast Romex Connector, pack of 25	3/8"	1/2"	PK	1
PI319	Zinc plated die cast Romex Connector, pack of 4	3/4"	3/4"	PK	1
PI319CX	Zinc plated die cast Romex Connector, pack of 100	3/4"	3/4"	PK	1

### BX and Greenfield Connectors\*

These connectors are used to terminate Flexible Metal Conduit to a knock out in a dry location box or enclosure. Zinc die cast.



CATALOG NO.	DESCRIPTION	TRADE SIZE	KNOCKOUT	UOM	ORDER MULTIPLE
PI311	Set Screw Type Connector, 25 per pack	3/8"	1/2"	EA	25
PI312	Set Screw Type Connector, 8 per pack	3/8"	1/2"	EA	8
PI322	Straight Connector, squeeze type, for armored cable and flexible conduit, 8 per pack	3/8"	1/2"	EA	8
PI315	90° Connector, 3 per pack	3/8"	1/2"	EA	3
PI341	90° Connector, 4 per pack	1/2"	1/2"	EA	4
PI342	90° Connector, 4 per pack	3/4"	3/4"	EA	4
PI325	Set Screw Connector, 6 per pack	1/2"	1/2"	EA	6
PI340	Combination Cable Connector suitable for Romex or BX and Greenfield, 8 per pack	3/8"	1/2"	EA	8
PI318	Duplex Connector with single screw, clamp type, 2 per pack	3/8"	1/2"	EA	2

### Thinwall E.M.T. Connectors\*

These are used to join EMT conduit to boxes on enclosures. Zinc die cast.



CATALOG NO.	DESCRIPTION	TRADE SIZE	KNOCKOUT	UOM	ORDER MULTIPLE
PI411	Compression Type Connectors, 8 per pack	1/2"	1/2"	EA	8
PI412	Compression Type Connectors, 8 per pack	3/4"	3/4"	EA	8
PI415	Compression Type Couplings, 8 per pack	1/2"		EA	8
PI416	Compression Type Couplings, 8 per pack	3/4"		EA	8
PI426	Compression Type Straight Connectors for connecting E.M.T. to Liquid-Tight, 8 per pack	3/4"		EA	8
PI419	Set Screw Type Connectors, 8 per pack	1/2"	1/2"	EA	8
PI431	Set Screw Type 90° Connectors, 8 per pack	1/2"	1/2"	EA	8
PI435	Set Screw Type Offset Connectors, 8 per pack	1/2"	1/2"	EA	8

### Combination Couplings\*

Combination Couplings are designed for connecting EMT to flexible steel conduit.



CATALOG NO.	DESCRIPTION	UOM	ORDER MULTIPLE
PI440	1/2" E.M.T. to 3/8" Flex, pack of 4	PK	1

### Rigid Conduit Bodies\*

These bodies are Aluminum and can be use indoor or outdoor. Use to gain access to the interior of a raceway for wire pulling, splicing (with limitations as specified by the NEC), and maintenance. This item comes with cover and gasket.



CATALOG NO.	DESCRIPTION	TRADE SIZE	BODY TYPE	UOM	ORDER MULTIPLE
PI458	Includes steel cover, screws, gasket	1/2"	Back (LB)	EA	1
PI459	Includes steel cover, screws, gasket	3/4"	Back (LB)	EA	1

### Liquid-Tite Connectors\*

These connectors are made of zinc die cast and can be used with Flexible Metal Conduits and non metallic conduits. Zinc die cast.



CATALOG NO.	DESCRIPTION	TRADE SIZE	KNOCKOUT	UOM	ORDER MULTIPLE
PI350	Straight Liquid-Tite Connector, 2 per pack	1/2"	1/2"	EA	2
PI351	Straight Liquid-Tite Connector, 2 per pack	3/4"	3/4"	EA	2
PI352	90° Liquid-Tite Connector	1/2"	1/2"	EA	1
PI353	90° Liquid-Tite Connector	3/4"	3/4"	EA	1
PI355	45° Liquid-Tite Connector	3/4"	3/4"	EA	1

\*Items in this section are Underwriter's Laboratories listed or recognized under the prime manufacturer's name.



## CABLE TIES AND ACCESSORIES

## Heavy Duty Nylon Cable Ties

Black ties are weather and UV resistant. Items in this section are Underwriters' Laboratories listed or recognized under the prime manufacturer's name.

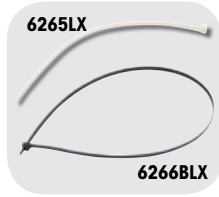

CATALOG NO.	DESCRIPTION	LENGTH	COLOR	MAX. BUNDLE DIAMETER	TENSILE STRENGTH	UOM	ORDER MULTIPLE
6265LX	Nylon; Heavy-duty, pack of 50	14"	Natural	4"	175 lb.	PK	1
6265CX	Nylon; Heavy-duty, pack of 100	14"	Natural	4"	175 lb.	PK	1
6265BLX	Nylon; Heavy-duty, pack of 50	14"	Black	4"	175 lb.	PK	1
6265BCX	Nylon; Heavy-duty, pack of 100	14"	Black	4"	175 lb.	PK	1
6266BLX	Nylon; Heavy-duty, pack of 50	36"	Black	11"	175 lb.	PK	1

## Nylon Cable Ties

Black ties are weather and UV resistant. Items in this section are Underwriters' Laboratories listed or recognized under the prime manufacturer's name.

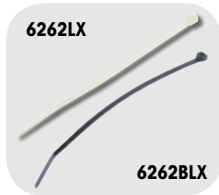

CATALOG NO.	DESCRIPTION	LENGTH	COLOR	MAX. BUNDLE DIAMETER	TENSILE STRENGTH	UOM	ORDER MULTIPLE
6267MX	Nylon Cable Ties, pack of 1,000	4"	Natural	13/16"	18 lb.	PK	1
6267BLX	Nylon Cable Ties, pack of 50	4"	Black	13/16"	18 lb.	PK	1
6267BCX	Nylon Cable Ties, pack of 100	4"	Black	13/16"	18 lb.	PK	1
6261BL	Nylon Cable Ties, pack of 50	6"	Black	1-3/8"	18 lb.	PK	1
6261CX	Nylon Cable Ties, pack of 100	6"	Natural	1-3/8"	18 lb.	PK	1
6261BCX	Nylon Cable Ties, pack of 100	6"	Black	1-3/8"	18 lb.	PK	1
6261MX	Nylon Cable Ties, pack of 1000	6"	Natural	1-3/8"	18 lb.	PK	1
6268BL	Nylon Cable Ties, pack of 50	6"	Black	1-3/8"	30 lb.	PK	1
6268CX	Nylon Cable Ties, pack of 100	6"	Natural	1-3/8"	30 lb.	PK	1
6268MX	Nylon Cable Ties, pack of 1000	6"	Natural	1-3/8"	30 lb.	PK	1
6268BMX	Nylon Cable Ties, pack of 1,000	6"	Black	1-3/8"	30 lb.	PK	1
6262LX	Nylon Cable Ties, pack of 50	7-1/2"	Natural	1-3/4"	50 lb.	PK	1
6262CX	Nylon Cable Ties, pack of 100	7-1/2"	Natural	1-3/4"	50 lb.	PK	1
6262MX	Nylon Cable Ties, pack of 1,000	7-1/2"	Natural	1-3/4"	50 lb.	PK	1
6262BLX	Nylon Cable Ties, pack of 50	7-1/2"	Black	1-3/4"	50 lb.	PK	1
6262BCX	Nylon Cable Ties, pack of 100	7-1/2"	Black	1-3/4"	50 lb.	PK	1
6262BMX	Nylon Cable Ties, pack of 1,000	7-1/2"	Black	1-3/4"	50 lb.	PK	1
6263NX	Nylon Cable Ties, pack of 25	11"	Natural	3"	50 lb.	PK	1
6263LX	Nylon Cable Ties, pack of 50	11"	Natural	3"	50 lb.	PK	1
6263CX	Nylon Cable Ties, pack of 100	11"	Natural	3"	50 lb.	PK	1
6263DX	Nylon Cable Ties, pack of 500	11"	Natural	3"	50 lb.	PK	1
6263BNX	Nylon Cable Ties, pack of 25	11"	Black	3"	50 lb.	PK	1
6263BLX	Nylon Cable Ties, pack of 50	11"	Black	3"	50 lb.	PK	1
6263BCX	Nylon Cable Ties, pack of 100	11"	Black	3"	50 lb.	PK	1
6263BDX	Nylon Cable Ties, pack of 500	11"	Black	3"	50 lb.	PK	1
60265NX	Nylon Cable Ties, pack of 25	14"	Natural	4"	50 lb.	PK	1
60265LX	Nylon Cable Ties, pack of 50	14"	Natural	4"	50 lb.	PK	1
60265BLX	Nylon Cable Ties, pack of 50	14"	Black	4"	50 lb.	PK	1

## Nylon Cable Ties with Mounting Hole

Black ties are weather and UV resistant. Items in this section are Underwriters' Laboratories listed or recognized under the prime manufacturer's name.



CATALOG NO.	DESCRIPTION	MOUNTING HOLE	LENGTH	COLOR	MAX. BUNDLE DIAMETER	TENSILE STRENGTH	UOM	ORDER MULTIPLE
60264CX	Tie w/mtg. hole, pack of 100	#8	6"	Natural	1-3/8"	30 lb.	PK	1
60264BLX	Tie w/mtg. hole, pack of 50	#8	6"	Black	1-3/8"	30 lb.	PK	1
60264BCX	Tie w/mtg. hole, pack of 100	#8	6"	Black	1-3/8"	30 lb.	PK	1
6264LX	Tie w/mtg. hole, pack of 50	#10	7"	Natural	1-3/4"	50 lb.	PK	1
6264CX	Tie w/mtg. hole, pack of 100	#10	7"	Natural	1-3/4"	50 lb.	PK	1
6264BLX	Tie w/mtg. hole, pack of 50	#10	7"	Black	1-3/4"	50 lb.	PK	1
6264BCX	Tie w/mtg. hole, pack of 100	#10	7"	Black	1-3/4"	50 lb.	PK	1
6264BMX	Tie w/mtg. hole, pack of 1,000	#10	7"	Black	1-3/4"	50 lb.	PK	1
60263CX	Tie w/mtg. hole, pack of 100	#10	11"	Natural	3"	50 lb.	PK	1
60263BLX	Tie w/mtg. hole, pack of 50	#10	11"	Black	3"	50 lb.	PK	1
60263BCX	Tie w/mtg. hole, pack of 100	#10	11"	Black	3"	50 lb.	PK	1
61265LX	Tie w/mtg. hole, pack of 50	#10	14"	Natural	4"	50 lb.	PK	1
61265BCX	Tie w/mtg. hole, pack of 100	#10	14"	Black	4"	50 lb.	PK	1

## Black Nylon Cable Tie Assortment

Black ties are weather and UV resistant. Items in this section are Underwriters' Laboratories listed or recognized under the prime manufacturer's name.

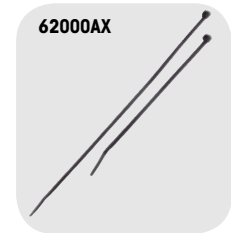

CATALOG NO.	DESCRIPTION	LENGTH	COLOR	MAX. BUNDLE DIAMETER	TENSILE STRENGTH	UOM	ORDER MULTIPLE
62000AX	Assortment	7-1/2"	Black	1-3/4"	50 lb.	EA	1
		11"	Black	3"	50 lb.		

## Cable Tie Mounts

Approximately 1in. square adhesive backed. These mounts can be mounted with a screw and will accept up to 75 lb. ties.



CATALOG NO.	DESCRIPTION	UOM	ORDER MULTIPLE
6269	Cable Tie Mounts; 1" square; adhesive backed, pack of 11	PK	1
6269LX	Cable Tie Mounts; 1" square; adhesive backed, pack of 50	PK	1
6269CX	Cable Tie Mounts; 1" square; adhesive backed, pack of 100	PK	1
6269MX	Cable Tie Mounts; 1" square; adhesive backed, pack of 1,000	PK	1

## CONDUIT FITTINGS

### Straps

Our zinc plated steel straps are designed to hold conduit pipe.



CATALOG NO.	DESCRIPTION	UOM	ORDER MULTIPLE
PI306	Straps fit 1/2" E.M.T. Conduit, pack of 20	PK	1
PI306CX	Straps fit 1/2" E.M.T. Conduit, pack of 100	PK	1
PI307	Straps fit 3/4" E.M.T. Conduit, pack of 12	PK	1
PI307CX	Straps fit 3/4" E.M.T. Conduit, pack of 100	PK	1
PI908	Straps fit 1" E.M.T. Conduit, pack of 10	PK	1
PI908CX	Straps fit 1" E.M.T. Conduit, pack of 100	PK	1
PI909LX	Straps fit 1-1/4" E.M.T. Conduit, pack of 50	PK	1
PI206	Straps for 14-2 Romex, pack of 20	PK	1

### Knockout Seals and Hole Plug



CATALOG NO.	DESCRIPTION	UOM	ORDER MULTIPLE
PI316	For 1/2" knockouts, zinc plated steel, pack of 10	PK	1
PI317	For 3/4" knockouts, zinc plated steel, pack of 50	PK	1
ED406	Nylon Hole Plug for 3/8" hole, pack of 28	PK	1

### Conduit Nipples\*

PI301 is zinc die cast steel. PI303 is galvanized steel. All come with plated steel locknuts and plastic insulating bushings.



CATALOG NO.	DESCRIPTION	SIZE	CONNECTION	UOM	ORDER MULTIPLE
PI301	Conduit Nipple, pack of 2	1/2"	Offset	PK	1
PI303	Conduit Nipple, pack of 2	1/2" x 2"	Straight	PK	1

### Electrical Staples

We have steel, insulated copper finish, and plastic electrical staples available.



CATALOG NO.	DESCRIPTION	SIZE	UOM	ORDER MULTIPLE
PI330	Plastic; for 2 conductor Romex and other NM cable conductor; 12/2-14/2 range; UV protected, pack of 50	3/8" x 1/2"	PK	1
PI332	Plastic; for 3 conductor Romex and other NM cable conductor; 12/3-14/3 range; UV protected, pack of 50	3/8" x 3/4"	PK	1
PI309	Steel; non-insulated for Romex and NM cable; 14/2-10/3 range, pack of 154	1" x 1/2"	PK	1
ED273	Insulated coppered finish; size #5, pack of 50	5/8" x 1/4"	PK	1
ED273CX	Insulated coppered finish; size #5, pack of 100	5/8" x 1/4"	PK	1

### Reducing Washers

Reducing washers are for reducing knockout holes. These washers have raised flanges for a tight fit and are made of galvanized steel. PI308 reduces hole to fit appliance switch.



CATALOG NO.	DESCRIPTION	UOM	ORDER MULTIPLE
PI304	Reducing Washer – reduces hole from 1" to 1/2", pack of 10	PK	1
PI305	Reducing Washer – reduces hole from 1" to 3/4", pack of 10	PK	1
PI305LX	Reducing Washer – reduces hole from 1" to 3/4", pack of 50	PK	1
PI308**	Reducing Washer – reduces hole from 1/2" to 15/32", pack of 10	PK	1
PI310	Reducing Washer – reduces hole from 3/4" to 1/2", pack of 28	PK	1
PI310LX	Reducing Washer – reduces hole from 3/4" to 1/2", pack of 50	PK	1
PI911	Reducing Washer – reduces hole from 2" to 1/2", pack of 5	PK	1
PI912	Reducing Washer – reduces hole from 2" to 3/4", pack of 5	PK	1
PI912LX	Reducing Washer – reduces hole from 2" to 3/4", pack of 50	PK	1
PI913	Reducing Washer – reduces hole from 1-1/2" to 1/2", pack of 4	PK	1
PI913LX	Reducing Washer – reduces hole from 1-1/2" to 1/2", pack of 50	PK	1
PI914	Reducing Washer – reduces hole from 1-1/2" to 3/4", pack of 4	PK	1

\*\*PI308 reduces hole to fit appliance switch.

### Conduit Nipples\*

Used to connect two electrical utility boxes where room is limited. Zinc die cast steel. Comes with plated steel locknuts.



CATALOG NO.	DESCRIPTION	SIZE	CONNECTION	UOM	ORDER MULTIPLE
PI203	Conduit Nipple, pack of 6	1/2"	Straight	PK	1

### Bushings and Locknuts

The locknuts and bushing are straight connectors provide excellent pullout strength and can be installed without disassembly. The compression nut ratchet prevents unintentional loosening.



CATALOG NO.	DESCRIPTION	UOM	ORDER MULTIPLE
PI331	Plastic "Anti-Short" Bushings for 14/2, 14/3, 12/2 BX cable, pack of 35	PK	1
PI344	3/4" Conduit Locknut, Zinc plated steel, pack of 10	PK	1
PI345*	1/2" Plastic Insulating Bushing, pack of 10	PK	1
PI346*	3/4" Plastic Insulating Bushing, pack of 10	PK	1

\*Items in this section are Underwriter's Laboratories listed or recognized under the prime manufacturer's name.



## GENERAL TOOLS

## Devco Crimpers

Crimps insulated and non insulated terminals 22 to 10 AWG, cuts bolts #4 40 through #10 24, and strips stranded wire 22 to 10 AWG and solid wire 18 to 8 AWG. Features two precision ground wire cutters, one on the nose and the other behind the pivot point. Plastic cushion handle.



5002

CATALOG NO.	DESCRIPTION	UOM	ORDER MULTIPLE
5002	Devco Crimpers; plastic coated handle	EA	1

## Magnetic Hex Chucks

Magnetic Hex Chucks may be used with an electric drill to drive hex washer head screws.



DE25

CATALOG NO.	DESCRIPTION	HEX HEAD SIZE	HEX HEAD DIAMETER	LENGTH	UOM	ORDER MULTIPLE
DE13	Magnetic Hex Chuck	1/4"	7/16"	1-3/4"	EA	1
DE14	Magnetic Hex Chuck	5/16"	1/2"	1-3/4"	EA	1
DE15	Magnetic Hex Chuck	3/8"	9/16"	1-7/8"	EA	1
DE23	Magnetic Hex Chuck	1/4"	7/16"	2-9/16"	EA	1
DE24	Magnetic Hex Chuck	5/16"	1/2"	2-9/16"	EA	1
DE25	Magnetic Hex Chuck	3/8"	9/16"	2-9/16"	EA	1
DE26	Magnetic Hex Chuck	7/16"	5/8"	2-9/16"	EA	1
DE33**	Magnetic Hex Chuck	1/4"	7/16"	3"	EA	1

\*\*Magnetic insert bit holder with a "C" ring retainer

## Blind Rivet Tools

Heavy duty hand rivet tool that offers long handles to increase leverage and to secure the rivet in the nosepiece while the tool is in use. Powerful riveting capacity with 4 standard nosepieces to set 3/32, 1/8, 5/32, and 3/16" blind rivets.



5107

CATALOG NO.	DESCRIPTION	UOM	ORDER MULTIPLE
5107	Heavy-duty tool; 4 interchangeable nose pieces to accommodate 3/32", 1/8", 5/32", 3/16" steel or aluminum rivets	EA	1

## NUTS AND BOLTS

## Finished Hex Nuts

The hex nuts are zinc plated steel.



6501

CATALOG NO.	DESCRIPTION	SIZE	UOM	ORDER MULTIPLE
6501	Finished Hex Nuts, pack of 60	1/4" - 20	PK	1
6501CX	Finished Hex Nuts, pack of 100	1/4" - 20	PK	1
6502	Finished Hex Nuts, pack of 38	5/16" - 18	PK	1
6503	Finished Hex Nuts, pack of 25	3/8" - 16	PK	1
6503CX	Finished Hex Nuts, pack of 100	3/8" - 16	PK	1
6505	Finished Hex Nuts, pack of 11	1/2" - 13	PK	1
6505LX	Finished Hex Nuts, pack of 50	1/2" - 13	PK	1
6507	Finished Hex Nuts, pack of 6	5/8" - 11	PK	1
6507LX	Finished Hex Nuts, pack of 50	5/8" - 11	PK	1

## Nylon Insert Lock Nuts

The lock nuts are zinc plated steel are in the NE series.



65001

CATALOG NO.	DESCRIPTION	SIZE	UOM	ORDER MULTIPLE
65001	Nylon Insert Lock Nuts, pack of 34	1/4" - 20	PK	1
65002	Nylon Insert Lock Nuts, pack of 26	5/16" - 18	PK	1

## Machine Screw Hex Nuts

The hex nuts are zinc plated steel.



6526

CATALOG NO.	DESCRIPTION	SIZE	UOM	ORDER MULTIPLE
6526	Machine Screw Hex Nuts, pack of 49	#8 - 32	PK	1
6528	Machine Screw Hex Nuts, pack of 44	#10 - 24	PK	1
6500A	Assortment, 23 of each	#6-32, #8-32, #10-32	EA	1

## Toggle Bolts

The toggle bolts are slotted round head machine screws with spring wings and are made of zinc plated steel.



7032

CATALOG NO.	DESCRIPTION	LENGTH	BOLT SIZE	HOLE SIZE	UOM	ORDER MULTIPLE
7032	Toggle Bolts, pack of 6	4"	1/8"	3/8"	PK	1
7033	Toggle Bolts, pack of 6	4"	3/16"	1/2"	PK	1
7034	Toggle Bolts, pack of 5	4"	1/4"	5/8"	PK	1
7036X	Toggle Bolts, pack of 4	4"	3/8"	1"	PK	1
7063	Toggle Bolts, pack of 5	6"	3/16"	1/2"	PK	1
7064	Toggle Bolts, pack of 4	6"	1/4"	5/8"	PK	1
7066X	Toggle Bolts, pack of 4	6"	3/8"	1"	PK	1
7066NX	Toggle Bolts, pack of 25	6"	3/8"	1"	PK	1

## NUTS AND BOLTS cont'd

### Stove Bolts

Stove Bolts are a combination of slotted round head machine screws and finished hex nuts. They are made of zinc plated steel.



CATALOG NO.	DESCRIPTION	SIZE	LENGTH	UOM	ORDER MULTIPLE
6401	Stove Bolts, pack of 42	#10 - 24	1/2"	PK	1
6402	Stove Bolts, pack of 38	#10 - 24	3/4"	PK	1
6403	Stove Bolts, pack of 34	#10 - 24	1"	PK	1
6404	Stove Bolts, pack of 27	#10 - 24	1-1/2"	PK	1
6405	Stove Bolts, pack of 22	#10 - 24	2"	PK	1
6411	Stove Bolts, pack of 22	1/4" - 20	1/2"	PK	1
6412	Stove Bolts, pack of 20	1/4" - 20	3/4"	PK	1
6413	Stove Bolts, pack of 18	1/4" - 20	1"	PK	1
6414	Stove Bolts, pack of 15	1/4" - 20	1-1/2"	PK	1
6415	Stove Bolts, pack of 13	1/4" - 20	2"	PK	1
6416	Stove Bolts, pack of 11	1/4" - 20	2-1/2"	PK	1

### Flat Washers

These washers are zinc plated steel with a USS Classification.

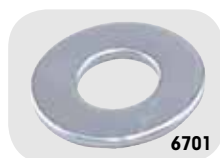

CATALOG NO.	DESCRIPTION	SIZE	INNER DIAMETER	OUTER DIAMETER	UOM	ORDER MULTIPLE
6701	Flat Washers (USS), pack of 160	3/16"	1/4"	9/16"	PK	1
6702	Flat Washers (USS), pack of 72	1/4"	5/16"	3/4"	PK	1
6703	Flat Washers (USS), pack of 33	5/16"	3/8"	7/8"	PK	1
6704	Flat Washers (USS), pack of 37	3/8"	7/16"	1"	PK	1
6704-2X	Flat Washers (USS), pack of 134	3/8"	7/16"	1"	PK	1
6706	Flat Washers (USS), pack of 11	1/2"	9/16"	1-3/8"	PK	1
6706-2X	Flat Washers (USS), pack of 52	1/2"	9/16"	1-3/8"	PK	1
6700AX	Assortment	All sizes included			EA	1

### Fender Washers

These washers are made of zinc plated steel.

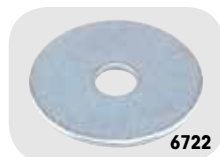

CATALOG NO.	DESCRIPTION	SIZE	INNER DIAMETER	OUTER DIAMETER	UOM	ORDER MULTIPLE
6722	Fender Washers, pack of 20	1/4"	9/32"	1-1/4"	PK	1
6722-2X	Fender Washers, pack of 92	1/4"	9/32"	1-1/4"	PK	1
6724	Fender Washers, pack of 12	3/8"	13/32"	1-1/2"	PK	1
6724-2X	Fender Washers, pack of 66	3/8"	13/32"	1-1/2"	PK	1

### Motor Bolts

Motor Bolts are all thread rods made of zinc metal steel. Each Bolt includes four machine screw hex nuts.



CATALOG NO.	DESCRIPTION	SIZE	LENGTH	UOM	ORDER MULTIPLE
6108	Motor Bolts, pack of 16	#8 - 32	1-1/2"	PK	1
6109	Motor Bolts, pack of 16	#10 - 32	1-1/2"	PK	1

### Hex Head Cap Screws

Hex Screw Cap Screws are made of low carbon, grade 2 steel and are USS Classified. The total thread length on these screws equal 2x diameter + 1/4in.



CATALOG NO.	DESCRIPTION	SIZE	LENGTH	UOM	ORDER MULTIPLE
6601	Hex Head Cap Screws, pack of 28	1/4" - 20	3/4"	PK	1
6602	Hex Head Cap Screws, pack of 25	1/4" - 20	1"	PK	1
6603	Hex Head Cap Screws, pack of 18	1/4" - 20	1-1/2"	PK	1
6604	Hex Head Cap Screws, pack of 15	1/4" - 20	2"	PK	1
6605	Hex Head Cap Screws, pack of 12	1/4" - 20	2-1/2"	PK	1
6622	Hex Head Cap Screws, pack of 15	5/16" - 18	1"	PK	1
6623	Hex Head Cap Screws, pack of 12	5/16" - 18	1-1/2"	PK	1
6641	Hex Head Cap Screws, pack of 14	3/8" - 16	3/4"	PK	1
6642	Hex Head Cap Screws, pack of 12	3/8" - 16	1"	PK	1
6643	Hex Head Cap Screws, pack of 8	3/8" - 16	1-1/2"	PK	1
6644	Hex Head Cap Screws, pack of 7	3/8" - 16	2"	PK	1
6645	Hex Head Cap Screws, pack of 5	3/8" - 16	2-1/2"	PK	1
6682	Hex Head Cap Screws, pack of 7	1/2" - 13	1"	PK	1
6683	Hex Head Cap Screws, pack of 5	1/2" - 13	1-1/2"	PK	1
6685	Hex Head Cap Screws, pack of 3	1/2" - 13	2-1/2"	PK	1

### Medium Split Lock Washers

Spring type. These washers are made of zinc plated steel.



CATALOG NO.	DESCRIPTION	SIZE	UOM	ORDER MULTIPLE
6730	Medium Split Lock Washers, pack of 95	3/16"	PK	1
6731	Medium Split Lock Washers, pack of 72	1/4"	PK	1
6732	Medium Split Lock Washers, pack of 59	5/16"	PK	1
6733	Medium Split Lock Washers, pack of 38	3/8"	PK	1
6735	Medium Split Lock Washers, pack of 18	1/2"	PK	1



## POWER CORDS AND WORK LIGHTS

## Round Extension Cords\*

Comes in bright orange or yellow, depending upon availability.



CATALOG NO.	DESCRIPTION	WIRE	LENGTH	RATING	UOM	ORDER MULTIPLE
5225	Round Extension Cord	16/3	25'	13A/125V	EA	1
5230	Round Extension Cord	14/3	100'	13A/125V	EA	1

## Trouble Lights\*

These all weather lights are extra flexible with metal guards.



CATALOG NO.	DESCRIPTION	WIRE	CORD LENGTH	RATING	UOM	ORDER MULTIPLE
5200	Trouble Light	16/3	25'	13A/125V	EA	1
5201	Trouble Light	16/3	50'	13A/125V	EA	1

## SCREWS

## Combo Head Sheet Metal Screws

These screws are used on sheet metal items.



CATALOG NO.	DESCRIPTION	LENGTH	SCREW SIZE	UOM	ORDER MULTIPLE
6822	Combo Head Screws, pack of 102	3/8"	#6	PK	1
6822DX	Combo Head Screws, pack of 500	3/8"	#6	PK	1
6823	Combo Head Screws, pack of 96	1/2"	#6	PK	1
6826DX	Combo Head Screws, pack of 500	1"	#6	PK	1
6843	Combo Head Screws, pack of 69	1/2"	#8	PK	1
6843DX	Combo Head Screws, pack of 500	1/2"	#8	PK	1
6845	Combo Head Screws, pack of 56	3/4"	#8	PK	1
6845DX	Combo Head Screws, pack of 500	3/4"	#8	PK	1
6846	Combo Head Screws, pack of 47	1"	#8	PK	1
6848	Combo Head Screws, pack of 36	1-1/2"	#8	PK	1
6849	Combo Head Screws, pack of 26	2"	#8	PK	1
6853	Combo Head Screws, pack of 48	1/2"	#10	PK	1
6855	Combo Head Screws, pack of 46	3/4"	#10	PK	1
6858	Combo Head Screws, pack of 26	1-1/2"	#10	PK	1
6859	Combo Head Screws, pack of 19	2"	#10	PK	1
6863	Combo Head Screws, pack of 38	1/2"	#12	PK	1
6865	Combo Head Screws, pack of 32	3/4"	#12	PK	1
6866	Combo Head Screws, pack of 26	1"	#12	PK	1
6868	Combo Head Screws, pack of 18	1-1/2"	#12	PK	1
6876	Combo Head Screws, pack of 20	1"	#14	PK	1
6877	Combo Head Screws, pack of 16	1-1/4"	#14	PK	1
6878	Combo Head Screws, pack of 15	1-1/2"	#14	PK	1

## Self-Drilling Screw Repair Kit

These screws are used for replacements in striped holes.



CATALOG NO.	DESCRIPTION	UOM	ORDER MULTIPLE
6900AX	Contains: #12 x 3/4", #12 x 1", #14 x 3/4", #14 x 1"	EA	1

## Sheet Metal Screw Assortments

6800BX and 6800HX come in a four compartment, clear plastic box.



CATALOG NO.	DESCRIPTION	UOM	ORDER MULTIPLE
6800A	Combo Head Screws: #8 x 1/2", #8 x 3/4", #10 x 3/4", #10 x 1"	EA	1
6800BX	Combo Head Screws: #6 x 3/8", #8 x 1/2", #8 x 3/4", #10 x 3/4", #10 x 1"	EA	1
6800HX	Slotted Hex Washer Head Screws: #6 x 3/8", #8 x 1/2", #8 x 3/4", #10 x 3/4", #10 x 1"	EA	1

## Slotted Round Head Machine Screws – Assortments

The assortment is zinc plated steel and offers a variety of sizes.



CATALOG NO.	DESCRIPTION	SIZES	LENGTHS	UOM	ORDER MULTIPLE
6020	Slotted Round Head Machine Screws, pack of 81	#6-32	1/2", 1", 2"	PK	1
6030	Slotted Round Head Machine Screws, pack of 61	#8-32	1/2", 1", 2"	PK	1
6040	Slotted Round Head Machine Screws, pack of 53	#10-32	1/2", 1", 2"	PK	1
6021	Slotted Round Head Machine Screws, #6-32, #8-32, #10-32	#6-32, #8-32, #10-32	1/2", 1", 2"	PK	1

## Self-Drilling Screws

Zinc plated steel. Self drilling screws drill and tap holes in one step. Hex washer heads. #8 and #10 screws are designed for use with material thickness of .035" to .110"; #12 and #14 screws are designed for use with .110" to .220" material thickness.



CATALOG NO.	DESCRIPTION	UOM	ORDER MULTIPLE
6943CX	Hex Head Self Drilling Screw, 1/4in. Head #8 x 1/2in., 100 pcs	EA	1
6945CX	Hex Head Self Drilling Screw, Zinc Plated, #8 x 3/4in., 100 pcs	EA	1
6946CX	Hex Head Self Drilling Screw, 1/4in. Head #8 x 1in, 100 pcs	EA	1
6953CX	Hex Washer Head Self Drilling Screws 5/16in. Head #10 x 1/2in 100 pcs	EA	1
6955CX	Hex Head Self Drilling Screw, 5/16in. Head #10 x 3/4in., 100 pcs	EA	1
6956CX	Hex Washer Head Self Drilling Screws 5/16in. Head #10 x 1in 100 pcs	EA	1

\*Items in this section are Underwriter's Laboratories listed or recognized under the prime manufacturer's name.



## SPECIALTY FASTENERS

### Nylon Cable Clamps

These cable clamps are perfect for securing wire or pipes.



CATALOG NO.	DESCRIPTION	FITS PIPE OUTER DIAMETER	THICKNESS	WIDTH	UOM	ORDER MULTIPLE
5381	Nylon Cable Clamps, pack of 54	1/8"	.050"	3/8"	PK	1
5382	Nylon Cable Clamps, pack of 48	1/4"	.050"	3/8"	PK	1
5383	Nylon Cable Clamps, pack of 41	3/8"	.050"	3/8"	PK	1
5384	Nylon Cable Clamps, pack of 35	1/2"	.050"	3/8"	PK	1
5385	Nylon Cable Clamps, pack of 21	5/8"	.060"	1/2"	PK	1
5386	Nylon Cable Clamps, pack of 19	3/4"	.060"	1/2"	PK	1
5387	Nylon Cable Clamps, pack of 18	7/8"	.060"	1/2"	PK	1
5380AX	Assortment	1/8" - 1"			EA	1

### Pipe Hanging Strap

Non plated Steel Pipe hanging Strap is perfect for hanging pipes, fastening faucets and valves, as well as repair jobs.



CATALOG NO.	DESCRIPTION	SIZE	UOM	ORDER MULTIPLE
PI335	Pipe Hanging Strap; 28 gauge AWG	3/4" x 10'	EA	1

### Nylon Nut and Washer

Nylon Bolts and washers are suitable where non conductivity, corrosion resistance, and cost are important considerations.



CATALOG NO.	DESCRIPTION	WASHER DIAMETER INNER	WASHER DIAMETER OUTER	THREAD SIZE	UOM	ORDER MULTIPLE
6513	Nylon Nut and Washer, pack of 6	7/16"	3/4"	3/8"-16	PK	1
6515	Nylon Nut and Washer, pack of 4	1/2"	3/4"	1/2"-13	PK	1

### Set Screws

Set Screws have cup points and hex socket heads. Class 3A threads. Made of heat treated alloy steel.



CATALOG NO.	DESCRIPTION	SIZE	UOM	ORDER MULTIPLE
6002	Set Screws, pack of 33	#8-32 x 3/16"	PK	1
6003	Set Screws, pack of 25	#10-32 x 3/16"	PK	1
6004	Set Screws, pack of 27	1/4"-28 x 1/4"	PK	1
6005	Set Screws, pack of 27	1/4"-20 x 1/4"	PK	1
6006	Set Screws, pack of 19	5/16"-18 x 5/16"	PK	1
6007	Set Screws, pack of 14	3/8"-16 x 3/8"	PK	1
6000	Large Assortment; course thread	1/4"-20; 5/16"-18; 3/8"-16	EA	1
6001	Small Assortment; fine thread	#8-32; #10-32; 1/4"-28	EA	1

### Hose Clamps

Hose Clamps have stainless steel housings and bands. The screws are plated steel and have slotted hex heads allowing a socket wrench, nut driver, or screwdriver to be used.



CATALOG NO.	DESCRIPTION	SAE NO.	SAE DIAMETER RANGE (in.)	APPROX. RANGE (in.)	UOM	ORDER MULTIPLE
HC6202	Hose Clamps, pack of 6	*	N/A	1/4 to 5/8	PK	1
HC6203	Hose Clamps, pack of 6	6	.44 - .78	5/16 to 7/8	PK	1
HC5410	Hose Clamps, pack of 6	10	.56 - 1.06	9/16 to 1-1/8	PK	1
HC5410X	Hose Clamps, pack of 10	10	.56 - 1.06	9/16 to 1-1/8	PK	1
HC5416	Hose Clamps, pack of 6	16	.81 - 1.50	3/4 to 1-1/2	PK	1
HC5416X	Hose Clamps, pack of 10	16	.81 - 1.50	3/4 to 1-1/2	PK	1
HC5420	Hose Clamps, pack of 6	20	.81 - 1.75	13/16 to 1-3/4	PK	1
HC5420X	Hose Clamps, pack of 10	20	.81 - 1.75	13/16 to 1-3/4	PK	1
HC5424	Hose Clamps, pack of 6	24	1.06 - 2.00	1-1/16 to 2	PK	1
HC5436	Hose Clamps, pack of 4	36	1.81 - 2.75	1-1/2 to 2-3/4	PK	1
HC5436X	Hose Clamps, pack of 10	36	1.81 - 2.75	1-1/2 to 2-3/4	PK	1

### Nylon Rods

These nylon rods can be used with load bearing capability. Used for smaller machined parts, such as electrical insulators and food contact parts.

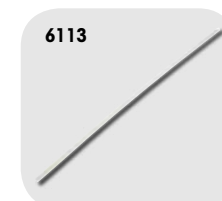

CATALOG NO.	DESCRIPTION	DIAMETER	THREADS (in.)	LENGTH	UOM	ORDER MULTIPLE
6113	Nylon Rods; All-Thread, pack of 4	3/8"	16	2'	PK	1
6115	Nylon Rods; All-Thread, pack of 2	1/2"	13	2'	PK	1

### Cotter Pins

Cotter Pins provide smooth locking between two parts. This set includes an assortment of regular Cotter Pins with extended prongs.



CATALOG NO.	DESCRIPTION	UOM	ORDER MULTIPLE
6011	Cotter Pins: 1/16" x 1-1/2"; 3/32" x 1-1/2"; 1/8" x 1-1/2", pack of 51	PK	1

### Motor Shaft Key Assortments

You can use choose from either a large assortment or a small assortment. The keys are made of cold rolled 1018 steel and are zinc plated.



CATALOG NO.	DESCRIPTION	UOM	ORDER MULTIPLE
6101	Small Assortment includes: 1/8" x 1/8" x 1-3/16"; 3/16" x 3/16" x 1-3/16"; 3/16" x 1/4" x 1-3/16"; 1/4" x 1/4" x 1-3/4"	EA	1
6102	Large Assortment includes: 1/4" x 1/4" x 1-3/4"; 5/16" x 5/16" x 3"; 3/8" x 3/8" x 3	EA	1



## SPECIALTY FITTINGS

## Grease Fittings

Case hardened steel fittings plated with yellow dip chromate and built-in ball checks. Assortment available in clear plastic box.



CATALOG NO.	DESCRIPTION	UOM	ORDER MULTIPLE
6311	Grease Fittings: 1/4"-28 Tapered Thread; straight, pack of 8	PK	1
6312	Grease Fittings: 1/8" Pipe Thread; straight, pack of 5	PK	1
6313	Grease Fittings: 1/4" Pipe Thread; straight, pack of 2	PK	1
6321	Grease Fittings: 1/4"-28 Tapered Thread; 90°, pack of 3	PK	1
6322	Grease Fittings: 1/8" Pipe Thread; 90°, pack of 3	PK	1
6310X	Assortment includes: 6311, 6312, 6321, 6322	EA	1

## SPECIALTY TOOLS

## Radiator Vent Keys

Comes in a set of four and can be used on radiators and water heaters.



## Precision Screwdriver Set

This set of six screwdrivers is a perfect addition to any toolbox. The set includes slotted sizes 1.4mm, 2.0 mm, 2.4mm, and 3.0mm along with Phillips sizes of #0 and #1.

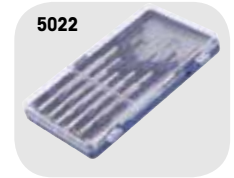

CATALOG NO.	DESCRIPTION	UOM	ORDER MULTIPLE
DE22	Radiator Vent Keys, pack of 4	PK	1

CATALOG NO.	DESCRIPTION	UOM	ORDER MULTIPLE
5022	Set of 6 Precision Screwdrivers	EA	1

## STORAGE CONTAINERS

## Metal Parts Boxes

Metal Parts Boxes are prime cold rolled steel with baked gray enamel finish. The finish is rust and acid resistant. Each box comes with high impact plastic tray, positive pull down catch, and stick back parts labels for lid interiors.



## Satchel Style Case

Parts box made from rugged copolymer material with high impact translucent lid and handle on the side. 15 removable dividers allow up to 24 compartments.

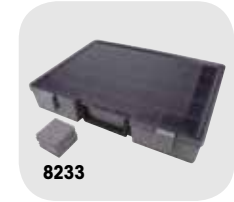

CATALOG NO.	DESCRIPTION	NO. OF COMPARTMENTS	DIMENSIONS (L x W x D)	UOM	ORDER MULTIPLE
8200M	Metal Parts Box	21	13-3/8" x 9-1/4" x 2"	EA	1
8220M	Metal Parts Box	24	18" x 12" x 3"	EA	1

CATALOG NO.	DESCRIPTION	NO. OF COMPARTMENTS	DIMENSIONS (L x W x D)	UOM	ORDER MULTIPLE
8233	Satchel Style Case	Up to 24	15" x 11-3/4" x 2-1/2"	EA	1

## Styrene Parts Boxes

This box is ideal for holding your different sized nuts and bolts along with your additional bits. It can be stored in a tool box as well.



## Polypropylene Parts Boxes

This box is ideal for holding your different sized nuts and bolts along with your additional bits. It can be stored in a tool box as well.

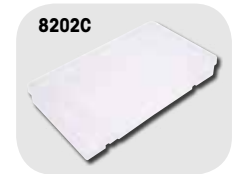

CATALOG NO.	DESCRIPTION	COLOR	NO. OF COMPARTMENTS	DIMENSIONS (L x W x D)	UOM	ORDER MULTIPLE
8206	Styrene Parts Box	Clear	1	4-7/8" x 3-1/4" x 1-1/8"	EA	1
8207	Styrene Parts Box	Clear	4	4-7/8" x 3-1/4" x 1-1/8"	EA	1
8208	Styrene Parts Box	Clear	6	4-7/8" x 3-1/4" x 1-1/8"	EA	1

CATALOG NO.	DESCRIPTION	COLOR	NO. OF COMPARTMENTS	DIMENSIONS (L x W x D)	UOM	ORDER MULTIPLE
8201	Polypropylene Parts Box	Yellow	13	11" x 6-3/4" x 1-1/4"	EA	1
8201C	Polypropylene Parts Box Translucent		13	11" x 6-3/4" x 1-1/4"	EA	1
8202	Polypropylene Parts Box	Yellow	18	11" x 6-3/4" x 1-1/4"	EA	1
8202C	Polypropylene Parts Box Translucent		18	11" x 6-3/4" x 1-1/4"	EA	1
8203	Polypropylene Parts Box	Yellow	24	11" x 6-3/4" x 1-1/4"	EA	1
8203C	Polypropylene Parts Box Translucent		24	13-1/8" x 9" x 2-5/8"	EA	1

## TAPES

### Tape

Vinyl electrical tape. Part 5247 holds up to 7 pounds per square inch when attached to steel surface.



CATALOG NO.	DESCRIPTION	LENGTH	UOM	ORDER MULTIPLE
5255	Vinyl Electrical Tape	3/4" x 60'	EA	1

### Teflon® Tape

This PTFE Tape is made of non toxic, pure white PTFE. The tape can be used with chemicals, solvents, oxygen, and on food lines. The product can withstand up to 2000 psi of pressure.



CATALOG NO.	DESCRIPTION	LENGTH	UOM	ORDER MULTIPLE
5246	Teflon® Thread Seal Tape	1/2" x 520"	EA	1

## TESTERS, LEADS, CLIPS, FUSES

### Testers

Our testers are designed to test for AC or DC live volts and continuity.



CATALOG NO.	DESCRIPTION	UOM	ORDER MULTIPLE
EM217	Low Voltage Tester tests 5-50 volts AC or DC; attached alligator clips	EA	1
EM469	Continuity Tester tests cold circuits without external power source; uses 2 AA batteries; 26" test lead with alligator probe	EA	1

### Clips

The clips are alligator clips and have vinyl red and black insulators.



CATALOG NO.	DESCRIPTION	UOM	ORDER MULTIPLE
5033	Steel Alligator Clips for use with test probes (.075"-.080"); 1-31/32" long; jaws open 5/16" max.; pack of 2 red, 2 black, 4 clips	PK	1
5035	Copper Alligator Clips; 1-31/32" long; jaws open 5/16" max.; crimper slotted screw connection, pack of 2 red, 2 black, 4 clips	PK	1
5036	Steel Test Clips; 20A, 2-7/16" long; jaws open 5/8" max.; crimper slotted screw connection, pack of 1 red, 1 black, 2 clips	PK	1

### Blade (Auto) Fuses

These fuses are used to protect circuits in the wiring harness that are usually found under the hood, in a fuse panel or supplementary panel near the battery. MAX fuses are used in domestic and import vehicles.



CATALOG NO.	DESCRIPTION	UOM	ORDER MULTIPLE
ED-AT3	Blade Fuse – 3 Amp – Purple, pack of 10	PK	1
ED-AT5	Blade Fuse – 5 Amp – Tan, pack of 10	PK	1

### Test Leads

These are replacement leads.



CATALOG NO.	DESCRIPTION	UOM	ORDER MULTIPLE
5031	Low Voltage Test Leads; eight 22" long, color-coded leads with fully insulated alligator clips	EA	1
5041	Small Hook Type Low Voltage Test Leads; retractable hooks, 36" thermoplastic 22 gauge wire, nylon body/plunger, red/black	EA	1
5042	Large Hook Type Low Voltage Test Leads; retractable hooks, 36" PVC insulated 20 gauge wire, nylon body/plunger, red/black	EA	1
5045	Instrument Test Lead Adapter fits a standard .080" tip jack to an alligator clip; 6" lead	EA	1
5046	Flexible Test Leads; steel alligator clips with vinyl red and black insulators; 36" 20 gauge wire; extremely flexible	EA	1

### Dual Element Fuses – 250V

Provides time delay for temporary over-current conditions and motor running protection for heating and air conditioning equipment. Eliminates unnecessary maintenance from harmless overloads.



CATALOG NO.	DESCRIPTION	UOM	ORDER MULTIPLE
ED-CR15	Dual Element Fuse – 15 Amps, pack of 2	PK	1
ED-CR20	Dual Element Fuse – 20 Amps, pack of 2	PK	1
ED-CR25	Dual Element Fuse – 25 Amps, pack of 2	PK	1
ED-CR30	Dual Element Fuse – 30 Amps, pack of 2	PK	1
ED-CR35	Dual Element Fuse – 35 Amps, pack of 2	PK	1
ED-CR40	Dual Element Fuse – 40 Amps, pack of 2	PK	1
ED-CR45	Dual Element Fuse – 45 Amps, pack of 2	PK	1
ED-CR50	Dual Element Fuse – 50 Amps, pack of 2	PK	1
ED-CR60	Dual Element Fuse – 60 Amps, pack of 2	PK	1

U.L. Class RK-5, Standard for Safety 198E, Current Limiting Fuses, Interrupting Rating 200,000 Amps. rms. A.C.



## WIRE

## TFFN Stranded Hook-Up Wire\*

Packaged in handy dispenser bag. Polyvinyl chloride insulation. Wire rating: 600V, 90°C. Insulation: oil resistant nylon coating.

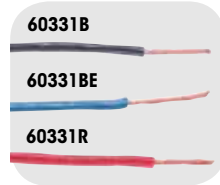

CATALOG NO.	COLOR	GAUGE	STRANDS	O.D.	LENGTH	UOM	ORDER MULTIPLE
60331B	Black, pack of 50'	18	16	.09"	48'	PK	1
60331BE	Blue, pack of 50'	18	16	.09"	48'	PK	1
60331GY	Gray, pack of 50'	18	16	.09"	48'	PK	1
60331P	Pink, pack of 50'	18	16	.09"	48'	PK	1
60331R	Red, pack of 50'	18	16	.09"	48'	PK	1
60331W	White, pack of 50'	18	16	.09"	48'	PK	1
6332B	Black, pack of 50'	16	26	.10"	48'	PK	1
6332G	Green, pack of 50'	16	26	.10"	48'	PK	1
6332R	Red, pack of 50'	16	26	.10"	48'	PK	1
6332W	White, pack of 50'	16	26	.10"	48'	PK	1

## Thermostat Wire\*

Thermoplastic insulated, jacketed wire for low voltage applications. Conductors are solid copper, individually insulated and color coded.

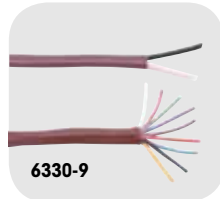

CATALOG NO.	DESCRIPTION	CONDUCTORS	WIRE GAUGE	LENGTH	UOM	ORDER MULTIPLE
6331	Thermostat Wire, pack of 40'	2	20	40'	PK	1
6336	Thermostat Wire, pack of 40'	3	20	40'	PK	1
6330-4	Thermostat Wire, pack of 40'	4	20	40'	PK	1
6337	Thermostat Wire, pack of 40'	5	20	40'	PK	1
6330-6	Thermostat Wire, pack of 40'	6	20	40'	PK	1
6338	Thermostat Wire, pack of 40'	8	20	40'	PK	1
6330-9	Thermostat Wire, pack of 40'	9	20	40'	PK	1
6339	Thermostat Wire, pack of 25'	10	20	25'	PK	1
6339XL	Thermostat Wire, pack of 40'	10	20	40'	PK	1

## High Temperature Range Wire\*

200°C glass braided, three conductor twisted wire. 600V; silicone rubber insulated. This product also contains a crimper.



CATALOG NO.	COLOR	WIRE GAUGE	LENGTH	UOM	ORDER MULTIPLE
6383-35	Black, Red, and White, pack of 5'	14	5'	PK	1
6383-325	Black, Red, and White, pack of 25'	14	25'	PK	1
6384-35	Black, Red, and White, pack of 5'	12	5'	PK	1
6384-325	Black, Red, and White, pack of 25'	12	25'	PK	1

## THHN Stranded Hook-Up Wire\*

Packaged in handy dispenser bag. Polyvinyl chloride insulation. Wire rating: 600V, 90°C. Insulation: oil resistant nylon coating.

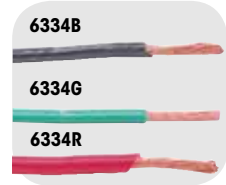

CATALOG NO.	COLOR	GAUGE	STRANDS	O.D.	LENGTH	UOM	ORDER MULTIPLE
6333B	Black, pack of 50'	14	19	.11"	48'	PK	1
6333G	Green, pack of 50'	14	19	.11"	48'	PK	1
6333R	Red, pack of 50'	14	19	.11"	48'	PK	1
6333W	White, pack of 50'	14	19	.11"	48'	PK	1
6334B	Black, pack of 50'	12	19	.13"	48'	PK	1
6334G	Green, pack of 50'	12	19	.13"	48'	PK	1
6334R	Red, pack of 50'	12	19	.13"	48'	PK	1
6334W	White, pack of 50'	12	19	.13"	48'	PK	1
6335B	Black, pack of 50'	10	19	.17"	48'	PK	1
6335G	Green, pack of 50'	10	19	.17"	48'	PK	1
6335R	Red, pack of 50'	10	19	.17"	48'	PK	1
6335W	White, pack of 50'	10	19	.17"	48'	PK	1
6360B	Black, pack of 50'	8	19	.22"	25'	PK	1
6360R	Red, pack of 50'	8	19	.22"	25'	PK	1
6360W	White, pack of 50'	8	19	.22"	25'	PK	1

## SJTO Service Cord\*

Features stranded bare copper, PVC insulation; PVC jacket. Cord is oil resistant. Cords have 3 individually insulated conductors. Ratings: 300V; 60°C.

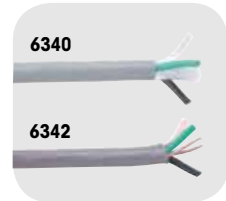

CATALOG NO.	DESCRIPTION	WIRE GAUGE	LENGTH	UOM	ORDER MULTIPLE
6340	SJTO Service Cord, pack of 12'	16	12'	PK	1
6341	SJTO Service Cord, pack of 20'	16	20'	PK	1
6342	SJTO Service Cord, pack of 12'	14	12'	PK	1
6343	SJTO Service Cord, pack of 20'	14	20'	PK	1

## Stranded High Temperature Wire\*

Thermoplastic equipment insulated wire. CSA listed at 105°C; 600V. Insulation thickness: .03". MTW/AWM/TEW



CATALOG NO.	COLOR	GAUGE	STRANDS	O.D.	LENGTH	UOM	ORDER MULTIPLE
6361B	Black, pack of 48'	18	16	.113"	48'	PK	1
6361R	Red, pack of 48'	18	16	.113"	48'	PK	1
6361W	White, pack of 48'	18	16	.113"	48'	PK	1
6362B	Black, pack of 48'	16	26	.125"	48'	PK	1
6362R	Red, pack of 48'	16	26	.125"	48'	PK	1
6362W	White, pack of 48'	16	26	.125"	48'	PK	1
6363B	Black, pack of 48'	14	19	.139"	48'	PK	1
6363R	Red, pack of 48'	14	19	.139"	48'	PK	1
6363W	White, pack of 48'	14	19	.139"	48'	PK	1
6364B	Black, pack of 48'	12	19	.158"	48'	PK	1
6364R	Red, pack of 48'	12	19	.158"	48'	PK	1
6364W	White, pack of 48'	12	19	.158"	48'	PK	1
6365B	Black, pack of 48'	10	19	.182"	48'	PK	1
6365R	Red, pack of 48'	10	19	.182"	48'	PK	1
6365W	White, pack of 48'	10	19	.182"	48'	PK	1

\*Items in this section are Underwriter's Laboratories listed or recognized under the prime manufacturer's name.

**WIRING DEVICES**

**Thermoplastic Handle Plug\***

This plug is a standard grade with flexible spring prongs and is furnished with a face washer. This product's rating is a 15A 125V and also contains a crimper.



CATALOG NO.	DESCRIPTION	MAX. CORD DIAMETER	POLES	WIRES	MATERIAL	UOM	ORDER MULTIPLE
ED179	Handle Plug	.406"	2	2	Thermoplastic	EA	2

**Grounding Rubber Handle Plug\***

The rubber back design allows for sure grip and protection against dirt and moisture entry. This plug is designed to operate in the widest possible temperature ranges.



CATALOG NO.	DESCRIPTION	FITS CORD DIAMETER	POLES	WIRES	RATING	UOM	ORDER MULTIPLE
ED1703	Grounding Handle Plug	.25"-.60"	2	3	20A-250V	EA	1
ED1709	Grounding Handle Plug	.25"-.60"	2	3	15A-125V	EA	1

**Tandem Grounding Rubber Handle Plug\***

The rubber back design allows for sure grip and protection against dirt and moisture entry. This plug is designed to operate in the widest possible temperature ranges



CATALOG NO.	DESCRIPTION	FITS CORD DIAMETER	POLES	WIRES	RATING	UOM	ORDER MULTIPLE
ED1711	Tandem Handle Plug	.25"-.60"	2	3	15A-250V	EA	1

**Armored Plug\***

This plug has a round dead front and is vinyl enclosed.



CATALOG NO.	DESCRIPTION	FITS CORD DIAMETER	POLES	WIRES	RATING	UOM	ORDER MULTIPLE
ED2867	Armored Plug	.25"-.625"	2	3	15A-125V	EA	1

**Right Angle Plug\***

Our right angle plug is ergonomically designed fluted body with radial gripping ridge creates an ideal surface for gripping and pulling.



CATALOG NO.	DESCRIPTION	FITS CORD DIAMETER	POLES	WIRES	RATING	UOM	ORDER MULTIPLE
ED4409	Right Angle Plug	.25"-.655"	2	3	20A-125V	EA	1
ED4509	Right Angle Plug	.25"-.655"	2	3	20A-250V	EA	1
ED4867	Right Angle Plug	.25"-.655"	2	3	15A-125V	EA	1

**Rubber Connector\***

This is a standard grade rubber connector with a 3 pole opening.



CATALOG NO.	DESCRIPTION	FITS CORD DIAMETER	POLES	WIRES	RATING	UOM	ORDER MULTIPLE
ED252	Rubber Connector	.25"-.60"	2	3	15A-125V	EA	1

**Armored Connector\***

The Armor Connector is ideal for shops, garages, and heavier duty work areas. Vinyl enclosed.



CATALOG NO.	DESCRIPTION	FITS CORD DIAMETER	POLES	WIRES	RATING	UOM	ORDER MULTIPLE
ED2887	Armored Connector	.225"-.60"	2	3	15A-125V	EA	1

**Ground Adapter\***

This adapter is polarized with 2 pole to 3 wire grounding. The body is made of polypropylene.



CATALOG NO.	DESCRIPTION	RATING	UOM	ORDER MULTIPLE
ED419	Ground Adapter	15A-125V	EA	2

\*Items in this section are Underwriter's Laboratories listed or recognized under the prime manufacturer's name.



## WIRING DEVICES cont'd

## Triple Outlets\*

These outlets are polarized and are made of high impact resistant plastic.



CATALOG NO.	DESCRIPTION	RATING	UOM	ORDER MULTIPLE
5223	Heavy duty, 2 pole, 3 wire	15A-125V	EA	1
5223B	Heavy duty, 2 pole, 3 wire	15A-125V	EA	25
5224	2 pole, 2 wire	15A-125V	EA	1

## Receptacles\*

Our receptacles are available in either singles or duplexes. This is a 2 pole, 3 wire product with ground included. Standard Grade.



CATALOG NO.	DESCRIPTION	RATING	COLOR	UOM	ORDER MULTIPLE
ED1876	Single Receptacle	20A-250V	Brown	EA	1
ED1876-I	Single Receptacle	20A-250V	Ivory	EA	1
ED1877	Single Receptacle	20A-125V	Brown	EA	1
ED270**	Duplex Receptacle	15A-125V	Brown	EA	1
ED270-I**	Duplex Receptacle	15A-125V	Ivory	EA	1
ED877	Duplex Receptacle	20A-125V	Brown	EA	1
ED877-I	Duplex Receptacle	20A-125V	Ivory	EA	1

\*\*Standard Grade

## Metal Bat Handle Toggle Switches\*

Features black phenolic plastic case; brass terminals; steel and zinc chromate frame and support; all other external parts are brass/bright nickel. These heavy duty toggle switches have screw terminals. Part ED447 has an "ON-OFF" face plate.

Specifications: 10A/277V-20A/125V AC

Single Pole: 3/4HP 125-250V AC

Double Pole: 1-1/2HP 125-250V AC



CATALOG NO.	DESCRIPTION	SEQUENCE	CIRCUIT	UOM	ORDER MULTIPLE
ED447	Bat Handle Toggle Switch	ON-OFF	Single Pole, Single Throw	EA	1
ED453	Bat Handle Toggle Switch	ON-ON	Double Pole, Double Throw	EA	1
ED454	Bat Handle Toggle Switch	ON-ON	Single Pole, Double Throw	EA	1
ED455	Bat Handle Toggle Switch	ON-OFF	Double Pole, Single Throw	EA	1
ED468	Bat Handle Toggle Switch	ON-OFF-ON	Single Pole, Double Throw	EA	1
ED494	Bat Handle Toggle Switch	ON-OFF-ON	Double Pole, Double Throw	EA	1

## Toggle Switch with Neon Pilot Light Combination Device\*

Switch: 15A-120V AC

Neon Pilot Light: 1/25W, 120V AC



CATALOG NO.	DESCRIPTION	UOM	ORDER MULTIPLE
ED277	Toggle Switch with Neon Pilot Light - Brown Body	EA	1
ED277-I	Toggle Switch with Neon Pilot Light - Ivory Body	EA	1

## Power Supply Replacement Cords\*

For power tools or appliances. Black vinyl cord is flexible in very cold environments. Wire type is SJEW-A.



CATALOG NO.	DESCRIPTION	WIRE	RATING	LENGTH	UOM	ORDER MULTIPLE
5240	Black Replacement Cord	16/3	13A/125V	10'	EA	1
5242	Black Replacement Cord	14/3	15A/125V	10'	EA	1

## Toggle Switch and Receptacle Combination Device\*

This device is a single pole switch with 15A 120V AC. The receptacle is 15A 125V AC and it is a 2 pole, three wire grounding.



CATALOG NO.	DESCRIPTION	UOM	ORDER MULTIPLE
ED5225	Toggle Switch and Receptacle - Brown Body	EA	1

## Toggle Switches\*

Our toggle switch is a silent switch with ground included. Standard Grade.



CATALOG NO.	DESCRIPTION	RATING	COLOR	UOM	ORDER MULTIPLE
ED1240-2	Single Pole	15A-120/277V AC	Brown	EA	1
ED1238	Single Pole	20A-120/277V AC	Brown	EA	1
ED1301**	Single Pole	15A-120V AC	Brown	EA	1
ED1301-I**	Single Pole	15A-120V AC	Ivory	EA	1
ED1262-2	Double Pole	15A-120/277V AC	Brown	EA	1
ED1262-2I	Double Pole	15A-120/277V AC	Ivory	EA	1
ED1232	Double Pole	30A-120/277V AC	Brown	EA	1

\*\*Standard Grade

## Porcelain Outlet Box Lampholders\*

Features one-piece pull chain. Two screw terminals, 2 pole, 2 wire. 4-1/2" outer diameter. These lamp-holders fit 3-1/4" and 4" boxes. Rating: Lampholder: 660W/125V. Outlet: 15A/125V.



CATALOG NO.	DESCRIPTION	UOM	ORDER MULTIPLE
ED9726	Porcelain Outlet Box Lampholder - U ground outlet	EA	1

## WIRING DEVICES cont'd

### Utility Fuse Outlets\*

This is designed to break up electrical surges on equipment.



CATALOG NO.	DESCRIPTION	UOM	ORDER MULTIPLE
<b>PI380</b>	Utility Fuse Outlet with Cover; 3/4HP-125V AC only; galvanized steel construction	EA	1
<b>PI381</b>	Utility Fuse Outlet and Switch with Cover; 1/2HP-125V AC only; galvanized steel construction	EA	1

### Vinyl Grommets

These grommets exhibit high dielectric strength and are oil, ozone, and UV resistant. Durometer hardness 60 shore "A".

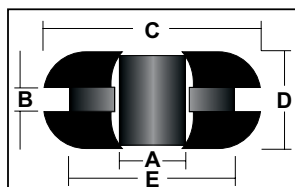

CATALOG NO.	DESCRIPTION	A (in.)	B (in.)	C (in.)	D (in.)	E (in.)	UOM	ORDER MULTIPLE
<b>ED302</b>	Grommet, pack of 15	3/16	1/16	7/16	7/32	5/16	PK	1
<b>ED304</b>	Grommet, pack of 14	1/4	1/16	9/16	1/4	3/8	PK	1
<b>ED312</b>	Grommet, pack of 6	25/64	1/8	27/32	3/8	21/32	PK	1

### 6180 Series Terminal Blocks\*

These terminal blocks are constructed of high barrier thermoplastic are rated 20A 250V.



CATALOG NO.	DESCRIPTION	NO. OF POSITIONS	LENGTH (in.)	WIDTH (in.)	SCREW SIZE	MAX. WIRE SIZE	UOM	ORDER MULTIPLE
<b>6182</b>	Terminal Block	4	2.16	.88	6-32	22-14	EA	1
<b>6183</b>	Terminal Block	6	2.91	.88	6-32	22-14	EA	1
<b>6184</b>	Terminal Block	8	3.66	.88	6-32	22-14	EA	1
<b>6185</b>	Terminal Block	10	4.41	.88	6-32	22-14	EA	1
<b>6186</b>	Terminal Block	12	5.16	.88	6-32	22-14	EA	1
<b>6187</b>	Terminal Block	14	5.91	.88	6-32	22-14	EA	1

### Terminal Block Jumpers\*

These jumpers connect two positions on a terminal block and are made of nickel plated brass.



CATALOG NO.	DESCRIPTION	UOM	ORDER MULTIPLE
<b>6278CX</b>	Jumpers for Terminal Block 6180 Series, pack of 100	PK	1
<b>6279</b>	Jumpers for Terminal Block 6190 Series, pack of 5	PK	1
<b>6279CX</b>	Jumpers for Terminal Block 6190 Series, pack of 100	PK	1

### Fuse Holders

Used to mount and protect fuses, fuse holders also enable fuses to be changed quickly and easily. Fuse holders are used in a variety of applications, including consumer electronics, industrial, telecom and datacom, automotive, and many others.



CATALOG NO.	DESCRIPTION	UOM	ORDER MULTIPLE
<b>EM480</b>	In-Line Fuse Holder for use with 1-1/4 x 1/4" fuses up to 20 amps, 32 volts, 15" lead; 14 gauge red vinyl insulated wire	EA	1
<b>EM484</b>	Self-Stripping Fuse Holder mates with blade-type fuse .205 x .025". 18-14 AWG. Size: 1.37" L x .44" H x .95" W Max. Insulation Outer Diameter: .145"	EA	2

### Vinyl Grommet Assortment Packs

These grommets exhibit high dielectric strength and are oil, ozone, and UV resistant.



CATALOG NO.	DESCRIPTION	UOM	ORDER MULTIPLE
<b>ED320</b>	General Assortment - contains all grommet sizes	EA	1

### 6190 Series Terminal Blocks\*

These terminal blocks are constructed of phenolic 9/16in. centers. They are rated 30A 600V.



CATALOG NO.	DESCRIPTION	NO. OF POSITIONS	LENGTH (in.)	WIDTH (in.)	SCREW SIZE	MAX. WIRE SIZE	UOM	ORDER MULTIPLE
<b>6192</b>	Terminal Block	4	3.22	1.31	8-32	14-12	EA	1
<b>6193</b>	Terminal Block	6	4.34	1.31	8-32	14-12	EA	1
<b>6194</b>	Terminal Block	8	5.47	1.31	8-32	14-12	EA	1
<b>6195X</b>	Terminal Block	10	6.59	1.31	8-32	14-12	EA	1
<b>6197X</b>	Terminal Block	14	8.84	1.31	8-32	14-12	EA	1

### Heat Shrink Tubing\*

Heat Shrink Tubing is made of flame-retardant polyolefin. Thin walled, all purpose tubing. Rated 600V, 125°C. 2500 volts/mil. dielectric strength. Inert to fungus. Virtually unaffected by corrosives, common fluids, and solvents. Pieces are 6" in length.



CATALOG NO.	COLOR	INNER DIAMETER MAX SUPPLIED	MIN. RECOVERED	UOM	ORDER MULTIPLE
<b>6373</b>	Black & White, pack of 7	1/8"	1/16"	PK	1
<b>63076B</b>	Black, pack of 10	3/8"	3/16"	PK	1
<b>63077B</b>	Black, pack of 10	1/2"	1/4"	PK	1
<b>63078B</b>	Black, pack of 10	3/4"	3/8"	PK	1
<b>63079B</b>	Black, pack of 10	1"	1/2"	PK	1

\*Items in this section are Underwriter's Laboratories listed or recognized under the prime manufacturer's name.



## WIRING DEVICES cont'd

## Heat Shrink Tubing Assortments\*

Heat Shrink Tubing is made of flame-retardant polyolefin. Thin walled, all purpose tubing. Rated 600V, 125°C. 2500 volts/mil. dielectric strength. Inert to fungus. Virtually unaffected by corrosives, common fluids, and solvents. Pieces are 6" in length.

6370



CATALOG NO.	COLOR	INNER DIAMETER MAX SUPPLIED	MIN. RECOVERED	UOM	ORDER MULTIPLE
6370	Black & White, pack of 12	1/8", 1/4"	1/16", 1/8"	PK	1
6371	Black & White, pack of 7	1/8", 1/4", 3/8"	1/16", 1/8", 3/16"	PK	1
63070	Black, pack of 3	3/8" - 1/2"	3/16" - 1/4"	PK	1

## Indicator Lights\*

Terminals are tin plated brass. Wire leads are 22 AWG, 4.4-4.8" long, 1/2" stripped. .31" minimum diameter mounting.



ED710

CATALOG NO.	LENS COLOR	LENS MATERIAL	VOLTAGE	BULB TYPE	UOM	ORDER MULTIPLE
ED710	Red, pack of 2	Polycarbonate	105-125V AC	Neon	PK	1
ED711	Green, pack of 2	Polycarbonate	105-125V AC	Neon**	PK	1
ED712	Amber, pack of 2	Polycarbonate	105-125V AC	Neon	PK	1
ED713	Blue, pack of 2	Polycarbonate	105-125V AC	Neon†	PK	1
ED714	White, pack of 2	Polycarbonate	105-125V AC	Neon	PK	1

## Standard Wire Connectors\*

Connectors are color coded with spring inserts. Heat resistant (105°C) thermoplastic. Connectors are for copper to copper connections. Parts 6294 and 6296 can connect aluminum to aluminum and copper to aluminum (dry locations only).

6292



CATALOG NO.	DESCRIPTION	UOM	ORDER MULTIPLE
6291	Mini Gray Standard Wire Connectors, pack of 29	PK	1
6291CX	Mini Gray Standard Wire Connectors, pack of 100	PK	1
6292	Tiny Blue Standard Wire Connectors, pack of 25	PK	1
6292CX	Tiny Blue Standard Wire Connectors, pack of 100	PK	1
6293	Small Orange Standard Wire Connectors, pack of 20	PK	1
6293CX	Small Orange Standard Wire Connectors, pack of 100	PK	1
6294	Medium Yellow Standard Wire Connectors, pack of 18	PK	1
6294CX	Medium Yellow Standard Wire Connectors, pack of 100	PK	1
6296	Large Red Standard Wire Connectors, pack of 12	PK	1
6296CX	Large Red Standard Wire Connectors, pack of 100	PK	1
6298	X-Large Gray Standard Wire Connectors, pack of 6	PK	1
6298LX	X-Large Gray Standard Wire Connectors, pack of 50	PK	1
6295X	Assortment: Includes 6291, 6292, 6293, 6294, 6296	EA	1

## Indicator Lights

Terminals are tin plated brass. Wire leads are 22 AWG, 4.4-4.8" long, 1/2" stripped. Mounting will snap-fit into .500-.505 diameter hole in .020-.100" thick panels.

ED621



CATALOG NO.	LENS COLOR	LENS MATERIAL	VOLTAGE	BULB TYPE	UOM	ORDER MULTIPLE
ED600	Red, pack of 2	Polycarbonate	28V	Incandescent	PK	1
ED601	Green, pack of 2	Polycarbonate	28V	Incandescent	PK	1
ED602	Amber, pack of 2	Polycarbonate	28V	Incandescent	PK	1
ED603	Blue, pack of 2	Polycarbonate	28V	Incandescent	PK	1
ED604	White, pack of 2	Polycarbonate	28V	Incandescent	PK	1
ED610	Red, pack of 2	Nylon	105-125V AC	Neon	PK	1
ED611	Green, pack of 2	Polycarbonate	105-125V AC	Neon**	PK	1
ED612	Amber, pack of 2	Nylon	105-125V AC	Neon	PK	1
ED613	Blue, pack of 2	Polycarbonate	105-125V AC	Neon†	PK	1
ED620	Red, pack of 2	Polycarbonate	208-250V AC	Neon	PK	1
ED621	Green, pack of 2	Polycarbonate	208-250V AC	Neon**	PK	1
ED622	Amber, pack of 2	Polycarbonate	208-250V AC	Neon	PK	1
ED623	Blue, pack of 2	Polycarbonate	208-250V AC	Neon†	PK	1

## Winged Wire Connectors\*

Durable thermoplastic material. Flame retardant, abrasion resistant, non porous, and non corrosive. Expandable spring grips into the wire and adjusts itself to the wire size and shape so pre twisting is unnecessary. Even during temperature changes, they resist vibrations and retain holding power. Parts 8284 and 8286 are for use with copper to copper, aluminum to aluminum, and copper to aluminum (dry locations only).

8286



CATALOG NO.	DESCRIPTION	UOM	ORDER MULTIPLE
8284	Small Yellow Winged Wire Connectors, pack of 18	PK	1
8284CX-B	Small Yellow Winged Wire Connectors, pack of 100	PK	1
8286	Medium Red Winged Wire Connectors, pack of 14	PK	1
8286CX	Medium Red Winged Wire Connectors, pack of 100	PK	1
8286CX-B	Medium Red Winged Wire Connectors, pack of 100	PK	1
8282	X-Large Blue Winged Wire Connectors, pack of 6	PK	1
8282LX	X-Large Blue Winged Wire Connectors, pack of 50	PK	1

-B indicates boxed product. All other catalog numbers are poly bagged.

\*Items in this section are Underwriter's Laboratories listed or recognized under the prime manufacturer's name.

\*\*Neon bulb incorporates G2B lamp and resistor.

† Neon bulb incorporates T2B lamp and resistor.



**WIRING DEVICES cont'd**

**Porcelain Wire Connectors\***

For high temperature applications over 105°C (300 volts maximum). For stranded copper connections only.



CATALOG NO.	DESCRIPTION	UOM	ORDER MULTIPLE
4293	Small White Porcelain Wire Connectors, pack of 17	PK	1
4293CX	Small White Porcelain Wire Connectors, pack of 100	PK	1
4294	Medium White Porcelain Wire Connectors, pack of 15	PK	1
4294CX	Medium White Porcelain Wire Connectors, pack of 100	PK	1
4296	Large White Porcelain Wire Connectors, pack of 13	PK	1
4296CX	Large White Porcelain Wire Connectors, pack of 100	PK	1

**Electrolytic Copper Solderless Lugs\***

Our solder less lugs are manufactured from high strength pure electrolytic copper to insure both maximum strength and conductivity.



CATALOG NO.	DESCRIPTION	WIRE RANGE	AMP RATING	UOM	ORDER MULTIPLE
PI226	Small Lug for copper wire, pack of 6	10-14	25	PK	1
PI227	Medium Lug for copper wire, pack of 6	6-14	35-50	PK	1
PI228	Large Lug for copper wire, pack of 6	4-14	70	PK	1

**Pigtails**

The wire has a #10 spade on one end and a 10 32 x 3/8in. slotted round head screw on the other. This allows for easy positioning in the outlet box.

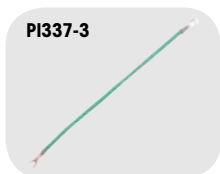

CATALOG NO.	DESCRIPTION	WIRE LENGTH	WIRE GAUGE	WIRE TYPE	UOM	ORDER MULTIPLE
PI337-3	Pigtails, pack of 5	8"	14	Stranded	PK	1

**Cable Markers**

Cable markers come in books of 450 markers with matching terminal markers. Markers are mounted on dispenser cards in the book. Cable markers are suitable for above and below ground applications. Books are made of vinyl impregnated cloth that resists moderate amounts of dirt, oil and heat. The blank Write-On Markers (WM1014) are made of durable vinyl film that resists water, oils, and fungus. They can also withstand extremes in temperature.



CATALOG NO.	DESCRIPTION	UOM	ORDER MULTIPLE
WM1002	Alpha-Numeric Cable Marker Book; contains 10 each: A-Z, 0-15, +, -, /	EA	1
WM1003	Numeric Cable Marker Book; contains 10 each: 1-45	EA	1
WM1009	Line and Terminal Cable Marker Book; contains 45 each: 1, 2, 3, A, B, C; contains 30 each: T1, T2, T3, L1, L2, L3	EA	1
WM1014	180 Blank Write-On Markers, 1/2" x 1-1/2"	EA	1

**Aluminum Solderless Lugs\***

Our aluminum solder less lug are made from high strength aluminum alloy. These lugs are suitable for use with either copper or aluminum conductors.



CATALOG NO.	DESCRIPTION	WIRE RANGE	AMP RATING	UOM	ORDER MULTIPLE
PI221	Small Lug for aluminum or copper wire, pack of 6	4-14	2	PK	1
PI222	Large Lug for aluminum or copper wire, pack of 6	2-14	2	PK	1

**Split Bolt Connectors\***

These connectors are made of silicone bronze and are designed for copper use only.



CATALOG NO.	DESCRIPTION	MAX. SOLID WIRE	MAX. STRANDED WIRE	UOM	ORDER MULTIPLE
PI326	Split Bolt Connector, pack of 3	10	12	PK	1
PI327	Split Bolt Connector, pack of 3	8	8	PK	1
PI328	Split Bolt Connector, pack of 3	6	7	PK	1
PI929	Split Bolt Connector, pack of 3	4	5	PK	1
PI930	Split Bolt Connector, pack of 3	2	3	PK	1

**Ground Fitting Clamp\***

A ground fitting clamp is ideal for surface mounting small amounts of electrical wiring or communication cables.



CATALOG NO.	DESCRIPTION	UOM	ORDER MULTIPLE
PI237	For 8, 6, 4 bare grounding wire; fits 1/2"-1" pipe	EA	1

\*Items in this section are Underwriter's Laboratories listed or recognized under the prime manufacturer's name.

# Do **MORE** with **DEVCO**®

*DEVCO products help you do even more for your customers. Offering a broad selection of the parts your contractors need to finish the job, DEVCO helps you provide them all the finishing touches they need for any project. So stock up today and do more with DEVCO.*

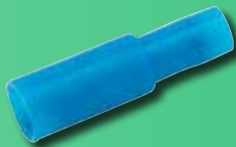

# ELECTRICAL

Bearings.....	133
Capacitors.....	138-140
Compressor Heaters .....	147
Conduit, Fittings, Cable .....	135-136
Contactors.....	141-142
DiversiTech Electrical Disconnects.....	135
Electrical Supplies .....	148-150
Electrical Tapes.....	150
Fan Centers.....	143
Fuses .....	144-145
Hard Start Kits .....	140
Monitors.....	146
Motor Brackets .....	133
Motor Run Capacitors (USA Made).....	137
Motors .....	132-133
Relays.....	143
Square D® Electrical Disconnects.....	135
Stranded Copper THHN Wire .....	154-155
SwitchCap™ Dual.....	137
Terminals, Connectors.....	151
Thermal Controls .....	152
Thermostat Guards .....	153
Thermostat Wire .....	154
Thermostats .....	153
Time Delays .....	145
Transformers .....	154-155
Whips .....	134
Wire Connectors.....	155-156
Wire/Cable Ties, Mounts, Clamps .....	156-157



# A/C Disconnect Switches

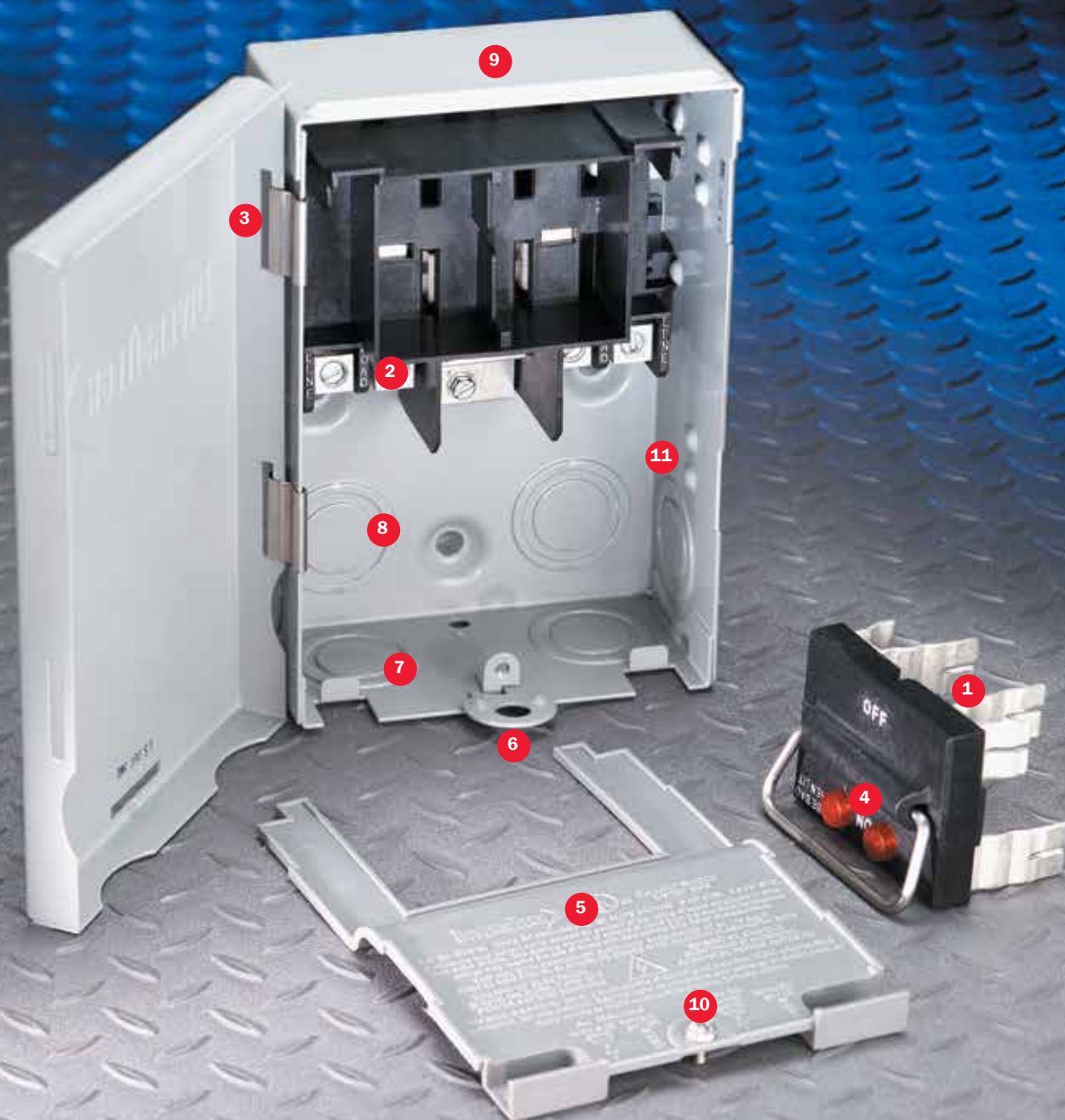

## A/C DISCONNECT FEATURES AND BENEFITS

- 1 Fuses install into pull-out handle
- 2 Line, load, and ground terminals aligned for easy hook up with heavy wires
- 3 Reversible side-opening door
- 4 Indicator lights for blown fuses
- 5 Full dead front
- 6 Folding pivot locking tab
- 7 Knockouts accommodate three sizes (1/2", 3/4", and 1")
- 8 Rear entry knockouts
- 9 Heavy gauge steel case
- 10 Standard 1/4" head screw on dead front
- 11 Large internal wiring space



### FUSES INSTALL INTO PULL-OUT HANDLE

The DiversiTech disconnect switch is available in two versions – fusible and non-fusible. On the fusible configuration, the pull-out handle also functions as a removable fuse holder. This feature permits easy removal and replacement of fuses. Rather than requiring a fuse puller to reach inside the disconnect switch and remove the blown fuses, one can easily change the fuses with the fuse holder removed from the disconnect switch.

### INDICATOR LIGHT FOR BLOWN FUSE

The fusible disconnect switch has an indicator light for fuse condition. When a fuse is blown, the red indicator light illuminates to show not only that a fuse is bad, but specifically, which fuse needs replacement. This feature provides rapid troubleshooting for the contractor inspecting an installation. One can tell instantly (visually) whether a fuse is bad.



### MOUNTING AND INLINE WIRING

A unique feature to the DiversiTech disconnect switch is the design of wiring terminals inline. This straight-line arrangement provides for quick and easy wire connection — no need to cut the connection wires to different lengths. All wires are easily installed without unnecessary bending or twisting.

### REVERSIBLE SIDE OPENING DOOR

The unique reversible side opening door provides for easy field change from left-hand hinge to right-hand hinge. The standard left-hand hinge is adequate for most all installations except for tight, inside, right-hand corners. In these instances, simply remove the two stainless steel hinge clips and move them to the right-hand side. This permits the door to hinge on the right.



# Fractional Horsepower Motors

## FEATURES AND BENEFITS



**COLOR PACKAGING**

Bright, colorful, easy to read packaging removes confusion about motors. The distributor can easily identify the stock of motors on the shelf. The application, voltage, and horsepower are visible at a glance.



**CAPACITOR SIZE**

The appropriate size 370 VAC run capacitor is noted on every motor carton.



**INNOVATIVE PACKAGING**

A unique styrofoam cradle inside the motor carton supports and protects the motor, shaft, and mounting bolts during shipment.

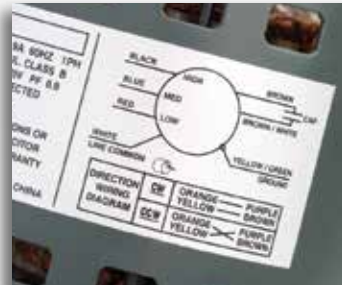

**LARGER DIAGRAM**

An extra large wiring diagram is supplied on the motor itself, on the motor carton, and also in the installation and safety instruction sheet. This large wiring diagram makes it very easy to read.

CROSS REFERENCE GUIDE	
WG840728	
208-230 VAC	1/4 hp
MARS	Q3728
PACKARD	63128
GEMLINE	EM3728
MARATHON	X213
AO SMITH	FSE1Q265
FASCO	D909

**CROSS REFERENCE**

For your convenience, Wagner provides a complete manufacturer cross-reference on the side of every motor carton.



**LARGE LABEL**

Informative product label contains the motor model number in large type. The UPC code is also printed on every motor label.



**CARTON HANDLE**

The motor carton has been designed with an innovative handle to make the motors much easier to carry.



**EXTENDED BOLTS**

Extended mounting bolts provide for easier installation in cramped spaces. With the longer bolts, the installer is able to more easily start the threaded mounting nut.



**EXTENDED WIRES**

Wagner motor wires are thirty inches long. The added length makes it easier for the contractor to install the new motor.



**STANDARD BALL BEARINGS**

Ball bearing design improves motor performance and reliability. It also increases heat endurance and motor life. Now standard on most models.



**WIRE STRIPPING**

Partial stripping leaves the insulation on the motor connection wire. This protects the stranded copper wire and prevents damage to individual strands.



**REVERSING PLUG**

The electrical reversing plug simplifies rotation direction changes.



**INSULATED DISCONNECTS**

Run capacitor connections are insulated for increased safety. Flag disconnects on condenser fan motors and inline disconnects on direct drive furnace blower motors are provided.

## MULTIPLE HORSEPOWER MOTORS

Multiple horsepower motors allow the contractor and distributor to consolidate multiple part codes into a single stocking unit. The multiple horsepower motor allows the contractor to carry one motor that can be used as a replacement for a wide variety of OEM and other replacement motors, saving time and money.



- *All the features and benefits of standard motors*
- *Plus multiple horsepower*
- *Variety of voltages, applications, and speeds are available.*

# Digital 3-Phase Line Voltage Monitor

The DTP-3 is an automatic digital voltage monitor and control system.

By continuously measuring the incoming line voltage, the DTP-3 monitor will detect voltages outside of the tolerance that you set.

If these limits are exceeded, the response timer is started. This timer may be set to a long time value to avoid nuisance tripping, or to a short time value to offer a higher level of load protection.

If the voltage remains outside of the selected tolerance after the time has elapsed, the DTP-3 will turn off its output relay and protect your device. While the load is off, an additional lockout timer is activated to avoid rapid restarts.

- Read Line and Load Side Voltage Instantly
- Simple Three Button Access for Easy Monitoring and Set-Up
- Fault Memory Records Problems for Later Display
- Six Digital Voltmeters Built In
- Sequential Start Timer Built In
- Lock Out Timer Built In
- Response Timer Built In

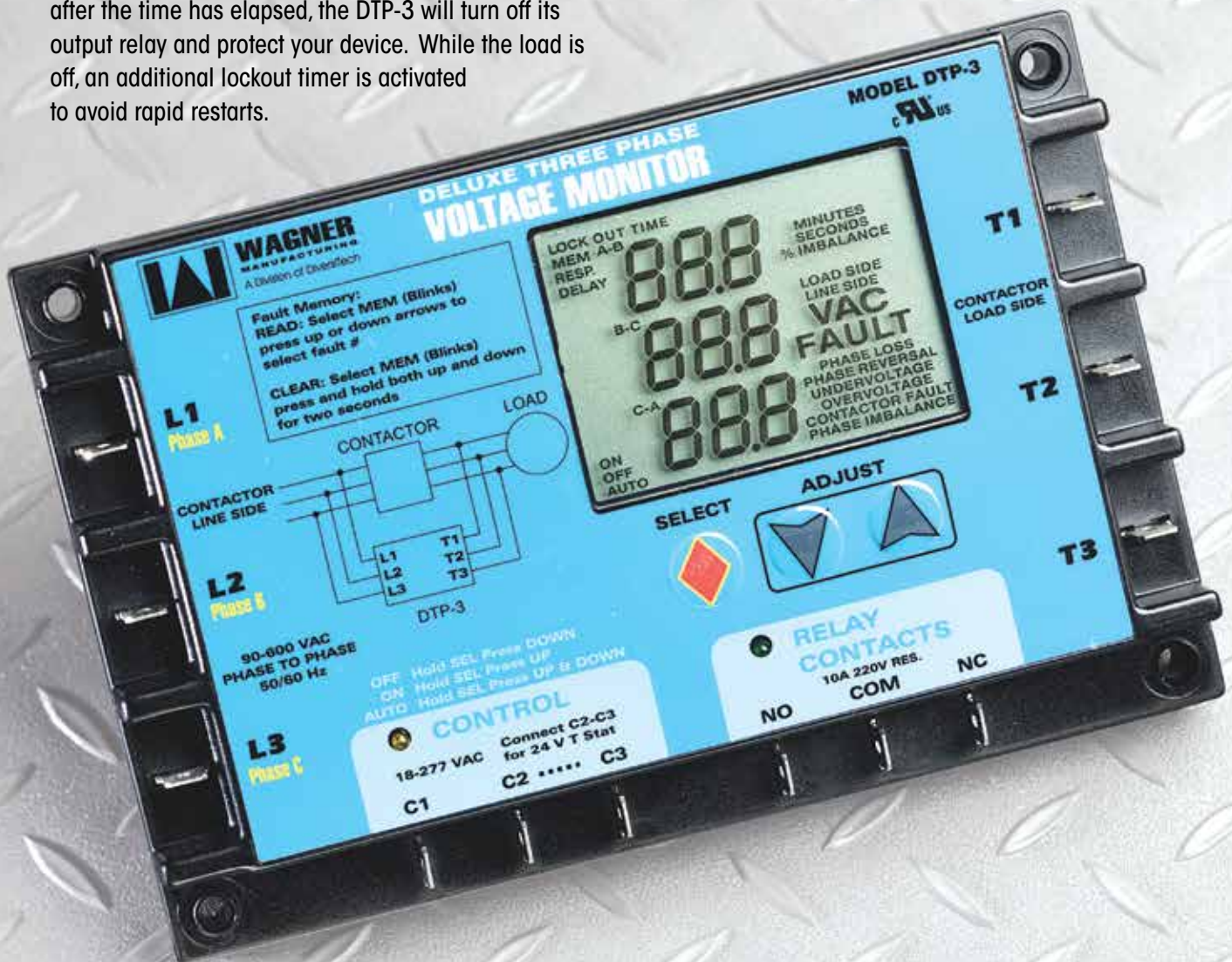



## FEATURES AND BENEFITS

### Large Digital LCD Display

Provides instant display of the system's operating voltage, not just indicator lights. System setup is simplified by using the display to set the exact voltage range you want to monitor. Other controls use dials for system adjustment that can lead to inaccurate settings and motor burnout.

### Super Simple Operation

Just three buttons set up everything. Easy adjustment of voltage tolerance and timers.

### Small Size

Small footprint and low profile fits where other can't.

### 10 Amp Rated Output Relay with Isolated Contacts

Powerful relay can connect to just about any control circuit. Normally-Open and Normally-Closed contacts are provided for connection to any type of system, motor control or alarm.

### 2 LED Indicators

Glowing light-emitting-diodes show applied control voltage and output relay operation at a glance.

### Precision Digital Circuitry

Completely eliminates the ambiguity associated with analog controls and screwdriver adjustments.

### Adjustable Response Time

This timer sets the amount of time between when a voltage outside of the selected tolerance is detected and when the output relay is de-energized. Setting low time values offers faster protection. Setting longer times provides greater resistance to nuisance tripping.

### Adjustable Delay Time

This timer sets the amount of time before the protected system is allowed to restart. Typically this timer is set to a value which allows the protected system to bleed-off high pressures or to cool down to a safe value for restarting.

### Broad Voltage Adjustment Range

User adjustable monitored voltage range from 160 to 650 VAC. This broad adjustment range incorporates voltages for the majority of compressor installation requirements. Therefore, this single unit can be used across a broad range of installations.

## DTP-3 FACTS

### Protection

Loss of Phase, Phase Reversal, Voltage Imbalance, Low Voltage, High Voltage.

### Display

Large custom LCD indicates all operating conditions at a glance. Three large sets of digits provide easy system troubleshooting.

### Voltmeter

Simultaneous display of all three line voltage pairs. One button switches to contactor load side voltage reading.

### Input Voltage Range

90 – 650 VAC at 50 or 60 hertz.

### Voltage Trip Point

Adjustable in 1 percent increments between 6% and 18% of the selected operating voltage. Restart voltage set point fixed at +3%.

### Voltage Symmetry

Adjustable imbalance set point from 2% to 25% of selected operating voltage.

### Lockout Delay Timer

Fully adjustable 0 to 720 seconds (0 to 12 minutes). Digital display shows remaining time and user set points.

### Sequential Start Timer

0 – 30 seconds in 1 second increments.

### Response Timer

0.1 to 20 seconds digital display shows remaining time and user set points.

### Memory

Up to 25 previous fault conditions are recorded for display as desired.

# Monitor Digital Trifasico de Linea de Voltaje

El DTP-3 es un monitor de voltaje y sistema de control automático digital.

Por estar midiendo continuamente la entrada de la línea de voltaje, este monitor detectará voltajes fuera de la tolerancia que se fijó.

Si este limite es excedido arrancará el Regulador de respuesta. Este regulador podrá ser fijado a una mayor escala de tiempo para evitar el ruido molesto del corte y arranque, o a una escala menor de tiempo para ofrecer un mayor nivel de protección de carga.

Si el voltaje permanece fuera de la tolerancia seleccionada después que el tiempo ha transcurrido, el DTP-3 apagará su relevador de rendimiento y protegerá su aparato. Mientras la carga esta apagada un regulador de cierre adicional es activado para evitar arranques inmediatos.

- Lectura de línea y de la carga de voltaje instantáneamente
- Tres simples botones de acceso para fácil monitoreo e instalación
- Registro de problemas en falla de memoria para posterior exhibición
- Seis volímetros digitales integrados
- Regulador de arranque secuencial integrado
- Regulador de cierre integrado
- Regulador de respuesta integrado



## DTP-3 CARACTERISTICAS Y BENEFICIOS

### La gran pantalla digital LCD

suministra al instante la operación del sistema de voltaje no solo luces indicadoras. El sistema programable es simplificado por usar la pantalla para fijar el rango exacto de voltaje que quiera monitorear. Otros controles usan botones para ajustar el sistema, que pueden dirigir hacia una programación inexacta y falla de motor.

### Operación super simple

solo tres botones operan todo. Fácil ajuste de tolerancia de voltaje y reguladores de tiempo.

### Pequeña medida

y su práctico contorno el cual se ajusta donde otros no pueden.

### Relevador de salida de 10 amps con contactos aislados

Relevador de poder que puede conectarse con cualquier circuito de control. Normalmente-Abierto y Normalmente-Cerrado contactos son suministrados para conectarse a cualquier tipo de sistema, control de motor o alarma.

### 2 indicadores LED

muestran el voltaje de control aplicado y la operación del relevador de salida en un solo vistazo.

### Los circuitos de precisión digital

eliminan completamente la ambigüedad asociada con controles análogos y ajustes de desarmador.

### Regulador de respuesta ajustable

Este regulador fija la cantidad de tiempo cuando un voltaje externo de la tolerancia seleccionada es detectado y cuando el relevador de salida es de-energizado. El fijar valores de tiempo bajos ofrece una más rápida protección. El fijar un tiempo prolongado suministra gran resistencia evitando el ruido molesto del corte y arranque.

### Regulador retardador de tiempo ajustable

Este regulador fija la cantidad de tiempo antes que al sistema de protección se le permita re-iniciar. Típicamente este regulador es fijado a un valor el cual permita al sistema de protección descargar altas presiones o que se enfríe a un valor seguro para re-iniciar.

### Amplio ajuste del rango de voltaje

El usuario monitorea el rango ajustable del voltaje de 160 a 650 VAC. Este amplio rango de ajuste incorpora voltajes para la mayoría de los requerimientos de instalación de compresores. Así mismo, esta unidad puede ser usada a través de un rango amplio de instalaciones.

## DTP-3 HECHOS

### Proteccion

Pérdida de fase, cambio de fase, desequilibrio de voltaje, bajo voltaje, alto voltaje.

### Pantalla

Los LCD hechos a la medida indican todas las condiciones de operación en un vistazo. Tres juegos grandes de dígitos suministran fácilmente los problemas del sistema.

### Voltimetro

Pantalla simultanea de las tres líneas pares de voltaje. Un botón cambia al contactor para la lectura de la carga de voltaje.

### Suministro de voltaje

90-650 VAC a 50 o 60 hertz.

### Margen de error del voltaje

Ajustable en un porcentaje de entre 6% y 18% de la operación del voltaje seleccionado. Re-inicio con un +3% del voltaje establecido.

### Simetria del voltaje

Desequilibrio ajustable establecido de 2% a 25% de la operación del voltaje seleccionado.

### Regulador retardador de cierre

Completamente ajustable de 0 a 720 segundos (0 a 12 minutos) la pantalla digital muestra el tiempo restante y los puntos establecidos por el usuario.

### Arrancador secuencial de tiempo

0 – 30 segundos en incrementos de 1 segundo.

### Regulador de respuesta

0.1 a 20 segundos la pantalla digital muestra el tiempo restante y los puntos establecidos por el usuario.

### Memoria

Hasta 25 condiciones de falla previas son almacenadas para mostrarse según se requiera.

# SwitchCap™ Dual Multiple Value Capacitor

*SwitchCap™ Dual Multiple Value Capacitor provides two, easily switchable, capacitors in one simple package. Using easy to set switches, rather than jumper wires, SwitchCap™ is the future of multiple value capacitors.*



### Integral Mounting Tabs

The simple, easy, and large mounting tabs allow for quick mounting with standard sheet metal screws. Other capacitors either have no obvious mounting method, or use a separate bracket. The integral mounting tabs provide a faster installation, saving the contractor time and money.



### Non-Conductive Polymer Enclosure

Inside a condensing unit, there are electrical terminals everywhere. It is much safer to install a capacitor with a non-conductive polymer enclosure. Metal enclosures also corrode easily over time, resulting in the potential for capacitor failure and call backs. SwitchCap™ Dual uses a non-conductive polymer enclosure resulting in a longer life capacitor.



### No Jumper Wires Needed

Complicated jumper wires on competing products mean you aren't exactly sure what capacitor value you are connecting. It's not easy to understand. With DiversiTech's SwitchCap™ Dual Multiple Value Capacitor, just set the switches for the cap value you need. Connect to the standard Herm, Run, Common terminal connections. Don't get confused with 7 different terminals from other multiple value capacitors.



### Protective Cover

SwitchCap™ Dual also comes with a hard protective cover which fits over the bottom adjustable switches to prevent them from accidental movement.





### Better Heat Sink

Heat generated by electricity is a significant contributor to capacitor failure. All capacitors use some type of heat sink to exhaust heat to the atmosphere. Conventional capacitors use a mineral oil fill, SwitchCap™ Dual uses an epoxy fill. Epoxy 0.20 Btu/(ft.hr.F) is nearly 2X as conductive to heat as mineral oil 0.09 Btu/(ft.hr.F). Epoxy gets rid of the heat faster than oil, resulting in a longer life capacitor.



### Dual Capacitance

Just like a standard dual value capacitor, there are two capacitors in the same can. One for the herm side, one for the fan.



### Fire Resistant Heat Sink

The innovative heat sink material used in SwitchCap™ Dual is certified by UL to be fire resistant. Competing products using oil filled capacitors are not fire resistant.



### UL 508 Recognized

DiversiTech's SwitchCap™ Dual Multiple Value Capacitor has been tested by ETL and meets all requirements of the UL508 standard.



### Heavy Duty

SwitchCap™ Dual is a heavy duty, heavy weight capacitor. Weight in a capacitor indicates the amount of heat sink material inside. More heat sink material, more weight. A heavier capacitor will typically last longer, and result in fewer call backs than a lighter weight capacitor.

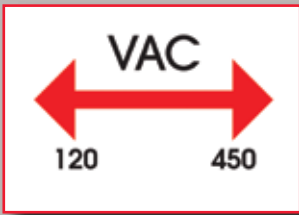

### Multiple Operating Voltages

The same capacitor is used for 120 to 450VAC applications. One part number for all values significantly reduces on truck and warehouse inventory. This results in fewer components to stock.



### Wide Capacitance Range

DiversiTech's SwitchCap™ Dual Multiple Value Capacitor features an extremely wide capacitance range. For the Herm side, values from 15 to 60 micro-Farads are available. For the Fan side 3 to 10.5 microFarads are your selections. Combined, the total capacitance value is 70.5 microFarads.



### Oil Free

Oil has been around for millions of years, and the use of oil as an insulator in a capacitor almost as long. Oil is an old technology. It is messy, and not environmentally friendly. Modern capacitors like DiversiTech's SwitchCap™ Dual Multiple Value Capacitor use an epoxy fill to hermetically seal out any moisture — the leading cause of capacitor failure.



### Wide Ambient Temperature Range

DiversiTech's SwitchCap™ Dual Multiple Value Capacitor can be installed in an extremely wide ambient temperature range from -40C to 70C (-40F to 158F).

**MOTORS**

**Condenser Fan Motors, Single Speed**

- Installs with all Standard 48 Frame Mounting Brackets
- Standard Shaft Length, Diameter, and Flats
- Drain Holes with Plugs in both end plates
- Automatic Thermal Overload Protector
- Standard 48 Frame Motor Casing Size
- Low Power Consumption
- 60 C Ambient Design
- Electrically Reversible
- Continuous Air Over
- Class B Insulation
- Quiet Operation
- Extended Studs
- 30" Leads
- 60 HZ



**BALL BEARINGS NOW STANDARD**



CATALOG NO.	HP	VOLTAGE	SPEED	FLA	UOM	ORDER MULTIPLE
WG840727	1/6	208-230	1075/1	1.3	EA	1
WG840728	1/4	208-230	1075/1	2.2	EA	1
WG840729	1/3	208-230	1075/1	2.8	EA	1
WG840730	1/2	208-230	1075/1	4.2	EA	1
WG840731	3/4	208-230	1075/1	4.5	EA	1
WG840204	1/4	208-230	825/1	1.5	EA	1
WG840205	1/3	208-230	825/1	2.2	EA	1

**Direct Drive Furnace Blower Motors**

- Installs with all Standard 48 Frame Mounting Brackets
- Standard Shaft Length, Diameter, and Flats
- Uses 370V Capacitors
- Standard 48 Frame Motor Casing Size
- 2.5" Diameter Hub Rings included
- Low Power Consumption
- Automatic Thermal Overload Protector
- Continuous Duty, Air Over
- Electrically Reversible
- Class B Insulation
- Speed: 1075/3
- Quiet Operation
- 60 HZ



**BALL BEARINGS NOW STANDARD**

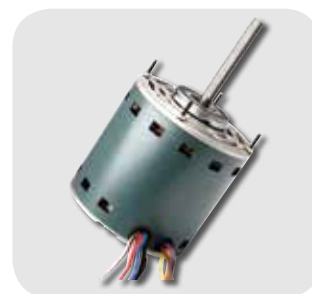

CATALOG NO.	HP	VOLTAGE	SPEED	FLA	UOM	ORDER MULTIPLE
WG840583	1/4	115	1075/3	4.6	EA	1
WG840584	1/4	208-230	1075/3	2.2	EA	1
WG840585	1/3	115	1075/3	6.7	EA	1
WG840586	1/3	208-230	1075/3	2.9	EA	1
WG840587	1/2	115	1075/3	10.2	EA	1
WG840588	1/2	208-230	1075/3	5.0	EA	1
WG840589	3/4	115	1075/3	11.3	EA	1
WG840590	3/4	208-230	1075/3	5.4	EA	1
WG840595	1	115	1075/3	12.6	EA	1
WG840596	1	208-230	1075/3	5.59	EA	1

**High Temperature Condenser Fan Motors**

- 70°C Ambient Temperature
- Installs with all Standard 48 Frame Mounting Brackets
- Standard Shaft Length, Diameter, and Flats
- Drain Holes with Plugs in both end plates
- Automatic Thermal Overload Protector
- Standard 48 Frame Motor Casing Size
- Low Power Consumption
- Electrically Reversible
- Continuous Air Over
- Class B Insulation
- Quiet Operation
- Extended Studs
- 30" Leads
- 60 HZ



**BALL BEARINGS NOW STANDARD**



CATALOG NO.	HP	VOLTAGE	SPEED	FLA	UOM	ORDER MULTIPLE
WG840728HT	1/4	208-230	1075/1	2.2	EA	1
WG840729HT	1/3	208-230	1075/1	2.8	EA	1
WG840730HT	1/2	208-230	1075/1	4.2	EA	1
WG840731HT	3/4	208-230	1075/1	5.3	EA	1
WG840736HT	1/4	460	1075/1	1.65	EA	1
WG840737HT	1/3	460	1075/1	2.85	EA	1
WG840738HT	1/2	460	1075/1	4.3	EA	1
WG840739HT	3/4	460	1075/1	5.3	EA	1
WG840204HT	1/4	208-230	825/1	1.5	EA	1
WG840205HT	1/3	208-230	825/1	2.2	EA	1

## MOTORS cont'd

The Multi-Horsepower motors are specially designed to cover a range of applications. The condenser fan motors range from 1/2 to 1/5; 1/3 to 1/6 both at 1075 rpm; 1/3 to 1/6 at 825rpm. The direct drive furnace blower motors range from 1/2 to 1/6 in both 115 and 230 volts and 3/4 to 1/5 in both 115 and 230 volts all at 1075rpm. These motors feature reversing plugs, extended thru bolts 36 inch leads and are designed for 370 volt capacitors. Installs with all 48 frame mounting brackets.

### Multiple Horsepower Motors

CATALOG NO.	APPLICATION	VOLTAGE	SPEED	(1) HP-FLA	(2) HP-FLA	(3) HP-FLA	(4) HP-FLA	(5) HP-FLA	UOM	ORDER MULTIPLE
WG840463	DDFB	115	1075/4	1/2-7.0	1/3-6.7	1/4-4.4	1/5-3.2	1/6-2.4	EA	1
WG840464	DDFB	208-230	1075/4	1/2-3.9	1/3-3.6	1/4-2.5	1/5-1.8	1/6-1.3	EA	1
WG840466	DDFB	115	1075/4	3/4-8.1	1/2-6.6	1/3-4.6	1/4-3.8	1/5-3.1	EA	1
WG840467	DDFB	208-230	1075/4	3/4-3.8	1/2-3.7	1/3-2.5	1/4-1.8	1/5-1.7	EA	1



### Multiple Horsepower Condenser Fan Motors

CATALOG NO.	APPLICATION	VOLTAGE	SPEED	(1) HP-FLA	(2) HP-FLA	(3) HP-FLA	(4) HP-FLA	(5) HP-FLA	UOM	ORDER MULTIPLE
WG840465	CF	208-230	1075/2	1/3-2.8	1/4-2.0	1/5-1.7	1/6-1.5		EA	1
WG840468	CF	208-230	1075/2	1/2-3.0	1/3-2.5	1/4-2.0	1/5-1.3		EA	1
WG840469	CF	208-230	825/2	1/3-2.1	1/4-1.7	1/5-1.5	1/6-1.2		EA	1

## MOTOR BRACKETS

### DiversiTech Motors Bracket

These brackets help hold the motor securely.



CATALOG NO.	DESCRIPTION	UOM	ORDER MULTIPLE
DMB-1	Fixed Lug Assembly for 5-1/2" diameter motors	EA	1
DMB-2	Adjustable Lug Assembly for 5-1/2" diameter motors	EA	1

### Motor Mount – Flex Bracket

Torsion Flex Bracket holds motor securely. Fits 5- 1/2" motors. Typically used for Goodman equipment.



CATALOG NO.	DESCRIPTION	UOM	ORDER MULTIPLE
DMB-3	5-1/2" Motor Mount Torsion Flex Bracket	EA	1

### Rheem Motor Bracket

These brackets help hold the motor securely.



CATALOG NO.	DESCRIPTION	UOM	ORDER MULTIPLE
A60306K	Mounting Plate for Rheem Condensing UnitsEA		1

## BEARINGS

### Cushioned Pillow Blocks

These blocks are used to reduce noise from vibration from motors.

CATALOG NO.	DESCRIPTION	INDUSTRY NO.	LAU NO.	BEARING SHAFT SIZE	UOM	ORDER MULTIPLE
535-BB1	Bronze Bearing Pillow Block	NAH8A		1/2"	EA	1
535-BB2	Bronze Bearing Pillow Block	NAH10A	38-2204-01	5/8"	EA	1
535-BB3	Bronze Bearing Pillow Block	NAH12A	38-2086-01	3/4"	EA	1
535-BB4	Bronze Bearing Pillow Block	NAH16A	38-2087-01	1"	EA	1



### Side Flange Mount Pillow Blocks

These blocks are used to reduce noise from vibration from motors.

CATALOG NO.	DESCRIPTION	INDUSTRY NO.	BEARING SHAFT SIZE	UOM	ORDER MULTIPLE
535-BB5	Cushioned Flange Block	NVH12A	3/4"	EA	1
535-BB6	Cushioned Flange Block	NVH10A	5/8"	EA	1



**WHIPS**

**DiversiWhips**

Liquid tight flexible conduit system. A labor saving convenience kit for A/C unit hookup. Also use for heat pumps, refrigeration, hot tubs, swimming pools and outdoor lighting. Three distinct wire colors for ease of hookup. 1 straight and 1 90 degree metallic or non metallic connector. 90 degree connector is removable for straight connections. (Second straight connector not included.) U.L. and C.U.L Listed.



CATALOG NO.	DESCRIPTION	UOM	ORDER MULTIPLE
6-12-4	1/2 x 4' #10 THHN Wire – Metallic Connectors	EA	6
6-12-6	1/2 x 6' #10 THHN Wire – Metallic Connectors	EA	6
6-34-4	3/4 x 4' #8 THHN Wire – Metallic Connectors	EA	6
6-34-6	3/4 x 6' #8 THHN Wire – Metallic Connectors	EA	6
6-34-8	3/4 x 8' #8 THHN Wire – Metallic Connectors	EA	3
6-12-4NM	1/2 x 4' #10 THHN Wire – Non-Metallic Connectors	EA	6
6-12-6NM	1/2 x 6' #10 THHN Wire – Non-Metallic Connectors	EA	6
6-34-3NM	3/4 x 3' #8 THHN Wire – Non-Metallic Connectors	EA	6
6-34-4NM	3/4 x 4' #8 THHN Wire – Non-Metallic Connectors	EA	6
6-34-6NM	3/4 x 6' #8 THHN Wire – Non-Metallic Connectors	EA	6
6-34-8NM	3/4 x 8' #8 THHN Wire – Non-Metallic Connectors	EA	3
6-12-6NMSP8	1/2 x 6' #10 Wire – Single Piece – Non-Metallic Connectors	EA	6

\*For DiversiWhips produced with 2 straight connectors, add S to part number (ex: 6-12-4S).

**DiversiWhips for the Swimming Pool Industry**

A labor saving kit for hookup of swimming pool motors, pumps, filters, and timers. Three distinct wire colors for ease of hookup. 1 straight and 1 90 degree metallic or non metallic connector included.



CATALOG NO.	DESCRIPTION	UOM	ORDER MULTIPLE
6-12-4P	1/2 x 4' #12 THHN Wire – Metallic Connectors	EA	6
6-12-6P	1/2 x 6' #12 THHN Wire – Metallic Connectors	EA	6
6-12-8P	1/2 x 8' #12 THHN Wire – Metallic Connectors	EA	6
6-12-4NMP	1/2 x 4' #12 THHN Wire – Non-Metallic Connectors	EA	6
6-12-6NMP	1/2 x 6' #12 THHN Wire – Non-Metallic Connectors	EA	6
6-12-8NMP	1/2 x 8' #12 THHN Wire – Non-Metallic Connectors	EA	6

**Solid Wire Whips**

6-12-4NMSWP	1/2 x 4' #12 Solid 3 Wire – Non-Metallic Connectors	EA	6
6-12-6NMSWP	1/2 x 6' #12 Solid 3 Wire – Non-Metallic Connectors	EA	6
6-12-8NMSWP	1/2 x 8' #12 Solid 3 Wire – Non-Metallic Connectors	EA	3
6-12-4NM4SWP	1/2 x 4' #12 Solid 4 Wire – Non-Metallic Connectors	EA	6
6-12-6NM4SWP	1/2 x 6' #12 Solid 4 Wire – Non-Metallic Connectors	EA	6
6-12-8NM4SWP	1/2 x 8' #12 Solid 4 Wire – Non-Metallic Connectors	EA	3

**DiversiWhips Pallet Packs**

DiversiWhips are now available in a convenient, bulk packaged pallet pack at a discounted price. Pallet pack makes an attractive floor standing display. 1 straight and 1 90 degrees metallic or non metallic connector.



CATALOG NO.	DESCRIPTION	UOM	ORDER MULTIPLE
B6-12-4	1/2 x 4' #10 THHN Wire – Metallic Connectors	EA	90
B6-12-6	1/2 x 6' #10 THHN Wire – Metallic Connectors	EA	60
B6-34-4	3/4 x 4' #8 THHN Wire – Metallic Connectors	EA	60
B6-34-6	3/4 x 6' #8 THHN Wire – Metallic Connectors	EA	45
B6-12-4NM	1/2 x 4' #10 THHN Wire – Non-Metallic Connectors	EA	90
B6-12-6NM	1/2 x 6' #10 THHN Wire – Non-Metallic Connectors	EA	60
B6-34-4NM	3/4 x 4' #8 THHN Wire – Non-Metallic Connectors	EA	60
B6-34-6NM	3/4 x 6' #8 THHN Wire – Non-Metallic Connectors	EA	45

**DiversiWhips with Extended Length Wires**

DiversiWhips are available with extra long lead wires for those difficult to wire applications. These whips offer 10in. of lead wire on the straight side and 18in. of lead wire on the 90 degree side.



CATALOG NO.	DESCRIPTION	UOM	ORDER MULTIPLE
6-12-4R	1/2 x 4' #10 THHN Wire – Metallic Connectors	EA	6
6-12-6R	1/2 x 6' #10 THHN Wire – Metallic Connectors	EA	6
6-34-4R	3/4 x 4' #8 THHN Wire – Metallic Connectors	EA	6
6-34-6R	3/4 x 6' #8 THHN Wire – Metallic Connectors	EA	6
6-12-4NMR	1/2 x 4' #10 THHN Wire – Non-Metallic Connectors	EA	6
6-12-6NMR	1/2 x 6' #10 THHN Wire – Non-Metallic Connectors	EA	6
6-34-4NMR	3/4 x 4' #8 THHN Wire – Non-Metallic Connectors	EA	6
6-34-6NMR	3/4 x 6' #8 THHN Wire – Non-Metallic Connectors	EA	6



**DIVERSITECH ELECTRICAL DISCONNECTS**

**Disconnects—Metal Case**

Fused model designed with fuses in pull out handle for easy replacement. The line, load, and ground terminals are aligned for ease of wiring. This product has a reversible door which opens to either the left or right. The side open door opens more than 180 degrees for maximum access and has a full dead front. The fused models have indicator lights for blown fuses. This is rain tight and sleet resistant. The UL Listed number is IRF9, NEMA Type 3R and the US Patent is 6,630,637.



DDS-60

CATALOG NO.	DESCRIPTION	UOM	ORDER MULTIPLE
DDS-30	30A Fusible Disconnect Switch	EA	10
DDS-60	60A Fusible Disconnect Switch	EA	10
DDS-60U	60A Non-Fusible Disconnect Switch	EA	10

**Low Profile Disconnects—Metal Case**

This low profile disconnect switch is a slightly smaller design than that of the standard DiversiTech disconnects. This has a side opening door with a full dead front. This is rain tight and sleet resistant. The UL Listed number is IRF9, NEMA Type 3R.



EDS-60U

CATALOG NO.	DESCRIPTION	UOM	ORDER MULTIPLE
EDS-60U	60A Non-Fusible Disconnect Switch	EA	10

**Disconnects—Non Metallic Case**

All the features of standard DiversiTech electrical disconnects, but in a non metallic case that will not corrode.



750-P60NF

CATALOG NO.	DESCRIPTION	UOM	ORDER MULTIPLE
750-P60NF	60A Non Fusible Disconnect Switch, Non Metallic Case, Plastic	EA	10

**SQUARE D ELECTRICAL DISCONNECTS**

**Square D - Q0200TR A/C Disconnect**

This A/C Disconnect is 60 amp switch rated for 10 HP motors at 240 VAC. The switch is an on off circuit breaker with no pull out head that could be lost or stolen. There are four one inch combination locks with two being in the back and two in the bottom end wall. Removing the cover housing on this disconnect provides open to lugs for easy wiring.



Q0200TR



CATALOG NO.	DESCRIPTION	UOM	ORDER MULTIPLE
Q0200TR	60A Disconnect Switch	EA	1

**Three Phase Disconnects**

UL listed, File E5239. Meets UL98 for enclosed switches and NEMA Std. KS 1. Suitable as service entrance equipment when applied with neutral or ground lug kit. Rainproof type 3R enclosure.



750-30F-3PH



CATALOG NO.	DESCRIPTION	UOM	ORDER MULTIPLE
750-30F-3PH	Fusible 30 Amp	EA	1
750-60F-3PH	Fusible 60 Amp	EA	1
750-60NF-3PH	Non-Fusible 60 Amp	EA	1

**CONDUIT, FITTINGS, CABLE**

**Liquid Tite Flexible Conduit**

For electrical applications: outside, inside and industrial uses including transformer connections, air conditioning and heating. Joins with metallic or non-metallic connectors, easy to cut. Impact resistant, chemical resistant, and will not kink. U.L. and C.U.L. Listed. For use as indicated in Article 351 of the 1987 NEC.



750-12100

CATALOG NO.	DESCRIPTION	UOM	ORDER MULTIPLE
750-12100	1/2" x 100' Liquid Tite Conduit – Non-Metallic, 100' per roll	EA	1
750-12100BOX	1/2" x 100' Liquid Tite Conduit – Non-Metallic (in box), 100' per roll	EA	1
750-34100	3/4" x 100' Liquid Tite Conduit – Non-Metallic, 100' per roll	EA	1
750-10100	1" x 100' Liquid Tite Conduit – Non-Metallic, 100' per roll	EA	1
750-500	1/2" x 100' Liquid Tite Conduit – Metallic, 100' per roll	EA	1
750-600	3/4" x 100' Liquid Tite Conduit – Metallic, 100' per roll	EA	1

**Aluminum Armored MC Cable**

90°C Rated aluminum metal clad cable system. THHN solid copper with specially compounded heat-resistant U.L. Listed insulation and jacket. Flexible interlocked aluminum armor. Extremely durable – withstands severe handling. U.L. Listed #4. Conforms to NEC article 333.



640-122

CATALOG NO.	DESCRIPTION	UOM	ORDER MULTIPLE
640-122	12-2 Aluminum Armored MC Cable – 100' per roll	EA	1
640-142	14-2 Aluminum Armored MC Cable – 100' per roll	EA	1

**CONDUIT, FITTINGS, CABLE cont'd**

**Romex Connectors – Metallic**

These Metallic Romex Connectors are made of zinc die cast are cable connectors for Romex wire. U.L. Listed C.S.A. Approved.



CATALOG NO.	DESCRIPTION	UOM	ORDER MULTIPLE
750-RC841	3/8" Romex Connector for 1/2" Knockouts	EA	100
750-RC842	3/4" Romex Connector for 3/4" Knockouts	EA	50

U.L. Listed and C.S.A. Approved.

**EMT (Thinwall) Fittings**

These are used to join EMT conduit to boxes on enclosures.



CATALOG NO.	DESCRIPTION	UOM	ORDER MULTIPLE
625-800	Set Screw Connector – 1/2"	EA	50
625-801	Set Screw Connector – 3/4"	EA	25
625-304	Strap – One Hole – 1/2"	EA	100
625-305	Strap – One Hole – 3/4"	EA	100
625-810	Set Screw Coupling – 1/2"	EA	50
625-811	Set Screw Coupling – 3/4"	EA	25

**Non-Metallic Sheathed Cable (Romex Wire)**

600V building wire. Easy to pull and strip, flame and moisture resistant. Saves time, labor and money. Color coded conductors of copper, PVC insulation and outer jacket with ground. U.L. Listed 719 Federal Specifications J C94.



CATALOG NO.	DESCRIPTION	UOM	ORDER MULTIPLE
620-6-2	6 AWG, 2 Conductors with Ground – 125' per pack	EA	1
620-8-2	8 AWG, 2 Conductors with Ground – 125' per pack	EA	1
620-10-2	10 AWG, 2 Conductors with Ground – 250' per pack	EA	1
620-12-2	12 AWG, 2 Conductors with Ground – 250' per pack	EA	1
620-14-2	14 AWG, 2 Conductors with Ground – 250' per pack	EA	1

U.L. Listed 719 Federal Specifications J-C94.

**Cable Staples**

Cable Staples for NMB Cable (Romex) and Copper Insulated Staples for thermostat wire.



CATALOG NO.	DESCRIPTION	UOM	ORDER MULTIPLE
625-183	Romex Staples – 1/2", pack of 100	PK	1
625-IS5	Copper Insulated #5 Staples for T-Stat Wire	EA	100

**Liquid Tite Connectors**

For use with metallic and non metallic liquid tite conduit, Type B. Provides smooth connection, no sharp edges to strip wire. Wiring easily pulled through. U. L. Listed. C.U.L. Listed.



CATALOG NO.	DESCRIPTION	UOM	ORDER MULTIPLE
750-NMLT50	1/2" Non-Metallic Straight Connector	EA	25
750-NMLT4550	1/2" Non-Metallic 45 Degree Elbow Connector	EA	10
750-NMLT9050	1/2" Non-Metallic 90 Degree Elbow Connector	EA	10
750-NMLT75	3/4" Non-Metallic Straight Connector	EA	10
750-NMLT4575	3/4" Non-Metallic 45 Degree Elbow Connector	EA	10
750-NMLT9075	3/4" Non-Metallic 90 Degree Elbow Connector	EA	10
750-NMLT100	1" Non-Metallic Straight Connector	EA	5
750-NMLT90100	1" Non-Metallic 90 Degree Elbow	EA	5
750-NMLT150	1-1/2" Non-Metallic Straight Connector	EA	5
750-NMLT90150	1-1/2" Non-Metallic 90 Degree Elbow	EA	5
750-NMLT200	2" Non-Metallic Straight Connector	EA	5
750-NMLT90200	2" Non-Metallic 90 Degree Elbow	EA	5
750-MLT50	1/2" Metallic Straight Connector	EA	25
750-MLT9050	1/2" Metallic 90 Degree Elbow	EA	10
750-MLT75	3/4" Metallic Straight Connector	EA	10
750-MLT9075	3/4" Metallic 90 Degree Elbow	EA	10

**BX Set Screw Connectors**

These connectors are for BX cable range of .445 to .630 in diameter. This product is UL listed and CSA approved.



CATALOG NO.	DESCRIPTION	UOM	ORDER MULTIPLE
640-845	Trade Size – 3/8"	EA	100

**Single Piece Liquid Tite Fittings**

Conduit threads onto ferrule and up inside the outer body. An inside taper squeezes down on the outside of conduit for a superior liquid tight seal. The cut portion of the conduit does not show, giving a more finished appearance. Easy to use at a lower cost than regular liquid tite fittings.



CATALOG NO.	DESCRIPTION	UOM	ORDER MULTIPLE
750-SLTC50	1/2" Straight Screw-On Fitting	EA	25
750-SLTC9050	1/2" 90° Screw-On Fitting	EA	25
750-SLTC75	3/4" Straight Screw-On Fitting	EA	25
750-SLTC9075	3/4" 90° Screw-On Fitting	EA	25

**SWITCHCAP DUAL**

**SwitchCap™ Dual  
Multiple Value Capacitor**

The SwitchCap™ Dual from DiversiTech is a multi-value capacitor that replaces hundreds of single setting capacitors. SwitchCap™ offers excellent reliability in an epoxy-filled motor run capacitor. SwitchCap™ can be easily configured to any setting using the adjustable rocker switches on the bottom. SwitchCap™ simplifies the way you work by eliminating the need for almost all of the typical motor-run capacitor inventory. It's a must have for any technician.



CATALOG NO.	DESCRIPTION	UOM	ORDER MULTIPLE
<b>SCAP-60D</b>	SwitchCap™ Dual Multiple Value Capacitor	EA	6

**MOTOR RUN CAPACITORS (USA MADE)**

**Made in the U.S.A. Capacitors  
Round Metal Can**

Line of made in the USA capacitors featuring dual voltage for both 370V and 440V applications. Designed specifically for the demands of aftermarket service parts.



CATALOG NO.	VOLTAGE	uf	UOM	ORDER MULTIPLE
<b>4JR0525U</b>	370V/440V	25+5	EA	1
<b>4JR0530U</b>	370V/440V	30+5	EA	1
<b>4JR0535U</b>	370V/440V	35+5	EA	1
<b>4JR0540U</b>	370V/440V	40+5	EA	1
<b>4JR7540U</b>	370V/440V	40+7.5	EA	1
<b>4JR0545U</b>	370V/440V	45+5	EA	1
<b>4JR7545U</b>	370V/440V	45+7.5	EA	1
<b>4JR0550U</b>	370V/440V	50+5	EA	1
<b>4JR0555U</b>	370V/440V	55+5	EA	1
<b>4JR0560U</b>	370V/440V	60+5	EA	1

**Made in the U.S.A. Capacitors  
Oval Metal Can**

Line of made in the USA capacitors featuring dual voltage for both 370V and 440V applications. Designed specifically for the demands of aftermarket service parts.



CATALOG NO.	VOLTAGE	uf	UOM	ORDER MULTIPLE
<b>45050HU</b>	370V/440V	5	EA	1
<b>45075HU</b>	370V/440V	7.5	EA	1
<b>45100HU</b>	370V/440V	10	EA	1
<b>45150HU</b>	370V/440V	15	EA	1
<b>45200HU</b>	370V/440V	20	EA	1
<b>45250HU</b>	370V/440V	25	EA	1
<b>45300HU</b>	370V/440V	30	EA	1
<b>45350HU</b>	370V/440V	35	EA	1
<b>45400HU</b>	370V/440V	40	EA	1
<b>45450HU</b>	370V/440V	45	EA	1
<b>45125HU</b>	370V/440V	12.5	EA	1
<b>45500HU</b>	370V/440V	50	EA	1

**CAPACITORS**

**Motor Run Capacitors—370VAC, Metal, Oval Can**

These single capacitance oval, metal can capacitors are designed for continuous run.



CATALOG NO.	uf	UOM	ORDER MULTIPLE
37020H	2	EA	1
37030H	3	EA	1
37040H	4	EA	1
37050H	5	EA	1
37050HB	5	EA	100*
37060H	6	EA	1
37075H	7.5	EA	1
37075HB	7.5	EA	100*
37100H	10	EA	1
37100HB	10	EA	100*
37125H	12.5	EA	1
37150H	15	EA	1
37175H	17.5	EA	1
37200H	20	EA	1
37250H	25	EA	1
37300H	30	EA	1
37350H	35	EA	1
37400H	40	EA	1
37450H	45	EA	1
37500H	50	EA	1
37600H	60	EA	1
37700H	70	EA	1
37800H	80	EA	1

\*100 per pack

**Motor Run Capacitors—370VAC**

This single capacitance round, metal can capacitors are designed for continuous run.



CATALOG NO.	uf	UOM	ORDER MULTIPLE
37050R	5	EA	1
37075R	7.5	EA	1
37100R	10	EA	1
37125R	12.5	EA	1
37150R	15	EA	1
37175R	17.5	EA	1
37200R	20	EA	1
37250R	25	EA	1
37300R	30	EA	1
37350R	35	EA	1
37400R	40	EA	1
37450R	45	EA	1
37500R	50	EA	1
37550R	55	EA	1
37600R	60	EA	1
37800R	80	EA	1

**Motor Run Capacitors—370VAC**

Dual capacitance. Oval, metal can.



CATALOG NO.	uf	UOM	ORDER MULTIPLE
3GJ0515	15+5	EA	1
3GJ1015	15+10	EA	1
3GJ0520	20+5	EA	1
3GJ1520	20+15	EA	1
3GJ0525	25+5	EA	1
3GJ1025	25+10	EA	1
3GJ0330	30+3	EA	1
3GJ0530	30+5	EA	1
3GJ7530	30+7.5	EA	1
3GJ0535	35+5	EA	1
3GJ7535	35+7.5	EA	1
3GJ7545	45+7.5	EA	1
3GJ0540	40+5	EA	1
3GJ0545	45+5	EA	1
3GJ0555	55+5	EA	1
3GJ7555	55+7.5	EA	1
3GJ1060	60+10	EA	1

**Motor Run Capacitors—370VAC**

This dual capacitance round metal can capacitors are designed for continuous run.



CATALOG NO.	uf	UOM	ORDER MULTIPLE
3GR0325	25+3	EA	1
3GR0330	30+3	EA	1
3GR0335	35+3	EA	1
3GR0340	40+3	EA	1
3GR0425	25+4	EA	1
3GR0525	25+5	EA	1
3GR0530	30+5	EA	1
3GR7530	30+7.5	EA	1
3GR0435	35+4	EA	1
3GR0515	15+5	EA	1
3GR0520	20+5	EA	1
3GR0535	35+5	EA	1
3GR0540	40+5	EA	1
3GR0545	45+5	EA	1
3GR0550	50+5	EA	1
3GR0555	55+5	EA	1
3GR0560	60+5	EA	1
3GR0570	70+5	EA	1
3GR0580	80+5	EA	1
3GR1080	80+10	EA	1
3GR7540	40+7.5	EA	1
3GR7555	55+7.5	EA	1
3GR7560	60+7.5	EA	1
3GR7580	80+7.5	EA	1
3GR1035	35+10	EA	1

**Motor Run Capacitors—440VAC**

These single capacitance oval, metal can capacitors are designed for continuous run.



CATALOG NO.	uf	UOM	ORDER MULTIPLE
45020H	2	EA	1
45030H	3	EA	1
45040H	4	EA	1
45050H	5	EA	1
45060H	6	EA	1
45075H	7.5	EA	1
45100H	10	EA	1
45125H	12.5	EA	1
45150H	15	EA	1
45175H	17.5	EA	1
45200H	20	EA	1
45250H	25	EA	1
45300H	30	EA	1
45350H	35	EA	1
45400H	40	EA	1
45450H	45	EA	1
45500H	50	EA	1
45550H	55	EA	1
45600H	60	EA	1
45700H	70	EA	1
45800H	80	EA	1

**Motor Run Capacitor—440VAC**

Single capacitance. Round, metal can.



CATALOG NO.	uf	UOM	ORDER MULTIPLE
45150R	15	EA	1
45175R	17.5	EA	1
45200R	20	EA	1
45250R	25	EA	1
45300R	30	EA	1
45350R	35	EA	1
45400R	40	EA	1
45450R	45	EA	1
45500R	50	EA	1
45550R	55	EA	1
45600R	60	EA	1
45700R	70	EA	1
45800R	80	EA	1

**Motor Run Capacitor—440VAC**

Dual capacitance. Oval, metal can.



CATALOG NO.	uf	UOM	ORDER MULTIPLE
4JJ0525	25+5	EA	1
4JJ0530	30+5	EA	1
4JJ0535	35+5	EA	1
4JJ0540	40+5	EA	1
4JJ0545	45+5	EA	1
4JJ0555	55+5	EA	1
4JJ7535	35+7.5	EA	1
4JJ7540	40+7.5	EA	1
4JJ7545	45+7.5	EA	1
4JJ1055	55+10	EA	1
4JJ0560	60+5	EA	1

**Motor Run Capacitor—440VAC**

Dual capacitance. Round, metal can.



CATALOG NO.	uf	UOM	ORDER MULTIPLE
4JR0520	20+5	EA	1
4JR0525	25+5	EA	1
4JR7525	25+7.5	EA	1
4JR0530	30+5	EA	1
4JR7530	30+7.5	EA	1
4JR0535	35+5	EA	1
4JR7535	35+7.5	EA	1
4JR0440	40+4	EA	1
4JR0540	40+5	EA	1
4JR7540	40+7.5	EA	1
4JR0545	45+5	EA	1
4JR7545	45+7.5	EA	1
4JR0550	50+5	EA	1
4JR7550	50+7.5	EA	1
4JR0555	55+5	EA	1
4JR1055	55+10	EA	1
4JR7555	55+7.5	EA	1
4JR0560	60+5	EA	1
4JR7560	60+7.5	EA	1
4JR1060	60+10	EA	1
4JR0570	70+5	EA	1
4JR7570	70+7.5	EA	1
4JR0580	80+5	EA	1
4JR7580	80+7.5	EA	1
4JR1080	80+10	EA	1

**CAPACITORS cont'd**

**Motor Start Capacitors –  
110/125 VAC**

Variable capacitance. Round, plastic can.



CATALOG NO.	uf	UOM	ORDER MULTIPLE
56-72	56-72	EA	1
88-108	88-108	EA	1
108-130	108-130	EA	1
124-156	124-156	EA	1
145-175	145-175	EA	1
161-193	161-193	EA	1
189-227	189-227	EA	1
200-240	200-240	EA	1
216-259	216-259	EA	1
233-292	233-292	EA	1
270-324	270-324	EA	1
324-388	324-388	EA	1
340-408	340-408	EA	1
378-440	378-440	EA	1
400-480	400-480	EA	1
460-552	460-552	EA	1
540-648	540-648	EA	1
590-708	590-708	EA	1
708-850	708-850	EA	1
829-995	829-995	EA	1
1000-1200	1000-1200	EA	1

**Motor Start Capacitors –  
220/250 VAC**

Variable capacitance. Round, plastic can.



CATALOG NO.	uf	UOM	ORDER MULTIPLE
43-53220	43-53	EA	1
56-72220	56-72	EA	1
72-88220	72-88	EA	1
88-108220	88-108	EA	1
108-130220	108-130	EA	1
124-156220	124-156	EA	1
145-175220	145-175	EA	1
161-193220	161-193	EA	1
189-227220	189-227	EA	1
216-259220	216-259	EA	1
233-292220	233-292	EA	1
270-324220	270-324	EA	1

**Motor Start Capacitors –  
330 VAC**

Variable capacitance. Round, plastic can.



CATALOG NO.	uf	UOM	ORDER MULTIPLE
43-53330	45-53	EA	1
72-88330	72-88	EA	1
88-108330	88-108	EA	1
108-130330	108-130	EA	1
124-156330	124-156	EA	1
145-175330	145-175	EA	1
161-193330	161-193	EA	1
189-227330	189-227	EA	1
216-259330	216-259	EA	1
270-324330	270-324	EA	1

**HARD START KITS**

**Torque Plus—Hard Start Kits**

Totally solid state, our DST 5 is just right for all permanent split capacitor (PSC) compressors from 1/2 to 10 H.P. It can be used on units that operate on 120 through 288 Volts. The DST 6 offers a larger capacitor for severely hard to start compressors. The DST 6 can be used on all PSC single phase compressors from 1 1/2 to 10 H.P. A unique combination of relay and safety timer. The capacitor is automatically disconnected in 0.5 seconds if the compressor fails to start.



CATALOG NO.	DESCRIPTION	UOM	ORDER MULTIPLE
DST-5	Torque Plus – 300% Torque Multiplier	EA	1
DST-6	Torque Plus – 500% Torque Multiplier	EA	1

**DiversiTech Hard Start Kits**

DiversiTech hard start kits reduce contractor call backs by boosting the starting capacitor for a compressor. This prevents home brownouts and improves homeowner satisfaction with your service. DiversiTech's hard start kits feature a potential relay that disconnects the start capacitor from the circuit at exactly the moment it is no longer needed to boost the compressor. This results in a precision compressor start even under hard starting conditions. Replaces the Kickstart KS-1 and the 5-n-1 kit.



CATALOG NO.	DESCRIPTION	UOM	ORDER MULTIPLE
HSK1	Hard Start Kit for 3.5 to 5HP Compressor	EA	1
HSK5	Hard Start Kit for 1 to 3HP Compressor	EA	1

**CONTACTORS**

**DiversiTech Definite Purpose Contactors**

Definite purpose contactors can be used for heating, air conditioning, refrigeration, data processing, and food service equipment. Quick connect terminals provide for easy wiring. This contactor comes as a two pole on a small frame.



CATALOG NO.	FL AMPS	COIL VAC	UOM	ORDER MULTIPLE
EC30224	30	24	EA	1
EC302120	30	120	EA	1
EC302240	30	240	EA	1
EC40224	40	24	EA	1
EC402120	40	120	EA	1
EC402240	40	240	EA	1

**Definite Purpose Contactors**

Three pole, large frame. 30-40 Amp contactors work with the DD11 auxiliary contacts, and 50-90 Amp contactors work with the D10 and D11 auxiliary contacts.



CATALOG NO.	FL AMPS	COIL VAC	UOM	ORDER MULTIPLE
DP30324	30	24	EA	1
DP303120	30	120	EA	1
DP303240	30	240	EA	1
DP40324	40	24	EA	1
DP403120	40	120	EA	1
DP403240	40	240	EA	1
DP50324	50	24	EA	1
DP503120	50	120	EA	1
DP503240	50	240	EA	1
DP60324	60	24	EA	1
DP603120	60	120	EA	1
DP603240	60	240	EA	1
DP75324	75	24	EA	1
DP753120	75	120	EA	1
DP753240	75	240	EA	1
DP90324	90	24	EA	1
DP903120	90	120	EA	1
DP903240	90	240	EA	1

**Definite Purpose Contactors**

Definite purpose contactors can be used for heating, air conditioning, refrigeration, data processing, and food service equipment. Quick connect terminals provide for easy wiring. This contactor comes as a four pole on a small frame and will work with the DD11 auxiliary contacts.



CATALOG NO.	FL AMPS	COIL VAC	UOM	ORDER MULTIPLE
DP304120	30	120	EA	1
DP30424	30	24	EA	1
DP304240	30	240	EA	1
DP304277	30	277	EA	1
DP404120	40	120	EA	1
DP40424	40	24	EA	1
DP404240	40	240	EA	1
DP404277	40	277	EA	1

**DiversiTech Three Pole Definite Purpose Contactors**

Definite purpose contactors can be used for heating, air conditioning, refrigeration, data processing, and food service equipment. Quick connect terminals provide for easy wiring. This contactor comes as a three pole on a large frame.



CATALOG NO.	FL AMPS	COIL VAC	UOM	ORDER MULTIPLE
EC30324	30	24	EA	1
EC303120	30	120	EA	1
EC303240	30	240	EA	1
EC40324	40	24	EA	1
EC403120	40	120	EA	1
EC403240	40	240	EA	1

**Definite Purpose Contactors**

Definite purpose contactors can be used for heating, air conditioning, refrigeration, data processing, and food service equipment. Quick connect terminals provide for easy wiring. This contactor comes as a single pole on a small frame and will work with the DD11 auxiliary contacts.



CATALOG NO.	FL AMPS	COIL VAC	UOM	ORDER MULTIPLE
DP30124	30	24	EA	1
DP301120	30	120	EA	1
DP301240	30	240	EA	1

**Definite Purpose Contactors**

Definite purpose contactors can be used for heating, air conditioning, refrigeration, data processing, and food service equipment. Quick connect terminals provide for easy wiring. This contactor comes as a two pole on a small frame and will work with the DD11 auxiliary contacts.



CATALOG NO.	FL AMPS	COIL VAC	UOM	ORDER MULTIPLE
DP25224	25	24	EA	1
DP252120	25	120	EA	1
DP252240	25	240	EA	1
DP30224	30	24	EA	1
DP302120	30	120	EA	1
DP302240	30	240	EA	1
DP40224	40	24	EA	1
DP402120	40	120	EA	1
DP402240	40	240	EA	1

## CONTACTORS cont'd

### Contactors Accessories

These are the replacement coils for the multiple sizes available for the definite purpose contactors.



CATALOG NO.	CONTACTOR FRAME SIZE	VOLTAGE	UOM	ORDER MULTIPLE
DA2V14	50-60 Amp	24	EA	1
DA2V02	50-60 Amp	120	EA	1
DA2V09	50-60 Amp	240	EA	1
DA2V06	50-60 Amp	480	EA	1
DA3V02	75-90 Amp	120	EA	1
DA3V09	75-90 Amp	240	EA	1
DA3V06	75-90 Amp	480	EA	1

### Contactors Accessories

D10 and D11 auxiliary contacts are designed for 50 Amp to 90 Amp 3 pole contactors while the DD11 auxiliary contacts are designed for 20 to 40 Amp 3 pole contactors.



CATALOG NO.	CONTACTOR FRAME SIZE	VOLTAGE	UOM	ORDER MULTIPLE
D10	1-N.O.	50-90 Amp	EA	1
D11	1-N.O. 1-N.C.	50-90 Amp	EA	1
DD11	1-N.O. 1-N.C.	20-40 Amp	EA	1

## TRANSFORMERS

### Transformers – Class 2 1585 UL Recognized

The transformers provide the power source for heating, air conditioning, or refrigeration systems.



CATALOG NO.	VA	PRI	SEC	UOM	ORDER MULTIPLE
T1401	40	120	24	EA	1
T1404	40	120/208/240	24	EA	1

### Transformers – Class 2 1585 UL Recognized

The transformers provide the power source for heating, air conditioning, or refrigeration systems.



CATALOG NO.	VA	PRI	SEC	UOM	ORDER MULTIPLE
T2401	40	120	24	EA	1
T2403	40	208/240	24	EA	1
T2404	40	120/208/240	24	EA	1

### Transformers – Class 2 1585 UL Recognized

The transformers provide the power source for heating, air conditioning, or refrigeration systems. These are multi mounted with wire connection secondary.



CATALOG NO.	VA	PRI	SEC	UOM	ORDER MULTIPLE
T3401	40	120	24	EA	1
T3403	40	120/208/240	24	EA	1
T3501	50	120/208/240	24	EA	1
T5401	40	120	24	EA	1

### Transformers – Class 2 1585 UL Recognized

Heavy duty with external fuse (T67XX) or circuit breaker (T77XX).



CATALOG NO.	VA	PRI	SEC	UOM	ORDER MULTIPLE
T6752	75	120/208/240	24	EA	1
T6753	75	120/208/240/480	24	EA	1
T7752	75	120/208/240/480	24	EA	1
T7750	100	120/208/240/480	24	EA	1
T7760	50	120/208/240/480	24	EA	1



## RELAYS

### General Purpose Relays – 9400 Series

This product features quick connect terminals with universal mounting with break away tabs.

CATALOG NO.	DESCRIPTION	AMPS RES	FLA/LRA@125V	FLA/LRA@250V	COIL VOLTAGE	UOM	ORDER MULTIPLE
D90-360	SPST-NO	18	12/60	8/48	24 VAC	EA	1
D90-362	SPST-NO	18	12/60	8/48	120 VAC	EA	1
D90-364	SPST-NO	18	12/60	8/48	240 VAC	EA	1
D90-370	SPDT	18	12/60	8/48	24 VAC	EA	1
D90-372	SPDT	18	12/60	8/48	120 VAC	EA	1
D90-374	SPDT	18	12/60	8/48	240 VAC	EA	1
D90-380	SPST NO+NC	18	12/60	8/48	24 VAC	EA	1
D90-382	SPST NO+NC	18	12/60	8/48	120 VAC	EA	1
D90-384	SPST NO+NC	18	12/60	8/48	240 VAC	EA	1



### General Purpose Relays – 8400 Series

This product features quick connect terminals with universal mounting with break away tabs



CATALOG NO.	DESCRIPTION	AMPS RES/IND	COIL VOLTAGE	UOM	ORDER MULTIPLE
D90-290Q	SPST-NO	16/8	24 VAC	EA	1
D90-291Q	SPST-NO	16/8	120 VAC	EA	1
D90-292Q	SPST-NO	16/8	240 VAC	EA	1
D90-293Q	SPDT	8/8	24 VAC	EA	1
D90-294Q	SPDT	8/8	120 VAC	EA	1
D90-295Q	SPDT	8/8	240 VAC	EA	1

### Potential Relays

The Potential Relay has SPST NC configurations and offers a variety of mounting positions.



CATALOG NO.	COIL VOLTAGE	PICK-UP		DROP-OUT MAX	UOM	ORDER MULTIPLE
		MIN	MAX			
DPR063	168	140	153	45	EA	1
DPR064	395	242	272	140	EA	1
DPR065	332	171	184	90	EA	1
DPR066	395	223	252	130	EA	1
DPR067	420	300	328	121	EA	1
DPR068	502	314	342	135	EA	1
DPR069	395	180	195	105	EA	1

### General Purpose Switching Relays

The Switching Relay has quick connect terminals for termination. The base is designed for easy replacement of competitive relays.



CATALOG NO.	COIL VOLTAGE	TERMINALS 1-2-3	TERMINALS 4-5-6	UOM	ORDER MULTIPLE
D-90340	24	POWER	POWER	EA	1
D-90341	110/120	POWER	POWER	EA	1
D-90342	208/240	POWER	POWER	EA	1

## FAN CENTERS

The fan centers offer low voltage for one and two speed fan motors; auxiliary circuits in heating cooling, or heating/ cooling applications. This has a DPDT Relay and is UL rated. There are color coded pre stripped leads on this center. This product has a 24V coil voltage, power, and duty rated contacts. It mounts directly to a 4in. electrical box.



CATALOG NO.	VOLTAGE	UOM	ORDER MULTIPLE
D-90113	120	EA	1
D-90118	208/240	EA	1

**FUSES**

**Dual Element Fuses – 250V**

Provides time delay for temporary over current conditions and motor running protection for heating and air conditioning equipment. Eliminates unnecessary maintenance from harmless overloads. U.L. Class RK 5, Standard for Safety 198E, Current Limiting Fuses, Interrupting Rating 200,000 Amps. rms. A.C.



7-CRNR40

CATALOG NO.	DESCRIPTION	UOM	ORDER MULTIPLE
7-CRNR15	15 Amps	EA	10
7-CRNR20	20 Amps	EA	10
7-CRNR25	25 Amps	EA	10
7-CRNR30	30 Amps	EA	10
7-CRNR35	35 Amps	EA	10
7-CRNR40	40 Amps	EA	10
7-CRNR45	45 Amps	EA	10
7-CRNR50	50 Amps	EA	10
7-CRNR60	60 Amps	EA	10

U.L. Class RK-5, Standard for Safety 198E, Current Limiting Fuses, Interrupting Rating 200,000 Amps. rms. A.C.

**Time Delay Fuses – 600V**

These plugs offer safe protection during momentary overload. No adapter necessary. U.L. Listed.



626-HASR15

CATALOG NO.	DESCRIPTION	UOM	ORDER MULTIPLE
626-HASR10	10 Amp	EA	10
626-HASR15	15 Amp	EA	10
626-HASR20	20 Amp	EA	10
626-HASR25	25 Amp	EA	10
626-HASR30	30 Amp	EA	10

U.L. Listed.

**Plug Fuses – Fast Acting**

Expels gases caused by the blowing fuse, but doesn't allow flame to escape. Glass top for safety against shock. Positive visual indication of OK condition or blown condition. Distinguishes between overload and dead short conditions. Magnifying center of face. Shapes of face openings identify ratings. Meets Federal Specification WF 791E/Gen. Type 791/1. Base "W" Fast acting fuses. U.L. Listed.



626-30

CATALOG NO.	DESCRIPTION	UOM	ORDER MULTIPLE
626-15	Plug Fuse Type TL – 15 Amp	EA	4
626-20	Plug Fuse Type TL – 20 Amp	EA	4
626-25	Plug Fuse Type TL – 25 Amp	EA	4
626-30	Plug Fuse Type TL – 30 Amp	EA	4

U.L. Listed.

**One Time Fuses**

Protection to lighting, heating, and other non transient circuits. U.L. Class H, Standard for Safety 1988, One Time Fuse Interrupting Rating 10,000 Amps. rms. A.C.



7-10KOTN40

CATALOG NO.	DESCRIPTION	UOM	ORDER MULTIPLE
7-10KOTN30	30 Amps	EA	10
7-10KOTN35	35 Amps	EA	10
7-10KOTN40	40 Amps	EA	10
7-10KOTN45	45 Amps	EA	10
7-10KOTN50	50 Amps	EA	10
7-10KOTN60	60 Amps	EA	10

U.L. Class H, Standard for Safety 1988, One Time Fuse Interrupting Rating 10,000 Amps. rms. A.C.

**Time Delay Plug Fuses**

These plugs offer safe protection during momentary overload. No adapter necessary. U.L. Listed.



626-30T

CATALOG NO.	DESCRIPTION	UOM	ORDER MULTIPLE
626-10T	Type "T" Plug Fuse – 10 Amp	EA	4
626-15T	Type "T" Plug Fuse – 15 Amp	EA	4
626-20T	Type "T" Plug Fuse – 20 Amp	EA	4
626-25T	Type "T" Plug Fuse – 25 Amp	EA	4
626-30T	Type "T" Plug Fuse – 30 Amp	EA	4

U.L. Listed.

**Type "S" Non-Tamper Fuses**

Provides specific overcurrent protection. Time delay element protects against premature blowing from motors in air conditioners or compressors. Visual indication of good or blown condition. U.L. Listed. C.S.A. Approved.



626-30S

CATALOG NO.	DESCRIPTION	UOM	ORDER MULTIPLE
626-3S	Type "S" Fuse – 3.2 Amp	EA	4
626-4S	Type "S" Fuse – 4 Amp	EA	4
626-5S	Type "S" Fuse – 5 Amp	EA	4
626-6S	Type "S" Fuse – 6.25 Amp	EA	4
626-10S	Type "S" Fuse – 10 Amp	EA	4
626-15S	Type "S" Fuse – 15 Amp	EA	4
626-20S	Type "S" Fuse – 20 Amp	EA	4
626-25S	Type "S" Fuse – 25 Amp	EA	4
626-30S	Type "S" Fuse – 30 Amp	EA	4

U.L. Listed. C.S.A. Approved.

**FUSES cont'd**

**In-Line Fuse Holder**

For fusing all control circuits up to 30 amp. Features rigid plastic protective covering for each fuse. Used on AC and DC circuits. U.L. Listed.

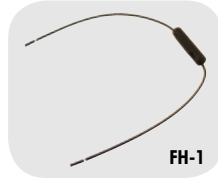

CATALOG NO.	DESCRIPTION	UOM	ORDER MULTIPLE
<b>FH-1</b>	In-Line Fuse Holder	EA	10

U.L. Listed.

**Fuse Pullers**

Our fuse pullers are used to safely pull fuses



CATALOG NO.	DESCRIPTION	UOM	ORDER MULTIPLE
<b>626-38071</b>	Fuse Puller – For Fuse Sizes 1/4" to 1/2"	EA	1
<b>626-38073</b>	Fuse Puller – For Fuse Sizes 1" to 1-3/4"	EA	1

**Fuseblocks**

The fuse blocks are designed to allow the fuse to blow or burn out before the component can be damaged.



CATALOG NO.	DESCRIPTION	UOM	ORDER MULTIPLE
<b>626-23133</b>	Fuseblock – 1 Pole Screw Class H, 250V	EA	1
<b>626-23233</b>	Fuseblock – 2 Pole Screw Class H, 250V	EA	1
<b>626-23333</b>	Fuseblock – 3 Pole Screw Class H, 250V	EA	1
<b>626-26311</b>	Fuseblock – 3 Pole Box Lug Class H, 250V	EA	1

**Blade (Auto) Fuses**

These fuses are fast acting low voltage supplementary fuses, automotive blade style fuse.



CATALOG NO.	DESCRIPTION	UOM	ORDER MULTIPLE
<b>626-AT0003</b>	Blade Fuse – 3 Amp – Purple, pack of 5	EA	100
<b>626-AT0005</b>	Blade Fuse – 5 Amp – Tan, pack of 5	EA	100

**Fuse Adapters**

Fuse adapters are used to retrofit fuses into existing installations.



CATALOG NO.	DESCRIPTION	UOM	ORDER MULTIPLE
<b>626-38632</b>	Fuse Adapter – 60 to 30 Reducer for Class H, 250V	EA	1
<b>626-38636</b>	Fuse Adapter – 60 to 30 Reducer for Class H, 600V	EA	1

**Box Cover Units**

The maximum amps on this box cover unit are 15 and the maximum AC voltage of 125. These units are designed for use with the Type T plug fuses. U.L. Listed and C.S.A. Certified.



CATALOG NO.	DESCRIPTION	UOM	ORDER MULTIPLE
<b>620-608</b>	Switch/Fuse Combo (ESSU)	EA	1
<b>620-6081</b>	Plug Fuse Base Only (ESOU)	EA	1
<b>620-6082</b>	Receptacle/Fuse Combo (ESRU)	EA	1
<b>620-6083</b>	Switch/Fuse Combo Square (ESSY)	EA	1

U.L. Listed and C.S.A. Certified.

**TIME DELAYS**

**Adjustable Delay on Break Timer**

Adjusts from 6 seconds to 8 minutes. Spin-proof knob. Works with 24, 120 or 240 VAC control circuits. Supports up to 1.0 Amps. Two wire hookup for easy installation. Solid state with quick disconnect terminals. Mounts with one self-tapping screw. Conformal coated circuitry protects against moisture and shock. UR recognized for USA and Canada. Works with anticipator type thermostats.

**HOW IT WORKS:** Immediately upon application of power, the Delay on Break timer enables circuit operation. Once power is interrupted, the circuit opens for the time set on the dial. After the time period elapses, the circuit closes, allowing the protected motor or compressor to start. For typical HVAC applications, the operation of the timer is transparent and will go unnoticed.



CATALOG NO.	DESCRIPTION	UOM	ORDER MULTIPLE
<b>ADB-1</b>	Adjustable Delay on Break	EA	1
<b>ADB-2</b>	Adjustable Delay on Break w/Wire Leads	EA	1

**Adjustable Delay on Make Timer**

Ideal for random starting of multiple units. Adjusts from 6 seconds to 8 minutes. Spin proof knob. Works with 24, 120 or 240 VAC control circuits. Supports up to 1.0 Amps. Two wire hookup for easy installation. Solid state with quick-disconnect terminals. Mounts with one self-tapping screw. Conformal coated circuitry protects against moisture and shock. UR recognized for US and Canada. Works with anticipator type thermostats. **HOW IT WORKS:** These timers delay circuit closure upon application of power. Only after the set time period elapses and power remains ON will the circuit close, allowing the protected motor or compressor to start. For typical HVAC installations, timers are adjusted to random times to prevent power circuit overloads, thus are often called random start timers.



CATALOG NO.	DESCRIPTION	UOM	ORDER MULTIPLE
<b>ADM-1</b>	Adjustable Delay on Make	EA	1
<b>ADM-2</b>	Adjustable Delay on Make w/Wire Leads	EA	1

**MONITORS**

**Digital Three Phase Line Voltage Monitor**

Offers continuous protection against voltage anomalies which can damage compressors, motors and other sensitive electrically operated devices.

**PROTECTION:** Loss of Phase, Phase Reversal, Voltage Imbalance, Low Voltage, High Voltage

**DISPLAY:** Large custom LCD display indicates all operating conditions at a glance. Three large sets of digits provide easy system troubleshooting.

**VOLTMETER:** Three independent voltmeters read both line and contactor load (backside) voltages.

**MONITORED VOLTAGE:** 160 to 600 Volts 50-60 Hz.

**POWER SUPPLY:** Power for the WPC-500 is automatically derived from any active phase. System operation is not dependent on the control voltage or a specific phase for power.

**CONTROL VOLTAGE:** 19-277 VAC. Anticipator load is provided for operation with 24 volt electronic and mechanical thermostats.

**OPERATING VOLTAGE SET POINT:** 175 to 650 VAC. Digitally adjustable in one volt increments.

**VOLTAGE TRIP POINT:** Adjustable in 1% increments between 6% and 18% of selected operating voltage. Restart voltage set point (hysteresis) fixed at cutout voltage + 3%.

**VOLTAGE SYMMETRY:** Adjustable imbalance trip point from 2% to 25% of selected operating voltage.

**RESPONSE TIMES:**

Phase Loss/Reversal: 100 mS max.

Imbalance: Adjustable Response Timer

Over or Under Voltage: Adjustable Response Timer

**LOCKOUT DELAY TIMER:** Fully adjustable 0 to 720 Seconds (0 to 12 minutes). Digital display shows remaining time and user set points.

**SEQUENTIAL START TIMER:** 0 to 30 seconds in one second increments.

**RESPONSE TIMER:** 0.1 to 20 Seconds. Digital display shows remaining time and user set points.

**MEMORY:** Up to 25 past fault conditions are stored for later retrieval and analysis. The faults may be displayed or cleared by the front panel buttons.



**DTP-3**

**Digital Single Phase Line Voltage Monitor**

Automatic voltage monitor and control system. Continuously measures incoming line voltage, allowing detection of any voltage outside the tolerances that you set. If these limits are exceeded, the response timer begins counting. You may also set response time – a short time for a quick response or a long time to avoid nuisance tripping. If the voltage remains outside the tolerance after the time has elapsed, the DSP-1 will turn off its output relay and protect your device. While output is off, an additional delay timer activates to avoid rapid restarts.

**FEATURES:**

- Digital voltmeter displays instantaneous line voltage;
- Automatic voltage tester adjusts from 90 to 300 volts;
- Adjustable response timer (0.1 to 10 sec.) prevents nuisance tripping;
- Adjustable delay timer (1 to 720 sec.) prevents rapid restarts;
- Digital display makes for easy viewing and operation

**SPECIFICATIONS:**

- Voltmeter: 70 to 325 Volts
- Voltage Set Point: 90 to 300 Volts
- Tolerance Limits: 6 to 18%
- Response Timer: 0.1 to 10 seconds
- Delay Timer: 1 to 720 seconds
- Output Relay: 10 Amps, 250 VAC resistive, single-pole/double-throw
- Control Input: 18 to 250 VAC with anticipator load for 24 volt thermostats



**DSP-1**

CATALOG NO.	DESCRIPTION	UOM	ORDER MULTIPLE
<b>DSP-1</b>	Digital Single Phase Motor Protector	EA	1

CATALOG NO.	DESCRIPTION	UOM	ORDER MULTIPLE
<b>DTP-3</b>	Digital 3-Phase Motor Protector	EA	1

## COMPRESSOR HEATERS

### Compressor Heaters, U.L. listed, CSA certified

Extends the life of air conditioners and refrigeration compressors. Corrosion resistant exterior. High temperature silicone rubber element and insulated leads. Voltages through 600. Wattage for each model matches compressor requirements. Moisture proof, easy to install. Nominal power consumption. UL listed, CSA certified.

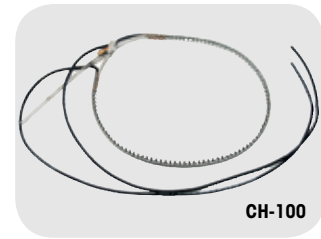

CH-100

CATALOG NO.	RATED VOLTS	RATED WATTS	FITS COMPRESSOR	GIRTH DIMENSIONS		SHAPE	UOM	ORDER MULTIPLE
				MIN.	MAX.			
<b>CH-100</b>	240	50	Bendix/Westinghouse: C, D	30-3/16"	37"	OVL	EA	1
<b>CH-100-3</b>	480		Copeland: Y Hitachi: 753FH3-H, 1001FH4-H Tecumseh: B, C, CL, AG, AV Carlisle: W (70-88)				EA	1
<b>CH-101</b>	240	54	Aspera: H	27-7/16"	34-1/4"	OVL	EA	1
<b>CH-101-1</b>	208		Bendix/Westinghouse: E				EA	1
<b>CH-101-2</b>	120		Bristol/Sunstrand: H10A, H21A,				EA	1
<b>CH-101-3</b>	480		Carrier: 6A25, 26, 28, 29, 6A35, Copeland: CR				EA	1
<b>CH-102</b>	240	60	Aspera: J	25-3/4"	32-9/16"	OVL	EA	1
<b>CH-102-2</b>	120		Bristol/ Sunstrand: H10C, H20C,				EA	1
<b>CH-102-3</b>	480		Trane: D4340/7669				EA	1
<b>CH-196</b>	240	40	Copeland	19-7/8"	26-5/8"	RND	EA	1
<b>CH-196-2</b>	120		6" Scroll				EA	1
<b>CH-196-3</b>	480						EA	1
<b>CH-196-6</b>	575						EA	1
<b>CH-230</b>	240	70	Copeland	21-5/8"	28-1/2"	RND	EA	1
<b>CH-230-3</b>	480		7-1/2" Scroll				EA	1
<b>CH-230-6</b>	575						EA	1
<b>CH-103</b>	240	45	Bendix/Westinghouse: A	24-3/4"	31-9/16"	OVL	EA	1
<b>CH-103-2</b>	120		Copeland: RR, SR Tecumseh: AB, AW				EA	1
<b>CH-104</b>	240	75	Bristol/Sunstrand: H10G, H20G,	41-1/2"	48-5/16"	RND	EA	1
<b>CH-104-3</b>	480		Carrier: 6A88				EA	1
<b>CH-105</b>	240	50	Copeland: VR Trane: D4340/7670 Westinghouse: CD072, CD090	32-1/2"	39-5/16"	RND	EA	1
<b>CH-135</b>	240	45	Copeland: JR	20-5/16"	27-1/8"	OVL	EA	1
<b>CH-135-2</b>	120		Tecumseh: AK				EA	1
<b>CH-197</b>	240	25	Fedders/Chrysler: 2870908 Sanyo: CR15F, CR20F, CR33F	13-3/4"	20-9/16"	RND	EA	1
<b>CH-202-3</b>	480	70	Copeland: BR	33-3/4"	36-3/4"	RND	EA	1
<b>CH-280</b>	240	70	Copeland 7.25 Scroll	20-4/5"	28"	RND	EA	1

**ELECTRICAL SUPPLIES**

**Electrical Toggle Switches**

Side wire design with automatic grounding and large binding head terminal screws for fast wiring. Lubricated cam provides smooth lever action. U.L. Listed. C.S.A. Certified. Verified to Federal Spec. WS896E



CATALOG NO.	DESCRIPTION	UOM	ORDER MULTIPLE
<b>620-600</b>	20A-1 HP 120V, Single Pole, Brown	EA	10
<b>620-601</b>	20A-1 HP 120V, Single Pole, Ivory	EA	10
<b>625-CS120W</b>	20A-1HP 120V Single Pole, White	EA	10
<b>620-602</b>	20A-1 HP 120V, 3-Way, Brown	EA	10
<b>620-603</b>	20A-1 HP 120V, 3-Way, Ivory	EA	10
<b>625-1301W</b>	15A-1/2HP 120V Single Pole, White	EA	10
<b>620-604</b>	15A-1/2 HP 120V, Single Pole, Brown	EA	10
<b>620-605</b>	15A-1/2 HP 120V, Single Pole, Ivory	EA	10
<b>620-606</b>	15A-1/2 HP 120V, 3-Way, Brown	EA	10
<b>620-607</b>	15A-1/2 HP 120V, 3-Way, Ivory	EA	10

U.L. Listed. C.S.A. Certified. Verified to Federal Spec. WS896E.

**Electrical Outlet Boxes, Extensions and Covers**

We have 4in. steel octagon boxes, extensions, and covers available. Conforms to Article 370 of NEC. U.L. Listed.



CATALOG NO.	DESCRIPTION	UOM	ORDER MULTIPLE
<b>620-300</b>	1-1/2" Deep, 1/2" and 3/4" K.O.s	EA	50
<b>620-301</b>	2-1/8" Deep, 1/2" and 3/4" K.O.s	EA	25
<b>620-302</b>	1-1/2" Deep, 1/2" K.O. Extension	EA	50
<b>620-303</b>	Flat Blank Cover	EA	50
<b>620-304</b>	Flat, Duplex Receptacle Cover	EA	50
<b>620-306</b>	Flat Cover 1/2" K.O. in Center	EA	50

Conforms to Article 370 of NEC. U.L. Listed.

**Electrical Outlet Boxes, Extensions and Covers**

We have 4 11/16in. steel square boxes, extensions, and covers available. Conforms to Article 370 of NEC. U.L. Listed.



CATALOG NO.	DESCRIPTION	UOM	ORDER MULTIPLE
<b>620-500</b>	2-1/8" Deep, 1/2" and 3/4" K.O.s	EA	25
<b>620-502</b>	Raised Cover for Single Device	EA	25

Conforms to Article 370 of NEC. U.L. Listed.

**Electrical Duplex Receptacles**

Automatic grounding for fast installation. Heavy duty mounting strap for additional assembly strength. Copper alloy power/ground contacts for optimum continuity. Side wire design with large binding head terminal screws for fast wiring. U.L. Listed. C.S.A. Certified (NEMA 5 15 Type).



CATALOG NO.	DESCRIPTION	UOM	ORDER MULTIPLE
<b>620-700</b>	15A, 125V, Brown	EA	10
<b>620-701</b>	15A, 125V, Ivory	EA	10
<b>625-CR15W</b>	15A 125V, White	EA	10
<b>620-702</b>	20A, 125V, Brown	EA	10
<b>620-703</b>	20A, 125V, Ivory	EA	10
<b>625-CR20W</b>	20A 125V, White	EA	10
<b>620-704</b>	15A, 125V, Brown – Residential	EA	10
<b>620-705</b>	15A, 125V, Ivory – Residential	EA	10
<b>625-270W</b>	15A 125V, White – Residential	EA	10

U.L. Listed. C.S.A. Certified (NEMA 5-15 Type).

**Electrical Outlet Boxes, Extensions and Covers**

We have 4in. steel square boxes, extensions, and covers available. Conforms to Article 370 of NEC. U.L. Listed.



CATALOG NO.	DESCRIPTION	UOM	ORDER MULTIPLE
<b>620-400</b>	1-1/4" Deep, 1/2" K.O.s	EA	50
<b>620-401</b>	2-1/8" Deep, 1/2" and 3/4" K.O.s	EA	25
<b>620-403</b>	1-1/2" Deep, 1/2" K.O.s	EA	50
<b>620-404</b>	1-1/2" Deep, 1/2" and 3/4" K.O.s Extension	EA	50
<b>620-405</b>	Flat Cover 1/2" K.O. in Center	EA	50
<b>620-406</b>	Flat Blank Cover	EA	50
<b>620-408</b>	Flat, One Toggle Switch Cover	EA	50
<b>620-409</b>	Flat, One Duplex Receptacle Cover	EA	50
<b>620-411</b>	One Switch and One Duplex Receptacle Cover	EA	50

Conforms to Article 370 of NEC. U.L. Listed.

### Electrical Outlet Boxes, Extensions and Covers

Standard steel utility (Handy) boxes and covers.



CATALOG NO.	DESCRIPTION	UOM	ORDER MULTIPLE
620-200	1-1/2" Deep, 1/2" K.O.s	EA	50
620-201	1-7/8" Deep, 1/2" K.O.s	EA	50
620-202	2-1/8" Deep, 1/2" K.O.s	EA	50
620-20134	1-7/8" Deep, 3/4" K.O.s	EA	50
620-252	Flat, Two Duplex Receptacle Cover	EA	100
620-253	Flat, Toggle Switch Cover	EA	100
620-254	Flat Blank Cover	EA	100
620-255	Flat Cover 1/2" K.O.	EA	100

Conforms to Article 370 of NEC. U.L. Listed.

### Switch/Plug Combo

Use with air handlers and condensate pumps. Touch-A-Matic design, with exclusive spring loaded steel ball mechanism for smooth, positive contact movement. Small neon pilot light ON when switch is ON, is built-in to the switch on switch/receptacle.



CATALOG NO.	DESCRIPTION	UOM	ORDER MULTIPLE
620-274W	White 2P 3W Grounding—15A 120V	EA	10

U.L. Listed. C.S.A. Approved.

### Switch Covers

Our switch covers come with gas, oil, or emergency already printed on them.



CATALOG NO.	SIZE	TYPE	DESCRIPTION	UOM	ORDER MULTIPLE
625-S17	4" X 4"	Gas	4" Square Box	EA	1
625-S16	4-1/4" X 2-3/4"	Gas	Utility/Handy Box	EA	1
625-S15	4-1/2" X 2-1/2"	Gas	Flush Mount	EA	1
625-S14	4" X 4"	Oil	4" Square Box	EA	1
625-S13	4-1/4" x 2-3/4"	Oil	Utility/Handy Box	EA	1
625-S19	4-1/2" X 2-1/2"	Oil	Flush Mount	EA	1
625-S20	4-3/4" X 2-1/2"	Emergency	Switch Plate	EA	1
625-S21	4-1/4" X 2-7/10"	Emergency	Switch Plate	EA	1
625-S18	3/4"		Switch Guard (Wall plate/ switch not included)	EA	1

### Homeline Circuit Breakers

Homeline circuit breakers provide the high level of protection you expect from Square D. No other name in circuit protection is more trusted for reliability and performance than Square D. These are the only breakers accepted in genuine Square D Homeline Load Centers.



CATALOG NO.	DESCRIPTION	UOM	ORDER MULTIPLE
625-GS15H	Single Pole, 15A	EA	10
625-GS20H	Single Pole, 20A	EA	10
625-GS30H	Single Pole, 30A	EA	10
625-GS40H	Single Pole, 40A	EA	10
625-GS50H	Single Pole, 50A	EA	10
625-GD15H	Two Pole, 15A	EA	10
625-GD20H	Two Pole, 20A	EA	10
625-GD30H	Two Pole, 30A	EA	10
625-GD40H	Two Pole, 40A	EA	10
625-GD50H	Two Pole, 50A	EA	10
625-GD60H	Two Pole, 60A	EA	10
625-GD100	Two Pole, 100A	EA	10

### Plastic Wall Plates

Non flammable thermoplastic, phenolic or urea material. Color matched 1/2in. long steel mounting screws furnished. Smooth surface – no recessed areas to collect dirt, discolor. Easy to clean. Full weight and thickness provide high dielectric strength, minimum moisture absorption, impact resistance. Warp resistant, fit flush to wall. U.L. Listed. C.S.A. Approved.



CATALOG NO.	DESCRIPTION	UOM	ORDER MULTIPLE
625-2139W	Double Toggle Cover – White	EA	10
625-2132B	Duplex Receptacle Cover – Brown	EA	25
625-2132V	Duplex Receptacle Cover – Ivory	EA	25
625-2132W	Duplex Receptacle Cover – White	EA	10
625-2134B	Single Toggle Cover – Brown	EA	25
625-2134V	Single Toggle Cover – Ivory	EA	25
625-2134W	Single Toggle Cover – White	EA	25

U.L. Listed. C.S.A. Approved.

**ELECTRICAL SUPPLIES cont'd**

**Toggle Switches**

These switches are available in single pole double pole. They are UL listed and furnished with screw terminals. The ratings are A:20A 125VAC, 20 250 VAC, 1 HP at 120 240 V and B 15A 125/250 VAC, ¾ HP at 240 V.



CATALOG NO.	DESCRIPTION	RATING	UOM	ORDER MULTIPLE
TS-1	Toggle Switch – SP-ST – ON/OFF	A	EA	1
TS-3	Toggle Switch – SP-DT-CO – ON/OFF/ON	B	EA	1
TS-4	Toggle Switch – DP-ST – ON/OFF	A	EA	1
TS-5	Toggle Switch – DP-DT – ON/OFF	A	EA	1

**Dryer Receptacle**

Our dryer receptacles are UL listed and CSA approved.



CATALOG NO.	DESCRIPTION	UOM	ORDER MULTIPLE
625-1225	Dryer Receptacle 30A 125/250V NEMA 14-30	EA	10

U.L. Listed. C.S.A. Approved.

**Toggle Switch Cover**

Weatherproof body for toggle switches up to 15/16" long.



CATALOG NO.	DESCRIPTION	UOM	ORDER MULTIPLE
625-B1	Toggle Switch Cover	EA	5

**Power Supply Cord (Pigtails)**

Stranded bare copper conductors. Grounding conductors. PVC jacket. Right and straight angle male plug. 110 Volt. 16 AWG x 6' long. SPT 2.



CATALOG NO.	DESCRIPTION	UOM	ORDER MULTIPLE
625-16-6	Power Supply Cord – Straight Plug	EA	50
625-16-690	Power Supply Cord – 90 Degree Plug	EA	50

**ELECTRICAL TAPES**

**Scotch 3M Super 33+ Electrical Tape**

Premium grade, 7 mil thick, all-weather vinyl insulating tape. Performs continuously in a temperature ambient of up to 220°F and as low as 0°F. Resealable plastic case. Made in USA.



CATALOG NO.	DESCRIPTION	UOM	ORDER MULTIPLE
ET33	Super 33+ Electrical Tape – 3/4" x 66'	EA	10

**Scotch 3M Super 88 Electrical Tape**

Premium grade, 8.5 mil thick, all-weather vinyl insulating tape. Performs continuously in a temperature ambient of up to 220°F and as low as 0°F. Excellent resistance to abrasion, moisture, acids and corrosion. Packaged in a resealable plastic case. Made in the USA.



CATALOG NO.	DESCRIPTION	UOM	ORDER MULTIPLE
ET44	Super 88 Electrical Tape – 3/4" x 66'	EA	10

**Scotch 35 Vinyl Electrical Tape**

This 7 mil premium grade electrical vinyl tape stretches to conform to virtually any shape that requires color-coded insulation. Abrasion and weather resistant. Measures 3/4" x 66'.



CATALOG NO.	DESCRIPTION	UOM	ORDER MULTIPLE
ET35N	Vinyl Electrical Tape – Orange	EA	10
ET35G	Vinyl Electrical Tape – Green	EA	10
ET35R	Vinyl Electrical Tape – Red	EA	10
ET35W	Vinyl Electrical Tape – White	EA	10

**Economy Electrical Tape**

This tape is suitable for use up to 175 F (80C) and not more than 600V. The electrical tape is excellent for adhesion and UL listed.



CATALOG NO.	DESCRIPTION	UOM	ORDER MULTIPLE
6-3460	3/4" x 60' Economy Electrical Tape	EA	10

**Glass Cloth, Moisture Sealing, and Economy Electrical Tapes**

This is a woven glass cloth tape designed to operate in 600 volt dry applications, requiring high mechanical strength and resistance to high temperatures. The glass cloth is specially treated and prepared to provide corrosion free protection. It will not shrink, rot, or burn and has a high tensile strength. It contains pressure sensitive thermosetting adhesive which performs as Class B temperature (266 degrees F / 130 degrees C). Provides heat stable insulation for hot spot applications. Highlight: Color White. Width 1/2in. Length 66 ft. Thickness 7 mil. Tensile Strength (2) 150 lb./in. Material Glass Cloth.



CATALOG NO.	DESCRIPTION	UOM	ORDER MULTIPLE
GC275	1/2" x 66' Glass Cloth Electrical Tape by 3M	EA	10
GC277	3/4" x 66' Glass Cloth Electrical Tape by 3M	EA	10
ET130C1	1" x 30' Moisture Sealing Splicing Tape by 3M	EA	24
ET22	3/4" x 66' Hiawatha Electrical Tape by 3M	EA	10
AT-1700	3/4" x 66' TemFlex™ by 3M	EA	10



**TERMINALS, CONNECTORS**

**Compressor Repair Kit**

Finally, a product that simplifies the repair of burned or damaged spade terminals when reconnecting or replacing a compressor. Fits both non burned and burned terminals. Connects to the compressor via precision brass cylinders that fit over the terminals and connect with stainless steel set screws. Wires are permanently attached. Standard factory 600V, 65 strand machine wire. Easy to install and guaranteed for the life of the compressor.



CATALOG NO.	DESCRIPTION	UOM	ORDER MULTIPLE
<b>TLC-3-8</b>	3 Wire, 8 Gauge Connection Kit	EA	1
<b>TLC-3-10</b>	3 Wire, 10 Gauge Connection Kit	EA	1
<b>TLC-3-12</b>	3 Wire, 12 Gauge Connection Kit	EA	1

**Replacement Compressor Leads**

Extreme heat within compressors typically causes failure of wiring insulation. This can cause corrosion to the inner strands of copper within the wire used for compressor hook up. This reduces the power flow to the compressor causing the unit to overheat and can prevent the compressor from starting. A MINIMUM of 12in. of wire must be removed. The DiversiTech Replacement Compressor Leads are ideal for replacing this corroded wiring. 24in. leads also available for replacing wire all the way to the contactor and capacitor.



CATALOG NO.	DESCRIPTION	UOM	ORDER MULTIPLE
<b>CC33</b>	Compressor Leads – 12" with Butt, pack of 3	PK	1
<b>CC33-18</b>	Compressor Leads – 18" with Butt, pack of 3	PK	1
<b>CC33-24</b>	Compressor Leads – 24" with Ring, pack of 3	PK	1

**Grommets – Vinyl (By Panel Hole Size)**

Grommets safely route cables and wires through sharp edged cutouts.



CATALOG NO.	DESCRIPTION	UOM	ORDER MULTIPLE
<b>GV04</b>	Grommets – 1/4", pack of 18	PK	1
<b>GV05</b>	Grommets – 5/16", pack of 15	PK	1
<b>GV06</b>	Grommets – 3/8", pack of 13	PK	1
<b>GV07</b>	Grommets – 7/16", pack of 12	PK	1
<b>GV08</b>	Grommets – 1/2", pack of 12	PK	1
<b>GV10</b>	Grommets – 5/8", pack of 7	PK	1
<b>GV12</b>	Grommets – 3/4", pack of 3	PK	1
<b>GV14</b>	Grommets – 7/8", pack of 4	PK	1
<b>GV16</b>	Grommets – 1", pack of 4	PK	1
<b>GVA1</b>	Assortment – Small – GV04, GV05, GV06, GV07, GV08, pack of 15	PK	1
<b>GVA2</b>	Assortment – Large – GV08, GV10, GV12, GV14, GV16, pack of 5	PK	1

Sizes shown above also available in 100 packs.

**Transparent Plastic Boxes with Terminal Assortments**

Boxes are made of soft, pliable, durable K Resin with 18 compartments containing the most popular terminals, including hi temp and compressor terminals.



CATALOG NO.	DESCRIPTION	UOM	ORDER MULTIPLE
<b>PA10</b>	180 Terminals (10 Each Kind)	EA	1
<b>PA25</b>	360 Terminals (20 Each Kind)	EA	1
<b>PA25AP</b>	Appliance Parts Technician Assortment (mostly Hi-Temp)	EA	1
<b>PA18</b>	"K" Resin Plastic Box Only	EA	1

**Compartmented Storage Boxes**

These boxes can be used to store your compressor terminals, nylon ties and clamps.



CATALOG NO.	DESCRIPTION	UOM	ORDER MULTIPLE
<b>MB21</b>	21 Compartmented Metal Box	EA	1
<b>MB22</b>	21 Compartmented Metal Box w/230 popular EA items including hi-temp and compressor terminals, nylon ties and clamps	EA	1

**Heat Shrink Tubing – Polyolefin 50% Shrink, Black Commercial Grade**

Our shrinking tube is economical and mechanically tough heat shrinkable tubing used for insulating, jacketing and identification.



CATALOG NO.	DESCRIPTION	UOM	ORDER MULTIPLE
<b>HS03</b>	3/16" I.D. Expanded – 4" Long, pack of 8	PK	1*
<b>HS04</b>	1/4" I.D. Expanded – 4" Long, pack of 7	PK	1*
<b>HS06</b>	3/8" I.D. Expanded – 4" Long, pack of 6	PK	1*
<b>HS08</b>	1/2" I.D. Expanded – 4" Long, pack of 5	PK	1*
<b>HS012</b>	3/4" I.D. Expanded – 4" Long, pack of 4	PK	1*
<b>HS16</b>	1" I.D. Expanded – 4" Long, pack of 3	PK	1*
<b>HS24</b>	1.5" I.D. Expanded – Per Foot	EA	1'
<b>HS32</b>	2" I.D. Expanded – Per Foot	EA	1'
<b>HSA1</b>	Assorted 3/16", 1/4", 3/8" – 4" Long, pack of 7	PK	1
<b>HSA2</b>	Assorted 1/2", 3/4", 1" – 4" Long, pack of 4	PK	1

Available in lengths up to 250 ft.

\*These items are also available in bulk. To order, enter the catalog number followed by the letter "B". For example, HS03B is the bulk part number for HS03. Bulk items are priced and shipped by the foot.

## THERMAL CONTROLS

### Fusible Links

Fusible Links are temperature sensitive, one time devices. Engineered as safety links, they open the circuit if the designed limit temperature is reached.

CATALOG NO.	FUSIBLE TEMP °F	TYPE	PRONG TYPE	QTY/PACK	UOM	ORDER MULTIPLE
<b>HFL-4257</b>	257°	In-Line		pack of 4	PK	1
<b>HFL-4300</b>	300°	In-Line		pack of 4	PK	1
<b>HFL-4333</b>	333°	In-Line		pack of 4	PK	1
<b>HFL-5257</b>	257°	Face Plate	Straight	pack of 2	PK	1
<b>HFL-5258</b>	257°	Face Plate	Right Angle	pack of 2	PK	1
<b>HFL-5300</b>	300°	Face Plate	Straight	pack of 2	PK	1
<b>HFL-5301</b>	300°	Face Plate	Right Angle	pack of 2	PK	1
<b>HFL-5333</b>	333°	Face Plate	Straight	pack of 2	PK	1



### Replacement Element Kits

Field repair damaged element sections of electric heaters. Each kit contains a specific KW replacement element, two ceramic terminal insulator sets, plated bolts, nuts and washers.

CATALOG NO.	WATTAGE AT		IN PLACE LENGTH (INCHES)		UOM	ORDER MULTIPLE
	240V	208V	MINIMUM	MAXIMUM		
<b>HEK-100</b>	1000	750	14"	35"	EA	1
<b>HEK-200</b>	2000	1500	26"	65"	EA	1
<b>HEK-400</b>	4000	3000	45"	135"	EA	1
<b>HEK-500</b>	5000	3750	54"	162"	EA	1



### Sequencers

The sequencers are used in electric heat systems to stage blower motors and heating elements. All sequencers are for 24V control.

CATALOG NO.	NO. CIRCUITS	KILXON NO.	SWITCH CONFIGURATION	DELAY ON TIME MIN.-MAX. SECONDS	DELAY OFF TIME MIN.-MAX. SECONDS	UOM	ORDER MULTIPLE
<b>HDR-101</b>	1 Main	60000A0211	SPST-NO	1-24	45-75	EA	1
<b>HDR-102</b>	1 Main	60000A0147	SPST-NO	30-75	1-40	EA	1
<b>HDR-201</b>	2 Main	60000E0110	DPST-NO	1-24	45-75	EA	1
<b>HDR-202</b>	2 Main	60000E0109	DPST-NO	30-70	1-40	EA	1
<b>HDR-211</b>	2 Main Staged	60200A0117	DPST-NO	30-110	1-40	EA	1
<b>HDR-212</b>	2 Main Staged	60200A0127	DPST-NO	1-25	50-110	EA	1
<b>HDR-221</b>	3 Main Staged	51172-131-1	DPST-NO SPST-NO	1-25	50-110	EA	1
<b>HDR-222</b>	4 Main Staged	51172-131-2	2 DPST-NO	1-40	50-110	EA	1



### Manual Reset Fire Stat

This bi metal switch is used as a manual reset. When temperature condition is met, the device opens. The manual reset can only be reset after proper cool down of the switch. The HMR 130 is a popular fire stat in ducted air distribution systems. Should temperatures in the duct exceed 130 degree F, the switch opens, shutting down the whole system so no fire or smoke can be spread by the fan.

CATALOG NO.	DESCRIPTION	UOM	ORDER MULTIPLE
<b>HMR-130</b>	Bi-metal Manual Reset Fire Stat	EA	1



## THERMOSTATS

### LuxPro Thermostats

LuxPro thermostats are designed to be a reliable, simple solution to in home comfort, so that everyone can enjoy the benefits and comforts of advanced temperature control. Diversitech offers a variety of LuxPro models and options to match any installation need.



675-P521U

CATALOG NO.	DESCRIPTION	UOM	ORDER MULTIPLE
675-P521U	5-2 program, 2 H/1 C, Non-Programmable	EA	1
675-P621U	5-1-1 program, 2 H/1 C, Non-Programmable	EA	1
675-P721UT	7 Day, 2 H /1 C, Non-Programmable, Touchscreen	EA	1
675-P722U	2 H /1 C, Non-Programmable	EA	1
675-PSD010BF	Digital for Heat Only, with Fan Switch	EA	1
675-PSD111	1 H /1 C, Non-Programmable, Vertical/Horizontal	EA	1
675-PSDH121	1 or 2 H/C, Non-Programmable, Vertical/Horizontal	EA	1
675-PSM30SA	Heat Only Mechanical	EA	1
675-PSM40SA	Heating & Cool Mechanical	EA	1
675-PSP722E	2 H /2 C, Programmable	EA	1

## THERMOSTAT GUARDS

### Plastic Thermostat Guards

Use to prevent tampering with thermostats. The covers are clear, allowing complete viewing of the thermostat and current settings. Furnished complete with ring and/or solid base. Includes vent holes for easy airflow across the thermostat. Lockable with universal key. Internal dimensional clearance/sizing for thermostats as noted.



585-TG1

CATALOG NO.	DESCRIPTION	T-STAT CLEARANCE	UOM	ORDER MULTIPLE
585-TG	Clear Plastic w/Two Bases	8-1/4" x 4-1/2" x 3-1/4"	EA	1
585-TG1	Clear Plastic w/Two Bases	5-3/4" x 3-1/2" x 2-3/4"	EA	1
585-TG2	Clear Plastic w/Two Bases	4-3/4" x 4-1/4" x 2-3/4"	EA	1
585-TG5	Clear Plastic w/Solid Base	3-1/2" x 3-1/4" x 2-1/4"	EA	1
585-TG6	Clear Plastic w/Two Bases	6-1/4" x 3-3/4" x 1-3/4"	EA	1
585-F336	Key for Thermostat Guard		EA	1

### Steel Thermostat Guards

Steel thermostat guards are used to prevent tampering with thermostats. The covers are steel, giving complete tamper protection of the thermostat, and physical impact protection. Great for warehouse and industrial locations. Furnished complete with ring and/or solid base as noted. Includes vent holes for easy airflow across the thermostat. Lockable with universal key. Internal dimensional clearance/sizing for thermostats as noted.



585-TG4

CATALOG NO.	DESCRIPTION	T-STAT CLEARANCE	UOM	ORDER MULTIPLE
585-TG3	Beige Steel w/Solid Base	6" x 4" x 3"	EA	1
585-TG4	Beige Steel w/Ring Base	6" x 4" x 3"	EA	1
585-TG7	Beige Steel w/Solid Base	5-1/2" x 3-1/2" x 2-3/4"	EA	1
585-TG8	Beige Steel w/Ring Base	5" x 3" x 2-3/4"	EA	1
585-TG9	Beige Steel w/Two Bases	6" x 4" x 3"	EA	1

### Cross Reference

DIVERSITECH PART NO.	BEKO PART NO.	BRAMEC PART NO.	MARS PART NO.
585-TG	BTG-UK2	13012	70220
585-TG1	BTG-RK	13016	70210
585-TG2	BTG-K	13008	70205
585-TG3	BTG-UM	13010	70223
585-TG4	BTG-UWM	13011	70224
585-TG5	BTG-EK	13004	70201
585-TG6	BTG-DK	13018	70217
585-TG7	BTG-54VL	13002	70215
585-TG8	BTG-54VLW	13001	70216

**THERMOSTAT WIRE**

**Thermostat Wire**

Class 2 thermostat wire for indoor wiring needs. Soft drawn bare copper wire, semi rigid PVC insulation and PVC overall jacket. Packaged on aluminum spool.



620-18-5

CATALOG NO.	DESCRIPTION	UOM	ORDER MULTIPLE
620-18-2	18 AWG, 2 Conductors – 500 ft. Spool	EA	4
620-18-3	18 AWG, 3 Conductors – 500 ft. Spool	EA	4
620-18-4	18 AWG, 4 Conductors – 250 ft. Spool	EA	4
620-18-5	18 AWG, 5 Conductors – 250 ft. Spool	EA	4
620-18-6	18 AWG, 6 Conductors – 250 ft. Spool	EA	4
620-18-7	18 AWG, 7 Conductors – 250 ft. Spool	EA	4
620-18-8	18 AWG, 8 Conductors – 250 ft. Spool	EA	4
620-18-9	18 AWG, 9 Conductors – 250 ft. Spool	EA	4
620-18-10	18 AWG, 10 Conductors – 250 ft. Spool	EA	4
620-18-12	18 AWG, 12 Conductors – 250 ft. Spool	EA	4
620-20-2	20 AWG, 2 Conductors – 500 ft. Spool	EA	4
620-20-3	20 AWG, 3 Conductors – 500 ft. Spool	EA	4
620-20-4	20 AWG, 4 Conductors – 250 ft. Spool	EA	4
620-20-5	20 AWG, 5 Conductors – 250 ft. Spool	EA	4
620-20-6	20 AWG, 6 Conductors – 250 ft. Spool	EA	4
620-20-7	20 AWG, 7 Conductors – 250 ft. Spool	EA	4
620-20-8	20 AWG, 8 Conductors – 250 ft. Spool	EA	4
620-20-10	20 AWG, 10 Conductors – 250 ft. Spool	EA	4

U.L. Listed. Meets Subject 13 per Article 725, 1990 NEC.

**Plenum Thermostat Wire**

The Plenum Thermostat Wire is UL Listed type CL2P NEC Article 725 and is designed for use in thermostat control applications.



620-18-5P

CATALOG NO.	DESCRIPTION	UOM	ORDER MULTIPLE
620-18-2P	18 AWG, 2 Conductors – 500 ft. Spool	EA	4
620-18-3P	18 AWG, 3 Conductors – 500 ft. Spool	EA	4
620-18-4P	18 AWG, 4 Conductors – 250 ft. Spool	EA	4
620-18-5P	18 AWG, 5 Conductors – 250 ft. Spool	EA	4
620-18-6P	18 AWG, 6 Conductors – 250 ft. Spool	EA	4
620-18-8P	18 AWG, 8 Conductors – 250 ft. Spool	EA	4

**Wire for Mini-Split Installation**

Wire and cabling specific for mini split installation power supply and control circuits.

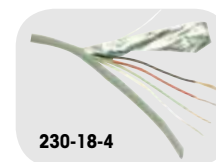

230-18-4

CATALOG NO.	DESCRIPTION	UOM	ORDER MULTIPLE
230-18-4	Stranded Shielded CL3R, 50' per roll	EA	1
230-16-2	Stranded Shielded CL3R, 50' per roll	EA	1
230-14-4	Stranded Non-Shielded CL3R, 50' per roll	EA	1
230-14-7	Stranded Non-Shielded CL3R, 50' per roll	EA	1
230-14-4S	Stranded Shielded CL3R, 50' per roll	EA	1

**STRANDED COPPER THHN WIRE**

**Stranded Copper Wire in Clear Dispenser Pack, 194°F**

This copper wire is UL listed and THHN wire. It is 19 strand copper and is 600 V as well as 90C Stranded.



W142

CATALOG NO.	DESCRIPTION	UOM	ORDER MULTIPLE
W801	08 Gauge, 10 ft., Black	EA	1
W802	08 Gauge, 10 ft., Red	EA	1
W803	08 Gauge, 10 ft., Green	EA	1
W804	08 Gauge, 10 ft., Blue	EA	1
W805	08 Gauge, 10 ft., White	EA	1
W101	10 Gauge, 10 ft., Black	EA	1
W102	10 Gauge, 10 ft., Red	EA	1
W103	10 Gauge, 10 ft., Green	EA	1
W104	10 Gauge, 10 ft., Blue	EA	1
W105	10 Gauge, 10 ft., White	EA	1
W121	12 Gauge, 15 ft., Black	EA	1
W122	12 Gauge, 15 ft., Red	EA	1
W123	12 Gauge, 15 ft., Green	EA	1
W124	12 Gauge, 15 ft., Blue	EA	1
W125	12 Gauge, 15 ft., White	EA	1
W141	14 Gauge, 20 ft., Black	EA	1
W142	14 Gauge, 20 ft., Red	EA	1
W143	14 Gauge, 20 ft., Green	EA	1
W144	14 Gauge, 20 ft., Blue	EA	1
W145	14 Gauge, 20 ft., White	EA	1

**Stranded Copper Wire on Spool**

This copper wire is UL listed and THHN wire. It is 19 strand copper and is 600 V as well as 90C Stranded. This comes 100 ft. per spool.



W803-100

CATALOG NO.	DESCRIPTION	UOM	ORDER MULTIPLE
W801-100	08 Gauge, 100 ft. Spool, Black	EA	1
W802-100	08 Gauge, 100 ft. Spool, Red	EA	1
W803-100	08 Gauge, 100 ft. Spool, Green	EA	1
W804-100	08 Gauge, 100 ft. Spool, Blue	EA	1
W805-100	08 Gauge, 100 ft. Spool, White	EA	1
W101-100	10 Gauge, 100 ft. Spool, Black	EA	1
W102-100	10 Gauge, 100 ft. Spool, Red	EA	1
W103-100	10 Gauge, 100 ft. Spool, Green	EA	1
W104-100	10 Gauge, 100 ft. Spool, Blue	EA	1
W105-100	10 Gauge, 100 ft. Spool, White	EA	1
W121-100	12 Gauge, 100 ft. Spool, Black	EA	1
W122-100	12 Gauge, 100 ft. Spool, Red	EA	1
W123-100	12 Gauge, 100 ft. Spool, Green	EA	1
W124-100	12 Gauge, 100 ft. Spool, Blue	EA	1
W125-100	12 Gauge, 100 ft. Spool, White	EA	1
W141-100	14 Gauge, 100 ft. Spool, Black	EA	1
W142-100	14 Gauge, 100 ft. Spool, Red	EA	1
W143-100	14 Gauge, 100 ft. Spool, Green	EA	1
W144-100	14 Gauge, 100 ft. Spool, Blue	EA	1
W145-100	14 Gauge, 100 ft. Spool, White	EA	1

**STRANDED COPPER THHN WIRE** cont'd

**Stranded Copper Wire on Spool**

This copper wire is UL listed and THHN wire. It is 19 strand copper and is 600 V as well as 90C Stranded. This comes 50 ft. per spool.



CATALOG NO.	DESCRIPTION	UOM	ORDER MULTIPLE
W801-50	08 Gauge, 50 ft. Spool, Black	EA	1
W802-50	08 Gauge, 50 ft. Spool, Red	EA	1
W803-50	08 Gauge, 50 ft. Spool, Green	EA	1
W804-50	08 Gauge, 50 ft. Spool, Blue	EA	1
W805-50	08 Gauge, 50 ft. Spool, White	EA	1
W101-50	10 Gauge, 50 ft. Spool, Black	EA	1
W102-50	10 Gauge, 50 ft. Spool, Red	EA	1
W103-50	10 Gauge, 50 ft. Spool, Green	EA	1
W104-50	10 Gauge, 50 ft. Spool, Blue	EA	1
W105-50	10 Gauge, 50 ft. Spool, White	EA	1
W121-50	12 Gauge, 50 ft. Spool, Black	EA	1
W122-50	12 Gauge, 50 ft. Spool, Red	EA	1
W123-50	12 Gauge, 50 ft. Spool, Green	EA	1
W124-50	12 Gauge, 50 ft. Spool, Blue	EA	1
W125-50	12 Gauge, 50 ft. Spool, White	EA	1
W141-50	14 Gauge, 50 ft. Spool, Black	EA	1
W142-50	14 Gauge, 50 ft. Spool, Red	EA	1
W143-50	14 Gauge, 50 ft. Spool, Green	EA	1
W144-50	14 Gauge, 50 ft. Spool, Blue	EA	1
W145-50	14 Gauge, 50 ft. Spool, White	EA	1

**High Temperature Wire, 400°F (204°C), 600 V.**

7 strand tin coated copper wire with silicone rubber insulation protected by a braided fiberglass jacket. Use on the front of all gas furnaces with spark ignition because of flame roll out on start up. Also on all power feeds to electric strip and duct heaters. Also used on all heat producing food preparation equipment.



CATALOG NO.	DESCRIPTION	UOM	ORDER MULTIPLE
WHT20	14 gauge, 10 ft. black, 10 ft. white	EA	1
WHTB14-50	14 gauge, black, 50 ft.	EA	1
WHTR14-50	14 gauge, red, 50 ft.	EA	1
WHTW14-50	14 gauge, white, 50 ft.	EA	1
WHTB12-20	12 gauge, black, 20 ft.	EA	1
WHTB12-50	12 gauge, black, 50 ft.	EA	1
WHTB10-20	10 gauge, black, 20 ft.	EA	1
WHTB10-50	10 gauge, black, 50 ft.	EA	1

**WIRE CONNECTORS**

**Wire Connectors—Screw On, U.L. Listed, C.S.A Approved**

Color coded connectors make quick, secure connections for positive continuity. High dielectric thermoplastic shell resists chemical action from hydrocarbons, dilute acid or alkaline solutions. Deep skirt design prevents exposure of bare wire.



CATALOG NO.	DESCRIPTION	UOM	ORDER MULTIPLE
623-001	Gray Screw-On – Size 71B, #22 to #16 AWG, 300V Max., pack of 100	PK	1
623-002	Blue Screw-On – Size 72B, #22 to #16 AWG, 300V Max., pack of 100	PK	1
623-003	Orange Screw-On – Size 73B, #22 to #14 AWG, 600V Max., pack of 100	PK	1
623-004	Yellow Screw-On – Size 74B, #18 to #10 AWG, 600V Max., pack of 100	PK	1
623-005	Red Screw-On – Size 76B, #18 to #10 AWG, 600V Max., pack of 100	PK	1
623-MIX	Wire connector assortment, Pack of 570	PK	1

U.L. Listed. CSA Approved.

**Wire Connectors—Winged, U.L. Listed, C.S.A Approved**

Wings give surer grip; offset center design provides great twisting leverage. Expandable square-wire spring instantly adjusts to shape and size to create a strong, vibration-resistant connection. Same tough shell as screw-on type.



CATALOG NO.	DESCRIPTION	UOM	ORDER MULTIPLE
623-000	Lg. Gray Winged – Size 78B, #14 to #8 AWG, 600V Max., pack of 50	PK	1
623-006	Yellow Winged – Size 84, #22 to #10 AWG, 600V Max., pack of 100	PK	1
623-007	Red Winged – Size 86, #18 to #10 AWG, 600V Max., pack of 100	PK	1
623-008	Blue Winged – Size 89, #10 to #6, 600V Max., pack of 50	PK	1

U.L. Listed. C.S.A. Approved.

**WIRE CONNECTORS cont'd**

**Wire Connectors—Screw On, U.L. Listed, C.S.A Approved**

Color coded connectors make quick, secure connections for positive continuity. High dielectric thermoplastic shell resists chemical action from hydrocarbons, dilute acid or alkaline solutions. Deep skirt design prevents exposure of bare wire. New handy carry handle and grip bottle. U.L. Listed. C.S.A. Approved.



CATALOG NO.	DESCRIPTION	UOM	ORDER MULTIPLE
<b>623-012</b>	Blue Screw-On – Size 72B, #22 to #16 AWG, 300V Max., pack of 600	PK	1
<b>623-013</b>	Orange Screw-On – Size 73B, #22 to #14 AWG, 600V Max., pack of 300	PK	1
<b>623-014</b>	Yellow Screw-On – Size 74B, #18 to #10 AWG, 600V Max., pack of 200	PK	1

U.L. Listed. CSA Approved.

**Porcelain Wire Connectors**

Porcelain Wire Connectors are used in high temperature applications such as appliances.



CATALOG NO.	DESCRIPTION	AWG	UOM	ORDER MULTIPLE
<b>CPN1</b>	Porcelain – Small, pack of 15	22-16, 2 Strand Wire	PK	1
<b>CPN1C</b>	Porcelain – Small, pack of 100	22-16, 2 Strand Wire	PK	1
<b>CPN2</b>	Porcelain – Medium, pack of 10	18-14, 2 Strand Wire	PK	1
<b>CPN2C</b>	Porcelain – Medium, pack of 100	18-14, 2 Strand Wire	PK	1
<b>CPN3</b>	Porcelain – Large, pack of 10	18-14, 3 Strand Wire	PK	1
<b>CPN3C</b>	Porcelain – Large, pack of 100	18-14, 3 Strand Wire	PK	1

**Wire Connectors—Contractor Packs, U.L. Listed, C.S.A Approved**

These connectors have a high dielectric thermoplastic shell. These are UL listed and CSA approved. This product is great for making quick and secure connections.



CATALOG NO.	DESCRIPTION	UOM	ORDER MULTIPLE
<b>C222</b>	Closed End Connectors 22-14 W, pack of 18	PK	1
<b>C222C</b>	Closed End Connectors 22-14 W, pack of 100	PK	1
<b>C223</b>	Closed End Connectors 18-10 W, pack of 15	PK	1
<b>C223C</b>	Closed End Connectors 18-10 W, pack of 100	PK	1
<b>C241</b>	Blue Wire Connectors 22-16 W, pack of 20	PK	1
<b>C243</b>	Orange Wire Connectors 22-14 W, pack of 15	PK	1
<b>C245</b>	Yellow Wire Connectors 18-10 W, pack of 13	PK	1
<b>C247</b>	Red Wire Connectors 18-10 W, pack of 10	PK	1
<b>C312</b>	Yellow Winged Wire Connectors, pack of 13	PK	1
<b>C312L</b>	Yellow Winged Wire Connectors, pack of 50	PK	1
<b>C512</b>	Red Winged Wire Connectors, pack of 10	PK	1
<b>C512L</b>	Red Winged Wire Connectors, pack of 50	PK	1

U.L. Listed. CSA Approved.

**WIRE/CABLE TIES, MOUNTS, CLAMPS**

**Cable Tie Assortment Pack**

6.6 nylon, the heavy duty duct straps feature smooth insertion, and a locking mechanism that gives ductwork a firm hold. Accommodates 7 to 15 inch duct. Tensioning tool for 32"+ allows operator to adjust strap to any desired tension.



CATALOG NO.	DESCRIPTION	UOM	ORDER MULTIPLE
<b>7-711</b>	Natural Cable Tie Assortment – 7" and 11", pack of 150	PK	25
<b>7-711-B</b>	Black Cable Tie Assortment – 7" and 11", pack of 150	PK	25
<b>7-5811</b>	Natural Cable Tie Assortment – 5", 8", and 11", pack of 450	PK	30
<b>7-5811-B</b>	Black Cable Tie Assortment – 5", 8", and 11", pack of 450	PK	30

**Heavy Duty Cable Ties**

6.6 nylon, the heavy duty duct straps feature smooth insertion, and a locking mechanism that gives ductwork a firm hold. Accommodates 7 to 15 inch duct. Tensioning tool for 32"+ allows operator to adjust strap to any desired tension.

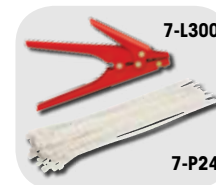

CATALOG NO.	DESCRIPTION	UOM	ORDER MULTIPLE
<b>7-P24</b>	24" Long – Fits up to 6" Duct – 175 lb. Tensile	EA	50
<b>7-P36</b>	36" Long – Fits up to 10" Duct – 175 lb. Tensile	EA	50
<b>7-P36B</b>	36" Long – Black – Fits up to 10" Duct – 175 lb. Tensile	EA	50
<b>7-P48</b>	48" Long – Fits up to 14" Duct – 175 lb. Tensile	EA	50
<b>7-P48B</b>	48" Long – Black – Fits up to 14" Duct – 175 lb. Tensile	EA	50
<b>7-L300</b>	Tensioning Tool for 120-175 lb. Ties	EA	1

**WIRE/CABLE TIES, MOUNTS, CLAMPS cont'd**

**White Nylon Ties with Mounting Hole**

These wire ties are perfect for securing wires. You can choose from an assortment of sizes.

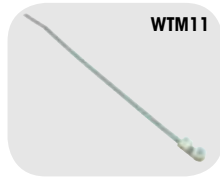

CATALOG NO.	DESCRIPTION	TENSILE STRENGTH	UOM	ORDER MULTIPLE
WTM05	White Wire Ties with Mounting Hole – 5" Nylon, pack of 13	18	PK	1
WTM05C	White Wire Ties with Mounting Hole – 5" Nylon, pack of 100	18	PK	1
WTM07	White Wire Ties with Mounting Hole – 7" Nylon, pack of 11	50	PK	1
WTM07C	White Wire Ties with Mounting Hole – 7" Nylon, pack of 100	50	PK	1
WTM11	White Wire Ties with Mounting Hole – 11" Nylon, pack of 6	50	PK	1
WTM11C	White Wire Ties with Mounting Hole – 11" Nylon, pack of 100	50	PK	1
WTM14	White Wire Ties with Mounting Hole – 14" Nylon, pack of 5	50	PK	1
WTM14C	White Wire Ties with Mounting Hole – 14" Nylon, pack of 100	50	PK	1

**Black Nylon Ties with Mounting Hole**

These wire ties are perfect for securing wires. You can choose from an assortment of sizes.



CATALOG NO.	DESCRIPTION	TENSILE STRENGTH	ORDER UOM	MULTIPLE
WTMB05	Black Wire Ties with Mounting Hole – 5" Nylon, pack of 12	18	PK	1
WTMB05C	Black Wire Ties with Mounting Hole – 5" Nylon, pack of 100	18	PK	1
WTMB07	Black Wire Ties with Mounting Hole – 7" Nylon, pack of 10	50	PK	1
WTMB07C	Black Wire Ties with Mounting Hole – 7" Nylon, pack of 100	50	PK	1
WTMB11	Black Wire Ties with Mounting Hole – 11" Nylon, pack of 6	50	PK	1
WTMB11C	Black Wire Ties with Mounting Hole – 11" Nylon, pack of 100	50	PK	1
WTMB14	Black Wire Ties with Mounting Hole – 14" Nylon, pack of 5	50	PK	1
WTMB14C	Black Wire Ties with Mounting Hole – 14" Nylon, pack of 100	50	PK	1

**Wire and Cable Clamps – Nylon**

These wire ties are perfect for securing wires. You can choose from an assortment of diameter sizes.



CATALOG NO.	DESCRIPTION	UOM	ORDER MULTIPLE
WC02	Wire and Cable Clamps – 1/8" Diameter, pack of 40	PK	1
WC03	Wire and Cable Clamps – 3/16" Diameter, pack of 40	PK	1
WC04	Wire and Cable Clamps – 1/4" Diameter, pack of 35	PK	1
WC05	Wire and Cable Clamps – 5/16" Diameter, pack of 35	PK	1
WC06	Wire and Cable Clamps – 3/8" Diameter, pack of 30	PK	1
WC07	Wire and Cable Clamps – 7/16" Diameter, pack of 30	PK	1
WC08	Wire and Cable Clamps – 1/2" Diameter, pack of 25	PK	1
WC09	Wire and Cable Clamps – 9/16" Diameter, pack of 20	PK	1
WC10	Wire and Cable Clamps – 5/8" Diameter, pack of 20	PK	1
WC12	Wire and Cable Clamps – 3/4" Diameter, pack of 15	PK	1
WC14	Wire and Cable Clamps – 7/8" Diameter, pack of 15	PK	1
WC16	Wire and Cable Clamps – 1" Diameter, pack of 14	PK	1
WCA1	Wire and Cable Clamps Assortment – 1/8" to 1", pack of 26	PK	1

All above sizes are available in 100 packs. Add "C" to the end of the part number.

**White Nylon Wire Ties**

These wire ties are perfect for securing wires. You can choose from an assortment of sizes.

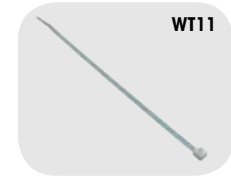

CATALOG NO.	DESCRIPTION	TENSILE STRENGTH	UOM	ORDER MULTIPLE
WT04	White Wire Ties – 4" Nylon, pack of 40	18	PK	1
WT04C	White Wire Ties – 4" Nylon, pack of 100	18	PK	1
WT05	White Wire Ties – 5" Nylon, pack of 35	18	PK	1
WT05C	White Wire Ties – 5" Nylon, pack of 100	18	PK	1
WT07	White Wire Ties – 7" Nylon, pack of 30	50	PK	1
WT07C	White Wire Ties – 7" Nylon, pack of 100	50	PK	1
WT11	White Wire Ties – 11" Nylon, pack of 15	50	PK	1
WT11C	White Wire Ties – 11" Nylon, pack of 100	50	PK	1
WT15	White Wire Ties – 15" Nylon, pack of 12	50	PK	1
WT15C	White Wire Ties – 15" Nylon, pack of 100	50	PK	1
WTA1	White Wire Ties – Assorted 4", 7", and 11" Nylon, pack of 30		PK	1

**Black Nylon Wire Ties**

These wire ties are perfect for securing wires. You can choose from an assortment of sizes. Ultraviolet resistant for outdoor use.

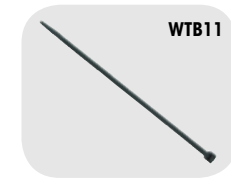

CATALOG NO.	DESCRIPTION	TENSILE STRENGTH	UOM	ORDER MULTIPLE
WTB05	Black Wire Ties – 5" Nylon, pack of 35	18	PK	1
WTB05C	Black Wire Ties – 5" Nylon, pack of 100	18	PK	1
WTB07	Black Wire Ties – 7" Nylon, pack of 30	50	PK	1
WTB07C	Black Wire Ties – 7" Nylon, pack of 100	50	PK	1
WTB07M	Black Wire Ties – 7" Nylon, pack of 1000	50	PK	1
WTB11	Black Wire Ties – 11" Nylon, pack of 15	50	PK	1
WTB11C	Black Wire Ties – 11" Nylon, pack of 100	50	PK	1
WTB11CR	Black Wire Ties, Releasable – 11" Nylon, pack of 100	50	PK	1
WTB11D	Black Wire Ties – 11" Nylon, pack of 500	50	PK	1
WTB11M	Black Wire Ties – 11" Nylon, pack of 1000	50	PK	1
WTB15B	Black Wire Ties – 14" Nylon, pack of	50	PK	1
WTB15	Black Wire Ties – 15" Nylon, pack of 12	50	PK	1
WTB15C	Black Wire Ties – 15" Nylon, pack of 100	50	PK	1

**Wire Tie Mounts**

These mounts are use for mounting wires in electrical work.



CATALOG NO.	DESCRIPTION	UOM	ORDER MULTIPLE
WTM1	White Wire Tie Mounts – Adhesive Back, pack of 4	PK	1
WTM1C	White Wire Tie Mounts – Adhesive Back, pack of 100	PK	1
WTM2	White Wire Tie Mounts – #8 Screw, pack of 7	PK	1
WTM2C	White Wire Tie Mounts – #8 Screw, pack of 100	PK	1

# The Perfect Pad for Every Project

**E LITE**  
DIVERSITECH

**HEF-T-PAD**  
DIVERSITECH

**THE BLACK PAD**  
DIVERSITECH

**ULTRALITE**  
DIVERSITECH

**CLADLITE**  
DIVERSITECH

**E Lite**<sup>®</sup>

**UltraLite**<sup>®</sup>

**CladLite**<sup>®</sup>

**Hef-T-Pad**<sup>™</sup>

**THE Black Pad**<sup>®</sup>

With DiversiTech's complete lineup of durable equipment pads, you're sure to find the right one for any project. From our lightweight Hef-T-Pads to sturdy concrete CladLites we offer the best selection of materials and sizes so your customers get what they need. Check out the complete pad and product offering at [www.diversitech.com](http://www.diversitech.com)

**DIVERSITECH**



# TOOLS

- Allen Wrenches ..... 161
- Brushes..... 161-163
- Calipers ..... 164
- Channellock® Products ..... 164
- Clipboards..... 164
- Electrical Supplies ..... 165
- Fin Tools..... 165-166
- Flashlights and Lanterns By Rayovac® ..... 166
- Flashlights By Mag-Lite® ..... 167
- Gauges ..... 168
- Hobby and Cutting Knives ..... 168
- HVAC Airflow Instruments ..... 168
- Manometers, Pressure..... 169
- Measuring Tapes, Staples and Staple Guns ..... 169
- Meters, Detectors, Alarms ..... 169-170
- Miscellaneous Tools..... 170-171
- Monitors..... 171
- Nut Setters ..... 172
- Refractometers ..... 172
- Rehvac Nitrogen Purging Equipment..... 160
- Rehvac Refillable Gas Cylinders..... 160
- Retrieving Tool/Mini-Lights..... 172
- Saws and Saw Blades..... 173
- Scales..... 173
- Screwdrivers, Driver Sets ..... 173-174
- Snips, Notchers, Crimpers, Seamers..... 174
- Straps, Truck Rope ..... 175
- Test Leads ..... 176
- Testers ..... 176
- Thermometers/Probes ..... 177-179
- Tool Bags ..... 179
- Tube Working Tools ..... 179-180
- Welding Torches, Supplies ..... 180



**REHVAC NITROGEN PURGING EQUIPMENT**

**Regulators**

Rehvac nitrogen and CO<sub>2</sub> regulators feature a machined brass piston with internal bleed-down safety. This design makes the Rehvac regulator long lasting and reliable.



**CT-475M**

CATALOG NO.	DESCRIPTION	UOM	ORDER MULTIPLE
<b>CA-252C</b>	Rehvac Adjustable Regulator, 0-250psi	EA	1
<b>CT-475M</b>	Regulator, N/CO <sub>2</sub> – 0-475 psi	EA	1
<b>GT-750</b>	Rehvac Nitrogen Regulator 0-750psi	EA	1

**Hoses**

Rehvac hoses are designed specifically for air, nitrogen, or CO<sub>2</sub> service. Featuring a 600psi working pressure and a 2200psi burst pressure, Rehvac hoses are abrasion resistant and long lasting.



**CW-30**

CATALOG NO.	DESCRIPTION	UOM	ORDER MULTIPLE
<b>CW-30</b>	Rehvac 30" Whip Hose	EA	1

**Flowmeters**

The Rehvac Nitrogen Purge Flow-meter is the perfect tool for purging the line-set before brazing. This flowmeter attaches to the 1/4" flare fitting on a regulator and delivers a metered flow. The flow rate can be increased for the purge process and restricted for the brazing process. Maximum operating pressure is 50 psi. Flowmeter works well with our CT-475M Regulator.



**GAU225-PURGE**

CATALOG NO.	DESCRIPTION	UOM	ORDER MULTIPLE
<b>GAU225-PURGE</b>	Rehvac Nitrogen Purge Flowmeter	EA	1

**Gauges**

Rehvac replacement gauges are reliable and easy to read.



**GA-06**

CATALOG NO.	DESCRIPTION	UOM	ORDER MULTIPLE
<b>GA-06</b>	Rehvac 600psi Low Pressure Replacement Gauge	EA	1
<b>GA-30</b>	Rehvac 3000psi High Pressure Replacement Gauge	EA	1

**REHVAC REFILLABLE GAS CYLINDERS**

**Nitrogen Cylinders**

Rehvac aluminum nitrogen cylinders from DiversiTech are commonly used in the HVAC industry for line cleaning and purging, pressure testing and braze purging. Made in the USA.



**N20-SD**

CATALOG NO.	DESCRIPTION	UOM	ORDER MULTIPLE
<b>N20-SD</b>	Rehvac Nitrogen Cylinder 57 cu ft	EA	1

**CO<sub>2</sub> Cylinders**

Rehvac aluminum CO<sub>2</sub> cylinders from DiversiTech are commonly used in the HVAC industry for condensate line cleaning. Made in the USA.



**C10**

CATALOG NO.	DESCRIPTION	UOM	ORDER MULTIPLE
<b>C10</b>	Rehvac 10# Aluminum Cylinder	EA	1
<b>C1-2-6</b>	Rehvac 1.2# Cylinder	EA	1
<b>C20</b>	Rehvac Nitrogen Purge Flowmeter	EA	1
<b>C20-D</b>	Rehvac 20# Cylinder with Siphon Tube	EA	1
<b>C2-5</b>	Rehvac Cylinder, 2.5#	EA	1
<b>C2-5S</b>	Rehvac 2.5# Cylinder with Straight Valve	EA	1
<b>C5</b>	Rehvac 5# Aluminum Cylinder	EA	1

## ALLEN WRENCHES

### Allen Wrenches – Long Arm

Most needed combination of Allen Wrenches packaged in clearly marked vinyl pouches.



CATALOG NO.	DESCRIPTION	UOM	ORDER MULTIPLE
<b>AW-712</b>	7 Keys, 12" long arm series: 5/64", 3/32", 1/8", 5/32", 3/16", 7/32", 1/4"	EA	1
<b>AW-96</b>	9 Keys, 6" long arm series: 5/64", 3/32", 1/8", 5/32", 3/16", 7/32", 1/4", 5/16", 3/8"	EA	1

### Allen Duracast™ Fold Ups

Unique "double foldout" design. This convenient pocket wrench set opens from both the top and bottom for fast, easy access to each and every bit. Instead of unfolding the top wrenches to get at the wrenches underneath, just turn the FOLD UP over. Specially contoured handle, so you'll never cut your hands or snag clothing.



CATALOG NO.	DESCRIPTION	UOM	ORDER MULTIPLE
<b>AWZ-2500</b>	3-1/2" Handle, 9 Bits .050", 1/16", 5/64", 3/32", 7/64", 1/8", 9/64", 5/32", 3/16"	EA	1
<b>AWZ-3000</b>	4-1/4" Handle, 9 Bits 5/64", 3/32", 7/64", 1/8", 9/64", 5/32", 3/16", 7/32", 1/4"	EA	1

### Allen Wrenches

The finest quality wrenches available anywhere.



CATALOG NO.	DESCRIPTION	UOM	ORDER MULTIPLE
<b>AW-8</b>	3" Handle, 8 Bits, Standard Fold-Ups .050", 1/16", 5/64", 3/32", 7/64", 1/8", 9/64", 5/32"	EA	1
<b>AW-9</b>	4" Handle, 9 Bits, Standard Fold-Ups 5/64", 3/32", 7/64", 1/8", 9/64", 5/32", 3/16", 7/32", 1/4"	EA	1
<b>AWL-5</b>	5-1/4" Handle, 5 Bits, Long Arm Fold-Ups 3/16", 7/32", 1/4", 5/16", 3/8"	EA	1
<b>AWL-9</b>	6-1/4" Handle, 9 Bits, Long Arm Fold-Ups 5/64", 3/32", 7/64", 1/8", 9/64", 5/32", 3/16", 7/32", 1/4"	EA	1

### Allen Wrenches – Individual Sizes

These Allen Wrenches are sold in individual sizes. These are great for specific projects.



CATALOG NO.	DESCRIPTION	UOM	ORDER MULTIPLE
<b>AW-712-10</b>	Allen Wrench 12" x 5/32"	EA	25
<b>AW-712-8</b>	Allen Wrench 12" x 1/8"	EA	25
<b>AW-96-10</b>	Allen Wrench 6" x 5/32"	EA	25
<b>AW-96-8</b>	Allen Wrench 6" x 1/8"	EA	25

## BRUSHES

### Chip Brushes

100% pure bristle, wood handle. Poly sleeve over bristles. Inexpensive (use once and throw away). Excellent for applying duct adhesive.



CATALOG NO.	DESCRIPTION	UOM	ORDER MULTIPLE
<b>B-501</b>	Chip Brush – 1"	EA	36
<b>B-502</b>	Chip Brush – 1-1/2"	EA	36
<b>B-503</b>	Chip Brush – 2"	EA	24
<b>B-504</b>	Chip Brush – 2-1/2"	EA	12
<b>B-505</b>	Chip Brush – 3"	EA	12

### Welder's Brush

Stainless steel bristles used for cleaning all metals. Great for cleaning aluminum prior to soldering.

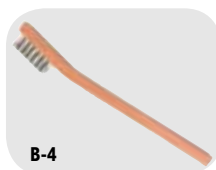

CATALOG NO.	DESCRIPTION	UOM	ORDER MULTIPLE
<b>B-4</b>	Welder's Brush	EA	12

### Tin Handle Acid Brushes

Manufactured with electrolyte tin plate and filled with 100% pure stiff horsehair, tied with a steel staple. This combination gives lasting qualities when used with heat and acids or other cleaning agents.



CATALOG NO.	DESCRIPTION	UOM	ORDER MULTIPLE
<b>B-1</b>	Tin Handle Acid Brush 3/8"	EA	144
<b>B-2</b>	Tin Handle Acid Brush 1/2"	EA	144

### Refrigerator Coil Brush

Clean refrigerator coils, fan blades and areas under and behind appliances. 27-1/2" in length with 11-3/4" brush length. Bristles are 3/4" on the end tapering to 1-1/2" toward the handle.



CATALOG NO.	DESCRIPTION	UOM	ORDER MULTIPLE
<b>B-27</b>	Refrigerator Coil Brush	EA	1

**BRUSHES** cont'd

**Wood Handle Dope Brush**

These dope brushes are made of select horsehair bristles secured tightly in a metal ferrule.



CATALOG NO.	DESCRIPTION	UOM	ORDER MULTIPLE
542-10007	Wood Handle Dope Brush – 3/4" x 7"	EA	36

**Duct Cleaning Brush**

These brushes are made of black fiber bristles twisted in wire. They are 1 1/8in. diameter by 7in. brush x 48in. overall length. These are idea for cleaning hard to reach areas in duct work.

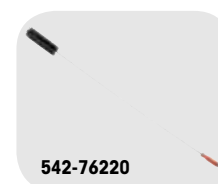

CATALOG NO.	DESCRIPTION	UOM	ORDER MULTIPLE
542-76220	Duct Cleaning Brush	EA	1

**Parts Cleaning Brush**

The heavy duty black polypropylene bristles are secured in a strong plastic handle.



CATALOG NO.	DESCRIPTION	UOM	ORDER MULTIPLE
542-25015	Parts Cleaning Brush	EA	12

**Outside Tube Cleaning Brushes**

A tough molded plastic holder allows for a comfortable sure grip. The brush has high carbon steel bristles and comes 6 to a box.

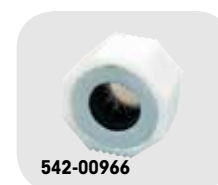

CATALOG NO.	DESCRIPTION	UOM	ORDER MULTIPLE
542-00966	Outside Tube Cleaning Brush – 1/2" ID (5/8" OD)	EA	6
542-00968	Outside Tube Cleaning Brush – 3/4" ID (7/8" OD)	EA	6

**2-in-1 Copper Tube Cleaning Brush**

Easy to hold combination tool that really works. One end cleans the fitting. The other cleans the tube.



CATALOG NO.	DESCRIPTION	UOM	ORDER MULTIPLE
B-996	2-in-1 Copper Tube Cleaning Brush – 1/2" ID (5/8" OD)	EA	1
B-998	2-in-1 Copper Tube Cleaning Brush – 3/4" ID (7/8" OD)	EA	1

**Copper Tube Fitting Brushes**

Highest quality brushes to clean fittings faster, easier and more safely. Made with strong, resilient, rustproof stainless steel bristles secured in a 4-ply wire with easy-to-grip plastic handle. Economy models feature same quality stainless steel, but secured in 2-ply wire.



CATALOG NO.	DESCRIPTION	UOM	ORDER MULTIPLE
B-124	Copper Tube Fitting Brush – Economy 1/4" O.D., 9/32" Brush Dia.	EA	6
B-125	Copper Tube Fitting Brush – Economy 3/8" O.D., 13/32" Brush Dia.	EA	6
B-126	Copper Tube Fitting Brush – Economy 1/2" O.D., 17/32" Brush Dia.	EA	6
B-127	Copper Tube Fitting Brush – Economy 5/8" O.D., 1 1/16" Brush Dia.	EA	6
B-128	Copper Tube Fitting Brush – Economy 3/4" O.D., 1 3/16" Brush Dia.	EA	6
B-129	Copper Tube Fitting Brush – Economy 7/8" O.D., 1 5/16" Brush Dia.	EA	6
B-130	Copper Tube Fitting Brush – Economy 1" O.D., 1-1/8" Brush Dia.	EA	6
B-131	Copper Tube Fitting Brush – Economy 1-1/8" O.D., 1-1/4" Brush Dia.	EA	6
B-132	Copper Tube Fitting Brush – Economy 1-3/8" O.D., 1-1/2" Brush Dia.	EA	6
B-924	Copper Tube Fitting Brush – 1/4" O.D., 9/32" Brush Dia.	EA	1
B-925	Copper Tube Fitting Brush – 3/8" O.D., 13/32" Brush Dia.	EA	1
B-926	Copper Tube Fitting Brush – 1/2" O.D., 17/32" Brush Dia.	EA	1
B-927	Copper Tube Fitting Brush – 5/8" O.D., 1 1/16" Brush Dia.	EA	1
B-928	Copper Tube Fitting Brush – 3/4" O.D., 1 3/16" Brush Dia.	EA	1
B-929	Copper Tube Fitting Brush – 7/8" O.D., 1 5/16" Brush Dia.	EA	1
B-930	Copper Tube Fitting Brush – 1" O.D., 1-1/8" Brush Dia.	EA	1
B-931	Copper Tube Fitting Brush – 1-1/8" O.D., 1-1/4" Brush Dia.	EA	1
B-932	Copper Tube Fitting Brush – 1-3/8" O.D., 1-1/2" Brush Dia.	EA	1
B-934	Copper Tube Fitting Brush – 1-5/8" O.D., 1-3/4" Brush Dia.	EA	1
B-935	Copper Tube Fitting Brush – 2-1/8" O.D., 2-1/4" Brush Dia.	EA	1

**BRUSHES cont'd**

**Carbon Steel Curved Handle Scratch Brush**

Carbon Steel Curved Handle Scratch Brushes are used for general purpose cleaning.



**B-10**

CATALOG NO.	DESCRIPTION	UOM	ORDER MULTIPLE
<b>B-10</b>	Carbon Steel Curved Handle Scratch Brush	EA	1

**Condenser/Heat Exchanger Brushes**

Ideal for cleaning mineral deposits from inside metal tubes. Especially recommended for use with power tools, although handle for manual use is available.

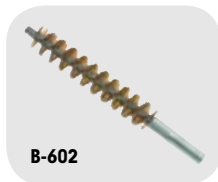

**B-602**

CATALOG NO.	DESCRIPTION	UOM	ORDER MULTIPLE
<b>B-602</b>	Condenser/Heat Exchanger Brush – 1/4" Brass 8-32 Female	EA	1
<b>B-604</b>	Condenser/Heat Exchanger Brush – 3/8" Brass 12-24 Female	EA	1
<b>B-607</b>	Condenser/Heat Exchanger Brush – 7/16" Brass 12-24 Female	EA	1
<b>B-610</b>	Condenser/Heat Exchanger Brush – 1/2" Brass 12-24 Female	EA	1
<b>B-613</b>	Condenser/Heat Exchanger Brush – 9/16" Brass 12-24 Female	EA	1
<b>B-616</b>	Condenser/Heat Exchanger Brush – 5/8" Brass 12-24 Female	EA	1
<b>B-619</b>	Condenser/Heat Exchanger Brush – 11/16" Brass 12-24 Female	EA	1
<b>B-622</b>	Condenser/Heat Exchanger Brush – 3/4" Brass 12-24 Female	EA	1
<b>B-628</b>	Condenser/Heat Exchanger Brush – 7/8" Brass 12-24 Female	EA	1
<b>B-633</b>	Condenser/Heat Exchanger Brush – 1" Brass 12-24 Female	EA	1
<b>B-702</b>	Condenser/Heat Exchanger Brush – 1/4" Nylon 8-32 Female	EA	1
<b>B-704</b>	Condenser/Heat Exchanger Brush – 3/8" Nylon 12-24 Female	EA	1
<b>B-707</b>	Condenser/Heat Exchanger Brush – 7/16" Nylon 12-24 Female	EA	1
<b>B-710</b>	Condenser/Heat Exchanger Brush – 1/2" Nylon 12-24 Female	EA	1
<b>B-713</b>	Condenser/Heat Exchanger Brush – 9/16" Nylon 12-24 Female	EA	1
<b>B-716</b>	Condenser/Heat Exchanger Brush – 5/8" Nylon 12-24 Female	EA	1
<b>B-719</b>	Condenser/Heat Exchanger Brush – 11/16" Nylon 12-24 Female	EA	1
<b>B-722</b>	Condenser/Heat Exchanger Brush – 3/4" Nylon 12-24 Female	EA	1
<b>B-728</b>	Condenser/Heat Exchanger Brush – 7/8" Nylon 12-24 Female	EA	1
<b>B-733</b>	Condenser/Heat Exchanger Brush – 1" Nylon 12-24 Female	EA	1
<b>B-802</b>	Condenser/Heat Exchanger Brush – 1/4" Stainless 8-32 Female	EA	1
<b>B-804</b>	Condenser/Heat Exchanger Brush – 3/8" Stainless 12-24 Female	EA	1
<b>B-807</b>	Condenser/Heat Exchanger Brush – 7/16" Stainless 12-24 Female	EA	1
<b>B-810</b>	Condenser/Heat Exchanger Brush – 1/2" Stainless 12-24 Female	EA	1
<b>B-813</b>	Condenser/Heat Exchanger Brush – 9/16" Stainless 12-24 Female	EA	1
<b>B-816</b>	Condenser/Heat Exchanger Brush – 5/8" Stainless 12-24 Female	EA	1
<b>B-819</b>	Condenser/Heat Exchanger Brush – 11/16" Stainless 12-24 Female	EA	1
<b>B-822</b>	Condenser/Heat Exchanger Brush – 3/4" Stainless 12-24 Female	EA	1

**Extension Rods for Condenser Tube Brushes**

Aluminum rods can be threaded into each other to make an endless length with these extension rods.



**BE-24**

CATALOG NO.	DESCRIPTION	UOM	ORDER MULTIPLE
<b>BE-24</b>	24" Rods w/male thread one end, female other 12-24 thread size	EA	3
<b>BE-36</b>	36" Rods w/male thread one end, female other 12-24 thread size	EA	3
<b>BE-48</b>	48" Rods for 1/4" brushes only 8-32 thread size	EA	3
<b>BH-1</b>	Handgrip – 4" long threads into rods	EA	1

**Fin Whisk**

A plastic handled whisk for cleaning condenser and evaporator fins.



**B-26**

CATALOG NO.	DESCRIPTION	UOM	ORDER MULTIPLE
<b>B-26</b>	Fin Whisk Brush	EA	12

**Condenser/Heat Exchanger Brushes for Commercial Tube Cleaning**

For all commercial power tube cleaning machines. 1/4" and 3/8" dia. brushes have 8-32 female threads. 7/16"-1" brushes have 1/4-28 male threads. Use 7/16"-1" brushes for both CW and CCW rotation using a 1/4-28 NF jam locknut.



**B-202**

CATALOG NO.	DESCRIPTION	UOM	ORDER MULTIPLE
<b>B-202</b>	Condenser/Heat Exchanger Brush – 1/4" Brass 8-32 Female	EA	1
<b>B-204</b>	Condenser/Heat Exchanger Brush – 3/8" Brass 8-32 Female	EA	1
<b>B-207</b>	Condenser/Heat Exchanger Brush – 7/16" Brass 1/4-28 Male	EA	1
<b>B-210</b>	Condenser/Heat Exchanger Brush – 1/2" Brass 1/4-28 Male	EA	1
<b>B-213</b>	Condenser/Heat Exchanger Brush – 9/16" Brass 1/4-28 Male	EA	1
<b>B-216</b>	Condenser/Heat Exchanger Brush – 5/8" Brass 1/4-28 Male	EA	1
<b>B-219</b>	Condenser/Heat Exchanger Brush – 11/16" Brass 1/4-28 Male	EA	1
<b>B-222</b>	Condenser/Heat Exchanger Brush – 3/4" Brass 1/4-28 Male	EA	1
<b>B-228</b>	Condenser/Heat Exchanger Brush – 7/8" Brass 1/4-28 Male	EA	1
<b>B-233</b>	Condenser/Heat Exchanger Brush – 1" Brass 1/4-28 Male	EA	1
<b>B-302</b>	Condenser/Heat Exchanger Brush – 1/4" Nylon 8-32 Female	EA	1
<b>B-304</b>	Condenser/Heat Exchanger Brush – 3/8" Nylon 8-32 Female	EA	1
<b>B-307</b>	Condenser/Heat Exchanger Brush – 7/16" Nylon 1/4-28 Male	EA	1
<b>B-310</b>	Condenser/Heat Exchanger Brush – 1/2" Nylon 1/4-28 Male	EA	1
<b>B-313</b>	Condenser/Heat Exchanger Brush – 9/16" Nylon 1/4-28 Male	EA	1
<b>B-316</b>	Condenser/Heat Exchanger Brush – 5/8" Nylon 1/4-28 Male	EA	1
<b>B-319</b>	Condenser/Heat Exchanger Brush – 11/16" Nylon 1/4-28 Male	EA	1
<b>B-322</b>	Condenser/Heat Exchanger Brush – 3/4" Nylon 1/4-28 Male	EA	1
<b>B-328</b>	Condenser/Heat Exchanger Brush – 7/8" Nylon 1/4-28 Male	EA	1
<b>B-333</b>	Condenser/Heat Exchanger Brush – 1" Nylon 1/4-28 Male	EA	1
<b>B-402</b>	Condenser/Heat Exchanger Brush – 1/4" Stainless 8-32 Female	EA	1
<b>B-404</b>	Condenser/Heat Exchanger Brush – 3/8" Stainless 8-32 Female	EA	1
<b>B-407</b>	Condenser/Heat Exchanger Brush – 7/16" Stainless 1/4-28 Male	EA	1
<b>B-410</b>	Condenser/Heat Exchanger Brush – 1/2" Stainless 1/4-28 Male	EA	1
<b>B-413</b>	Condenser/Heat Exchanger Brush – 9/16" Stainless 1/4-28 Male	EA	1
<b>B-416</b>	Condenser/Heat Exchanger Brush – 5/8" Stainless 1/4-28 Male	EA	1
<b>B-419</b>	Condenser/Heat Exchanger Brush – 11/16" Stainless 1/4-28 Male	EA	1
<b>B-422</b>	Condenser/Heat Exchanger Brush – 3/4" Stainless 1/4-28 Male	EA	1
<b>B-428</b>	Condenser/Heat Exchanger Brush – 7/8" Stainless 1/4-28 Male	EA	1
<b>B-433</b>	Condenser/Heat Exchanger Brush – 1" Stainless 1/4-28 Male	EA	1

**CALIPERS**

**Digital Fractional Calipers**

Our calipers are made of a heavy duty stainless steel construction. There is a convenient auto on/off feature and a three mode digital display: decimal inches, fractions, and metrics. The accuracy on this product is +/- 0.001in. to +/- 0.02mm. The product has a resolution of 0.0005in., 0.01mm, 1/64in. and includes a battery.



6-T147

CATALOG NO.	DESCRIPTION	UOM	ORDER MULTIPLE
6-T147	Range: 0 - 6" (0 - 153mm)	EA	1

**CHANNELLOCK® PRODUCTS**

**Tongue and Groove Pliers**

These patented design pliers have permalock fasteners and reinforcing edge. The grips are also dipped in plastic for a more comfortable hold.



545-430

545-440

CATALOG NO.	DESCRIPTION	UOM	ORDER MULTIPLE
545-420	9-1/2" Tongue and Groove Pliers	EA	1
545-422	9-1/2" Curved Jaw Tongue and Groove Pliers	EA	1
545-424	4-1/2" Tongue and Groove Pliers	EA	1
545-426	6-1/2" Tongue and Groove Pliers	EA	1
545-430	10" Tongue and Groove Pliers	EA	1
545-440	12" Tongue and Groove Pliers	EA	1
545-442	12" Curved Jaw Tongue and Groove Pliers	EA	1
545-460	16" Tongue and Groove Pliers	EA	1

**CLIPBOARDS**

**Clipboards and Form Holders**

Rugged aluminum construction to protect your paperwork and forms. Smooth aluminum surfaces provide excellent writing support.

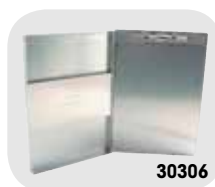

30306

CATALOG NO.	DESCRIPTION	UOM	ORDER MULTIPLE
30306	SNAPAK Clipboard on Box w/Hinged Back - 8-1/2" x 12"	EA	1
30309	REDI-RITE Clipboard on Box - 8-1/2" x 12"	EA	1
30310	CRUISER MATE 2 Compartment Clipboard - 8-1/2" x 12"	EA	1

**ELECTRICAL SUPPLIES**

**Outdoor Extension Cord**

Heavy duty, round, vinyl extension cord designed for industrial use. Orange vinyl jacket protects against oil, grease, ozone, and gives added flexibility at below freezing temperatures. Vinyl plugs and connectors are molded on and won't break or pull off cord.



CATALOG NO.	DESCRIPTION	UOM	ORDER MULTIPLE
7-ECC12100	100' Extension Cord, 12/3 SJTW-A, 15 AMP	EA	3
7-ECC1225	25' Extension Cord, 12/3 SJTW-A, 15 AMP	EA	10
7-ECC1250	50' Extension Cord, 12/3 SJTW-A, 15 AMP	EA	6
7-ECC16100	100' 13 Amp Extension Cord SJTW-A 16/3	EA	6
7-ECC1625	25' 15 Amp Extension Cord SJTW-A 16/3	EA	24
7-ECC1650	50' 15 Amp Extension Cord SJTW-A 16/3	EA	12
7-ECC50725	25' 15 AMP Extension Cord SJTW-A 14/3	EA	14
7-ECC50730	50' 15 AMP Extension Cord SJTW-A 14/3	EA	10
7-ECC50735	100' 13 AMP Extension Cord SJTW-A 14/3	EA	5

Type: SJTW-A U.L. Listed, meets OSHA Requirements.

**Power Blocks**

Professional design gives contractors and industrial personnel maximum flexibility in arranging portable power needs at the job site. Vinyl connectors are solid molded for high resistance to breakage and abuse.



CATALOG NO.	DESCRIPTION	UOM	ORDER MULTIPLE
7-AD010000	Triple tap power block adapter converts single 15 AMP 125V U-ground outlet to 3 15A, 125V U-ground outlets	EA	10

**Metal Guard Trouble Lights**

Designed for rugged use by contractors and industrial. Tough plastic handles are heat and shock resistant, with switch and 15A, 125V grounding side outlet.



CATALOG NO.	DESCRIPTION	UOM	ORDER MULTIPLE
7-TLC10625	25' Metal Guard Trouble Light	EA	1
7-TLC10630	50' Metal Guard Trouble Light	EA	1

AWG: 16/3 TYPE: SJTW-A U.L. Listed, meets OSHA Requirements.

**Rough Service Light Bulbs**

Designed to withstand unusual shock and abuse on drop cords, mechanic trouble lights, extension cords and anywhere else severe shocks may be encountered. 4 bulbs per box for 100 watt bulbs. 4 bulbs per box for 75 watt bulbs. 120/case.



CATALOG NO.	DESCRIPTION	UOM	ORDER MULTIPLE
7-75W	75 Watt Rough Service Bulb – Bulk Packed	EA	120
7-100W	100 Watt Rough Service Bulb – Bulk Packed	EA	120

**FIN TOOLS**

**Multi-Head Fin-Tool**

Conveniently straightens and cleans condenser and evaporator fins. Each nylon head slides into the master handle and tightens in place. Heads are designed to fit units with fin spacing of 4–24 fins per inch. Each head is engraved with its own size and is color coded for fast identification. Heads are angled so that when inserted in the handle, the hand is a safe distance from the sharp fins. Heads may also be reversed in the handle so that combing with an upward stroke (recommended method) may be done easily with proper leverage. The master handle rests comfortably in a man size grip, is rigid and long lasting.



CATALOG NO.	DESCRIPTION	UOM	ORDER MULTIPLE
T-1	Handle Only – Black	EA	1
T-8	Head 8 FPI – Orange, pack of 3	PK	1
T-9	Head 9 FPI – Yellow, pack of 3	PK	1
T-10	Head 10 FPI – Natural, pack of 3	PK	1
T-100	Kit – 1 Handle and 6 Heads: 8, 9, 10, 11, 12, 14	EA	12
T-101	Kit – 1 Handle and 6 Heads: 13, 15, 16, 17, 18, 20	EA	12
T-11	Head 11 FPI – Blue, pack of 3	PK	1
T-12	Head 12 FPI – Green, pack of 3	PK	1
T-14	Head 14 FPI – Lt. Green, pack of 3	PK	1
T-13	Head 13 FPI – Pink, pack of 3	PK	1

CATALOG NO.	DESCRIPTION	UOM	ORDER MULTIPLE
T-15	Head 15 FPI – Aqua, pack of 3	PK	1
T-16	Head 16 FPI – Brown, pack of 3	PK	1
T-17	Head 17 FPI – Blue, pack of 3	PK	1
T-18	Head 18 FPI – Red, pack of 3	PK	1
T-20	Head 20 FPI – Purple, pack of 3	PK	1
T-21	Head 21 & 22 FPI – Rose (for Carrier unit), pack of 3	PK	1
T-23	Head 23 & 24 FPI – Black (for Carrier unit), pack of 3	PK	1

U.S. Patent No. 4,018,076.

**FIN TOOLS cont'd**

**Fin-Tool**

Long lasting metal fin straightener. Straightens and cleans condenser and evaporator fins. One tool for all units. The heavy duty spring wire bristles automatically adjust to ALL fin spacings. An exclusive tension adjustment band is featured to allow maximum rigidity and ease of operation. Straightens most severely damaged fins.



CATALOG NO.	DESCRIPTION	UOM	ORDER MULTIPLE
<b>T-200</b>	Fin-Tool	EA	1
<b>T-300</b>	Fin-Tool with heavy duty bicycle handle	EA	12

**SuperComb**

Easier to grip, easier to use tool for straightening condenser and evaporator fins. Straightens 50% more fins in one stroke. Keeps hands a safe distance from fins. Easy to grip, strong, durable, heavy duty nylon. Color coded for easy identification. Sold individually or 6 per set. Sales display available.



CATALOG NO.	DESCRIPTION	UOM	ORDER MULTIPLE
<b>T-400</b>	Set of 6 – 1 Ea.:T-408, T-409, T-411, T-410, T-417, T-418	EA	1
<b>T-408</b>	8 and 10 FPI – Orange	EA	1
<b>T-409</b>	9 and 15 FPI – Yellow	EA	1
<b>T-411</b>	11 and 13 FPI – Blue	EA	1
<b>T-412</b>	12 and 14 FPI – Green	EA	1
<b>T-417</b>	16 and 17 FPI – Lime	EA	1
<b>T-418</b>	18 and 20 FPI – Red	EA	1

**FLASHLIGHTS AND LANTERNS BY RAYOVAC®**

**Rayovac is the Industrial Product Leader!**

Rayovac is the leader in the industrial battery market and has been for years, with an estimated 50% share of the traditional industrial distribution channel. Rayovac introduced the top-selling industrial flashlight to the market, and set the quality standard by which all other industrial flashlights are measured today. Whether your customer is searching for a toolbox-tough flashlight or high-performance batteries, Rayovac offers a broad range of products to meet your needs.

**Rayovac Industrial Flashlights and Lanterns**

Rayovac Industrial Flashlights are made of toolbox tough polypropylene construction which makes them scratch resistant and they have an unbreakable lens. There is a full lifetime warranty on this USA made product.



CATALOG NO.	DESCRIPTION	UOM	ORDER MULTIPLE
<b>7-301K</b>	Krypton Beam Lantern with 918 Battery	EA	1
<b>7-16V-B2</b>	6 Volt Industrial Lantern with Battery	EA	2
<b>7-IN2</b>	2 Cell D Size	EA	6
<b>7-IN2K</b>	2 Cell D Size with Krypton Bulb	EA	6
<b>7-IN2MS</b>	2 Cell D Size Orange MSHA and UL Approved	EA	6

**Rayovac LED Flashlights**

This flashlight is water resistant with a machined aluminum with knurled grip and a bronze finish. There is a full lifetime warranty on this USA made product. A holster is included with this item.



CATALOG NO.	DESCRIPTION	UOM	ORDER MULTIPLE
<b>7-LUX2AA3W-B</b>	Highbeam 2AA 80 Lumen	EA	4
<b>7-SE4W3C</b>	Sportsman Extra 3C Lumen	EA	4
<b>7-SPHW3AAA-BX</b>	Sportsman 3AAA 20 Lumen	EA	6

**Rayovac Industrial Swivel Lights**

The 90 Degree pivoting head shines light exactly where you're working with this light. The stand up base, built in hanging ring and non roll design make it easy to position. The rubber handle and end caps are designed for durability and comfort. The beam is a 200% brighter Krypton beam.



CATALOG NO.	DESCRIPTION	UOM	ORDER MULTIPLE
<b>7-ILJ2AA-B</b>	2 Cell AA Size Swivel Lite with Batteries	EA	6
<b>7-ISL2D-B</b>	2 Cell D Size Swivel Lite with Batteries	EA	6

**Rayovac Roughneck Flashlights**

Roughneck flashlights have a superior dependability and toughness. They feature a spot to flood focus with a Krypton bulb and are chemical and solvent resistant.



CATALOG NO.	DESCRIPTION	UOM	ORDER MULTIPLE
<b>7-R2D</b>	2 Cell D Size Roughneck	EA	6
<b>7-R2AA-B</b>	2 Cell AA Size Roughneck w/Batteries	EA	6
<b>7-R3D</b>	3 Cell D Size Roughneck	EA	6



**FLASHLIGHTS BY MAG-LITE®**

Each Mag-Lite Flashlight offers these features: 1. Exclusive cam-driven beam that changes from spot to flood with a turn of the head. 2. Patented, self-cleaning switch. 3. High quality White Star Krypton bulb (second bulb included in the tail cap) 4. High grade rubber O-rings at each opening to insure water resistance and enhance ability to withstand shock. 5. Anodized finish both inside and out to offer optimum corrosion resistance. 6. Limited lifetime warranty. 7. Manufactured in the USA.

**Mag-Lite® C and D Cell Flashlights**

Police, security, emergency, medical and fire professionals have come to rely on Mag-Lite C and D Cell flashlights more than any other brand. They know serious duty demands serious equipment. The finest flashlight in the world!



CATALOG NO.	DESCRIPTION	UOM	ORDER MULTIPLE
<b>7-S2C016</b>	2 Cell C Mag-Lite Flashlight – Black	EA	1
<b>7-S2D016</b>	2 Cell D Mag-Lite Flashlight – Black	EA	1
<b>7-S3D016</b>	3 Cell D Mag-Lite Flashlight – Black	EA	1
<b>7-S4C016</b>	4 Cell C Mag-Lite Flashlight – Black	EA	1
<b>7-S4D016</b>	4 Cell D Mag-Lite Flashlight – Black	EA	1

**Mini Mag-Lite®**

Until the Mini Mag-Lite was introduced, no one had ever dreamed a flashlight could be so small, yet so powerful. Named as one of the “products America makes best” by Fortune and Money magazines.



CATALOG NO.	DESCRIPTION	UOM	ORDER MULTIPLE
<b>7-AM2A056</b>	Mini Mag-Lite AA Holster – Black	EA	12
<b>7-M2A016</b>	Mini Mag-Lite AA – Black	EA	1
<b>7-M2A026</b>	Mini Mag-Lite AA – Camouflage	EA	1
<b>7-M2A036</b>	Mini Mag-Lite AA – Red	EA	1
<b>7-M3A016</b>	Mini Mag-Lite AAA – Black	EA	1

**Mag-Lite® Replacement Bulbs**

This selection of bulbs includes replacements for the Mini Mag Lite as well as the Magna Lite products.



CATALOG NO.	DESCRIPTION	UOM	ORDER MULTIPLE
<b>7-LK3A001</b>	Solitaire Replacement Bulb – 2 per Card	EA	12
<b>7-LM2A001</b>	Mini Mag-Lite AA Replacement Bulb – 2 per Card	EA	12
<b>7-LWSA301</b>	3 Cell C or D Replacement Bulb – 2 per Card	EA	12
<b>7-LWSA401</b>	4 Cell C or D Replacement Bulb – 2 per Card	EA	12

**Magna-Lite**

Unbreakable pocket flashlite/magnifier. Ideal for checking small serial numbers and names on compressors or where poor light makes reading difficult. Powerful, optical-quality magnifying lens. Lightweight. Replacable penlight batteries.



CATALOG NO.	DESCRIPTION	UOM	ORDER MULTIPLE
<b>ML-100</b>	Magna-Lite – 1-1/2 oz.	EA	12

**Mag Charger System**

The ultimate, rechargeable lighting tool; the most powerful and durable hand-held flashlight of its size. Battery pack is rechargeable 1000 times. Electro-formed reflector emits an incredibly bright, high intensity light. Includes: Mag Charger Flashlight, charging unit, battery pack, two mounting brackets, 12V Cigarette Lighter Adapter, and 110V AC Converter.



CATALOG NO.	DESCRIPTION	UOM	ORDER MULTIPLE
<b>7-RX1019</b>	Mag Charger System	EA	1

**GAUGES**

**Manifold Gauge**

DiversiTech's MG-1 Manifold Gauge provides the technician with a precision diagnostic and monitoring analog gauge set complete with hoses.

The Manifold Gauge and Hose Set includes:

- 2 valve brass manifold
- 5' long high pressure hose set
- For use with the following refrigerants:
  - R-410A
  - R-22
  - R-407C
- Detailed gauge readings in PSI °F

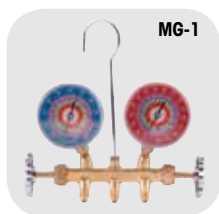

CATALOG NO.	DESCRIPTION	UOM	ORDER MULTIPLE
<b>MG-1</b>	Manifold Gauge and Hose Set	EA	1
<b>MG-RGB</b>	Replacement Gauge – blue	EA	1
<b>MG-RGR</b>	Replacement Gauge – red	EA	1
<b>MG-ORING</b>	Replacement O-ring	EA	1

**Sheet Metal Gauge**

The Sheet Metal Gauge is used for gaging uncoated sheet metal, plate iron, and steel. The Gauge numbers are US Standard O to 36. Satin finished, heavy gauge hardened/tempered steel with decimal equivalents of each size stamped on the reverse side. The gauge is 3 1/4in. diameter and is 3/32in. thick.



CATALOG NO.	DESCRIPTION	UOM	ORDER MULTIPLE
<b>6-T21</b>	Steel Sheet Metal Gauge – 3-1/4" diameter, 3/32" thick	EA	1

**HOBBY AND CUTTING KNIVES**

**The Quad™ 14-Piece Saw/Driver Set**

A 4 in 1 cutting and driving system set. Included in the set are a Jab Saw with straight handle and special Sheetrock reciprocal blade, a Keyhole Saw in the pistol grip handle position, a Power Drive in the pistol grip position, and the Speed Driver, screw or nut driver with a straight handle. The Keyless Quick Change locking chuck accepts both Quick change bits and industry standard reciprocating saw blades. The 14 piece set includes 3 Reciprocating saw blades, drywall, Metal/PVC, wood, .4in. magnetic speed lock bit holder, 7 of the most popular insert bits, a 1/4in. hex to square drive insert bit adaptor fir using 1/4in. sockets; (bits not included); 2 position quick change locking handle and a convenient holster with belt clip. The swivel locking chuck holds all reciprocating blades and speed shank power bits. A comfortable handle easily locks in the straight or pistol grip position.

CATALOG NO.	DESCRIPTION	UOM	ORDER MULTIPLE
<b>6-T86014</b>	14-Piece Saw/Driver Set	EA	1

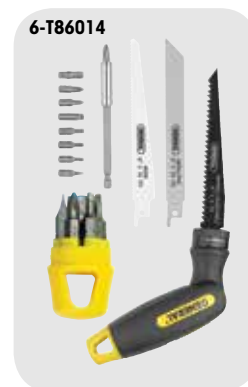

**HVAC AIRFLOW INSTRUMENTS**

**Digital One-Piece Air Flow Meter with CFM Display**

This Meter displays CFM, FPM, MPH, KPH, MPS, temp and knots. This easy, single hand airflow measure has a handy recessed service grip with single and multi point averages. There is a Min/ Max, data, hold F/C switch and an RS 232 output. The range is 14 to 122 F (10 to 50C). The air flow range is 80 to 5900 FPM (0.4 to 30 m/s). The accuracy is +/- 3 % full scale, +/- 1 F (+/- 1C). The display is 1.25in. x 1.625in. with dimensions of 7in. x 2.25in. x 1.75in.. The meter includes 1 9V batter in a molded hard case.

CATALOG NO.	DESCRIPTION	UOM	ORDER MULTIPLE
<b>6-DCFM8906</b>	Digital One-Piece Air Flow Meter with CFM Display	EA	1



**MANOMETERS, PRESSURE**

**Hydrogauge Manometer**

- Economical Pressure measurements.
- Replaces ordinary U-tube manometers
  - Measures gas pressure easily and efficiently
  - Direct reading, no plus or minus readings to add together as in old fashioned U-tubes
  - Fills like a glass of water, no more air bubbles
  - Strong magnet for mounting
  - Heavy-duty construction
  - Made of industrial grade, flexible PVC plastic
  - Lightweight; Easy to use
  - 6-HG15 water column height: 15"
  - Plastic: 30" to 36" of industrial grade flexible plastic
  - Hose fitting: All brass
- Includes: Mounting magnet.

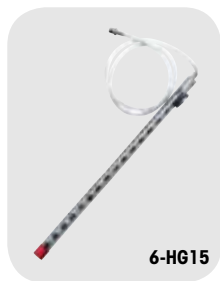

6-HG15

CATALOG NO.	DESCRIPTION	UOM	ORDER MULTIPLE
6-HG15	Hydrogauge Manometer	EA	1

**Gas Pressure Test Kit**

- Rugged, Heavy Duty Field Use.
- Measure Natural gas (methane) or LP gas pressure across appliance manifolds.
  - Test gas stoves, furnaces, dryers and other gas appliances. Can also be used for other non-corrosive gases.
  - Large 2" sensitive diaphragm gauge is calibrated in inches of water column, also shows ounces per square inch
  - Magnified lens
  - Easier to use than a manometer
  - Range: 0 to 35 inches of water column (in. H<sub>2</sub>O) 0 to 20 ounces per square inch (oz./in<sup>2</sup>)
- Includes: 2" sensitive diaphragm gauge; 3' of rubber tubing; brass fitting for quick connection to the appliance manifold 3/8" NPT; molded hard case.



6-GPK035

CATALOG NO.	DESCRIPTION	UOM	ORDER MULTIPLE
6-GPK035	Gas Pressure Test Kit	EA	1

**MEASURING TAPES, STAPLES AND STAPLE GUNS**

**Power Measuring Tapes**

Rust resistant yellow lacquered blade with easy to read inch/foot markings (English). Neon case has belt clips and finger-tip blade lock. Ultralife tape is our highest quality tape measure - lasts up to 10 times longer than typical blades, with patented "blade wiper" that cleans the blade as you measure.

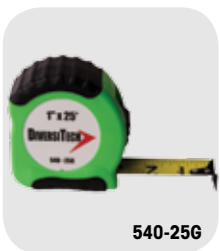

540-25G

CATALOG NO.	DESCRIPTION	UOM	ORDER MULTIPLE
540-25G	Power Tape – Neon Green 1" x 25'	EA	6
540-25R	Power Tape – Neon Orange 1" x 25'	EA	6

**T-50 Series Staples and Staple Guns**

The #1 selling staple gun in the world! Used extensively by building contractors, home do-it-yourselfers and specialty trade applications for tacking insulation, ceiling tile, window screening, cornerite, and 1001 other jobs ranging from light to heavy duty work. The T-50 Outward Clinch Staple Gun is ideal for fiberglass ductwork.

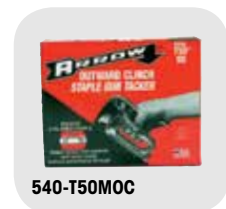

540-T50MOC



CATALOG NO.	DESCRIPTION	UOM	ORDER MULTIPLE
540-504	1/4" Leg Staples for T50 Staple Guns (1,250)	EA	4
540-506	3/8" Leg Staples for T50 Staple Guns (1,250)	EA	4
540-508	1/2" Leg Staples for T50 Staple Guns (1,250)	EA	4
540-509	9/16" Leg Staples for T50 Staple Guns (1,250)	EA	4
540-T50M	T50M Heavy Duty Staple Gun Tacker	EA	1
540-T50MOC	T50MOC Outward Clinch Staple Gun	EA	1

**METERS, DETECTORS, ALARMS**

**HVACR Refrigerant Leak Detector**

- Industrial and Automotive uses.
- Detects ALL halogenated refrigerants
  - Sensitivity adjustment dial
  - High sensitivity
  - Equipped with quality sensor
  - Flexibility up to 3 gr/yr
  - Microcomputer processor control
- Includes: 2 "C" batteries.



6-RLD202

CATALOG NO.	DESCRIPTION	UOM	ORDER MULTIPLE
6-RLD202	HVACR Refrigerant Leak Detector	EA	1

**High Performance Refrigerant Leak Detector with Pump**

The Leak Detector is designed for HVAC, Industrial, Automotive, and small leaks. There is microprocessor control with advanced digital signal processing. It includes multi color display, high-median-low leak sensitivity selector, and semiconductor gas sensor. The detector detects of R-134a, R-404A, R-410A, R-407C, R22, and Freon gas. There is reference leak source included as well as 4 AA Alkaline batteries, leak check bottle, and molded hard case.



6-RLD382P

CATALOG NO.	DESCRIPTION	UOM	ORDER MULTIPLE
6-RLD382P	High Performance Refrigerant Leak Detector w/Pump	EA	1

**METERS, DETECTORS, ALARMS cont'd**

**Mini AC AMP Clamp Meter**

HVAC, Industrial uses.

- Data hold
- Auto ranging
- Easy-to-use
- Continuity beeper
- Low battery indicator
- Auto power off
- Jumbo LCD display
- AC voltage: to 600V
- AC current: to 600A
- Resistance: to 200V
- Sampling rate: 2 times/second
- Jaw opening: 1"
- Dimensions: 7.4" x 2" x 1.3"
- Weight: 7.4 oz.

Includes: 2 "AAA" batteries; all weather test leads; soft carrying case.



6-DAMP221

CATALOG NO.	DESCRIPTION	UOM	ORDER MULTIPLE
6-DAMP221	Mini AC AMP Clamp Meter	EA	1

**Digital UL Listed Multimeter**

Economical Electrical Readings.

- 7 Functions – 20 Ranges
- High Impact Thermoplastic Case
- Simple Operation
- Small Pocket Size
- Safety Recessed Test Lead Connections
- Ranges and Accuracy
- AC Voltage: 0-200/600 Vac, ±2.5%
- DC Voltage: 0-200mV/2/20/200/600 Vdc, ±2%
- DCCurrent: 0-2000uA/20m/200mA/10Adc, ±1%
- Resistance: 0-200/2k/20k/200k/2M/20M $\Omega$ , ±1.5%

Includes: Battery Test; Diode Test; Continuity Buzzer.

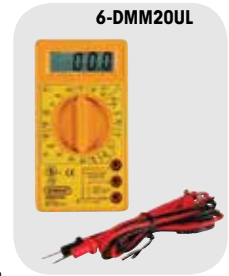

6-DMM20UL

CATALOG NO.	DESCRIPTION	UOM	ORDER MULTIPLE
6-DMM20UL	Digital UL Listed Multimeter	EA	1

**Digital Multimeter with Bright Screen Display**

Autoranging, Easy-to-Use, Easy-to-See.

- 10 Functions – 37 Ranges
- Manual and Autoranging
- High Impact Thermoplastic Case
- Simple Operation
- Safety Recessed Test Lead Connections
- Overload Protection on all Ranges
- Audible Continuity
- 10A AC/DC Range
- Data Hold
- Auto Power Off
- Backlit LCD Display
- Ranges and Accuracy

- AC Voltage: 0-200mV/2/20/200/600 Vac, ±1%
- DC Voltage: 0-200mV/2/20/200/600 Vdc, ±0.5%
- AC Current: 0-2mA/20m/200mA/10Aac, ±1.5%
- DC Current: 0-2mA/20m/200mA/10Adc, ±1.2%
- Resistance: 0-200/2k/20k/200k/2M/20M $\Omega$ , ±1%
- Capacitance: 0-20n/200nF/2u/20u/100uF, ±3%
- Frequency: 1-20/200/2k/20k/200k/2MHz, ±0.2%
- Duty Cycle: 0.1 to 99.9%, ±1%

Includes: Test leads; 1 "9V" battery.



6-DMM45

CATALOG NO.	DESCRIPTION	UOM	ORDER MULTIPLE
6-DMM45	Digital Multimeter with Bright Screen Display	EA	1

**MISCELLANEOUS TOOLS**

**Compressor TOTE**

Makes light work of a heavy job. Powder coated, strong steel construction. Recommended for use with all compressors up to 5 tons. Compatible with high efficiency compressors. Pick up a compressor from its box. Carry a compressor up a ladder. Now with black protective finish.



ACT-6

CATALOG NO.	DESCRIPTION	UOM	ORDER MULTIPLE
ACT-6	Compressor Tote	EA	6

**Mechanical Screw Starter**

A simple, easy way to end fumbling with hard to position screws. Just insert the screw on the prongs of the screw starter, and a simple twist will lock the screw ready for trouble free starting. Tool automatically releases and resets. Use with ferrous or non-ferrous screws. Nylon handle.



S-3

CATALOG NO.	DESCRIPTION	UOM	ORDER MULTIPLE
S-3	One End Slotted, Phillips on Other, 9-1/4"	EA	1

MISCELLANEOUS TOOLS cont'd

**Expando Adjustable Condenser Tube Cleaner**

Removes mineral scale and sludge from inside water-cooled condenser tubes fast! Saves time-consuming brushing or flushing. Attaches to a threaded rod which fits into an Expando handle or your electric drill. With a reaming action, the stainless steel blades scrape inside the tube, providing an unrestricted flow. Virtually clogproof, it expands or reduces in diameter to fit scale deposits—not just the tube. Use EC-810 couplings for connecting additional rods.



E-5

CATALOG NO.	DESCRIPTION	UOM	ORDER MULTIPLE
E-10	Condenser Tube Cleaner – 5/8" to 3/4" I.D. Tubes	EA	1
E-5	Condenser Tube Cleaner – 5/16" to 3/8" I.D. Tubes	EA	1
E-6	Condenser Tube Cleaner – 3/8" to 1/2" I.D. Tubes	EA	1
E-8	Condenser Tube Cleaner – 1/2" to 5/8" I.D. Tubes	EA	1
EB-10	Blades for E-10	EA	1
EB-6	Blades for E-5 and E-6	EA	1
EB-8	Blades for E-8	EA	1
EC-56	Couplings for E-5 and E-6	EA	3
EC-810	Couplings for E-8 and E-10	EA	3
EH-1	Handle	EA	1

**Telescopic Inspection Mirror**

Fast, accurate visual inspection of hidden areas with an almost limitless number of positions. Double ball joint links swivel mirrors for viewing to 360°. Precision engineered links are made from tempered spring steel to withstand the stresses of constant repositioning. Moves freely, holds desired position.



M-1

CATALOG NO.	DESCRIPTION	UOM	ORDER MULTIPLE
M-1	Mirror – 1-1/4" Circular – extends 6-1/4" to 18-1/4"	EA	1
M-1R	Replacement Head for M-1	EA	1
M-2	Mirror – 2-1/4" Circular – extends 10" to 14"	EA	1
M-2R	Replacement Head for M-2	EA	1
M-3	Mirror – 2-1/8" x 3-1/2" Rectangular – extends 11-1/4" to 15-1/4"	EA	1
M-3G	Refill Mirrors Only 2-1/8" x 3-1/2"	EA	12
M-3R	Replacement Head for M-3	EA	1
M-4	Mirror – 7/8" Circular – extends 6-1/2"	EA	1
M-4R	Replacement Head for M-4	EA	1
M-5	Mirror – 1" x 2" Oval – extends 8-1/2"	EA	1
M-5G	Refill Mirrors Only Oval 1" x 2"	EA	12
M-5R	Replacement Head for M-5	EA	1

**4-Piece Hook and Pick Set**

For separating wires, removing small fuses, "O" rings, retrieving washers and loose parts too small to pick up with your fingers. Bright-dipped, anodized hex-shaped aluminum handles with powerful magnet on end. Handy screw-in hook, pick, point and scribe. High carbon polished needle steel. All in a compact zip-lock vinyl pouch that fits in your shirt pocket! Set includes four screw-in tips plus handle.



MHP-4

CATALOG NO.	DESCRIPTION	UOM	ORDER MULTIPLE
MHP-4	4-Piece Hook and Pick Set	EA	1

MONITORS

**007 Control Checker**

A lifetime tool for monitoring and checking safety controls and operating controls. One unit for all voltages 24-460 VAC or DC without switching dials or meters. Compact, 4 oz, reliable. Saves troubleshooting. For normally closed controls, 007 connects in parallel with safety control. When the safety control opens in response to a problem in the system, 007 red LED turns on and remains on until reset manually. With intermittent problem, the LED remains on indicating the control is open. For operating controls, 007 verifies the status of all types indicating if there is power to the holding coil, the NC contact is open or closed, the thermostat contacts are open or closed, there is power to the contactor or starting holding coil, the overloads are open or closed, or there is a bad connection either on control or power side. NOTE: May use with lockout relays. Features battery check and reset switch. Includes 9-volt battery. 007 may be used over and over.



TC-007

CATALOG NO.	DESCRIPTION	UOM	ORDER MULTIPLE
TC-007	007 Control Checker	EA	1

U.S. Pat. No. 4,092,625.

**Tattle-Tale Control Monitor**

Identifies open controls in seconds. A single use monitoring device for determining which safety control has opened in response to a malfunction. Saves wasted hours tracing a safety control shutdown, even if intermittent. A quick, inexpensive way to visually spot where the problem is. Simply install in parallel with each safety control. When a control opens, the red indicator flag pops up. You will know immediately which area of the system is experiencing problems. Disposable, safe, simple to use, and pocket sized. Monitors safety controls, fuses, overload relays, motor protectors, freeze controls, limit controls, safety switches, fusible links, or steam control. CAUTION: Not to be used with lockout relays, use TC-007.



TT-24

CATALOG NO.	DESCRIPTION	UOM	ORDER MULTIPLE
TT-120	Tattle-Tale Control Monitor – 120 Volt AC or DC, pack of 3	PK	1
TT-24	Tattle-Tale Control Monitor – 24 Volt AC or DC, pack of 3	PK	1
TT-240	Tattle-Tale Control Monitor – 240 Volt AC or DC, pack of 3	PK	1

Tolerance on all voltages shown is ± 20%. U.S. Pat. No. 4,250,480.

**NUT SETTERS**

**Nut Setter – Power**

The Magnetic hex driver nut setter can be used with any 1/4in. power bit and are individually packed.



CATALOG NO.	DESCRIPTION	UOM	ORDER MULTIPLE
<b>5-MSH1/4MC</b>	Hex Drive – 1/4", 1-3/4" long, 1/4" nut	EA	30
<b>5-MSH5/16MC</b>	Hex Drive – 1/4", 1-3/4" long, 5/16" nut	EA	30

**Magnetic Nut Setters – Bulk**

Magnet hex driver setter to be used with any 1/4in. power bit and are package in bulk.



CATALOG NO.	DESCRIPTION	UOM	ORDER MULTIPLE
<b>540-400</b>	Magnetic Nut Setters – 1/4", pack of 30	EA	1
<b>540-500</b>	Magnetic Nut Setters – 5/16", pack of 30	EA	1

**REFRACTOMETERS**

The Refractometer can measure the freezing point of coolants and the Charge Condition of Batteries



CATALOG NO.	DESCRIPTION	UOM	ORDER MULTIPLE
<b>6-REF401</b>	Refractometer	EA	1

**RETRIEVING TOOL/MINI-LIGHTS**

**Telescoping Mini-Light and Magnetic Pickup**

This pickup tool is ideal for retrieving steel and iron parts from hard to reach and see work areas. The magnet is fitted in a 5-1/2in. (140mm) long ergonomically designed handle. The light bulb on this product has a life of 100,000 hours of continuous use. The Mini-Light is fastened to a chrome plated brass wand with a double ball joint. The pickup comes with 4 Alkaline LR41 batteries which have a life of 48 continuous hours. This is a powerful permanent magnetic pick-up tool.



CATALOG NO.	DESCRIPTION	UOM	ORDER MULTIPLE
<b>6-T582</b>	Telescoping Mini-Light and Magnetic Pickup	EA	1

**Reach-It**

Our Reach-It is made of durable chrome plated brass and retracts to 5in. long. A match can quickly be inserted with the Reach-It.



CATALOG NO.	DESCRIPTION	UOM	ORDER MULTIPLE
<b>R-1</b>	Reach-It – extends to 26-3/4"	EA	12

**Mechanical Pickup**

Strong four prong steel jaws help retrieve small items from hard to reach places. The flexible shaft helps to avoid obstacles. The smooth actuator allows for greater control while the chrome finish prevents rust.

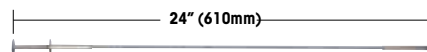
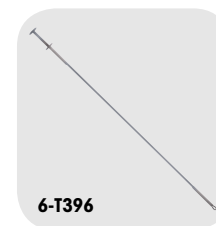

CATALOG NO.	DESCRIPTION	UOM	ORDER MULTIPLE
<b>6-T396</b>	4-Prong Steet Jaws; Chrome Finished w/Flexible Shaft	EA	1

**Magnetic Retrieving Tool**

Extra high flux magnet for greater pickup. Super adjustable telescoping action. Bright chrome plated brass handle. Outperforms the standard Alinco V Magnet 4 to 1. The telescoping handle lets you pick up ferrous objects where your hand cannot reach. Fits in your pocket when closed for easy accessibility.

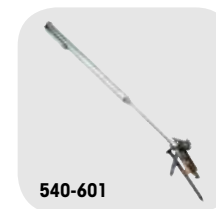

CATALOG NO.	DESCRIPTION	UOM	ORDER MULTIPLE
<b>540-601</b>	Tool – Pocket Telescopic extends from 5-7/8" (12cm) to 25-9/16" (63cm) – Carded	EA	12

**SAWS AND SAW BLADES**

**Deluxe Hi-Tension Hacksaw**

Hackframe featuring handle and end pieces made of die cast aluminum. Lightweight yet rigid and highly tensioned (up to 25,000 psi) for cleaner, surer cut. Permanent blade pins feature versatile angling (up to 55°) for flush cutting. Blade can be inserted in handle to be used as compass saw. Frame will fit most standard tool boxes.



CATALOG NO.	DESCRIPTION	UOM	ORDER MULTIPLE
540-278BM0024	Replacement Blades for Hacksaw Frame 12" x 24T	EA	10
540-278HX0002	Hacksaw Frame with Blade	EA	1

**Bi-Metal Reciprocating Saw Blades**

Premium high speed steel with a flexible alloy back. Bi-metal blades fit all reciprocating saws with 1/2" shank.



CATALOG NO.	DESCRIPTION	UOM	ORDER MULTIPLE
540-R8CCRF	Cast Iron-Ceramic Tile Carbide Grit 8" Long	EA	1
540-RB125W	12" x 6T Wood and Nail 3/4" x 12" x .050	EA	5
540-RB414M	4" x 14T Short Metal Cutting 3/4" x 4" x .035	EA	5
540-RB418M	4" x 18T Short Metal Cutting 5/8" x 4" x .035	EA	5
540-RB424M	4" x 24T Thin Short Metal Cutting 5/8" x 4" x .035	EA	5
540-RB610HDM	6" x 10T HD Metal Cutting 3/4" x 6" x .035	EA	5
540-RB614HDM	6" x 14T HD Metal Cutting 3/4" x 6" x .035	EA	5
540-RB618HDM	6" x 18T HD Metal Cutting 3/4" x 6" x .035	EA	5
540-RB624HDM	6" x 24T HD Metal Cutting 3/4" x 6" x .035	EA	5
540-RB636DW	Drywall Cutting with V Head 5/8" x 6" x .035	EA	5
540-RB636W	6" x 6T Wood and Nail Slope 3/4" x 6" x .050	EA	5
540-RB656WS	6" x 6T Wood and Nail Scroll 3/4" x 6" x .050	EA	5
540-RB810HDM	8" x 10T HD Metal Cutting 3/4" x 8" x .035	EA	5
540-RB814HDM	8" x 14T HD Metal Cutting 3/4" x 8" x .035	EA	5
540-RB956W	9" x 6T Wood and Nail 3/4" x 9" x .050	EA	5

**SCALES**

**Electronic Utility Scales**

Constructed for heavy duty weighing. Perfect for warehouse use, check weighing, large crates and shipping freight. Low profile platform. Control panel can be wall mounted for easy viewing. Large LCD display. Operates with AC adapter (included) or one 9V battery (not included).



CATALOG NO.	DESCRIPTION	UOM	ORDER MULTIPLE
660-004	150 lb. Capacity (Pelouze #4010)	EA	1
660-005	400 lb. Capacity (Pelouze #4040)	EA	1

**Utility Scales**

Large easy to read dial can be viewed from top or side. Low profile enables you to slide cartons and crates onto scale. Memory Lock holds reading when dial is obscured. Perfect for shipping and receiving parcels or crates in the mailroom or warehouse.



CATALOG NO.	DESCRIPTION	UOM	ORDER MULTIPLE
660-002	100 lb. Capacity (Pelouze #P100S)	EA	1
660-003	250 lb. Capacity (Pelouze #P250S)	EA	1

**SCREWDRIVERS, DRIVER SETS**

**Pocket 4-in-1 Mini Screwdriver**

This screwdriver set is ideal for technicians, hobbyists, and do it yourselfers. There are 2 double-ended vanadium blades. You can change blades instantly and the blades are held in the carrier handled. The dimensions are 1/16in. and 1/8in. slotted tips and #1 and #00 cross point. The Mini Screwdriver comes in with a convenient pocket clip and capped ends.

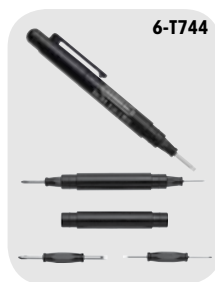

CATALOG NO.	DESCRIPTION	UOM	ORDER MULTIPLE
6-T744	Pocket 4-in-1 Mini Screwdriver – Length: 5-1/8" (130mm)	EA	1

**6-in-1 Flip Driver**

High-quality precision screwdriver for mechanics, technicians, hobbyists, and do it yourselfers. The carrier doubles as a 1/4in. and 5/16in. Nut Driver that fits snugly in the handle. There are 2 double-ended blades, 3/16in. x No 1, and 1/4in. x No. 2 Phillips that are held in a reversible carrier. You can change blade sizes instantly and the precision engineered 800 Series Versa-Grip handle ensures maximum performance.

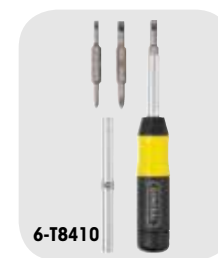

CATALOG NO.	DESCRIPTION	UOM	ORDER MULTIPLE
6-T84101	6-in-1 Flip Driver (Carded)	EA	1

SCREWDRIVERS, DRIVER SETS cont'd

Combination Screwdrivers

Multiple bits in one handy screwdriver. No need for a toolbox for those quick jobs. Lifetime guarantee.



CATALOG NO.	DESCRIPTION	UOM	ORDER MULTIPLE
5-41	4-in-1 with #1 and #2 Phillips, 3/16 and 5/16 Slotted	EA	12
5-61	6-in-1 with #1 and #2 Phillips, 3/16 and 5/16 Slotted 1/4 Nut Driver, 5/16 Nut Driver	EA	12

SNIPS, NOTCHERS, CRIMPERS, SEAMERS

Aviation Snips

Moly alloy tool steel blade is hot drop-forged and scientifically heat-treated to provide a strong, longer lasting cutting edge. Durable serrated blades are designed to grip the metal for cutting ease. The patent pending spring on these snips is guaranteed to last for the life of the tool. Will cut 18 gauge cold-rolled steel.



CATALOG NO.	DESCRIPTION	UOM	ORDER MULTIPLE
540-6716B	Aviation Snip – Bulldog Notching Snip – Blue Handle	EA	6
540-6716L	Aviation Snip – Cuts Left – Red Handle	EA	6
540-6716R	Aviation Snip – Cuts Right – Green Handle	EA	6
540-6716S	Aviation Snip – Cuts Straight – Yellow Handle	EA	6

HVAC Tools

Hot drop-forged carbon steel blades. Compound leverage action handles. Heavy duty plastic grips.



CATALOG NO.	DESCRIPTION	UOM	ORDER MULTIPLE
540-FCTMC5	8" Crimper – 22 Ga. Crimping Capacity	EA	1
540-FCTMN1	8" Notcher – 31° Cutting Angle	EA	1
540-FCTMS1	3" Straight Seamer – 22 Ga. Capacity	EA	1
540-FCTMS2	3" Offset Seamer – 22 Ga. Capacity	EA	1

Offset Snips

The same high quality construction as the Aviation Snips with an additional advantage – the Offset Snips allow your hand to stay above metal for cutting ease and comfort.



CATALOG NO.	DESCRIPTION	UOM	ORDER MULTIPLE
540-6510L	Offset Snip – Cuts Left – Red Handle	EA	6
540-6510R	Offset Snip – Cuts Right – Green Handle	EA	6

Upright Snips

This snip significantly improves sheet metal cutting. The ergonomic design allows for easier cutting in tight places, improved safety by elevating hands above metal working surfaces, and increases wrist range motion.



CATALOG NO.	DESCRIPTION	UOM	ORDER MULTIPLE
540-6900L	Upright Snips – Left-handed Model	EA	6
540-6900R	Upright Snips – Right-handed Model	EA	6

Tinner Snips

Constructed of the finest quality high carbon tool steel. Hot drop-forged and heat-treated to assure strength and durability. "Kush-N-Cote" vinyl coated handles for added comfort. Available in a Straight Pattern for a powerful straight cutting snip or Duckbill Pattern for cutting scrolls, circles, or straight lines. 12-1/2" long.

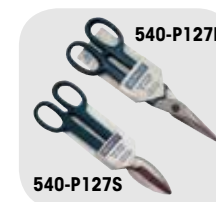

CATALOG NO.	DESCRIPTION	UOM	ORDER MULTIPLE
540-P127D	Duckbill Tinner Snip	EA	6
540-P127S	Straight Cutting Tinner Snip	EA	6



**STRAPS, TRUCK ROPE**

**Truck Rope**

All-purpose high strength polypropylene truck rope is C.H.P. approved.



CATALOG NO.	DESCRIPTION	UOM	ORDER MULTIPLE
25001	Truck Rope – 3/8" x 50'	EA	1
CR070	Truck Rope – 3/8" x 50' (Yellow)	EA	1

**Ratchet Strap**

Easy ratcheting permits tie-down of appliances securely. An innovative latch and a fast release cam reduces socket wear. Cadmium-plated steel buckle has a positive lock that eliminates release due to vibration. When closed, the handle locks the latch into the sprocket to prevent inadvertent release. 16' nylon webbing rated at 3000 PSI tensile. Vinyl coated end hooks rated at 1200 PSI tensile.



CATALOG NO.	DESCRIPTION	UOM	ORDER MULTIPLE
HS-192	Ratchet Strap – 16'	EA	3

**Hanging Strap**

Strong, versatile, easy way to secure loose gear safely. Tie down ladders, tubing, cylinders or almost anything in seconds. Cannot snap back. Strong, durable 1" polypropylene webbing. Reinforced grommet lets you hang it up, tie it up, hook it up or attach it permanently. Spring loaded adjustable buckle. Easy to get firm tension with no slipping. Make an endless length by connecting 2 or more together.



CATALOG NO.	DESCRIPTION	UOM	ORDER MULTIPLE
HS-30	Hanging Strap – 31"	EA	24
HS-30-2	Hanging Strap – 31", 2 Straps per Card, pack of 12	PK	1
HS-60	Hanging Strap – 60"	EA	24
HS-60-2	Hanging Strap – 60", 2 Straps per Card, pack of 12	PK	1

**Canopy Strap**

Canopy ties are ideal for stretching or holding tarps and canopies tight. Easy to use and install and won't damage tarps or canopies. Convenient ball design for easy installation and securing. 10" length.



CATALOG NO.	DESCRIPTION	UOM	ORDER MULTIPLE
RS-TS10	Canopy Straps, 10 in, pack of 12	PK	1

**Lashing Strap**

Quickly lashes and secures refrigerators, air conditioners, washers, driers, etc. Strong nylon webbing rated at 3000 lbs. and end hooks at 1200 lbs. tensile strength. Hand loop for easy tightening. Steel cam lever buckle is easy to adjust and releases quickly. Secures a maximum load of 1000 pounds. 12' long.



CATALOG NO.	DESCRIPTION	UOM	ORDER MULTIPLE
HS-144	Lashing Strap – 144"	EA	6

**Heavy Duty Ratchet Strap**

The Highland Titan Max Grip ratchet system is designed for heavy duty use and supports loads up to 1,000 lbs with a breaking strength of 3,000 lbs. Features include a full open grip handle that fits any size hand comfortably, soft grip, and a contoured handle.



CATALOG NO.	DESCRIPTION	UOM	ORDER MULTIPLE
HS-168HD	Heavy Duty Ratchet Strap	EA	2

**Rubber Tie Down Strap**

Can stretch to double its length. Quickly ties down ladders, tubing, cylinders or almost anything. Extra heavy steel "S" hooks on each end. Resists cracking and deterioration.



CATALOG NO.	DESCRIPTION	UOM	ORDER MULTIPLE
RS-9	Rubber Tie Down Strap – 10"	EA	10
RS-15	Rubber Tie Down Strap – 15"	EA	10
RS-20	Rubber Tie Down Strap – 20"	EA	10
RS-31	Rubber Tie Down Strap – 31"	EA	10
RS-41	Rubber Tie Down Strap – 41"	EA	10

**Carabiners**

Carabiners come in a 2 piece package and are made of 8 mm anodized aluminum. Great for attaching ropes and clipping to tool belts. For indoor or outdoor use – work or leisure. Various colors.

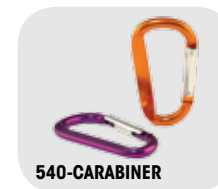

CATALOG NO.	DESCRIPTION	UOM	ORDER MULTIPLE
540-CARABINER	Carabiner Clip, pack of 2	PK	1

**TEST LEADS**

**Test Leads**

Alligator clips are covered by pure vinyl boots for flexibility at any temperature without cracking.



CATALOG NO.	DESCRIPTION	UOM	ORDER MULTIPLE
<b>ACK4</b>	2 Red and 2 Black Boots w/4 Alligator Clips	EA	1
<b>FTL3</b>	Pair, Red and Black – 36"	EA	1
<b>FTL3D</b>	Pair, Red and Black – Super Heavy Duty – 36"	EA	1

**Multi Color Test Leads**

Easy to use multi-colored test leads. 5 colors (white, red, black, yellow, green) with 2 connections each for easy testing on the job. Wire is 18 gauge, 18" long.



CATALOG NO.	DESCRIPTION	UOM	ORDER MULTIPLE
<b>CT800</b>	Multi Color Test Leads	EA	1

**All Weather Test Leads**

These flexible soft leads are ideal for cold months. They have medium alligator clips and insulated boots and are 300V. The leads have 10 amps and are 18 gauge. They are 36in. long and weigh 0.26 lbs.



CATALOG NO.	DESCRIPTION	UOM	ORDER MULTIPLE
<b>6-TL360W</b>	All Weather Test Leads – 36" Length	EA	1

**Standard Test Leads**

These are handy jumper test leads with medium alligator clips and insulated boots. The wire gauge is 16 gauge with a length of 36in. The volts are 300V and these leads are 10 amps and weigh 0.12 lb.

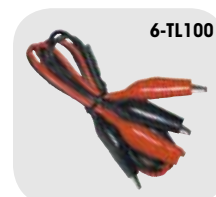

CATALOG NO.	DESCRIPTION	UOM	ORDER MULTIPLE
<b>6-TL100</b>	Standard Test Leads – 36" Length	EA	1

**TESTERS**

**Test Cord (Female)**

Heavy duty red and black boots are on this cord. The cord has large clips, 3 wires, and is 24in. With this cord, you can get power in remote areas without an 110V outlet. The voltage is 3 to 20 V and has 125 AMPs. The wire gauge is 16 and the weight is .36 lb.



CATALOG NO.	DESCRIPTION	UOM	ORDER MULTIPLE
<b>6-CT700F</b>	Test Cord (Female)	EA	1

**Leak Test Gauge**

This Gas gauge test is ideal for teasing all new installations of or leaks and passing inspection code. The special sensitive diaphragm gauges for more accurate low pressure readings.



CATALOG NO.	DESCRIPTION	UOM	ORDER MULTIPLE
<b>TG-05</b>	Leak Test Gauge – 3/4" FPT., 15 psi	EA	1
<b>TG-30-12</b>	Leak Test Gauge – 1/2" FPT. Conn., 30 psi	EA	1
<b>TG-30</b>	Leak Test Gauge – 3/4" FPT. Conn., 30 psi	EA	1
<b>TG-30-1</b>	Leak Test Gauge – 1" FPT. Conn., 30 psi	EA	1

**LED Screwdriver Continuity Tester**

A Screwdriver/Tester you can see! The tester is a self-test with AC Voltage test of 70 to 250 BAC. You can also check continuity and fuses. There is also a polarity check and the product has bright red LED. When the tip of the tester is in direct contact with the live (HOT) part of the AC voltage, the red LED lights up for an easier read and better accuracy.



CATALOG NO.	DESCRIPTION	UOM	ORDER MULTIPLE
<b>6-ST600LED</b>	Red LED Screwdriver Continuity Tester	EA	1

**THERMOMETERS/PROBES**

**Digital Thermometer**

Temperature range from -40° F to 230° F. Packaged on attractive display card.



CATALOG NO.	DESCRIPTION	UOM	ORDER MULTIPLE
541-300	Digital Thermometer	EA	1

**Deluxe Digital Pocket Thermometer**

Deluxe Digital Pocket Thermometers are water and drop resistant and have a rugged construction. There is an auto power off and an F/C Switch. The probe is 2.5in. and the range is from -40 degrees F to 300 degrees F or -40 degrees C to 150 degrees C. This thermometer comes with a protective cover with clip.



CATALOG NO.	DESCRIPTION	UOM	ORDER MULTIPLE
6-HDT303K	Deluxe Digital Pocket Thermometer	EA	1

**30:1 High Performance Ultra Wide-Range Infrared Thermometer**

The Infrared thermometer is a high precision and high performance unit that can be used in most industrial applications including furnaces and heat exchangers. There is a switchable On/Off Laser sighting and also has a high/ low audible alarm. There is a Backlit LCD Display with a 10 point memory and low Battery Indicator. The product is F/C switchable and has a Min/Max/Ave along with Auto Measuring. The response time is 500 ms with a resolution of 0.1F (0.1C). An ergonomic design and electronic trigger lock make it comfortable and easy to use. The range is -25.6 to 1400 degrees F (-32 to 760C) and has a distance to spot ratio of 30:1. The thermometer has an operating temp of 32 to 122 degrees F (0 to 50 C) and includes 1 9V battery, an instruction manual, and a carrying case.



CATALOG NO.	DESCRIPTION	UOM	ORDER MULTIPLE
6-IRT670	30:1 High-Performance Ultra Wide-Range Infrared Thermometer	EA	1

**Pocket HVAC General Purpose Infrared Thermometer**

A general purpose infrared thermometer is convenient and takes accurate measurements in most HVAC/R application and industrial jobs. The thermometer has a lock function, min/max readings and has a response time of 1 second. The distance to spot ratio is 6:1 and the accuracy is +/- 0.6 F/C. This easy to use item fits in your pocket and includes a 9V battery and neck strap.



CATALOG NO.	DESCRIPTION	UOM	ORDER MULTIPLE
6-IRT203	Pocket HVAC Infrared Thermometer (Blister packed)	EA	1

**Digital Psychrometer – Precision Temperature and Humidity Instrument**

This product has an electronic capacitance type polymer film sensor with a microprocessorbased design. There is an F/C Switch Data hold with wet and dry bulb temperature. The accuracy on this product is +/-5% @25 C from 10 % to 90% RH Temp +/-1 C, 1 F (all temp ranges). With a low battery indicator, memory, and batteries included this item is a must!



CATALOG NO.	DESCRIPTION	UOM	ORDER MULTIPLE
6-SAM990DW	Digital Psychrometer	EA	1

**Pocket Thermometers**

1" diameter dials with 5" stems (.145 dia.). Adjustable for recalibration. All stainless steel construction. Polycarbonate crystal. 1% accuracy full scale. Plastic pocket sheath included.

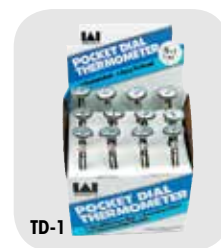

CATALOG NO.	DESCRIPTION	UOM	ORDER MULTIPLE
TD-1	Pocket Thermometer – 0°F to 220°F	EA	12
TD-2	Pocket Thermometer – -40°F to 160°F	EA	12

**12:1 S/B Refrigeration, A/C and Food Service Infrared Thermometer**

This Thermometer is ideal for sub cooling applications, particularly food service, refrigeration, and air conditioning. There is a switchable On/Off Laser sighting along with temperature data storage. There is a Backlit LCD Display with a 10 point memory and low Battery Indicator. The product is F/C switchable and has a Min/Max/Ave along with Auto Measuring. The response time is 500 ms with a resolution of 0.1F (0.1C). An ergonomic design and electronic trigger lock make it comfortable and easy to use. The range is -25.6 to 1400 degrees F (-32 to 760C) and has a distance to spot ratio of 30:1. The thermometer has an operating temp of 32 to 122 degrees F (0 to 50 C) and includes 1 9V battery, an instruction manual, and a carrying case.



CATALOG NO.	DESCRIPTION	UOM	ORDER MULTIPLE
6-IRT656	12:1 S/B Refrigeration, A/C, and Food Service Infrared Thermometer	EA	1
IRT657	Tools, Infrared Thermometer	EA	1

**Digital Thermometer with 2 K-Type Probes and Case**

This thermometer is ideal for use in labs, industrial control and audits and measuring differential temperatures. There is a dual probe input and the thermometer accepts K-type thermocouple probes. There is T1/T2 temperature differential. It is DE approved and has a data and max hold. The product includes 1 LR44 battery, molded hard case and 2 K type beaded tip probes.



CATALOG NO.	DESCRIPTION	UOM	ORDER MULTIPLE
6-DT8803	Digital Thermometer with 2 K-Type Probes and Case	EA	1

**THERMOMETERS/PROBES** cont'd

**Horizontal Refrigerator/Freezer Analog Thermometer**

With this analog thermometer, you can use it either hanging or free standing. The easy to ready display can be seen with a horizontal reading. Both F and C scales are reflected on the thermometer and the range is -40 to 80 degrees F (-40 to 27C).

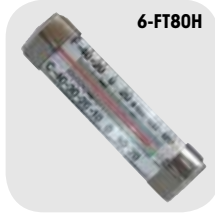

CATALOG NO.	DESCRIPTION	UOM	ORDER MULTIPLE
6-FT80H	Horizontal Refrigerator/Freezer Analog Thermometer	EA	1

**Refrigerator/Freezer Analog Thermometer**

This analog thermometer is stainless steel and can be used either hanging or free standing. The easy to read round dial is in F only. There are temperature indicators with a range -20 to 80 F (-29 to 27 C)



CATALOG NO.	DESCRIPTION	UOM	ORDER MULTIPLE
6-FT80R	Refrigerator/Freezer Analog Thermometer	EA	1

**Analog Pocket Thermometer with Magnifying Lens**

- Range 6-320: -40° to 160°F
  - Range 6-321: -0° to 220°F
  - Rugged stainless steel probe
- Includes: Protective sheath with pocket clip.

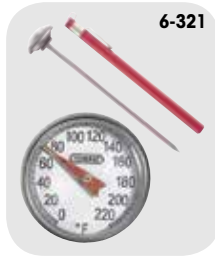

CATALOG NO.	DESCRIPTION	UOM	ORDER MULTIPLE
6-320	Analog Pocket Thermometer: Range -40° to 160°F	EA	1
6-321	Analog Pocket Thermometer: Range -0° to 220°F	EA	1

**Jumbo Display Indoor/Outdoor Thermometer**

You can measure and monitory both indoor and out temperatures with this thermometer. Included are a water resistant outdoor probe with a 12 foot cable, mounting accessories, and AAA battery. This product monitors indoor temps of 32 to 122 degrees F and outdoor temps of -58 to 158 degrees F. You can either wall mount this thermometer or stand it up for a desktop display. There is a 12/24 hour clock on it as well.



CATALOG NO.	DESCRIPTION	UOM	ORDER MULTIPLE
6-DT898P	Jumbo Display Indoor/Outdoor Thermometer	EA	1

**Digital Temperature and Humidity Pen**

This pen is ideal for HVAC, laboratories, hospitals, computer rooms, green houses, printing, film processing, and more. There is a simultaneous display of relative humidity and temperature. Data hold freezes measured values and an F/C switch make this a nice addition to the toolbox. The pen includes a CR2032 battery and a pocket clip on back.



CATALOG NO.	DESCRIPTION	UOM	ORDER MULTIPLE
6-PTH8708	Digital Temperature and Humidity Pen	EA	1

**Refrigerator/Oven Thermometer**

The oven thermometer is made of stainless steel with a range of 150 to 600 degrees F (50 to 300C). This item can either be free standing or hanging with an easy to read dial.



CATALOG NO.	DESCRIPTION	UOM	ORDER MULTIPLE
6-OT550	Refrigerator/Oven Thermometer	EA	1

**Digital Jumbo Display Service Thermometer**

For use in labs, industrial controls and food service applications. It displays ambient temperature and remote temperature via probe. The temperature alarm function with high and low limits. There is audible and visual alarm set points along with a clock display with hours and minutes. The probe is immersible in water and there is a sensor wire compartment. The thermometer comes with 1 AAA battery and a wrist strap.



CATALOG NO.	DESCRIPTION	UOM	ORDER MULTIPLE
6-PT300M	Digital Jumbo Display Service Thermometer	EA	1

**TOOL BAGS**

**Double Zipper Rigger's Bag**

Rugged, lightweight soft-sided tote/organizer for tools and business accessories. Features double pull top zipper for easy access, reinforced bottom panel to keep bag's wide profile, and padded carrying handle. Total of 50 multi-use pockets!

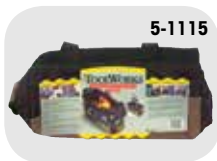

CATALOG NO.	DESCRIPTION	UOM	ORDER MULTIPLE
5-1115	Double Zipper Rigger's Bag	EA	1

**TUBE WORKING TOOLS**

**Kut-All Plastic Tube and Hose Cutter**

Tough, durable nylon. Blade closes into its own handle for safe handling. Replaceable high carbon, teflon coated steel blades. Ideal for cutting up to 1-1/8" I.D. plastic tubing, reinforced plastic tubing, rigid plastic pipe, and rubber hose.



CATALOG NO.	DESCRIPTION	UOM	ORDER MULTIPLE
PK-2	Kut-All Plastic Tube and Hose Cutter	EA	1
PK-2B	Replacement Blades	EA	1

**E-Z™ Ratchet II Tube and Pipe Cutter**

This Cutter cuts without rotating the tool completely around the tube or pipe. This product ratchets in 5 degree increments while cutting 360 degree around the tube. With a large cutting diameter of 1/8in. to 1-1/8in. (3mm – 28mm), this cutter has the exclusive One-Hand operation. This cutter can cut copper, aluminum, brass, thin wall tubing, and stainless steel.



CATALOG NO.	DESCRIPTION	UOM	ORDER MULTIPLE
6-T135	Capacity: 1/8" to 1-1/8" (3mm-28mm)	EA	1

**One-Handed PVC/Hose Cutter**

The ratchet system holds the blade in place while you adjust your grip to increase the pressure. The high carbon steel blade maintains sharpness and resists chipping. These cutters can be used for cutting PVC, CPVC, Polyethylene, PEX, and ABS tubing. The cutters have a quick-blade reset and can be used as a one handed operation. With the handle locking strap for safe storage, the easy replacing blade feature, and the ergonomically designed handle, these cutters are a perfect addition to any tool box.



CATALOG NO.	DESCRIPTION	UOM	ORDER MULTIPLE
6-T1191	Capacity: 1/8" to 1-5/8"; Length: 8-1/4" (210mm)	EA	1
6-T1191BG	Replacement Blade	EA	1

**E-Z™ Ratchet Tubing Cutter**

The ratcheting action rotates the cutter around the tube which allows a standard size cutter to be used in close quarter applications. The longer handle requires less effort to rotate the cutter which helps reduce hand fatigue. Wide hardened flared groove rollers allow true cuts close to flared end tubing to avoid tube replacement in existing installations. This cutter can cut copper, aluminum, brass, thin wall tubing, and stainless steel. An additional cutting wheel is supplied in the handle.

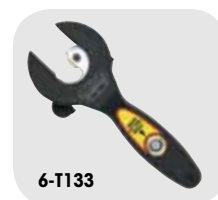

CATALOG NO.	DESCRIPTION	UOM	ORDER MULTIPLE
6-T133	Capacity: 5/16" to 1-1/8" (8mm – 30mm)	EA	1

**Little Helper™ – All Purpose Cutter**

Cuts up to 1-1/4" polyethylene, thinwall PVC, ABS, rubber hose, NM conduit and clear vinyl tubing. Reversible stainless steel blade, like two blades in one. Sturdy all metal construction.



CATALOG NO.	DESCRIPTION	UOM	ORDER MULTIPLE
548-001	Little Helper™ – Carded	EA	1
548-002	Replacement Blades	EA	1

**Plier Flaring Tool**

Our flaring tool is made of all-steel construction. The freewheeling cone self centers accurately over the tubing. Quick release allows insertion and removal of tubing easily. The quick release plier action handles hold tubing securely while flaring. The product can be used in confined areas and the vinyl handles make for comfortable use.



CATALOG NO.	DESCRIPTION	UOM	ORDER MULTIPLE
6-T152	Capacity: 3/16", 1/4", 5/16", 3/8", 1/2", 5/8"	EA	1

**TUBE WORKING TOOLS** cont'd

**Swivel Head Deburring Tool**

This Swivel head Deburring Tool has the professional quality and the performance of a higher price deburring tool without the price tag. This product has two interchangeable blades.



CATALOG NO.	DESCRIPTION	UOM	ORDER MULTIPLE
6-T482	Handle length: 5-1/8" (130mm)	EA	1
6-T482A	Blade for steel, copper, aluminum and plastic	EA	1

**PVC Ratchet Cutter**

The high carbon steel blades on this cutter provide longer sharpness and clean cuts. The aluminum body is lighter and corrosion resistant. The safety locking clasp and ratchet action make for easy cutting. They can be used for repeated heavy duty cutting of hose, PVC, CPVC, polyethylene, PEX, and ABS of up to 2 in.



CATALOG NO.	DESCRIPTION	UOM	ORDER MULTIPLE
6-T118	Capacity up to 2in. (50mm), Length 17in. (425mm)	EA	1

**Big Helper™ PVC Pipe Cutter**

Ratchet style pipe cutters cut up to 2-1/2 in. Sch. 40 PVC Pipe. Ratchet action requires minimal pressure to easily cut through PVC pipe. Molybdenum stainless steel blade won't rust or break and lasts twice as long as most competitor's. The Mega-Cutter is now available – the strongest pipe cutter on the market today!



CATALOG NO.	DESCRIPTION	UOM	ORDER MULTIPLE
548-003	1in. O.D. Cutting Capacity	EA	1
548-004	1in. Replacement Blade	EA	1
548-005	1-1/4in. O.D. Cutting Capacity	EA	1
548-006	1-1/4in. Replacement Blade	EA	1
548-007	2-1/2in. O.D. Mega-Cutter	EA	1
548-008	2-1/2in. Mega-Blade	EA	1
548-009	1-5/8in. O.D. Cutting Capacity	EA	1
548-010	1-5/8in. Replacement Blade	EA	1

**WELDING TORCHES, SUPPLIES**

**Heat Resistant Cloth**

This flame barrier drop cloth withstands temperatures to 3,000°F. No asbestos. Protects walls, floors, equipment, components and adjacent surfaces from torch flames when soldering, brazing or welding. All cloths have edges taped and sewn with grommets at each corner. Highly resistant to many chemicals and acids.

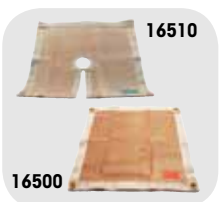

CATALOG NO.	DESCRIPTION	UOM	ORDER MULTIPLE
16500	18" x 18" Plain	EA	1
16510	18" x 18" Keyhole w/cutout for draping over pipes/tubes	EA	1
16520	36" x 36" Plain	EA	1

**Map-Pro and Propane Gas**

Map-Pro and Propane Gas are tanks that can be used to weld products.



CATALOG NO.	DESCRIPTION	UOM	ORDER MULTIPLE
525-MT1	Map-Pro Gas – 14 oz.	EA	12
525-PT1	Propane Gas – 14.1 oz.	EA	12

**Portable Hand Torch**

Self igniting hand torch eliminates the need for a flint lighter. Lightweight and portable, this flame tool can be operated with Propane or MAP-Pro™ (Propylene). Features trigger lock with instant safety release, full size comfort grip and 360° swivel tip. Operates in any position, even upside down. Includes swirl combustion tip end.



CATALOG NO.	DESCRIPTION	UOM	ORDER MULTIPLE
525-TORCH	Portable Hand Torch	EA	1

# PLUMBING

CPVC-CTS Pipe and Fittings.....	182
Nylon Fittings .....	182-183
Oatey® Products .....	184
PVC Condensate Pipe .....	186
PVC DWV Fittings .....	186
PVC Primer and Cement .....	185
PVC Schedule 40 Pressure Fittings.....	187-190
Supports .....	190
Tubing, Clamps, and Kits .....	190-191



**CPVC-CTS PIPE AND FITTINGS**

**CPVC-CTS Pipe by FlowGuard® Gold™**

CTS = Copper Tube Size

CATALOG NO.	DESCRIPTION	UOM	ORDER MULTIPLE
4700-12	1/2" x 10' CPVC Pipe, 500'	EA	500'
4700-34	3/4" x 10' CPVC Pipe, 250'	EA	250'



4700-12

**CPVC-CTS Fittings by FlowGuard® Gold™**

CTS = Copper Tube Size

CATALOG NO.	DESCRIPTION	UOM	ORDER MULTIPLE
4701-12	1/2" Coupling S x S	EA	20
4703-12	1/2" Adapter F x S	EA	25
4704-12	1/2" Adapter M x S	EA	20
4706-12	1/2" 45° Elbow S x S	EA	20
4707-12	1/2" 90° Elbow S x S	EA	20
4711-12	1/2" Tee S x S x S	EA	20
47072-12	1/2" 90° Street Ell S x S	EA	10
4718-12	3/4" x 1/2" CPVC Bushing	EA	10
4701-34	3/4" Coupling S x S	EA	20
4703-34	3/4" Adapter F x S	EA	25
4704-34	3/4" Adapter M x S	EA	10
4706-34	3/4" 45° Elbow S x S	EA	20
4707-34	3/4" 90° Elbow S x S	EA	20
4711-34	3/4" Tee S x S x S	EA	20
47072-34	3/4" 90° Street Ell S x S	EA	10



4703-12

**NYLON FITTINGS\***

**Male Adapter (Barb x MIPT)**



701-001

CATALOG NO.	DESCRIPTION	UOM	ORDER MULTIPLE
701-001	Adapter – 1/2 Barb x 1/2 MIPT, pack of 2	PK	1
701-002	Adapter – 1/2 Barb x 3/4 MIPT, pack of 2	PK	1
701-003	Adapter – 1/2 Barb x 3/8 MIPT, pack of 2	PK	1
701-004	Adapter – 1/4 Barb x 1/4 MIPT, pack of 2	PK	1
701-005	Adapter – 1/4 Barb x 3/8 MIPT, pack of 2	PK	1
701-007	Adapter – 3/4 Barb x 3/4 MIPT, pack of 2	PK	1
701-012	Adapter – 3/8 Barb x 1/2 MIPT, pack of 2	PK	1
701-013	Adapter – 3/8 Barb x 3/8 MIPT, pack of 2	PK	1
701-014	Adapter – 5/8 Barb x 3/4 MIPT, pack of 2	PK	1
701-042	Adapter – 3/8 Barb x 1/4 MIPT, pack of 2	PK	1
701-043	Adapter – 3/8 Barb x 3/4 MIPT, pack of 2	PK	1

**Female Adapter (Barb x FIPT)**



701-006

CATALOG NO.	DESCRIPTION	UOM	ORDER MULTIPLE
701-006	Adapter – 3/4 Barb x 3/4 NPT, pack of 2	PK	1
701-041	Adapter – 1/2 Barb x 1/2 NPT, pack of 2	PK	1
701-053	Adapter – 1/2 Barb x 3/4 NPT, pack of 2	PK	1

**Bushing (MIPT x FIPT)**



701-015

CATALOG NO.	DESCRIPTION	UOM	ORDER MULTIPLE
701-015	Bushing – 1 MIPT x 3/4 FIPT, pack of 2	PK	1
701-017	Bushing – 3/4 MIPT x 1/2 FIPT, pack of 2	PK	1

**Garden Hose Adapters**



701-008

CATALOG NO.	DESCRIPTION	UOM	ORDER MULTIPLE
701-008	Adapter – 3/4 MGHT x 3/4 FGHT, pack of 2	PK	1
701-009	Adapter – 3/4 MGHT x 3/4 FIPT, pack of 2	PK	1
701-010	Adapter – 3/4 MGHT x 3/4 MIPT, pack of 2	PK	1
701-011	Adapter – 3/4 MIPT x 3/4 FGHT, pack of 2	PK	1

\*All fittings packaged with identification. To order nylon fittings in bulk, enter catalog number followed by the letter "B." For example, 701-001B is the bulk part number for 701-001. Bulk sold in packs of 100.



**Elbow (Barb x Barb)**



CATALOG NO.	DESCRIPTION	UOM	ORDER MULTIPLE
701-018	Elbow – 1/2 Barb, pack of 2	PK	1
701-023	Elbow – 3/4 Barb, pack of 2	PK	1
701-040	Elbow – 5/8 Barb, pack of 2	PK	1
701-046	Elbow – 3/8 Barb, pack of 2	PK	1

**Female Adapter Elbow (Barb x FIPT)**



CATALOG NO.	DESCRIPTION	UOM	ORDER MULTIPLE
701-019	Elbow – 1/2 Barb x 3/4 NPT, pack of 2	PK	1
701-024	Elbow – 3/4 Barb x 3/4 NPT, pack of 2	PK	1
701-055	Elbow – 1/2 Barb x 3/4 NPT Bottom Drain, pack of 2	PK	1

**Male Adapter Elbow (Barb x MIPT)**



CATALOG NO.	DESCRIPTION	UOM	ORDER MULTIPLE
701-020	Elbow – 1/2 Barb x 3/4 MIPT, pack of 2	PK	1
701-025	Elbow – 3/4 Barb x 3/4 MIPT, pack of 2	PK	1
701-026	Elbow – 3/8 Barb x 1/2 MIPT, pack of 2	PK	1
701-027	Elbow – 3/8 Barb x 3/8 MIPT, pack of 2	PK	1
701-028	Elbow – 5/8 Barb x 3/4 MIPT, pack of 2	PK	1

**Hose Mender (Barb x Barb)**



CATALOG NO.	DESCRIPTION	UOM	ORDER MULTIPLE
701-029	Hose Mender – 1/2 Barb, pack of 2	PK	1
701-030	Hose Mender – 1/4 Barb, pack of 2	PK	1
701-031	Hose Mender – 3/4 Barb, pack of 2	PK	1
701-032	Hose Mender – 3/8 Barb, pack of 2	PK	1
701-033	Hose Mender – 5/8 Barb, pack of 2	PK	1

**Tee (Barb x Barb x Barb)**



CATALOG NO.	DESCRIPTION	UOM	ORDER MULTIPLE
701-034	Tee – 1/2 Barb, pack of 2	PK	1
701-035	Tee – 1/2 x 3/4 x 1/2 Barb, pack of 2	PK	1
701-036	Tee – 1/4 Barb, pack of 2	PK	1
701-037	Tee – 3/4 Barb, pack of 2	PK	1
701-038	Tee – 3/8 Barb, pack of 2	PK	1
701-039	Tee – 5/8 Barb, pack of 2	PK	1

**Elbow (FIPT x FIPT)**



CATALOG NO.	DESCRIPTION	UOM	ORDER MULTIPLE
701-047	Elbow – 3/4 NPT, pack of 2	PK	1

\*All fittings packaged with identification. To order nylon fittings in bulk, enter catalog number followed by the letter "B." For example, 701-001B is the bulk part number for 701-001. Bulk sold in packs of 100.

**OATEY® PRODUCTS**

**PVC Cement – Clear**

PVC Cement is clear. All cans have brushtop applicator.

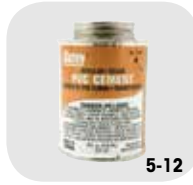

CATALOG NO.	DESCRIPTION	UOM	ORDER MULTIPLE
5-14	Oatey #31012 – 1/4 Pint	EA	24
5-12	Oatey #31013 – 1/2 Pint	EA	24
5-10	Oatey #31014 – 1 Pint	EA	24
5-32	Oatey #31015 – 32 oz.	EA	12

**Purple Primer for PVC Pipe and Fittings (Black Label)**

Recommended for all PVC and CPVC installations – all sizes/schedules. Purple tinted primer formulated to remove surface dirt and grease as well as soften the pipe surface to allow for a fast, secure and permanent solvent weld. For use in areas where codes call for primer verification.



CATALOG NO.	DESCRIPTION	UOM	ORDER MULTIPLE
530-30755	Purple Primer – 4 oz.	EA	24
530-30756	Purple Primer – 8 oz.	EA	24
530-30757	Purple Primer – 16 oz.	EA	24

NSF and UPC listed. Exceeds ASTM F-656.

**Heavy Duty PVC Cement**

Heavy bodied clear cement recommended for use on PVC pipe and fittings up to 12" in diameter for Sch. 40 and Sch. 80 potable water pressure pipe, gas, conduit, drain waste and vent pipe. Exceeds ASTM D-2564.



CATALOG NO.	DESCRIPTION	UOM	ORDER MULTIPLE
530-30850	Heavy Duty Cement – 4 oz.	EA	24
530-30863	Heavy Duty Cement – 8 oz.	EA	24
530-30876	Heavy Duty Cement – 16 oz.	EA	24

**Rain-R-Shine Blue Cement**

Medium bodied blue colored cement for PVC pipe and fittings up to 6 inches in diameter. A very fast setting cement formulated for wet conditions and/or when quick pressurization and fast installation is needed. Exceeds ASTM D-2564.



CATALOG NO.	DESCRIPTION	UOM	ORDER MULTIPLE
530-30890	Rain-R-Shine Cement – 4 oz.	EA	24
530-30891	Rain-R-Shine Cement – 8 oz.	EA	24
530-30893	Rain-R-Shine Cement – 16 oz.	EA	24

**PVC Primer – Clear**

Recommended for all PVC and CPVC applications. Can be used on all sizes and schedules. Formulated to remove all surface dirt, grease, and grime as well as soften the pipe in preparation for solvent cement. This primer can be used when you want a cleaner installation. Meets ASTM F-656 and is NSF listed.



CATALOG NO.	DESCRIPTION	UOM	ORDER MULTIPLE
530-30752	PVC Primer – Clear – 16 oz.	EA	24
530-30753	PVC Primer – Clear – 32 oz.	EA	12

**All-purpose Clear Cement for ABS, PVC and CPVC Pipe and Fittings**

Heavy-bodied clear cement recommended for use on ABS, PVC, and CPVC pipe and fittings up to 12" in diameter. Flows freely and provides a thick layer of cement on the pipe. Apply at temperatures 40° to 90°F.



CATALOG NO.	DESCRIPTION	UOM	ORDER MULTIPLE
530-30818	Clear Cement – 4 oz.	EA	24
530-30821	Clear Cement – 8 oz.	EA	24
530-30834	Clear Cement – 16 oz.	EA	24

**PVC Gray Cement for High Efficiency Furnaces, Vent and Make-Up Air**

Medium-bodied gray colored cement for use on Sch. 40 conduit, drain waste, and vent pipe. Flows freely and covers with a thicker layer than regular PVC. Can be applied at temperatures 40° to 100°F.



CATALOG NO.	DESCRIPTION	UOM	ORDER MULTIPLE
530-30884	Gray Cement – 8 oz.	EA	24
530-30885	Gray Cement – 16 oz.	EA	24

NSF and UPC listed. Exceeds ASTM D-2564.

**All Weather PVC Cement**

Medium bodied cement for PVC pipe and fittings up to 6". Formulated for fast initial set-up from -15°F to 100°F. Exceeds ASTM D-2564.



CATALOG NO.	DESCRIPTION	UOM	ORDER MULTIPLE
530-31132	All Weather Cement – 16 oz.	EA	24
530-31133	All Weather Cement – 32 oz.	EA	12

**PVC PRIMER AND CEMENT**

**Pro-Weld™ PVC Cement (Regular Body)**

Pro-Weld™ PVC Cement is a clear, regular bodied solvent cement designed to be used on Type I and II PVC pipe and fittings up to and including 4 inch diameter. Pro-Weld™ meets ASTM Standard D-2564.

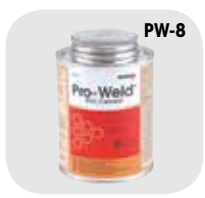

CATALOG NO.	DESCRIPTION	UOM	ORDER MULTIPLE
<b>PW-4</b>	Pro-Weld™ – 4 oz. Brush-Top Container – Regular Body	EA	24
<b>PW-8</b>	Pro-Weld™ – 8 oz. Brush-Top Container – Regular Body	EA	24
<b>PW-16</b>	Pro-Weld™ – 16 oz. Brush-Top Container – Regular Body	EA	24
<b>PW-32</b>	Pro-Weld™ – 32 oz. Brush-Top Container – Regular Body	EA	12

**Pro-Weld™ PVC Cement (Universal – PVC/ABS/CPVC)**

Pro-Weld™ Universal Cement is a clear, medium bodied, high strength cement for use on PVC to PVC, CPVC to CPVC, and ABS to ABS connections. Pro-Weld Universal sets up fast and works with all rigid schedule 40 and 80 piping up to 6 inches in diameter. Complies with ASTM D2564, D2235, and F493.



CATALOG NO.	DESCRIPTION	UOM	ORDER MULTIPLE
<b>PWU-4</b>	Pro-Weld™ – 4 oz. Brush-Top Container – Universal – PVC/ABS/CPVC	EA	24
<b>PWU-8</b>	Pro-Weld™ – 8 oz. Brush-Top Container – Universal – PVC/ABS/CPVC	EA	24
<b>PWU-16</b>	Pro-Weld™ – 16 oz. Brush-Top Container – Universal – PVC/ABS/CPVC	EA	24

**Pro-Weld™ PVC Cement (Heavy Body)**

Pro-Weld™ Heavy Body is a clear, heavy bodied, very high strength industrial grade PVC cement. It has a medium setting time and works with all rigid schedule 40 and 80 pipe diameters up to 12 inches. Complies with ASTM D2564 and NSF.



CATALOG NO.	DESCRIPTION	UOM	ORDER MULTIPLE
<b>PWH-4</b>	Pro-Weld™ – 4 oz. Brush-Top Container – Heavy Body	EA	24
<b>PWH-8</b>	Pro-Weld™ – 8 oz. Brush-Top Container – Heavy Body	EA	24
<b>PWH-16</b>	Pro-Weld™ – 16 oz. Brush-Top Container – Heavy Body	EA	24

**Pro-Prime™ PVC Primer (Purple)**

A purple-tinted primer formulated to remove dirt and oil from the surface of Type I and II PVC piping, as well as soften the piping in preparation for solvent welding. Pro-Prime™ contains purple pigment which provides verification that the primer has been applied to the pipe surface. Pro-Prime™ meets ASTM Standard F-656.



CATALOG NO.	DESCRIPTION	UOM	ORDER MULTIPLE
<b>PP-4</b>	Pro-Prime™ – 4 oz. Brush-Top Container	EA	24
<b>PP-8</b>	Pro-Prime™ – 8 oz. Brush-Top Container	EA	24
<b>PP-16</b>	Pro-Prime™ – 16 oz. Brush-Top Container	EA	24
<b>PP-32</b>	Pro-Prime™ – 32 oz. Can	EA	12

**Pro-Weld™ PVC Cement (Pool and Turf – Blue)**

Pro-Weld™ Blue Pool and Turf is a blue colored, medium bodied, high strength PVC cement for welding rigid or flexible PVC in wet conditions where the system needs to be pressurized quickly. Pro-Weld Blue Pool and Turf sets up very fast and works with all rigid and flexible schedule 40 and 80 pipe diameters up to 6 inches. Complies with ASTM D2564 and NSF.



CATALOG NO.	DESCRIPTION	UOM	ORDER MULTIPLE
<b>PWB-4</b>	Pro-Weld™ – 4 oz. Brush-Top Container – Pool and Turf – Blue	EA	24
<b>PWB-8</b>	Pro-Weld™ – 8 oz. Brush-Top Container – Pool and Turf – Blue	EA	24
<b>PWB-16</b>	Pro-Weld™ – 16 oz. Brush-Top Container – Pool and Turf – Blue	EA	24

**Pro-Prime™ Clear PVC Primer**

Clear primer that removes dirt and oil from the surface of Type I and II PVC piping. Softens the piping to prepare for solvent welding. Pro-Prime Clear primer meets ASTM Standard F-656.



CATALOG NO.	DESCRIPTION	UOM	ORDER MULTIPLE
<b>PPC-4</b>	Pro-Prime™ Clear – 4 oz. Brush-Top Container	EA	24
<b>PPC-8</b>	Pro-Prime™ Clear – 8 oz. Brush-Top Container	EA	24
<b>PPC-16</b>	Pro-Prime™ Clear – 16 oz. Brush-Top Container	EA	24
<b>PPC-32</b>	Pro-Prime™ Clear – 32 oz. Can	EA	12

**PVC CONDENSATE PIPE**

**Polyvinyl Chloride, white PVC 1120**



CATALOG NO.	DESCRIPTION	UOM	ORDER MULTIPLE
5-2002	3/4" PVC – PSI 200 – 10' Straight End	EA	500'
5-2005	3/4" PVC – PSI 200 – 20' Belled End	EA	500'
5-401	3/4" PVC – Sch. 40 – 10' Straight End	EA	500'
5-407	3/4" PVC – Sch. 40 – 20' Belled End	EA	500'
5-404	2" PVC – Sch.40/DWW,ASTM 2665 – 10' Straight End	EA	100'
5-405	3" PVC – Sch.40/DWW,ASTM 2665 – 10' Straight End	EA	50'
5-416	1" PVC – Sch. 40 – 20' Belled End	EA	200'
5-417	1-1/4" PVC – Sch. 40 – 20' Belled End	EA	200'
5-418	1-1/2" PVC – Sch. 40 – 20' Belled End	EA	200'

**PVC DWV FITTINGS**

**Couplings (Hub x Hub)**



CATALOG NO.	DESCRIPTION	UOM	ORDER MULTIPLE
5-100020	2" Couplings (Hub x Hub)	EA	100
5-100030	3" Couplings (Hub x Hub)	EA	60
510-D102251	2" x 1-1/2" Couplings (Hub x Hub)	EA	25
510-D102338	3" x 2" Couplings (Hub x Hub)	EA	20

**90 Elbow (Hub x Hub)**



CATALOG NO.	DESCRIPTION	UOM	ORDER MULTIPLE
5-300020	2" 90 Elbow (Hub x Hub)	EA	50
5-300030	3" 90 Elbow (Hub x Hub)	EA	25
510-D304020	2" Long Sweep 90 Elbow (Hub x Hub)	EA	25
510-D304030	3" Long Sweep 90 Elbow (Hub x Hub)	EA	10

**45 Elbows**



CATALOG NO.	DESCRIPTION	UOM	ORDER MULTIPLE
5-321020	2" 45 Elbow (Hub x Hub)	EA	50
5-321030	3" 45 Elbow (Hub x Hub)	EA	20
510-D323020	2" 45 Street Elbow (Hub x SPIG)	EA	50
510-D323030	3" 45 Street Elbow (Hub x SPIG)	EA	20

**DWV Bend Fittings**



CATALOG NO.	DESCRIPTION	UOM	ORDER MULTIPLE
5-300050	2" Street Ell (Hub x SPIG)	EA	50
5-300060	3" Street Ell (Hub x SPIG)	EA	20
510-D309020	2" Long Sweep (Hub x SPIG)	EA	25
510-D309030	3" Long Sweep (Hub x SPIG)	EA	20

**DWV Vent Tee**



CATALOG NO.	DESCRIPTION	UOM	ORDER MULTIPLE
510-D441020	2" Vent Tee	EA	25
510-D441030	3" Vent Tee	EA	10

**DWV Bushings**



CATALOG NO.	DESCRIPTION	UOM	ORDER MULTIPLE
510-437338	3" x 2" Reducing Bushing (SPIG x SLIP)	EA	10
510-438338	3" x 2" Bushing (SPIG x FIPT)	EA	10

**PVC SCHEDULE 40 PRESSURE FITTINGS**

**Tee (Slip x Slip x Slip)**

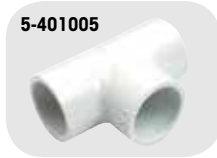

CATALOG NO.	DESCRIPTION	UOM	ORDER MULTIPLE
5-401005	1/2" Tee	EA	50
5-401007	3/4" Tee	EA	50
5-401010	1" Tee	EA	50
5-401012	1-1/4" Tee	EA	25
5-401015	1-1/2" Tee	EA	25
5-401020	2" Tee	EA	25
5-401025	2-1/2" Tee	EA	10
5-401030	3" Tee	EA	10

**Tee (Slip x FIPT x Slip)**



CATALOG NO.	DESCRIPTION	UOM	ORDER MULTIPLE
5-402007	3/4" Tee (S x S x FIPT)	EA	50
5-403007	3/4" Tee (S x FIPT x S)	EA	50

**90 Ell (Slip x Slip)**



CATALOG NO.	DESCRIPTION	UOM	ORDER MULTIPLE
5-406005	1/2" 90 Ell	EA	50
5-406007	3/4" 90 Ell	EA	50
5-406010	1" 90 Ell	EA	50
5-406015	1-1/2" 90 Ell	EA	25
5-406020	2" 90 Ell	EA	25
5-406030	3" 90 Ell	EA	10

**Traps (Slip x Slip)**

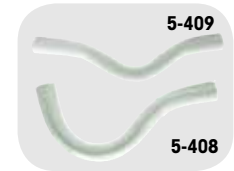

CATALOG NO.	DESCRIPTION	UOM	ORDER MULTIPLE
5-408	3/4" "P" Trap (Slip x Slip)	EA	100
5-409	3/4" Running Trap (Slip x Slip)	EA	100
5-410	3/4" Mini "P" Trap (Slip x Slip)	EA	100
5-411	1" "P" Trap (Slip x Slip)	EA	50
5-412	1/2" "P" Trap (Slip x Slip)	EA	100
5-414	3/4" "J" Trap (Slip x Slip)	EA	100

**90 Ell Reducing (Slip x FIPT)**

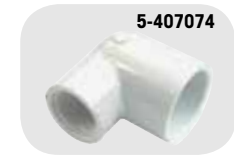

CATALOG NO.	DESCRIPTION	UOM	ORDER MULTIPLE
5-407074	1/2" x 3/4" 90 Ell Reducing	EA	50
5-407101	3/4" x 1/2" 90 Ell Reducing	EA	50
5-407130	1" x 1/2" 90 Ell Reducing	EA	50
5-407131	1" x 3/4" 90 Ell Reducing	EA	50

**90 Ell Reducing (Slip x Slip)**



CATALOG NO.	DESCRIPTION	UOM	ORDER MULTIPLE
5-406101	3/4" x 1/2" 90 Ell Reducing	EA	50
5-406130	1" x 1/2" 90 Ell Reducing	EA	50
5-406131	1" x 3/4" 90 Ell Reducing	EA	50

**90 Ell (FIPT x FIPT)**



CATALOG NO.	DESCRIPTION	UOM	ORDER MULTIPLE
5-408007	90 Ell (FIPT x FIPT)	EA	50

**90 Ell (Slip x FIPT)**



CATALOG NO.	DESCRIPTION	UOM	ORDER MULTIPLE
5-407005	1/2" 90 Ell	EA	50
5-407007	3/4" 90 Ell	EA	50
5-407015	1-1/2" 90 Ell	EA	25
5-407020	2" 90 Ell	EA	10
5-407025	2-1/2" 90 Ell	EA	10
5-407030	3" 90 Ell	EA	10

PVC SCHEDULE 40 PRESSURE FITTINGS cont'd

90 Street Ell (SPIG x Slip)



CATALOG NO.	DESCRIPTION	UOM	ORDER MULTIPLE
5-409005	1/2" 90 Street Ell	EA	50
5-409007	3/4" 90 Street Ell	EA	50
5-409010	1" 90 Street Ell	EA	50
5-409012	1-1/4" 90 Street Ell	EA	25
5-409015	1-1/2" 90 Street Ell	EA	25
5-409020	2" 90 Street Ell	EA	10

Plug (Slip)



CATALOG NO.	DESCRIPTION	UOM	ORDER MULTIPLE
5-449005	1/2" Plug	EA	50
5-449007	3/4" Plug	EA	50
5-449010	1" Plug	EA	50
5-449030	3" Plug	EA	10

90 Street Ell (MIPT x Slip)



CATALOG NO.	DESCRIPTION	UOM	ORDER MULTIPLE
5-410005	1/2" 90 Street Ell	EA	50
5-410007	3/4" 90 Street Ell	EA	50
5-410010	1" 90 Street Ell	EA	50

Cross (Slip x Slip x Slip x Slip)



CATALOG NO.	DESCRIPTION	UOM	ORDER MULTIPLE
5-420007	Cross (Slip x Slip x Slip x Slip)	EA	50

Reducing Bushing (MIPT X FIPT)



CATALOG NO.	DESCRIPTION	UOM	ORDER MULTIPLE
5-439131	Reducing Bushing 1" MIPT x 3/4"	EA	100

45 Ell (Slip x Slip)

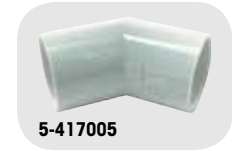

CATALOG NO.	DESCRIPTION	UOM	ORDER MULTIPLE
5-417005	1/2" 45 Ell	EA	50
5-417007	3/4" 45 Ell	EA	50
5-417010	1" 45 Ell	EA	50
5-417012	1-1/4" 45 Ell	EA	25
5-417020	2" 45 Ell	EA	25
5-417025	2-1/2" 45 Ell	EA	10
5-417030	3" 45 Ell	EA	10

Coupling (Slip x Slip)



CATALOG NO.	DESCRIPTION	UOM	ORDER MULTIPLE
5-429005	1/2" Coupling	EA	100
5-429007	3/4" Coupling	EA	50
5-429010	1" Coupling	EA	50
5-429012	1-1/4" Coupling	EA	25
5-429015	1-1/2" Coupling	EA	25
5-429020	2" Coupling	EA	25
5-429025	2-1/2" Coupling	EA	10
5-429030	3" Coupling	EA	10

### Female Adapter (Slip x FIPT)



CATALOG NO.	DESCRIPTION	UOM	ORDER MULTIPLE
5-435005	1/2" Female Adapter	EA	100
5-435007	3/4" Female Adapter	EA	50
5-435010	1" Female Adapter	EA	50
5-435012	1-1/4" Female Adapter	EA	25
5-435020	2" Female Adapter	EA	25
5-435030	3" Female Adapter	EA	10

### Male Adapter (MIPT x Slip)



CATALOG NO.	DESCRIPTION	UOM	ORDER MULTIPLE
5-436005	1/2" Male Adapter	EA	100
5-436007	3/4" Male Adapter	EA	50
5-436010	1" Male Adapter	EA	50
5-436020	2" Male Adapter	EA	25
5-436030	3" Male Adapter	EA	10

### Female Adapter Reducing (Slip x FIPT)



CATALOG NO.	DESCRIPTION	UOM	ORDER MULTIPLE
5-435074	1/2" x 3/4" Female Adapter Reducing	EA	50
5-435101	3/4" x 1/2" Female Adapter Reducing	EA	50
5-435102	3/4" x 1" Female Adapter Reducing	EA	50
5-435131	1" x 3/4" Female Adapter Reducing	EA	50

### Plug (MIPT)



CATALOG NO.	DESCRIPTION	UOM	ORDER MULTIPLE
5-450007	3/4" Plug	EA	50
5-450010	1" Plug	EA	50
5-450015	1-1/2" Plug	EA	25
5-450020	2" Plug	EA	10
5-450030	3" Plug	EA	10

### Male Adapter Reducing (MIPT x Slip)



CATALOG NO.	DESCRIPTION	UOM	ORDER MULTIPLE
5-436074	1/2" x 3/4" Male Adapter Reducing	EA	50
5-436101	3/4" x 1/2" Male Adapter Reducing	EA	50
5-436102	3/4" x 1" Male Adapter Reducing	EA	50
5-436131	1" x 3/4" Male Adapter Reducing	EA	50

### Reducer Bushing (SPIG x Slip)



CATALOG NO.	DESCRIPTION	UOM	ORDER MULTIPLE
5-437101	3/4" x 1/2" Reducer Bushing	EA	100
5-437130	1" x 1/2" Reducer Bushing	EA	100
5-437131	1" x 3/4" Reducer Bushing	EA	100
5-437210	1-1/2" x 3/4" Reducer Bushing	EA	25
5-437251	2" x 1-1/2" Reducer Bushing	EA	10
5-437339	3" x 2-1/2" Reducer Bushing	EA	10

### Reducer Bushing (SPIG X FIPT)



CATALOG NO.	DESCRIPTION	UOM	ORDER MULTIPLE
5-438101	3/4" x 1/2" Reducer Bushing	EA	100
5-438130	1" x 1/2" Reducer Bushing	EA	100
5-438131	1" x 3/4" Reducer Bushing	EA	100

### Cap (FIPT)



CATALOG NO.	DESCRIPTION	UOM	ORDER MULTIPLE
5-448005	1/2" Cap	EA	100
5-448007	3/4" Cap	EA	100
5-448010	1" Cap	EA	50

PVC SCHEDULE 40 PRESSURE FITTINGS cont'd

Adapter (Insert x Slip)



5-474007

CATALOG NO.	DESCRIPTION	UOM	ORDER MULTIPLE
5-474007	3/4" Adapter (Insert x Slip)	EA	50

3/4" Rubber Elbow

Allows for quick disconnect and reconnect of drain lines. Made of 60 DURO EPDM.



5-520

CATALOG NO.	DESCRIPTION	UOM	ORDER MULTIPLE
5-520	3/4" Rubber Elbows	EA	50

Clean Out Tee



510-3400

CATALOG NO.	DESCRIPTION	UOM	ORDER MULTIPLE
510-3400-10	3/4" Clean Out Tee	EA	10
510-3400	3/4" Clean Out Tee	EA	50

SUPPORTS

Plastic DWV J-Hooks



515-J2000

CATALOG NO.	DESCRIPTION	UOM	ORDER MULTIPLE
515-J2000	2" x 9" DWV Swiveling J-Hook	EA	25
515-J3000	3" x 7-1/2" DWV Swiveling J-Hook	EA	25

TUBING, CLAMPS, AND KITS

Polyethylene Tubing

F.D.A. approved, flexible, non-toxic tubing. Tasteless and odorless, lightweight, low density. Ideal for drinking water lines, evaporative coolers, and radiant heating. I.D.: 11/64", O.D.: 1/4", Wall: 0.040, Max. W/P (in.) 150 PSI @ 70F.



PE-104

CATALOG NO.	DESCRIPTION	UOM	ORDER MULTIPLE
PE-104	Polyethylene Tubing, 100'	EA	1

Hose Clamps

Partial stainless, worm drive, adjustable. 300 series stainless steel 1/2" band with plated 5/16" slotted hex head screw and housing, except the B-4H which has a 5/16" band and 1/4" nut. Recommended for most applications. 100% interlock construction features one-piece housing which directly locks into band. Spot weld free design.



B-4H

CATALOG NO.	DESCRIPTION	UOM	ORDER MULTIPLE
B-4H	No. 4, 7/32" - 5/8" dia., 3/16" - 5/16" hose I.D.	EA	10
B-6H	No. 6, 3/8" - 7/8" dia., 1/4" - 3/8" hose I.D.	EA	10
B-8H	No. 8, 7/16" - 1" dia., 5/16" - 1/2" hose I.D.	EA	10
B-10H	No. 10, 9/16" - 1-1/16" dia., 3/8" - 5/8" hose I.D.	EA	10
B-12H	No. 12, 9/16" - 1-1/4" dia., 5/8" - 3/4" hose I.D.	EA	10
B-16H	No. 16, 11/16" - 1-1/2" dia., 3/4" - 1" hose I.D.	EA	10
B-20H	No. 20, 3/4" - 1-3/4" dia., 1" - 1-1/4" hose I.D.	EA	10
B-24H	No. 24, 1-1/16" - 2" dia., 1-1/4" - 1-1/2" hose I.D.	EA	10
B-28H	No. 28, 1-5/16" - 2-1/4" dia., 1-1/4" - 1-3/4" hose I.D.	EA	10
B-32H	No. 32, 1-9/16" - 2-1/2" dia., 1-1/2" - 2" hose I.D.	EA	10
B-36H	No. 36, 1-13/16" - 2-3/4" dia., 1-3/4" - 2-1/4" hose I.D.	EA	10



### Icemaker Kit

Supplies water to most refrigerators with automatic icemakers, humidifiers and evaporative coolers. Contains self-tapping valve and all necessary fittings.



750-402

CATALOG NO.	DESCRIPTION	UOM	ORDER MULTIPLE
750-401	Icemaker Kit – Poly Tube – 25'	EA	1
750-402	Icemaker Kit – Copper – 25'	EA	1

### Self Tapping Water Valve

Installs on all copper tube lines from 3/8" O.D. to 1-1/8" O.D. without shutting off water. No drilling required. Features 1/4" compression fitting. Stainless steel piercing needle. Special molded gasket seals on both tubing and valve. Will not slip or turn on tubing.



QAV-2

CATALOG NO.	DESCRIPTION	UOM	ORDER MULTIPLE
QAV-2	Self Tapping Water Tap Valve	EA	1

# one purchase order. **multiple advantages.**

Save **TIME**, **EFFORT** and **MONEY** With Consolidated Purchasing.



- Thousands of SKUs
- Installation and Maintenance Parts & Services
- Equipment Pads, Chemicals and Accessories

**DIVERSiTECH** 

800.995.2222  
WWW.DIVERSITECH.COM

# DUCTLESS SYSTEMS

SpeediChannel™ Line Set Cover System .....	203
Equipment Support Systems.....	203
Fittings.....	203-206
Roof Inlets.....	206



# Hef-T-Frame™

## INSTALLATION



Step 1



Step 4



Step 2



Step 5



Step 3

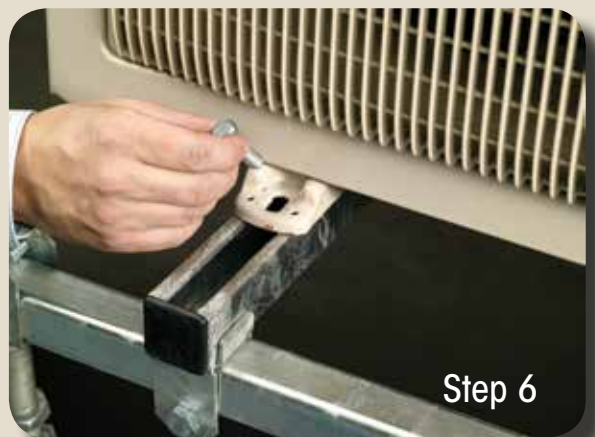

Step 6



Condensate management is needed for heat pumps.

*Hef-T-Frame™ — Utility Room Installation, Gravity Drain*



*Hef-T-Frame™ — Utility Room Installation, Condensate Pump*

# Hef-T-Foot™

*Recycled rubber condensing unit and accessory mounting blocks.*



## ROOFTOP INSTALLATIONS



*Hef-T-Foot™ —  
Rooftop/Ground Mount  
Installation*



*Hef-T-Foot™ —  
Rooftop/Ground Mount  
Accessory/Pipe Support  
Installation*

**UTILITY ROOM INSTALLATIONS**



*Hef-T-Foot™ —  
Utility Room Installation,  
Gravity Drain*

**Condensate  
management  
is needed for  
heat pumps.**



*Hef-T-Foot™ —  
Utility Room Installation,  
Condensate Pump*

**Hef-T-Bracket™ — Wall Mounted Mini-Split Brackets**



**HEF-T-BRACKET™ TYPE 2**  
These brackets feature a cross bar that is attached to a wall and two L-shaped brackets that are hooked and bolted into place on the cross bar.



When operating in heat pump mode, the unit will produce condensate which is easily captured and managed using this snap on drain pan.

# SpeediChannel™ Line Set Cover System

DiversiTech SpeediChannel™ is an innovative channel system used to cover air conditioning line sets. The two part system has a base and a cover. The base is fastened to a wall or ceiling, then a clever little plastic clip (SpeediClip™) snaps into a channel already molded into the base. Then, using standard cable ties, the line set, cables, control wires, and/or condensate drain line are fastened in place. The cover then snaps simply on top of the base.



The SpeediChannel™ system is available in three widths – 3”, 4”, and 6”. Each piece of SpeediChannel™ is 6-1/2 feet long. A complete line of couplings, elbows, and tees are available for the SpeediChannel™ system.

Manufactured from rigid PVC, the SpeediChannel™ system is a natural color that is a very close match to the typical mini-split condensing unit case. However, the SpeediChannel™ system can be painted as desired to match any wall color. Use paint made for plastic only. The PVC used in the SpeediChannel™ system is resistant to UV light and is UL rated.



DiversiTech recommends attaching the base to the wall or ceiling and the line sets to the system every 15” to allow for the system to carry the full weight of the line sets.

*The SpeediChannel™ can also be used inside.*





*Cut your installation time!  
SpeediClip™— fastest  
SpeediChannel™  
installation.*



# DiversiTech SpeediChannel™ System

## SIZING CHART AND SELECTION INFORMATION

Maximum Line Set, Drain Pipe, and Cable Capacity using 3/8" Insulation

Model	230-D3	230-D4	230-D6
Dimensions	3" x 2-1/2"	4" x 2-3/4"	6" x 3"
Length	78"	78"	78"

Mini-Split Systems – Liquid and Suction Line with 3/8" Insulation

Liquid Line	3/8"	2 x 1/4"	1 x 1/4" + 2 x 3/8"
Suction Line	5/8"	2 x 3/8"	1 x 1/2" + 2 x 5/8"
Drain Hose	3/4" OD	2 x 3/4" OD	3 x 3/4" OD
Power Cable	1 x UF 14-3	2 x 1/2" SealTite	3 x 1/2" SealTite
Control Cable	1 Pair 18 AWG	2 Pairs 18 AWG	3 Pairs 18 AWG
Nominal Tonnage	1–3 Tons	1x3 Ton or 2x1 Ton	1x3 Ton or 2x2 Ton

Conventional Split Systems – Liquid Line Plain, Suction Line with 3/8" Insulation

Liquid Line	3/8"	3/8"	3/8"
Suction Line	3/4" or 7/8"	1-1/8"	1-1/8"
Drain Hose	3/4" PVC	3/4" PVC	3/4" PVC
Power Cable	1 x UF 14-2	1 x 1/2" SealTite	1 x 1/2" SealTite
Control Cable	1 Pair 18 AWG	1 Pair 18 AWG	1 Pair 18 AWG
Nominal Tonnage	Up to 3.5 Tons	4–5 Tons	7.5 Tons and up

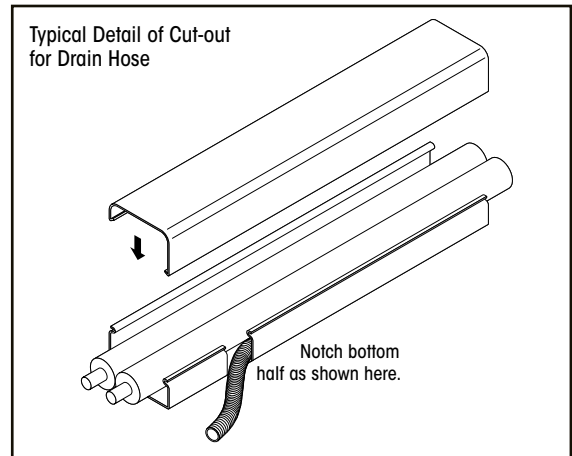
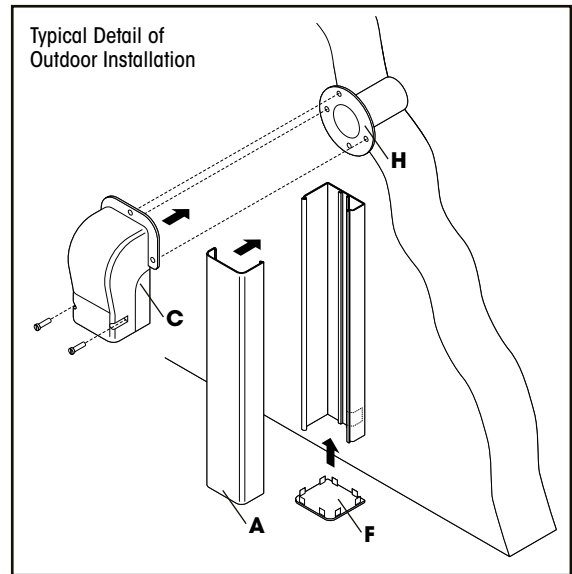
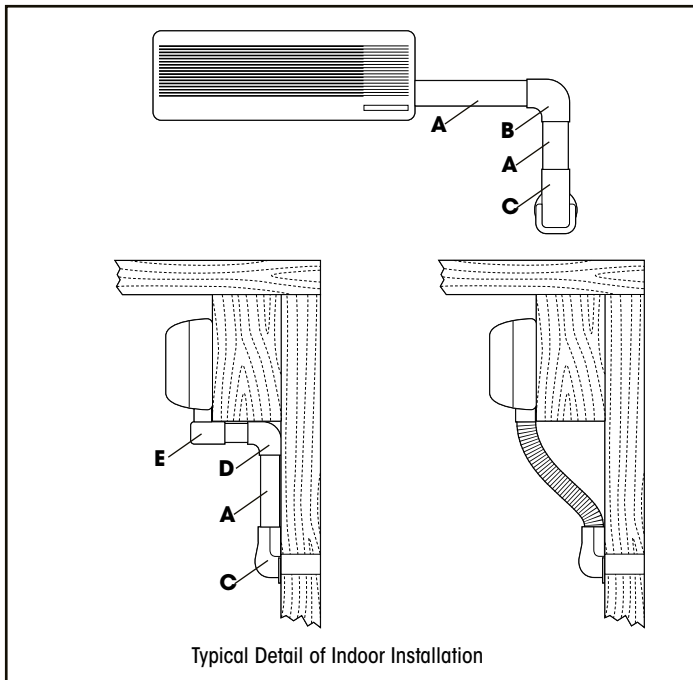

- A - 230-D
- B - 230-FB
- C - 230-WC
- D - 230-EB
- E - 230-EIN
- F - 230-DC
- G - 230-FJ
- H - 230-WS2

NOTE:  
Suffix parts A-G  
with the duct  
size needed  
(3,4, or 6)

Typical Detail of Flex Joint Application

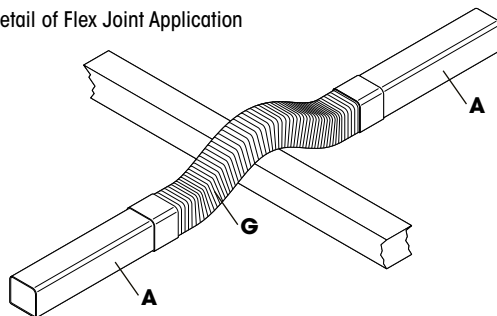

# DiversiTech SpeediChannel™ System

## TECHNICAL SPECIFICATIONS

Color	Natural			
Size	230-D3: 3" x 2-1/2" OD	230-D4: 4" x 2-3/4" OD	230-D6: 6" x 3-1/8" OD	Standard Length: 78"
Material	Weather Resistant PVC, UV Stabilized and Fire Resistant			
Fire Rating	Meets UL 94V-0			
Temperature Range	-4°F TO 140°F			
Weather Resistance	Tested to over 2,000 hours			
Fixing Screws	Stainless Steel			

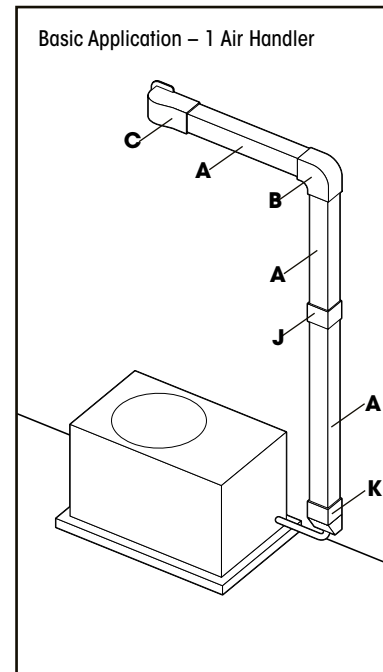
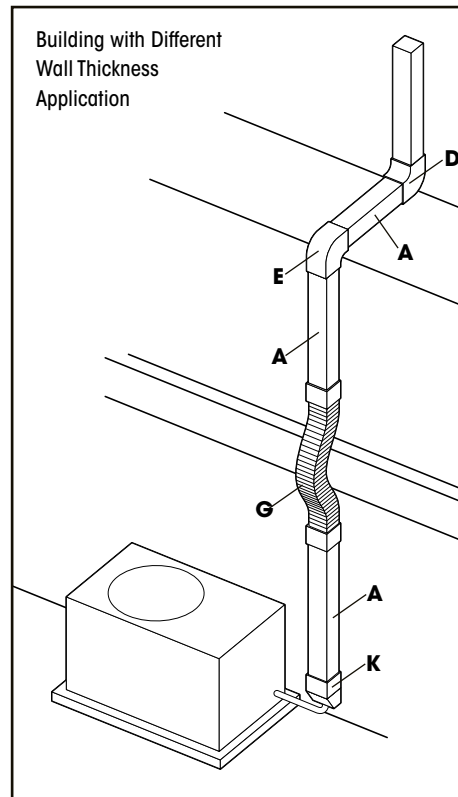
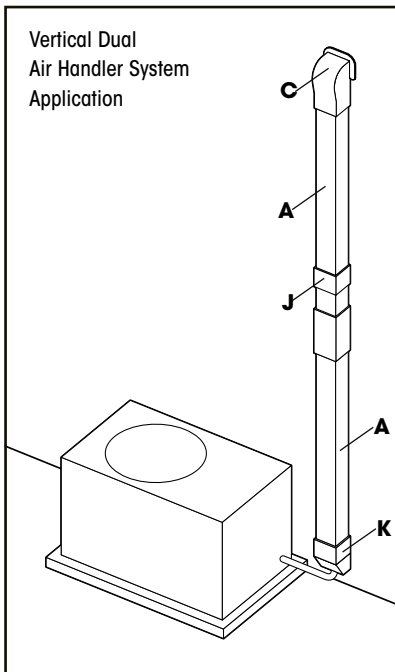
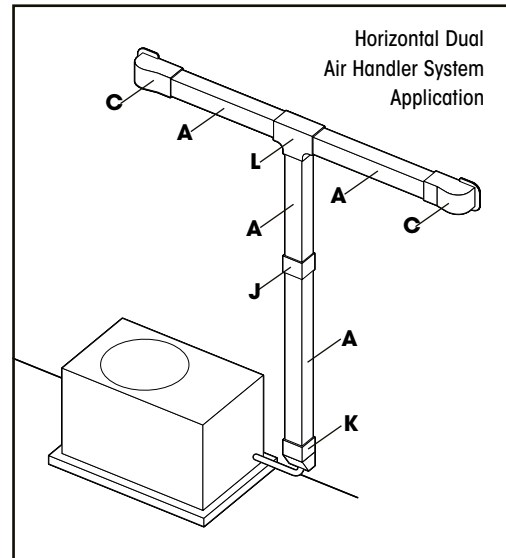
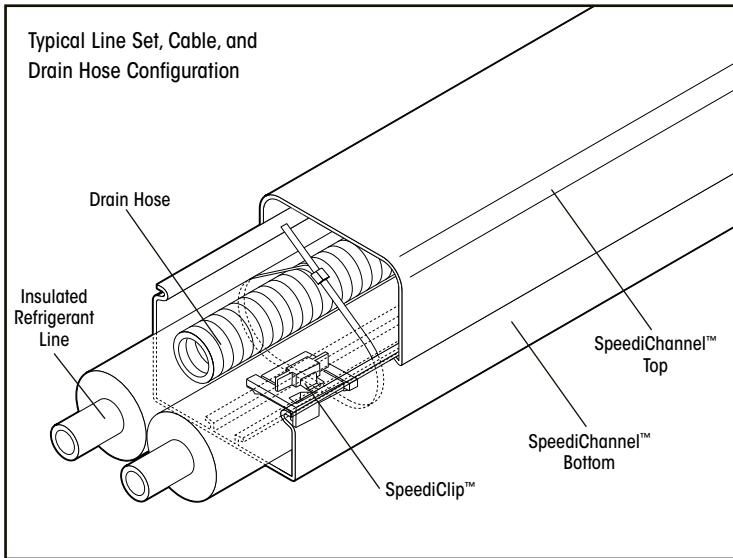

- A - 230-D
- B - 230-FB
- C - 230-WC
- D - 230-EB
- E - 230-EIN
- F - 230-DC
- G - 230-FJ
- H - 230-WS2
- J - 230-CP
- K - 230-DE
- L - 230-TC

NOTE:  
Suffix parts A-G  
with the duct  
size needed  
(3, 4, or 6)

# SpeediChannel™ System Installation

## Step 1

Attach the SpeediChannel™ base to the wall about every 15 inches with screws suitable for the wall construction (siding, stucco, brick, etc.). Screw through the center of the molded rail. Slide the connecting piece (elbow, union, tee, etc.) under the SpeediChannel™ before attaching the end of the channel to the wall. When cutting lengths of SpeediChannel™, allow 1/8" gap between the end of the SpeediChannel™ and the stop inside the fitting to allow for thermal expansion.



## Step 4

Attach the SpeediChannel™ to the base.



## Step 2

Attach one SpeediClip™ with cable tie about every 20 inches along the inside sliding rail.



## Step 5

Attach the fitting covers with the screws provided.



## Step 3

Install the line set, drain line, and wires inside the SpeediChannel™. Test the equipment installation prior to tightening the cable ties. Tighten the cable ties snug, but not so tight they damage the tubing insulation or kink the drain line. Trim excess length from the cable tie.



## Step 6

When complete, paint the SpeediChannel™ to match surface of installation (if desired).



## SPEEDICHANNEL™ LINE SET COVER SYSTEM

### SpeediChannel™

The DiversiTech SpeediChannel™ is available in three widths, all in 6-1/2 feet lengths. Includes pack of SpeediClips™.

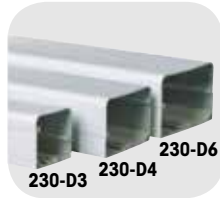

CATALOG NO.	DESCRIPTION	UOM	ORDER MULTIPLE
<b>230-D3</b>	3" SpeediChannel™	EA	6
<b>230-D4</b>	4" SpeediChannel™	EA	6
<b>230-D6</b>	6" SpeediChannel™	EA	5

Channel must ship LTL.

## EQUIPMENT SUPPORT SYSTEMS

### Hef-T-Frame™

The flexibility of the Hef-T-Frame™ means that "designing" is simple. The design consists of a Hef-T-Frame™ Base and a Hef-T-Frame™ Extender which combine to provide a solution for mounting any type of equipment. Simply start with a Hef-T-Frame™ Base and add the required number of Hef-T-Frame™ Extenders to create your own system. Hef-T-Frame™ Extenders can be added in any direction to make a system of any size in multiples of 4'. Each frame has a maximum dimension of 4'. Each Hef-T-Frame™ Base and Hef-T-Frame™ Extender is capable of supporting 1,100 lbs. safe working load. Be sure the underlying roof structure can support the weight of the equipment and frame system. Each frame weighs 66 lbs. (Hef-T-Frame™ Base) and 53 lbs. (Hef-T-Frame™ Extender).



CATALOG NO.	DESCRIPTION	UOM	ORDER MULTIPLE
<b>PH-BF</b>	Hef-T-Frame™ Base	EA	1
<b>PH-EF</b>	Hef-T-Frame™ Extender	EA	1

### Hef-T-Foot™

The Hef-T-Foot™ is used to support small pipework, runs of cable tray, or an alternative to supporting condensing units, air source heat pumps or a variety of outdoor equipment. The Hef-T-Foot™ with strut comes in four lengths — 9.8", 15.7", 23.6", 39.4". They are manufactured from heavy duty recycled rubber and come complete with .8" x 1.6" galvanized steel strut adhered to the rubber with industrial adhesive. The rubber is strong and durable with drain slots moulded into the underside to allow standing water to flow under the foot.



CATALOG NO.	DESCRIPTION	UOM	ORDER MULTIPLE
<b>FF-250-S</b>	Hef-T-Foot™ – 9.8" with 1.6" x .8" strut	EA	1
<b>FF-400-S</b>	Hef-T-Foot™ – 15.7" with 1.6" x .8" strut	EA	1
<b>FF-600-S</b>	Hef-T-Foot™ – 23.6" with 1.6" x .8" strut	EA	1
<b>FF-1000-S</b>	Hef-T-Foot™ – 39.4" with 1.6" x .8" strut	EA	1
<b>FF-250-UNI</b>	Hef-T-Foot™ – 9.8" Universal	EA	1

### Hef-T-Foot™ Installation Variants



## FITTINGS

### Adjustable Flat Bend

Adjustable flat bends flex from 45 to 90 degrees and make it easy to route the SpeediChannel™ around an obstacle. Each adjustable bend is individually packed and includes stainless steel screws.



CATALOG NO.	DESCRIPTION	ORDER UOM	ORDER MULTIPLE
<b>230-AFB3</b>	3in. Adjustable Flat Bend	EA	10
<b>230-AFB4</b>	4in. Adjustable Flat Bend	EA	10

### Soffit Fittings

Ideal for outdoor applications where the SpeediChannel™ runs up an exterior wall and enters the house vertically through the soffit. Its large flat surface area easily covers the rough opening cut in the soffit. Furnished in two parts, the Soffit Fitting easily snaps onto the SpeediChannel™ for a clean installation.



CATALOG NO.	DESCRIPTION	ORDER UOM	ORDER MULTIPLE
<b>230-SF3</b>	3" Soffit Fitting	EA	10
<b>230-SF4</b>	4" Soffit Fitting	EA	10

**FITTINGS cont'd**

**Wall Penetration**

Wall sleeves and penetration covers are used to transition from the SpeediChannel™ system to a through wall penetration. The wall sleeve creates a neat hole through the wall, and the line set is covered by the wall cover. DiversiTech's wall covers are designed to allow for easy installation - even after the line set has been installed. A unique hooking and fastening arrangement allows for quick and easy installation. Each wall cover is individually packed, and is furnished complete with stainless steel screws to attach the wall cover to the base. Three screws (supplied by others) are needed to fasten the wall cover to whatever type of wall construction the system is being installed on.



CATALOG NO.	DESCRIPTION	UOM	ORDER MULTIPLE
<b>230-WC3</b>	3" Wall Penetration Cover	EA	10
<b>230-WC4</b>	4" Wall Penetration Cover	EA	10
<b>230-WC6</b>	6" Wall Penetration Cover	EA	10
<b>230-WS2</b>	2-1/2" Wall Sleeve	EA	10

**90° Long Radius Bend**

90° long radius flat bends are used to route the SpeediChannel™ around an obstacle. The long radius of the elbow allows a gentle bending radius on the copper line set. Each elbow is individually packed, and is furnished complete with stainless steel screws.



CATALOG NO.	DESCRIPTION	UOM	ORDER MULTIPLE
<b>230-LFB3</b>	3" 90 deg Long Radius Bend	EA	10
<b>230-LFB4</b>	4" 90 deg Long Radius Bend	EA	10
<b>230-LFB6</b>	6" 90 deg Long Radius Bend	EA	10

**90° Inside Elbow**

90° inside elbows are used to route the SpeediChannel™ around an inside corner. Each elbow is individually packed, and is furnished complete with stainless steel screws.



CATALOG NO.	DESCRIPTION	UOM	ORDER MULTIPLE
<b>230-EB3</b>	3" 90 degree Inside Elbow	EA	10
<b>230-EB4</b>	4" 90 degree Inside Elbow	EA	10
<b>230-EB6</b>	6" 90 degree Inside Elbow	EA	10

**90° Flat Bend**

90° flat bends are used to route the SpeediChannel™ around an obstacle. Each bend is individually packed, and is furnished complete with stainless steel screws.



CATALOG NO.	DESCRIPTION	UOM	ORDER MULTIPLE
<b>230-FB3</b>	3" 90 deg Flat Bend	EA	10
<b>230-FB4</b>	4" 90 deg Flat Bend	EA	10
<b>230-FB6</b>	6" 90 deg Flat Bend	EA	10

**45° Flat Bend**

45° flat bends are used to route the SpeediChannel™ around an obstacle. Each bend is individually packed, and is furnished complete with stainless steel screws.



CATALOG NO.	DESCRIPTION	UOM	ORDER MULTIPLE
<b>230-FB453</b>	3" 45 degree Flat Bend	EA	10
<b>230-FB454</b>	4" 45 degree Flat Bend	EA	10
<b>230-FB456</b>	6" 45 degree Flat Bend	EA	10

**90° Outside Elbow**

90° outside elbows are used to route the SpeediChannel™ around an outside corner. Each elbow is individually packed, and is furnished complete with stainless steel screws.



CATALOG NO.	DESCRIPTION	UOM	ORDER MULTIPLE
<b>230-EIN3</b>	3" 90 degree Outside Elbow	EA	10
<b>230-EIN4</b>	4" 90 degree Outside Elbow	EA	10
<b>230-EIN6</b>	6" 90 degree Outside Elbow	EA	10

**FITTINGS cont'd**

**Union Coupling**

Used for joining two pieces of SpeediChannel™ — each cover being the same size. Each coupling is individually packed, and is furnished complete with stainless steel screws.



CATALOG NO.	DESCRIPTION	UOM	ORDER MULTIPLE
<b>230-CP3</b>	3" Union Coupling	EA	10
<b>230-CP4</b>	4" Union Coupling	EA	10
<b>230-CP6</b>	6" Union Coupling	EA	10

**Flex Joint**

An accordion style piece of SpeediChannel™, the flex joint can be extremely flexible routing a SpeediChannel™ system around virtually any type of obstacle. Each joint is 20" long and can be combined together for longer flex runs. Unlike competitor systems, the DiversiTech flex joint does NOT require the use of a union coupling. The DiversiTech flex joint slides tightly inside the SpeediChannel™ system.

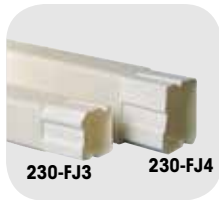

CATALOG NO.	DESCRIPTION	UOM	ORDER MULTIPLE
<b>230-FJ3</b>	3" Flex Joint	EA	10
<b>230-FJ4</b>	4" Flex Joint	EA	10

**Duct End**

The duct end is used to terminate a run of SpeediChannel™ to a small opening — just large enough for the line set and condensate drain line to pass through. Gives a neat/clean installation.



CATALOG NO.	DESCRIPTION	UOM	ORDER MULTIPLE
<b>230-DE3</b>	3" Duct End	EA	10
<b>230-DE4</b>	4" Duct End	EA	10
<b>230-DE6</b>	6" Duct End	EA	10

**T-Joint**

Used for creating a tee connection between three pieces of SpeediChannel™ — all covers being the same size. The tee can be combined with the reducing coupling to join SpeediChannel™s of different sizes. Each tee is individually packed, and is furnished complete with stainless steel screws.



CATALOG NO.	DESCRIPTION	UOM	ORDER MULTIPLE
<b>230-TJ4</b>	4" T-Joint	EA	10
<b>230-TJ6</b>	6" T-Joint	EA	10

**Reducer Coupling**

Used for joining two pieces of SpeediChannel™ — each cover being a different size. Each coupling is individually packed, and is furnished complete with stainless steel screws.



CATALOG NO.	DESCRIPTION	UOM	ORDER MULTIPLE
<b>230-TC34</b>	3" x 4" Reducer Coupling	EA	10
<b>230-TC46</b>	4" x 6" Reducer Coupling	EA	10

**Cap**

Used to cap the end of a SpeediChannel™ run. Easily snaps into the end of the SpeediChannel™.



CATALOG NO.	DESCRIPTION	UOM	ORDER MULTIPLE
<b>230-DC3</b>	3" Cap	EA	10
<b>230-DC4</b>	4" Cap	EA	10
<b>230-DC6</b>	6" Cap	EA	10

**FITTINGS cont'd**

**Flat Wall Escutcheon**

Typically used to cover a rough opening in a soffit, wall, or ceiling penetration. One side of the escutcheon is flat to allow for a SpeediChannel™ run going along a wall, and penetrating through an adjacent wall or ceiling. This is the most common type of wall penetration. Furnished in two parts, the escutcheon easily snaps onto the SpeediChannel™.



CATALOG NO.	DESCRIPTION	UOM	ORDER MULTIPLE
<b>230-FR3</b>	3" Flat Wall Escutcheon	EA	10
<b>230-FR4</b>	4" Flat Wall Escutcheon	EA	10
<b>230-FR6</b>	6" Flat Wall Escutcheon	EA	10

**Wall Escutcheon**

Typically used to cover a rough opening in a wall or ceiling penetration. The hole in the escutcheon is centered to allow for a free standing SpeediChannel™ to penetrate through a wall or ceiling. This is the fairly un-common type of wall or ceiling penetration. Check carefully, as you may need the Flat Wall Escutcheon. Furnished in two parts, the escutcheon easily snaps onto the SpeediChannel™.



CATALOG NO.	DESCRIPTION	UOM	ORDER MULTIPLE
<b>230-WR3</b>	3" Wall Escutcheon	EA	10
<b>230-WR4</b>	4" Wall Escutcheon	EA	10
<b>230-WR6</b>	6" Wall Escutcheon	EA	10

**SpeediChannel™ Accessories**

A variety of accessories that are complementary or required for installing DiversiTech's SpeediChannel™ system.



CATALOG NO.	DESCRIPTION	UOM	ORDER MULTIPLE
<b>230-DCLIP-10</b>	SpeediClip™ and 11" Cable Ties, pack of 10	PK	1
<b>230-DCLIP</b>	*SpeediClip™, pack of 50	PK	1
<b>230-DSCREW</b>	SpeediChannel™ screws, pack of 100	PK	1
<b>WTB11C</b>	Black Wire Ties – 11", pack of 100	PK	1

\*Sold Separately.

**SpeediChannel™ Fitting Kit**

The SpeediChannel™ Fitting Kit provides a simple mix of the basic fittings used in a typical SpeediChannel™ installation job. Included are one coupling, one wall penetration, one inside elbow, one long radius flat bend, and one pack of ten SpeediClips and 11" cable ties. Two kits are available – one for 3" channel and one for 4" channel.



CATALOG NO.	DESCRIPTION	UOM	ORDER MULTIPLE
<b>230-IK3</b>	3" SpeediChannel™ Fitting Kit	EA	1
<b>230-IK4</b>	4" SpeediChannel™ Fitting Kit	EA	1

**ROOF INLETS**

**Roof Inlets**

"Roof entrance" adapters for linesets are the ultimate solution for a professional flat roof installation. Manufactured from UV weather resistant plastics, the Roof Inlet combines a series of features:

- the Roof Inlet body part is equipped with a slope avoiding possible damage to the insulation and preventing kinks into the copper tubes.
- the Roof Inlet base holes allow a steady fixation (depending on the roof surface type and composition).
- the Roof Inlet cap is firmly fixed to the body with stainless steel bolts.



CATALOG NO.	DESCRIPTION	UOM	ORDER MULTIPLE
<b>230-INJ465</b>	SpeediChannel™ Roof Inlet – 5"	EA	2
<b>230-INJ462</b>	SpeediChannel™ Roof Inlet – 10"	EA	2



# MAINTENANCE CHEMICALS

Accessories .....	223-224
Additives .....	233
Air Filter Products .....	224
Coil Cleaners .....	222-223
Coil Cleaning Aerosols .....	224
Drain Pan Disinfectant, Sealant .....	224
Flushing Products .....	225
Glycols .....	225-226
Heating Products .....	226
Hoses, Sprayers .....	227
Ice Machine Products .....	228
Leak Detectors .....	228
Odor Neutralizers .....	228
Pan Treatments .....	229
Pan Treatments/Disinfectants .....	229-230
Refrigeration Oils .....	230-231
System Cleaners .....	231
Test Kits, Strips, and Prevention .....	231
Thread Sealants .....	232
Vacuum Pump Oil .....	232



# Triple-D™ Universal Coil Cleaner™

Triple-D™ is a Universal Coil Cleaner™ suitable for use on condenser and evaporator coils. It is metal safe and does not attack aluminum or copper coil components, extending equipment life and diminishing potential for refrigerant leaks. Triple-D™ is a safer, more versatile product than conventional acid or non-acid coil cleaners. One product does it all — truly a Universal Coil Cleaner™.

FEATURES	BENEFITS
<i>Universal Coil Cleaner™</i>	One product for multiple applications reduces inventory and eliminates potential product mis-application.
<i>Metal Safe</i>	Conventional foaming acid coil cleaners actually attack and chemically react with the aluminum coil components. This reaction is exhibited by a foaming action. Conventional foaming non-acid coil cleaners are so strong (because they lack the unique inhibitor in Triple-D™) they also attack the aluminum coil components. The attack/reaction dissolves the aluminum, destroying the heat-transfer ability of the coil, and creates the potential for refrigerant leaks. Over time, the reduction in heat transfer ability for the coil increases energy consumption significantly.
<i>Super Concentrated</i>	Lower cost per mixed gallon. Triple-D™ is a 6:1 dilution ratio, making 7 gallons of usable product per gallon of concentrate.
<i>Multiple Packages/Forms</i>	Available as a concentrated liquid, pre-diluted liquid, aerosol, or Granular Coil Cleaner™. Same product — different packages.
<i>NSF Registered</i>	Assurance that Triple-D™ is safe as a cleaner in restaurants, hospitals, government institutions, and any food preparation area. Rinse thoroughly after use.
<i>Safe for Rubber Roofs</i>	Does not damage engineered polymeric or rubber roofing.
<i>Corrosion Inhibited</i>	Conventional foaming acid and non-acid coil cleaners actually attack and chemically react with the aluminum (and sometimes copper) coil components. This reaction is exhibited by a foaming action. The reaction dissolves the aluminum, destroying the heat-transfer ability of the coil, and creates the potential for refrigerant leaks.
<i>Biodegradable</i>	Triple-D™ is manufactured from chemicals that break down naturally in the environment. When a coil is cleaned, the rinse water is typically washed into the storm sewer.
<i>Non-Foaming</i>	Foaming of coil cleaners is exhibited when the cleaner chemically reacts with the aluminum (and sometimes the copper) coil components. This reaction is exhibited by a foaming action. The reaction dissolves the aluminum, destroying the heat-transfer ability of the coil, and creates the potential for refrigerant leaks. Additionally, foaming action on foaming coil cleaners is an exothermic (heat generating) chemical reaction. This heat is extreme and can damage coils.
<i>Non-Toxic</i>	Triple-D™ is manufactured from chemicals that break down naturally in the environment. When a coil is cleaned, the rinse water is typically washed into the storm sewer. Conventional acid coil cleaners contain dangerous hydrofluoric acid that is extremely toxic to humans and animals.
<i>Inhibited Non-Acid Formulation</i>	Triple-D™ contains a unique inhibitor that allows for a very strong alkaline (non-acid) formulation that effectively cleans coils. Other non-acid coil cleaners are either too weak to effectively clean a coil, or are so strong (and hence foaming) that they attack the aluminum coil.

**Aluminum Loss of Foaming Coil Cleaners vs. Triple-D™**

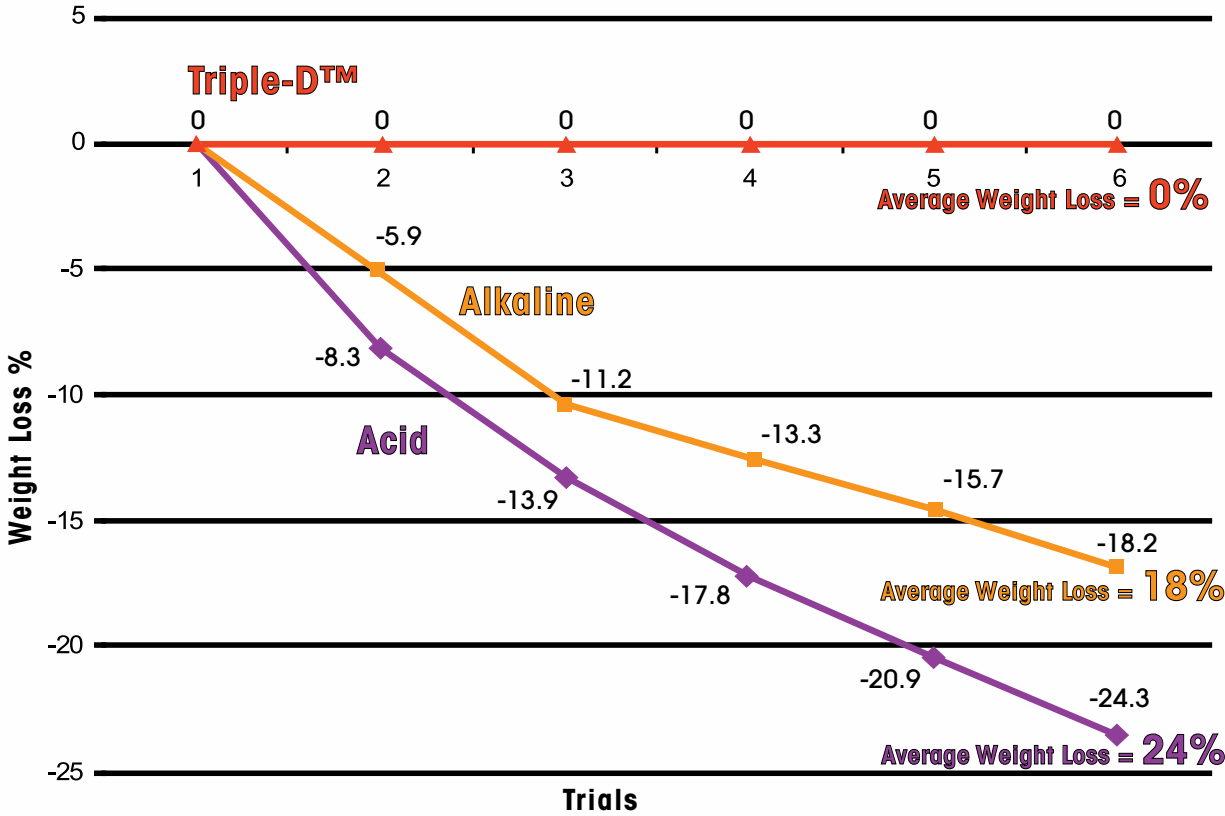

As shown above, conventional foaming acid coil cleaners and foaming non-acid coil cleaners actually attack and chemically react with the aluminum coil components. This reaction is exhibited by a foaming action. The attack/reaction dissolves the aluminum, destroying the heat-transfer ability of the coil and creating the potential for refrigerant leaks.



# LineSeal™ Refrigerant Line Sealant

LineSeal™ System Leak Sealant:

- stops refrigerant leaks
- prevents future leaks
- improves system performance



## LineSeal™ permanently seals system leaks in refrigerant lines.

**L**ineSeal™ is a fast, effective way to permanently seal system leaks in refrigerant lines. LineSeal™ stops existing leaks and remains in the system to prevent future leaks. It is compatible with all oils and refrigerants and will not contaminate the refrigerant.

### FIXES THE LEAKS FAST

Refrigerant leaks can cause cooling system failure, are costly, and bad for the environment. Stopping leaks is critical to effective system performance and satisfied customers. LineSeal™ is a self-contained, vacuum packed canister of sealant that is released into a refrigerant system. The sealant travels with the oil and refrigerant throughout the system. Where the system leaks, the refrigerant escapes and lowers the surrounding air temperature down to the dew point where micro droplets of water are deposited around the perimeter of the leak area. The sealant reacts with the droplets of water to harden into a protective barrier to keep refrigerant from escaping.

LineSeal™ that hasn't been used remains in the system as an inert component, ready to seal future leaks and provide years of protection for your system.

### NO PROPANE OR BUTANE PROPELLANTS

Unlike many sealant products, LineSeal™ uses no harmful hydrocarbon (propane or butane) chemicals, assuring that the system remains safe and contaminate free.

Propane and butane are used in some sealants and could potentially contaminate the refrigerant which is then technically a mixed gas that does not meet ARI purity standards. Once hydrocarbon (HC) gases are mixed with HFC or HCFC refrigerants, they are nearly impossible to remove. LineSeal™ vacuum-packed canister pulls refrigerant from the system to charge the canister and injects the sealant straight into the refrigerant line, so that no harmful propellants are needed.

LineSeal™ is designed for most residential systems and is compatible with CFC, HFC, HCFC refrigerants and mineral oil, alkylbenzene, and POE systems.



### OTHER FEATURES:



**Compatible with all oils and refrigerants**



**Designed for residential systems**



**Doesn't harm compressors or other components**



**New hose with each kit**



**No access valve clogging**



**Pressure relief valve**



# Pro-Flush™ HVAC Flushing Solvent

***Pro-Flush™ answers your need for a professional quality flushing solvent with the components to match.***

- Formulated for R-410A retrofits, refrigerant conversions and compressor burnouts
- Lower cost solution than competitive pre-charged kits
- Solvents are non-VOC, conform to EPA SNAP standards, and are non-HAZMAT
- Low toxicity and residue free
- Flash Point: No flash point to boiling (41°C/106°F) - TAG Closed Cup (per ASTM D-56)
- Kit includes reusable tank with a pressure relief valve for added safety, a hose, and an injector trigger nozzle
- Better delivery system



## FREQUENTLY ASKED QUESTIONS

**Q: What refrigerants is Pro-Flush™ compatible with?**

**A:** Pro-Flush™ is compatible with CFC and HFC refrigerants and compressor oils.

**Q: Is Pro-Flush™ safe to use?**

**A:** Pro-Flush™ is safe, nontoxic, and residue free. In addition, Pro-Flush™ conforms to EPA's Significant New Alternatives Program (SNAP) standards.

**Q: Is Pro-Flush™ HAZMAT?**

**A:** Pro-Flush™ is not HAZMAT for storage or ground transportation.

**Q: What is the advantage of the reusable injector tank?**

**A:**

1. The reusable tank lowers cost since you only need to buy the Pro-Flush™ refill cans.
2. Pre-charged cans include refrigerant propellants which are more expensive to use than nitrogen.
3. The trigger assembly allows for infinite control of dosage insuring more economical use of the solvent.
4. Using nitrogen as the propellant is less expensive and more environmentally friendly than using HFC-134A. HFC-134A is a powerful greenhouse gas. One kilogram of HFC-134A has the same global warming impact as 1,430 kilograms of carbon dioxide (<http://www.epa.gov/cpd/mac/service>).

**Q: Can the injector tank be over pressurized during nitrogen pressurization?**

**A:** Over pressurization is highly unlikely but possible. The injector valve has a reseating pressure relief safety valve set at 200 psi. This helps prevent potential bursting and resultant injury.

**Q: What if I don't require the entire can of Pro-Flush™ Solvent to clean a system or line set?**

**A:** The injection nozzle allows you to control the dose rate and any left over solvent can be stored in the injector for future use.

**Q: How does the dose rate for Pro-Flush™ for burnouts and retrofits compare with the competitors?**

**A:** For R22 to 410A conversions, we recommend 3-second bursts of solvent. A 16-ounce can of Pro-Flush™ will treat up to 500 feet of liquid line. For burnouts, we recommend 2-3 oz. per ton. Pro-Flush™ uses less solvent per application than Nu-Calgon. Treatment results will vary depending on the application and conditions of the line set when serviced.

**Q: Why do you recommend only charging the injector tank to 50psi, then injecting in 3 second bursts?**

**A:** Tests are conclusive that injecting the solvent at lower pressure assures longer solvent to oil contact time. In addition, the smaller volume delivered in short bursts assists in completely dissolving contaminants. In this case, less is better.

**Q: Is nitrogen necessary for use with Pro-Flush™?**

**A:** Nitrogen is used as the propellant for Pro-Flush™. Nitrogen is required with all flushing systems to purge any residual solvent and contaminants through the system.

**Q: Do pre-charged canister systems dispense 100% of the flushing solvent?**

**A:** In many cases pre-charged canister systems will not fully dispense the flushing solvent depending on temperature. At lower temperatures, the R-134a propellant provides less pressure and may leave solvent in the canister. The Pro-Flush™ system allows contractors to add additional nitrogen if there is still solvent left, regardless of temperature.



# Power Sprayer

*Stop pumping up your old sprayer and enjoy the freedom and speed of the DiversiTech Power Sprayer.*





*DiversiTech's Power Sprayer makes coil cleaning easier and faster than ever before. This new unit is designed as a backpack sprayer and holds up to 4 gallons of coil cleaning solution. The battery powered unit will spray continuously for 10 hours on a single charge. Included are three different nozzles to give you the right spray for any situation. Other features include padded backpack straps for a comfortable fit, plug-in charger for fast recharging, and a convenient center mount handle. The sprayer also comes with an extra long spray wand with curved tip for accurate application of cleaner and a large on/off valve which can lock in position for easier spraying of big jobs. The large tank opening also makes it easy to add coil cleaner and mix to the correct ratio. The Power Sprayer has been tested and is compatible with all DiversiTech coil cleaners.*



# HVAC Maintenance Chemical Comparison Chart



Product Name	Product Color	Product Description	Nu-Calgon
TRIPLE-D	amber <i>USDA</i>	Universal Coil Cleaner	NO EQUIVALENT
PRO-GREEN	green <i>USDA</i>	Alkaline Evaporator Coil and System Cleaner, Degreaser	Evap Pow'r-C
PRO-BLUE	blue	Maximum Foaming Alkaline Condenser Coil Cleaner, Degreaser and Brightener	Nu-Brite
PRO-BROWN	brown	Ultra High Foaming Alkaline Condenser Coil Cleaner, Degreaser and Brightener	Alka-Brite Plus
PRO-RED+	red	Foaming Acid Coil Cleaner and Brightener (contains no hydrofluoric [HF] acid)	Cal-Brite
PRO-BUBBLE	pink	Freeze-Protected Polymer Based Spray Leak Detector	Cal-Blue & Fluorescent Gas Leak Detectors
SANI C-N-D	blue 	Air Handler and Drain Pan Disinfectant	Bio-Fresh
FLOW-PLUS	blue	Long Lasting Polymer Pan Treatment	Pan Pads

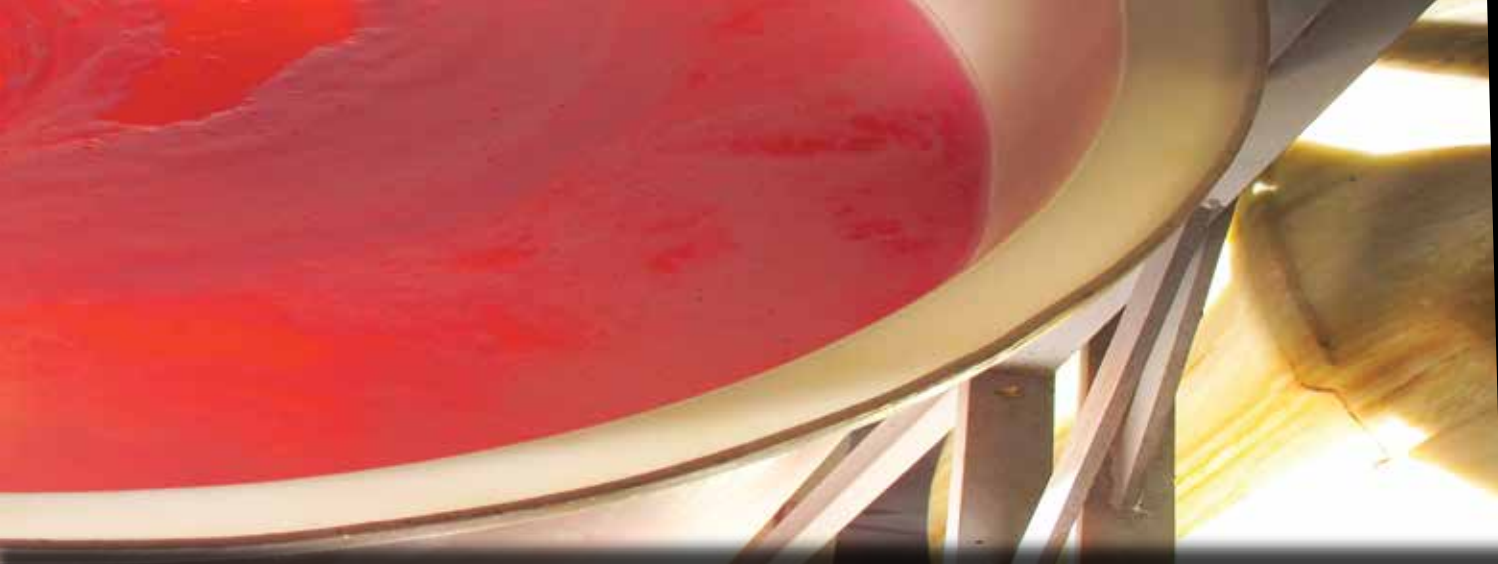

Virginia KMP	Stewart Hall	Rectorseal	Hydro-Balance	Ace	Vapco
THERE IS NO EQUIVALENT TO TRIPLE-D					
Acti-Kleen	Coil-Rite	Concentrated Evaporator	Hydro-Coil	Non-Rinse Evaporator Cleaner	H.P. Cleaner
Alki-Foam	Renewz	Alkaline Extra Strength	Hydro-Kleen	Alkaline Coil Cleaner	Foaminator
Foam-Max	Foam-A-Coil	NO EQUIVALENT	Black Max	Foam-n-Clean	Foamtastic
Acti-Brite	Con-Coil	Condenser Coil Cleaner	Hydro-Foam	Supreme Coil Cleaner	Brite-Alum
Locator Leak Detector	NO EQUIVALENT	Better Bubble	NO EQUIVALENT	Fast Find Leak Detector LT	Low Temp Bubbles
NO EQUIVALENT	Coil & Duct Disinfectant	NO EQUIVALENT	NO EQUIVALENT	Bacti-Gard	NO EQUIVALENT
CDC Anti-Clog	Actabs	NO EQUIVALENT	Slime Away	Pan Protector	Pan Pills



Authorized by USDA for use in Federally inspected meat and poultry plants



EPA Registered

# Condensate Pan Treatments – SIMPLIFIED

## THE NEED

Environmental debris, slime, rust, etc. accumulate in condensate drain pans resulting in:

- Indoor Air Quality problems including musty odors and Dirty Sock Syndrome
- Pan overflows caused by plugged drain lines
- Equipment malfunction

## THE SOLUTION

Use pan treatment products as part of a regular preventive maintenance program to:

- Eliminate one of the causes of Sick Building Syndrome
- Stop costly overflow problems that damage floors, ceilings, and furniture
- Reduce unscheduled service calls

## THE PRODUCTS

### EXTENDED RELEASE TREATMENTS

- Several manufacturers produce various time release products
- Highest value — most active ingredient per dollar
- Easiest maintenance program — dose only once every three months or longer
- Only effective solution for equipment larger than six tons

### RAPID RELEASE TREATMENTS

- Lowest cost per tablet
- Shortest time between dosing



Super



Best



Good



Economy

## Flow-Plus™ Condensate Pan Treatment

- A true water activated, time release treatment
- Water soluble polymer leaves no residue or carrier to be removed
- Adheres to drain pans — eliminates product floating and blocking the drain line
- No corrosive vapors — safe for computer rooms
- Recommended dosage — choose size according to equipment tonnage. Each size is designed to last a minimum of three months.

FLOW-PLUS-25	— 1/2 to 3 tons
FLOW-PLUS-200	— 1/2 to 3 tons
FLOW-PLUS-6	— 3 to 5 tons
FLOW-PLUS-10	— 5 to 20 tons
FLOW-PLUS-125	— 20 to 50 tons

*STACKABLE!*  
This unique feature increases the time between maintenance visits.



## Pro-Treat® 151 Premium Condensate Drain Pan Treatment

- EPA Registered
- Kills algae and eliminates odors
- Fast acting
- Residual effect of the clean pan lasts for a month
- No corrosive vapors — safe for computer rooms
- Recommended dosage: 1 tablet for every 3 tons each month

## Pro-Treat® 161 Condensate Drain Pan Treatment

- More active ingredient than the economy version
- Fast acting
- Residual effect of the clean pan lasts for about a month
- No corrosive vapors — safe for computer rooms
- Recommended dosage: 2 tablets for every 3 tons each month

## Pro-Treat® 200 Condensate Drain Pan Treatment

- Lowest cost product per tablet
- Sufficient active ingredient to treat the pan
- No corrosive vapors — safe for computer rooms
- Recommended dosage: 3 tablets for every 3 tons each month

# 3-STEP PROCESS for Solving IAQ Problems

1



## STEP 2: DISINFECT

### SANI C-N-D™ Coil and Drain Pan Disinfectant

Disinfect and deodorize the evaporator coil and drain pan with SANI C-N-D™, an EPA registered biocide, fungicide, viricide, and mildewstat. The broad spectrum biocide in SANI C-N-D™ assures control of many airborne pathogens that can be spread via contaminated air handling equipment.

2



## STEP 1: CLEAN

### TRIPLE-D™ Degreaser • Detergent • Deodorant

Clean the evaporator coil and condensate pan with TRIPLE-D™, a USDA authorized non-foaming alkaline coil cleaner. Cleaning the dirt from the coil and pan not only improves equipment efficiency, but also removes an important source of contamination that can create slime and sludge in the drain pan and cause pan overflow.

*The American Lung Association states that most people spend 90% of their time indoors<sup>1</sup>. DiversiTech offers the 3-STEP PROCESS to help control IAQ problems caused by the micro-organisms in the atmosphere in which we live and work.*

<sup>1</sup>www.lungusa.org

## STEP 3: MAINTAIN

### FLOW-PLUS™ Condensate Pan Treatment

Place FLOW-PLUS™ in the condensate pan (choose size according to equipment tonnage below). FLOW-PLUS™ is a totally soluble long term polymer treatment that keeps the drain pan and condensate lines clean for a minimum of three months. This prevents pan overflow problems.

PRODUCT NO.	EQUIPMENT TONNAGE
FLOW-PLUS-25	1/2 to 3 tons
FLOW-PLUS-200	1/2 to 3 tons
FLOW-PLUS-6	3 to 5 tons
FLOW-PLUS-10	5 to 20 tons
FLOW-PLUS-125	20 to 50 tons

3



### Why clean coils?

#### CONDENSER COIL

Cleaning the condenser coil does one thing — improves the heat transfer efficiency between the refrigerant inside the coil and the ambient air outside. The more efficient this heat transfer, the more efficiently the cooling system operates.

With efficient heat transfer and an efficiently operating condensing unit, the system consumes less energy because it draws less current. By lowering current consumed in the unit, the life of the equipment is extended.

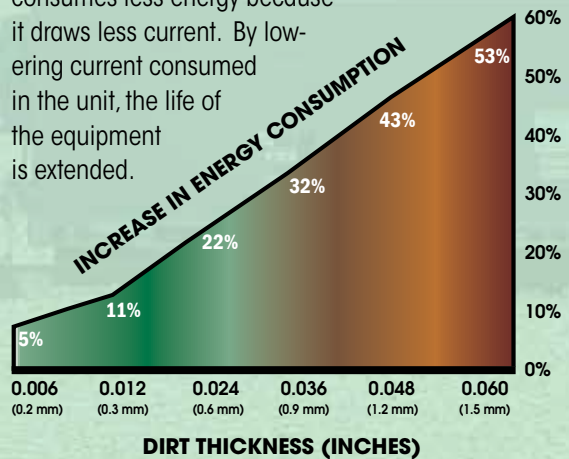

#### EVAPORATOR COIL

Cleaning the evaporator coil improves indoor air quality. It addresses building related illness and sick building syndrome.

### How frequently should coils be cleaned?

We recommend a minimum of twice per year, more frequently if there is dirty ambient air.

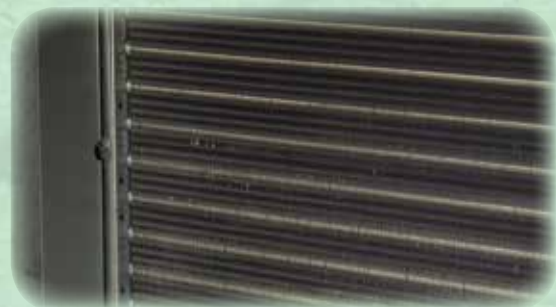

**COIL CLEANERS**

**Triple-D™ Universal Coil Cleaner**

Triple-D™ is a Universal Coil Cleaner suitable for use on condenser *and* evaporator coils. Metal safe and does not attack aluminum or copper coil components, extending equipment life and diminishing potential for refrigerant leaks. Safe for rooftop units.

Triple-D™ is available in a package to fit any contractors needs — super concentrated liquid, pre-mixed trigger sprayer, convenient aerosol, and industry leading Granular Coil Cleaner. In liquid form, Triple-D™ is super concentrated. A single gallon of concentrate makes 75% more mixed coil cleaner than conventional concentrations. The liquid concentrate is also NSF Registered, assuring that it is safe as a cleaner in restaurants, hospitals, government institutions, and any food preparation area (rinse thoroughly after use).

Triple-D™ is a safer, more versatile product than conventional acid or non-acid coil cleaners. One product does it all — truly a Universal Coil Cleaner.

TRIPLE-D



CATALOG NO.	DESCRIPTION	UOM	ORDER MULTIPLE
<b>TRIPLE-D</b>	Triple-D™ – 1 gallon concentrate	EA	4
<b>TRIPLE-D-5</b>	Triple-D™ – 5 gallon concentrate	EA	1
<b>TRIPLE-D-AER</b>	Triple-D™ – 19 oz. Aerosol	EA	12
<b>TRIPLE-D-GRAN</b>	Triple-D™ – 1 lb. Granular	EA	12
<b>TRIPLE-D-32</b>	Triple-D™ – 32 oz. bottle – concentrate	EA	12
<b>TRIPLE-D-RTU</b>	Triple-D™ – 1 quart trigger sprayer – pre-diluted	EA	12
<b>TRIPLE-D-55</b>	Triple-D™ – 55 gallon drum	EA	1
<b>TRIPLE-D-FC</b>	Triple-D™ – 1 gallon concentrate FOR CANADA	EA	4
<b>TRIPLE-D-RTV-FC</b>	Triple-D™ – 1 quart spray FOR CANADA	EA	12

**Eco-Coil™ Environmentally Friendly Coil Cleaner**

Eco-Coil™ is an effective, environmentally friendly coil cleaner and brightener. Eco-Coil™ uses biodegradable, earth-friendly components to quickly clean away dirt and deposits. This formula is effective on both indoor and outdoor coils and cleans while protecting the environment from harsh chemicals.

ECO-COIL



CATALOG NO.	DESCRIPTION	UOM	ORDER MULTIPLE
<b>ECO-COIL-32</b>	Eco-Coil™ Environmentally Friendly Coil Cleaner – 32 oz. bottle	EA	12
<b>ECO-COIL</b>	Eco-Coil™ Environmentally Friendly Coil Cleaner – 1 gallon container	EA	4
<b>ECO-COIL-5</b>	Eco-Coil™ Environmentally Friendly Coil Cleaner – 5 gallon pail	EA	1
<b>ECO-COIL-55</b>	Eco-Coil™ Environmentally Friendly Coil Cleaner – 55 gallon drum	EA	1

**Pro-Brown™**

An ultra-high foaming formula that pulls out deeply embedded dirt. The fast, dual-action formula cleans and brightens. Pro-Brown™ is biodegradable and safer than foaming hydrofluoric acid cleaners.

PRO-BROWN



CATALOG NO.	DESCRIPTION	UOM	ORDER MULTIPLE
<b>PRO-BROWN-32</b>	Pro-Brown™ Foaming Coil Cleaner – 32 oz. bottle	EA	12
<b>PRO-BROWN</b>	Pro-Brown™ Foaming Coil Cleaner – 1 gallon container	EA	4
<b>PRO-BROWN-5</b>	Pro-Brown™ Foaming Coil Cleaner – 5 gallon pail	EA	1
<b>PRO-BROWN-55</b>	Pro-Brown™ Foaming Coil Cleaner – 55 gallon drum	EA	1

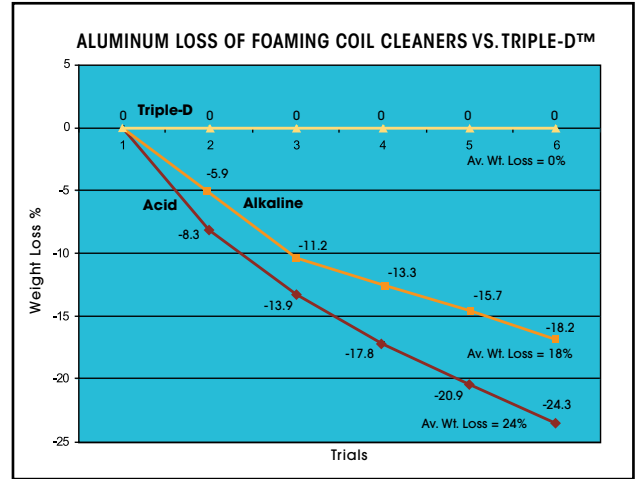

Conventional foaming acid and non-acid coil cleaners attack and chemically react with the aluminum coil components. This reaction is exhibited by a foaming action. The attack/reaction dissolves the aluminum, destroying the heat-transfer ability of the coil and creating the potential for refrigerant leaks.

**Pro-Blue™**

Pro-Blue™ is a heavy-foaming, alkaline-based coil cleaner which will assist in removing the build-up on your air-cooled condenser. Buy Pro-Blue™ and help your condenser look as good as new.

PRO-BLUE



CATALOG NO.	DESCRIPTION	UOM	ORDER MULTIPLE
<b>PRO-BLUE-32</b>	Pro-Blue™ Foaming Concentrate (non-acid) – 32 oz. bottle	EA	12
<b>PRO-BLUE</b>	Pro-Blue™ Foaming Concentrate (non-acid) – 1 gallon container	EA	4
<b>PRO-BLUE-5</b>	Pro-Blue™ Foaming Concentrate (non-acid) – 5 gallon pail	EA	1
<b>PRO-BLUE-55</b>	Pro-Blue™ Foaming Concentrate (non-acid) – 55 gallon drum	EA	1

**Pro-Green™**

Pro-Green™ is a non-toxic, self rinsing evaporative coil cleaner which is a safe-to-use product on your evaporator coils. This coil cleaner can also be used on air-cooled condensers, electronic filters and fan blades.

PRO-GREEN



CATALOG NO.	DESCRIPTION	UOM	ORDER MULTIPLE
<b>PRO-GREEN-32</b>	Pro-Green™ No Rinse (non-toxic) – 32 oz. bottle	EA	12
<b>PRO-GREEN</b>	Pro-Green™ No Rinse (non-toxic) – 1 gallon container	EA	4
<b>PRO-GREEN-5</b>	Pro-Green™ No Rinse (non-toxic) – 5 gallon pail	EA	1
<b>PRO-GREEN-55</b>	Pro-Green™ No Rinse (non-toxic) – 55 gallon drum	EA	1



**COIL CLEANERS cont'd**

**Pro-Red Plus™**

Pro Red Plus™ Non Acid Coil Cleaner and Brightener is an easy to use, concentrated, fast acting product that foams and lifts away stubborn deposits from air cooled condensers and coils. It removes tarnish and corrosion deposits, and leaves a bright clean shine on aluminum and copper coils.

Pro Red Plus™ Non Acid Coil Cleaner and Brightener cleans by chemical action. Its brightening properties are as effective as conventional acid coil cleaners, but Pro Red Plus™ does not contain extremely toxic hydrofluoric acid. The vigorous foaming action eliminates the need for prolonged soaking, steam cleaning or scrubbing coils. Non acid formula does not emit corrosive fumes, and will not rust ferrous metals



CATALOG NO.	DESCRIPTION	UOM	ORDER MULTIPLE
<b>PRO-RED+32</b>	Pro-Red Plus™ Cleaner and Brightener (non-acid) – 32 oz. bottle	EA	12
<b>PRO-RED+</b>	Pro-Red Plus™ Cleaner and Brightener (non-acid) – 1 gallon container	EA	4
<b>PRO-RED+5</b>	Pro-Red Plus™ Cleaner and Brightener (non-acid) – 5 gallon pail	EA	1
<b>PRO-RED+55</b>	Pro-Red Plus™ Cleaner and Brightener (non-acid) – 55 gallon drum	EA	1

**Fresh-Coil**

Specifically designed for use with mini split wall and ceiling cassettes. Fresh-Coil features a 3' (1 meter) hose with a brass spray nozzle for easy reach into and behind indoor cassette coils.



CATALOG NO.	DESCRIPTION	UOM	ORDER MULTIPLE
<b>FRESH-COIL</b>	Fresh Coil cleaner for mini split cassettes, 15oz	EA	12

**Pro-Yellow™**

Pro-Yellow™ is an easy to apply, non-acid coil cleaner and brightener. This effective formula quickly removes dirt and grime from outdoor coils and leaves them clean and bright. It's strong foaming action removes even stubborn deposits easily.



CATALOG NO.	DESCRIPTION	UOM	ORDER MULTIPLE
<b>PRO-YELLOW-32</b>	Pro-Yellow™ (non-toxic) – 32 oz. bottle	EA	12
<b>PRO-YELLOW</b>	Pro-Yellow™ (non-toxic) – 1 gallon container	EA	4
<b>PRO-YELLOW-5</b>	Pro-Yellow™ (non-toxic) – 5 gallon pail	EA	1
<b>PRO-YELLOW-55</b>	Pro-Yellow™ (non-toxic) – 55 gallon drum	EA	1

**Pro-Kleen™**

A unique foaming acid coil cleaner designed to replace hazardous hydrofluoric acid coil cleaners. It contains a synergistic combination of mineral acids, corrosion inhibitors, biodegradable surfactants, penetrants, and degreasers that emulsify, solubilize and neutralize soils leaving a clean, bright, efficient coil surface. The easy-rinse formula removes a broad range of soils and does not contain dangerous hydrofluoric or bipotassium phosphate.



CATALOG NO.	DESCRIPTION	UOM	ORDER MULTIPLE
<b>PRO-KLEEN</b>	Pro-Kleen™ Outdoor Coil Cleaner – 1 gallon container	EA	4
<b>PRO-KLEEN-5</b>	Pro-Kleen™ Outdoor Coil Cleaner – 5 gallon pail	EA	1
<b>PRO-KLEEN-55</b>	Pro-Kleen™ Outdoor Coil Cleaner – 55 gallon drum	EA	1

**ACCESSORIES**

**Coil Guard™**

Ideally used in coastal areas, where salt air accelerates rust and decay. Highly recommended for use in all geographical areas to prolong the life of a unit. When applied properly, Coil Guard™ dries quickly and immediately resists salt spray, alcohol, acids, and soap solutions. Weather will not blacken it. Coil Guard™ has high dielectric properties and has no effect on heat transfer. Our blue tinted product is used to ensure complete coverage of coating.



CATALOG NO.	DESCRIPTION	UOM	ORDER MULTIPLE
<b>CG-AER</b>	Clear Coil Guard™ – 20 oz. Aerosol	EA	12
<b>CGB-AER</b>	Blue Coil Guard™ – 20 oz. Aerosol	EA	12

**Cool-Weld™ Heat Barrier Spray**

Spray on thick gel formula that protects surfaces from heat and damage. Odorless, non-toxic gel coats rubber, plastic, and painted surfaces to shield them during welding or soldering.



CATALOG NO.	DESCRIPTION	UOM	ORDER MULTIPLE
<b>COOLWELD-32</b>	Cool-Weld™ Heat Barrier Spray – 32 oz. Container	EA	12

**ACCESSORIES cont'd**

**Pan-Patch™**

Pan-Patch™ is a two part epoxy coating with anti-microbial additives designed for HVAC applications. It is a self leveling formula that is ideal in a damp or wet environment. Pan-Patch™ resists corrosion and stops pan leaks without replacing the pan. Light gray in color, one gallon covers about 160 square feet with 10 mil thickness.

PANPATCH



CATALOG NO.	DESCRIPTION	COVERAGE	UOM	ORDER MULTIPLE
<b>PANPATCH-BAG</b>	Pan-Patch™ Pan Sealant – Bag, pack of 10	8 sq. ft.	EA	10
<b>PANPATCH-32</b>	Pan-Patch™ Pan Sealant – 1 Quart	40 sq. ft.	EA	9
<b>PANPATCH</b>	Pan-Patch™ Pan Sealant – 1 Gallon	160 sq. ft.	EA	4

**COIL CLEANING AEROSOLS**

**Saf-N-Kleen™ Aerosol Solvent Coil Cleaner**

High-solvency formula quickly and easily dissolves dirt, grease, oil or other residue while the blasting nozzle separates the materials from the surface. Non-flammable, non-conductive formula is safe to use on live equipment.



CATALOG NO.	DESCRIPTION	UOM	ORDER MULTIPLE
<b>357-20</b>	Saf-N-Kleen™ Solvent Coil Cleaner – 18 oz. Aerosol	EA	12

**Foam-Plus™ Aerosol Foaming Coil Cleaner**

Heavy-duty foaming detergent coil cleaner in an aerosol can. Non-flammable and water-based with no chlorinated solvents. Blasting foam stream reaches into tight areas for maximum cleaning. The foaming alkaline detergent quickly liquifies dirt, grease, oil or other residue and is completely self-rinsing on condensate producing coils.



CATALOG NO.	DESCRIPTION	UOM	ORDER MULTIPLE
<b>358-20</b>	Foam-Plus™ Foaming Coil Cleaner – 19 oz.	EA	12
<b>358-20S</b>	Foam-Plus™ - Spanish Label - 19 oz.	EA	12

**DRAIN PAN DISINFECTANT, SEALANT**

**Sani C-N-D™ Coil and Drain Pan Disinfectant**

Sani C-N-D™ is an EPA registered disinfectant, fungicide, mildewstat and viricide. It is ready-to-use and assures consistent, effective results. Sani C-N-D™ destroys "dirty sock," mildew and other malodors.



CATALOG NO.	DESCRIPTION	UOM	ORDER MULTIPLE
<b>SANI-CND-32</b>	Sani C-N-D™ Disinfectant – 32 oz. Container	EA	12
<b>SANI-CND</b>	Sani C-N-D™ Disinfectant – 1 Gal. Container	EA	4
<b>SANI-CND-5</b>	Sani C-N-D™ Disinfectant – 5 Gallon Pail	EA	1
<b>SANI-CND-55</b>	Sani C-N-D™ Disinfectant – 55 Gallon Drum	EA	1

**Pan-Kote Heavy Duty Drain Pan Patch**

A super-durable rubberized coating used to fill-in and patch HVAC drain pans. Seals out rust and corrosion. Stays flexible in variable weather conditions.



CATALOG NO.	DESCRIPTION	UOM	ORDER MULTIPLE
<b>641-14</b>	Pan-Kote Drain Pan Patch – 14 oz. Aerosol	EA	12

## FLUSHING PRODUCTS

### Pro-Flush™ HVAC Flushing Solvent

A flushing solvent for A/C and refrigeration systems formulated for R 410A retrofits, refrigerant conversions and compressor burnouts. Compatible with all refrigerants and compressor oils. All solvents in Pro-Flush™ are non VOC and conform to EPA SNAP standards: low toxicity and residue free. Available as a kit or in a 16 oz. solvent refill. The kit makes servicing quick, easy, and safe, as well as assuring you get to the job site with all necessary hardware in hand for 1 stop servicing. The kit includes: 16 oz. container of Pro-Flush™ solvent, refillable Pro-Flush™ injector tool pressure tank, pressure relief valve for added safety, large rubber adapter that flushes up to 1-1/4" line sets, service hose.



CATALOG NO.	DESCRIPTION	UOM	ORDER MULTIPLE
<b>PF-KIT</b>	Pro-Flush™ Kit – injector, 16 oz. refill, nozzle adapter and hose	EA	3
<b>PF-08</b>	Pro-Flush™ HVAC Flushing Solvent – 8 oz. Refill	EA	6
<b>PF-16</b>	Pro-Flush™ HVAC Flushing Solvent – 16 oz. Refill	EA	6
<b>PF-ADAPTER</b>	Pro-Flush™ Line Set Adapter	EA	1
<b>PF-IGUN</b>	Replacement Injector Tool	EA	1
<b>PF-IHOSE</b>	2' Replacement Hose	EA	1

## GLYCOLS

DiversiTech produces the most complete line of industrial coolant and heat transfer products in the HVAC/R Industry. Our product line includes ProTek PG propylene glycol products formulated with food-grade corrosion inhibitors and ProTek EG ethylene glycol products for industrial applications. Both product groups are designed to provide freeze and burst protection and are formulated with inhibitors and antifoam agents to provide long-term stability against system corrosion and fouling.

### ProTek EG™

An inhibited ethylene glycol based heat transfer fluid designed for use in hydronic, chilled and closed water.



CATALOG NO.	DESCRIPTION	GLYCOL/ WATER RATIO	UOM	ORDER MULTIPLE
<b>EG</b>	ProTek EG™ – 1 Gallon Jug	95/5	EA	4
<b>EG-5</b>	ProTek EG™ – 5 Gallon Pail	95/5	EA	1
<b>EG-55</b>	ProTek EG™ – 55 Gallon Drum	95/5	EA	1

### ProTek™ Closed Loop Heat Transfer Fluid

ProTek™ for closed loop water recirculation systems is a blue liquid. Available in three concentrations: original ProTek-100™, ProTek-50™, and ProTek-Plus™. Each concentration may be further diluted to alter freeze and burst temperatures. Refer to the technical data sheet for specific information.



CATALOG NO.	DESCRIPTION	GLYCOL/ WATER RATIO	UOM	ORDER MULTIPLE
<b>PG-50</b>	ProTek-50™ – 1 Gallon Jug	35/65	EA	4
<b>PG-50-5</b>	ProTek-50™ – 5 Gallon Pail	35/65	EA	1
<b>PG-50-55</b>	ProTek-50™ – 55 Gallon Drum	35/65	EA	1

### ProTek™ PG 100

ProTek 100™ is an inhibited propylene glycol based industrial heat transfer fluid and antifreeze that contains food grade corrosion inhibitors. It is suitable for use in potable water systems. ProTek 100™ is designed to provide freeze and burst protection, excellent thermal conductance, protection against corrosion and fouling and long term stability in closed recirculating water loops. ProTek 100™ provides burst protection to 100°F. Freeze points and burst points are controlled by the propylene glycol to water ratio.



CATALOG NO.	DESCRIPTION	GLYCOL/ WATER RATIO	UOM	ORDER MULTIPLE
<b>PG-100</b>	ProTek-100™ – 1 Gallon Jug	70/30	EA	4
<b>PG-100-5</b>	ProTek-100™ – 5 Gallon Pail	70/30	EA	1
<b>PG-100-55</b>	ProTek-100™ – 55 Gallon Drum	70/30	EA	1

### ProTek™ PG Plus

ProTek PLUS™ is an inhibited propylene glycol based industrial heat transfer fluid and anti freeze that contains food grade corrosion inhibitors. It is suitable for use in potable water systems. ProTek PLUS™ is designed to provide freeze and burst protection, excellent thermal conductance, protection against corrosion and fouling and long term stability in closed recirculating water loops. ProTek PLUS™ must be mixed with water to provide freeze and burst protection. Freeze points and burst points are controlled by the propylene glycol to water ratio.



CATALOG NO.	DESCRIPTION	GLYCOL/ WATER RATIO	UOM	ORDER MULTIPLE
<b>PG-PLUS</b>	ProTek-Plus™ – 1 Gallon Jug	95/5	EA	4
<b>PG-PLUS-5</b>	ProTek-Plus™ – 5 Gallon Pail	95/5	EA	1
<b>PG-PLUS-55</b>	ProTek-Plus™ – 55 Gallon Drum	95/5	EA	1

**GLYCOLS cont'd**

**ProTek™ PG AL – Safe for Aluminum Heat Exchangers**

Universal heat transfer fluid. An inhibited heat transfer fluid that is safe for use in boilers and hydronic systems including aluminum heat exchangers. Operating range is -100°F to 190°F. ProTek™ PG-AL is an orange liquid.

PG-AL



CATALOG NO.	DESCRIPTION	GLYCOL/ WATER RATIO	UOM	ORDER MULTIPLE
<b>PG-AL</b>	ProTek™ PG-AL – 1 Gallon Jug	70/30	EA	4
<b>PG-AL-5</b>	ProTek™ PG-AL – 5 Gallon Pail	70/30	EA	1
<b>PG-AL-55</b>	ProTek™ PG-AL – 55 Gallon Drum	70/30	EA	1

**ProTek BG™ for Cast Iron Water Boilers**

A red liquid boiler grade product formulated specifically with corrosion inhibitors necessary for use in water boilers.

PG-BG



CATALOG NO.	DESCRIPTION	GLYCOL/ WATER RATIO	UOM	ORDER MULTIPLE
<b>PG-BG</b>	ProTek-BG™ – 1 Gallon Jug	70/30	EA	4
<b>PG-BG-5</b>	ProTek-BG™ – 5 Gallon Pail	70/30	EA	1
<b>PG-BG-55</b>	ProTek-BG™ – 55 Gallon Drum	70/30	EA	1

**HEATING PRODUCTS**

**Sure Burn™ Concentrated Fuel Oil Treatment**

A state-of-the-art fuel oil treatment designed to insure oil burner ignition even in the most extreme weather conditions. Sure Burn™ acts as a water dispersant and promotes cleaner, more efficient combustion. Also inhibits sludge formation and combats fuel tank corrosion.

HP-SB-16



CATALOG NO.	DESCRIPTION	UOM	ORDER MULTIPLE
<b>HP-SB-16</b>	Sure Burn™ Concentrated Heating Fuel Treatment – 16 oz.	EA	12

**Spill Kill™ Catalytic Soot Remover**

Ready-to-use, non-flammable, non-corrosive catalytic soot remover cleans the combustion chamber. Catalytic cleaning action reduces time-consuming vacuuming of the burner chamber. Residual action slows soot accumulation.

HP-SK-16



CATALOG NO.	DESCRIPTION	UOM	ORDER MULTIPLE
<b>HP-SK-16</b>	Soot Kill™ Catalytic Soot Remover Spray – 16 oz.	EA	12

**Spill Kill™ Liquid – Fuel Spill Deodorant Spray**

Neutralizes noxious fuel oil odors while imparting a pleasant residual fragrance. Using the trigger spray applicator, spray directly on the spill and mist into the air as a space deodorant. The safe, non-flammable formula lends itself to other deodorizing applications where noxious odors are a problem.

HP-SKDS-16



CATALOG NO.	DESCRIPTION	UOM	ORDER MULTIPLE
<b>HP-SKDS-16</b>	Spill Kill™ Fuel Spill Deodorant Spray – 16 oz.	EA	12

**Spill Kill™ Powder – Fuel Spill Deodorant and Absorbent**

A one-step liquid absorbent and deodorant with a convenient shaker top. Multi-functional Spill Kill™ absorbs and deodorizes fuel oil and other liquid spills. The unique granular formula soaks up liquids and entraps odors much faster than dusty powders. The quick-absorbing action minimizes the slip hazards associated with liquid spills.

HP-SKDP-20



CATALOG NO.	DESCRIPTION	UOM	ORDER MULTIPLE
<b>HP-SKDP-20</b>	Spill Kill™ Granular Fuel Oil Deodorant and Absorbent – 20 oz.	EA	12

## HOSES, SPRAYERS

### Power Sprayer

DiversiTech's Power Sprayer makes coil cleaning easier and faster! Designed as a backpack sprayer, it holds up to 4 gallons of coil cleaning solution. The battery powered unit will spray continuously for 10 hours on a single charge. Included are three different nozzles to give you the right spray for any situation. It also features: padded backpack straps for a comfortable fit, plug-in charger for fast recharging, a convenient center mount handle, an extra long spray wand with curved tip for accurate application, and a large on/off valve which can lock in position for easier spraying of big jobs. The large tank opening also makes it easy to add coil cleaner and mix to the correct ratio. The Power Sprayer is compatible with all DiversiTech coil cleaners.



CATALOG NO.	DESCRIPTION	UOM	ORDER MULTIPLE
PS-1	Battery powered/rechargeable backpack sprayer for coil cleaning	EA	1

### Dial-a-Mix Sprayer

Save time and money by dialing in the exact mix ratio to properly clean the coil. This sprayer features 5 mix ratios, a 1/2 gallon capacity bottle and a quick disconnect for fast and easy rinsing.



CATALOG NO.	DESCRIPTION	UOM	ORDER MULTIPLE
540-GUN	Dial-a-Mix Sprayer	EA	6

### Garden Hose

High quality product priced for high volume sales. Soft-Flex formulation makes the 5 ply Hose easy to handle. Withstands 500 psi water pressure. Heavy duty solid brass couplings and collar. Full Lifetime Guarantee!

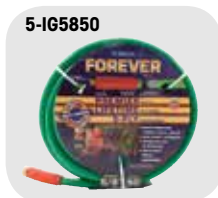

CATALOG NO.	DESCRIPTION	UOM	ORDER MULTIPLE
5-IG5850	Green Flexon 5-Ply Forever Garden Hose	EA	5

### All Purpose Sprayers

Lightweight, versatile gallon size bottle has a 28" flexible hose and easy-to-carry handle. Best for big jobs in hard-to-reach places. Adjustable nozzle will atomize any low viscosity liquid. Adjusts from a mist to a 12' jet stream or anything in between. One pint container has a measured ounce guide. Ideal for water treatment chemicals.



CATALOG NO.	DESCRIPTION	UOM	ORDER MULTIPLE
BS-64	Gallon Size Sprayer	EA	6
BS-16	Pint Size Sprayer	EA	12
BS-32	Quart Size Sprayer	EA	12

### Compression Sprayers

Acid impervious poly design with a 36" (91cm) reinforced hose, shut-off with lock-on feature for continuous spraying, a 2-piece nozzle that's detachable for easy clean up and fits directly to the shut-off or extension wand. The Hand-Held Sprayer has a 48 oz. (1.4 l) capacity, perfect for small areas. All sprayers have a full 5 year warranty.



CATALOG NO.	DESCRIPTION	UOM	ORDER MULTIPLE
1002	Hand Held Sprayer	EA	1
2601	1 Gallon Wand Sprayer	EA	1
2602	2 Gallon Wand Sprayer	EA	1
2603	3 Gallon Wand Sprayer	EA	1

### Hot Water Hose

High burst strength. 500 PSI. Withstands hot water up to 160°F. EPDM tube. Heavy duty solid brass couplings.



CATALOG NO.	DESCRIPTION	UOM	ORDER MULTIPLE
5-HW5850	5/8" x 50' Hot Water Hose	EA	5

### Pistol Grips & Water Nozzle

Pistol Grip – 540-572 Insulated:  
For spraying hot or cold water. Heavy-duty, self adjusting "duck" packing for lifetime proof seal.  
Water Nozzle – 540-573 Un-insulated:  
Heavy-duty and holds open clip for continuous spraying. Self-adjusting "duck" for leak proof seal.



CATALOG NO.	DESCRIPTION	UOM	ORDER MULTIPLE
540-572	Insulated Pistol Grip	EA	12
540-573	Uninsulated Water Nozzle	EA	12

**ICE MACHINE PRODUCTS**

**Super-Kool™ Nickel-Safe and Metal-Safe Ice Machine Cleaner**

An economical, fast-acting, non-foaming acid sequestant formula that quickly removes soil and mineral buildup. This safe, highly-concentrated, inhibited formula will not attack nickel or other metal components. USDA AUTHORIZED



CATALOG NO.	DESCRIPTION	UOM	ORDER MULTIPLE
<b>SUPER-KOOL-16</b>	Super-Kool™ Ice Machine Cleaner – 16 oz. Bottle	EA	12
<b>SUPER-KOOL</b>	Super-Kool™ Ice Machine Cleaner – 1 Gallon Container	EA	4

**LEAK DETECTORS**

**Bubble-N-Trouble™ Freeze Protected Spray-On Leak Detector**

Non-corrosive, non-toxic, and biodegradable. Does not attack metal or interfere with brazing or soldering. Spray-on application allows easy access for hard to reach places. Tacking agent holds solution on test surface making Bubble-N-Trouble™ very economical. USDA AUTHORIZED



CATALOG NO.	DESCRIPTION	UOM	ORDER MULTIPLE
<b>BNT-32</b>	Bubble-N-Trouble™ Freeze Protected Leak Detector – 32 oz. Spray	EA	12
<b>BNT-1</b>	Bubble-N-Trouble™ Freeze Protected Leak Detector – 1 Gallon Container	EA	4

**Pro-Bubble™ Leak Detector**

Easy-to-use, high-bubbling, viscoelastic blue leak detector. New improved formula.



CATALOG NO.	DESCRIPTION	UOM	ORDER MULTIPLE
<b>PRO-BUBBLE-32</b>	Pro-Bubble™ Leak Detector – 32 oz. Bottle with Spray Top	EA	12

**Radiant Leak Finder™**

Radiant color and viscous clinging formula exposes the smallest leaks. Freeze-protected – remains effective down to 0° F.



CATALOG NO.	DESCRIPTION	UOM	ORDER MULTIPLE
<b>RLF-8</b>	Radiant Leak Finder™ – 8 oz. Container	EA	12

**ODOR NEUTRALIZERS**

**Duct-Fresh Gel**

A non-toxic, super-effective odor neutralizer for HVAC ducts, proficient at destroying stubborn odors including pet, smoke, and musty smells in residential, industrial and commercial applications. Effective for up to 6 months.



CATALOG NO.	DESCRIPTION	UOM	ORDER MULTIPLE
<b>DUCT-FRESH-8</b>	Duct-Fresh Gel – 8 oz.	EA	12
<b>DUCT-FRESH-16</b>	Duct-Fresh Gel – 16 oz.	EA	8
<b>DUCT-FRESH-48</b>	Duct-Fresh Gel – 48 oz.	EA	8

**Duct-Fresh Spray**

A non-toxic, instantaneous, super-effective odor neutralizer for HVAC ducts. Destroys stubborn pet odors, smoke, and musty smells in residential, industrial and commercial applications. Great for spot-treating malodor problem areas.



CATALOG NO.	DESCRIPTION	UOM	ORDER MULTIPLE
<b>DUCT-FRESH-32</b>	Duct-Fresh Spray – 1 Quart	EA	12

**PAN TREATMENTS**

**Flow-Plus™ Condensate Pan Treatment**

A unique polymer formula that maintains condensate flow and prevents drain pan overflow. 100% active. No residue—no waste—nonclogging. Effective, long-term condensate activated release. Environmentally safe, non-toxic, and non-corrosive. Also economical with sizes to meet all tonnage requirements.



CATALOG NO.	EQUIPMENT TONNAGE
<b>FLOW-PLUS-25</b>	1/2 to 3 tons
<b>FLOW-PLUS-200</b>	1/2 to 3 tons
<b>FLOW-PLUS-6</b>	3 to 5 tons
<b>FLOW-PLUS-10</b>	5 to 20 tons
<b>FLOW-PLUS-125</b>	20 to 50 tons

CATALOG NO.	DESCRIPTION	UOM	ORDER MULTIPLE
<b>FLOW-PLUS-25</b>	Flow-Plus™ Condensate Pan Treatment – 25 Tabs/Jar	EA	12
<b>FLOW-PLUS-200</b>	Flow-Plus™ Condensate Pan Treatment – 200 Tabs/Jar	EA	4
<b>FLOW-PLUS-6</b>	Flow-Plus™ Condensate Pan Treatment – 6 - 1 oz. Blocks	EA	12
<b>FLOW-PLUS-10</b>	Flow-Plus™ Condensate Pan Treatment – 10 oz. Tubs	EA	18
<b>FLOW-PLUS-125</b>	Flow-Plus™ Condensate Pan Treatment – 1.25 lb. Tubs	EA	8

**Pro-Treat® 350 Condensate Drain Pan Treatment**

Place a Pro-Treat® 350 tablet in a condensate drain pan and condensed moisture will slowly dissolve the tablet, thinly coating the pan surface to give prolonged cleaning action on sludge. Dosage: one or two tablets are recommended in each pan per month. For industrial use only!



CATALOG NO.	DESCRIPTION	UOM	ORDER MULTIPLE
<b>PROTREAT-350</b>	Pro-Treat® 350 Condensate Pan Treatment – 100 Tablets per Jar	EA	24

**Pro-Treat® Pan Strips**

Pro-Treat® Pan Strips kill odor causing bacteria and last up to 6 months. Use in the primary drain pan of cooling units such as air conditioners and refrigerators. Pro-Treat® Pan Strips control foul-smelling odors caused by mildew, fungi, bacteria, algae, and slime. For use in hotels, schools, colleges, hospitals, nursing homes, airports, and many other locations.



CATALOG NO.	DESCRIPTION	STRIPS/PACK	UOM	ORDER MULTIPLE
<b>PS-075</b>	Pro-Treat® Pan Strips – for up to 3/4 Ton	10	EA	12
<b>PS-01</b>	Pro-Treat® Pan Strips – for 1 to 2 Ton	10	EA	12
<b>PS-03</b>	Pro-Treat® Pan Strips – for 3 to 5 Ton	6	EA	24
<b>PS-07</b>	Pro-Treat® Pan Strips – for 7 to 12 Ton	2	EA	24
<b>PS-20</b>	Pro-Treat® Pan Strips – for 20 to 25 Ton	1	EA	24
<b>PS-40</b>	Pro-Treat® Pan Strips – for 40 to 50 Ton	1	EA	12

EPA Registration #6836-254-69966

**PAN TREATMENTS/DISINFECTANTS**

**Pro-Treat® 151 Premium Condensate Drain Pan Treatment**

Pro-Treat® 151 premium tablets penetrate and help remove sludge that can plug drain pans and drain lines and foul humidifier pans. Kills odors associated with slime and sludge, minimizing maintenance problems from overflow and water damage caused by fouled pans, plugged traps, or drain lines. Tablets are 100% soluble, easy-to-use, and do not form any deposits in the pan or drain line. Approved for computer rooms. Dosage: 1 tablet per 3 tons each month. PROTREAT-151 is EPA registered.



CATALOG NO.	DESCRIPTION	UOM	ORDER MULTIPLE
<b>PROTREAT-151</b>	Pro-Treat® 151 Premium Drain Pan Treatment – 100 Tablets/Jar	EA	12

**Pro-Treat® 152 King-Size Premium Condensate Drain Pan Treatment**

Economical, safe, effective king-size tablets last three times longer. Safe, non-corrosive, odor-free and 100% soluble. Computer room approved. Keeps drain pans and condensate lines clean and free flowing. Dosage: 1 tablet per 3 tons per 3 months.



CATALOG NO.	DESCRIPTION	UOM	ORDER MULTIPLE
<b>PROTREAT-152</b>	Pro-Treat® 152 King-Size Premium Drain Pan Treatment – 12 Tablets/Jar	EA	6

**PAN TREATMENTS/DISINFECTANTS cont'd**

**Pro-Treat® 161 Condensate Drain Pan Treatment**

Controls odors and eliminates condensate drain pan overflows and the resulting water damage. 100% soluble, easy-to-use, non-corrosive, and non-toxic. Use regularly to assure season-long, trouble-free condensate drain pan performance. Approved for computer rooms. Dosage: 2 tablets per 3 tons each month.



CATALOG NO.	DESCRIPTION	UOM	ORDER MULTIPLE
<b>PROTREAT-161</b>	Pro-Treat® 161 Drain Pan Treatment – 100 Tablets/Jar	EA	12

**Pro-Treat® 200 Economy Condensate Drain Pan Treatment**

Economical with 200 tablets per jar. Safe, non-corrosive, odor-free and 100% soluble. Approved for computer rooms. Convenient, easy-to-use tablet form provides prolonged cleaning action. Dosage: 3 tablets per 3 tons per month.



CATALOG NO.	DESCRIPTION	UOM	ORDER MULTIPLE
<b>PROTREAT-200</b>	Pro-Treat® 200 Economy Drain Pan Treatment – 200 Tablets/Jar	EA	12

**Pro-Treat® 217 Economy Condensate Drain Pan Treatment**

Economical with 200 tablets per jar. Safe, non corrosive, odor free and 100% soluble. Approved for computer rooms. Convenient, easy to use tablet form provides prolonged cleaning action. Dosage 3 tablets per 3 tons per month.



CATALOG NO.	DESCRIPTION	UOM	ORDER MULTIPLE
<b>PROTREAT-217</b>	Pro-Treat® 217 Economy Drain Pan Treatment – 200 Tablets/Jar	EA	12

**REFRIGERATION OILS**

**Pro-Lube™ Mineral Oil**

Specialty Chemical mineral oil (by Calumet) is a superior mineral naphthenic refrigeration oil designed to meet the operating requirements of modern residential and commercial air conditioning and refrigeration compressors. These oils have a low pour point, low wax floc temperature and are chemically and thermally stable in the presence of refrigerants. OEM approved by Copeland, Carlyle, Trane, and other major compressor manufacturers. Always follow compressor manufacturer's oil viscosity recommendations. Mineral oil is specially recommended for lubrication of compressors containing ammonia, R-11, 12, 13, 22, 113, 114, 123, 500 and 502 refrigerants in residential, industrial and commercial service. **DO NOT USE WITH HFC REFRIGERANTS SUCH AS R-134A.**

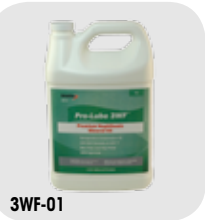

CATALOG NO.	DESCRIPTION	UOM	ORDER MULTIPLE
<b>3WF-01</b>	SUS150 ISO32 Pro-Lube™ Mineral Oil – 1 Gallon Jug	EA	4
<b>3WF-05</b>	SUS150 ISO32 Pro-Lube™ Mineral Oil – 5 Gallon Pail	EA	1
<b>4WF-01</b>	SUS300 ISO68 Pro-Lube™ Mineral Oil – 1 Gallon Jug	EA	4
<b>4WF-05</b>	SUS300 ISO68 Pro-Lube™ Mineral Oil – 5 Gallon Pail	EA	1



**REFRIGERATION OILS cont'd**

**Pro-Lube-ALK™ Alkylbenzene**

Specialty Chemical alkylbenzene is recommended for refrigeration, air conditioning, and heat pump applications using HCFC and CFC refrigerants. An excellent choice when retrofitting to the new refrigerants which are HCFC based such as R-401A (MP-39), R-401B (MP-66), R-402A (HP-80), R-402B (HP-81). OEM approved by Copeland and other compressor manufacturers.



**ALK150-01**

CATALOG NO.	DESCRIPTION	UOM	ORDER MULTIPLE
<b>ALK150-01</b>	SUS150 ISO32 Pro-Lube™ Alkylbenzene – 1 Gallon Jug	EA	4
<b>ALK150-05</b>	SUS150 ISO32 Pro-Lube™ Alkylbenzene – 5 Gallon Drum	EA	1
<b>ALK200-01</b>	SUS200 ISO46 Pro-Lube™ Alkylbenzene – 1 Gallon Jug	EA	4
<b>ALK300-01</b>	SUS300 ISO68 Pro-Lube™ Alkylbenzene – 1 Gallon Jug	EA	4
<b>ALK300-05</b>	SUS300 ISO68 Pro-Lube™ Alkylbenzene – 5 Gallon Drum	EA	1

**Pro-Lube-POE™ Polyolester**

Specialty Chemical POE is custom formulated for use in refrigeration compressors. This series contains no ozone depleting substances and is compatible with new HFC refrigerants as well as existing CFC and HCFC refrigerants. POE is also compatible with traditional mineral oil lubricants.



**POE32-32**

CATALOG NO.	DESCRIPTION	UOM	ORDER MULTIPLE
<b>POE32-32</b>	SUS150 ISO32 Pro-Lube-POE™ Polyolester – 1 Quart Can	EA	12
<b>POE32-01</b>	SUS150 ISO32 Pro-Lube-POE™ Polyolester – 1 Gallon Can	EA	6
<b>POE68-32</b>	SUS300 ISO68 Pro-Lube-POE™ Polyolester – 1 Quart Can	EA	12
<b>POE68-01</b>	SUS300 ISO68 Pro-Lube-POE™ Polyolester – 1 Gallon Can	EA	6
<b>POE100-32</b>	SUS500 ISO100 Pro-Lube-POE™ Polyolester – 1 Quart Can	EA	12
<b>POE100-01</b>	SUS500 ISO100 Pro-Lube-POE™ Polyolester – 1 Gallon Can	EA	6

**SYSTEM CLEANERS**

**D'Scale™ Acid Scale Remover for Cooling Towers**

D'Scale™ will not create corrosive acidic foam. D'Scale™ has pH indicating dye. The color changes to yellow when acid has been consumed. Each gallon dissolves 3 pounds of scale.



**D-SCALE**

CATALOG NO.	DESCRIPTION	UOM	ORDER MULTIPLE
<b>D-SCALE</b>	D'Scale™ Acid Scale Remover – 1 Gallon Container	EA	4

**TEST KITS, STRIPS, AND PREVENTION**

**Acid Test Kit™**

Detects acid in refrigeration oil. Convenient, one-step test means no chemicals to mix. Easy to evaluate. Color change indicates acidity; color intensity reveals the amount of acid present in the oil sample.



**ATK-1 ATK-1P**

CATALOG NO.	DESCRIPTION	UOM	ORDER MULTIPLE
<b>ATK-4</b>	Acid Test Kit™, pack of 4	EA	4
<b>ATK-1</b>	Acid Test Kit™	EA	1
<b>ATK-1P</b>	Acid Test Kit™ for POE Oil	EA	1

**Glycol Testing Strips**

DiversiTech's glycol test strip is used to measure the flow and/or burst rating of a system with glycol added. Differing types and concentrations of glycol provide different levels of protection for a system. This easy to use test strip shows what temperature your system is protected to.



**SCM-PG-TEST**

CATALOG NO.	DESCRIPTION	UOM	ORDER MULTIPLE
<b>SCM-PG-TEST</b>	Glycol Test Strip, pack of 10	PK	1

**THREAD SEALANTS**

**PRO-TITE™ Resin Based Thread Sealant**

Resin based thread sealant that adheres to internal surfaces, fills voids while forming a flexible fluid tight seal. Specifically formulated for use on metals and plastics subject to extreme vibration. Serviceable at temperatures from 100°F ( 73°C) to 400°F (204°C) and from full vacuum to 10,000 PSI. Pro Tite™ is impervious to most chemicals including refrigerants, petroleum products, gases, steam, etc. Alcohol based.



CATALOG NO.	DESCRIPTION	UOM	ORDER MULTIPLE
<b>CLL-1</b>	Pro-Tite™ Thread Sealant – 1-1/3 oz. Squeeze Tube	EA	12
<b>CLL-4</b>	Pro-Tite™ Thread Sealant – 4 oz. Brush Top	EA	12
<b>CLL-16</b>	Pro-Tite™ Thread Sealant – 16 oz. Brush Top	EA	12
<b>61028</b>	Pro-Tite™ Thread Sealant – 1 Gallon Can	EA	1

**VACUUM PUMP OIL**

**Pro-Lube-VAC™ Vacuum Pump Oil**

Specialty Chemical VP-68 Premium Vacuum Pump Oil is now based on a highly refined paraffinic based stock. This new improved formulation is lighter in color and provides better viscosity and oxidation stability than the previous formulation. VP-68 provides excellent cold start performance; formulated to meet minimum moisture content specifications.



CATALOG NO.	DESCRIPTION	UOM	ORDER MULTIPLE
<b>VP68-32</b>	Pro-Lube-VAC™ Vacuum Pump Oil – 1 Quart Jug	EA	12
<b>VP68-01</b>	Pro-Lube-VAC™ Vacuum Pump Oil – 1 Gallon Jug	EA	4
<b>VP68-05</b>	Pro-Lube-VAC™ Vacuum Pump Oil – 5 Gallon Pail	EA	1

**ADDITIVES**

**Acid Eliminator**

Keeps acid away; compatible with all refrigerants and oils. Chemically neutralizes and prevents acids that are formed in air conditioning and refrigeration systems due to refrigerant and refrigeration oil break-down, moisture, and compressor burnout. Easy-to-use, no complicated charts. Works fast, circulates quickly, and leaves no solids or solid residuals. Will not harm system components. Can prevent system breakdown.



CATALOG NO.	DESCRIPTION	UOM	ORDER MULTIPLE
<b>ACID-ELIM</b>	Acid Eliminator – 4 oz. Plastic Bottle	EA	12

**Pro-Thaw™ Liquid Dryer for Refrigerants**

Chemically dries all refrigerants (R-12, R-22, R-134a, etc.), methyl chloride and methylene chloride. Frees up systems frozen due to moisture contamination in 5 minutes and prevents refreezing. Does not contain any dissolved solids, leaves no residue and works with or without solid dryers.



CATALOG NO.	DESCRIPTION	UOM	ORDER MULTIPLE
<b>PRO-THAW-1</b>	Pro-Thaw™ – 1 oz. Plastic Bottle	EA	24
<b>PRO-THAW</b>	Pro-Thaw™ – 4 oz. Plastic Bottle	EA	12

**Glycol Inhibitors**

Extend the service life of glycols with Pro-Tek™ Inhibitor. Pro-Tek™ Inhibitor is a glycol corrosion inhibitor additive designed for use in both propylene and ethylene glycol heat transfer/antifreeze solutions. Pro-Tek™ Inhibitor extends the glycol service life by restoring residual alkalinity and neutralization of acids. Pro-Tek™ Inhibitor is both non-toxic and food safe.



CATALOG NO.	DESCRIPTION	UOM	ORDER MULTIPLE
<b>SCM-117-16</b>	Glycol Corrosion Inhibitor Additive – 16 oz.	EA	12

**LineSeal™ Refrigerant Line Sealant**

LineSeal™ is a patented, contaminate free sealing solution for refrigerant systems. Seals leaks and provides years of protection against future leaks. LineSeal™ is a self-contained vacuum packed canister of sealant that is released into a refrigerant system. The sealant travels with the oil and refrigerant throughout the system. Where the system leaks, the refrigerant escapes and lowers the surrounding air temperature down to the dew point where micro droplets of water are deposited around the perimeter of the leak area. The sealant reacts with the droplets of water to harden into a protective barrier to keep refrigerant from escaping. Unlike many sealant products, LineSeal™ uses no harmful hydrocarbon (propane or butane) chemicals, assuring that the system remains safe and contaminate free.



- Stops existing and future leaks
- Contains no propane or butane
- Patented Technology
- Compatible with all oils and refrigerants

CATALOG NO.	DESCRIPTION	UOM	ORDER MULTIPLE
<b>LS-1</b>	LineSeal™, 1 ounce can, up to 1.5 ton (18k BTU) (5 kW)	EA	6
<b>LS-2</b>	LineSeal™, 3 ounce can, 1.5 to 5 ton (18-60k BTU) (5-17 kW)	EA	6

# Triple-D™

## Universal Coil Cleaner™

Triple-D™ is a Universal Coil Cleaner™ suitable for use on condenser and evaporator coils. It is metal safe and does not attack aluminum or copper coil components, extending equipment life and diminishing potential for refrigerant leaks. Triple-D™ is a safer, more versatile product than conventional acid or non-acid coil cleaners.

All of the organic materials in this product are readily biodegradable

**BIODEGRADABLE**

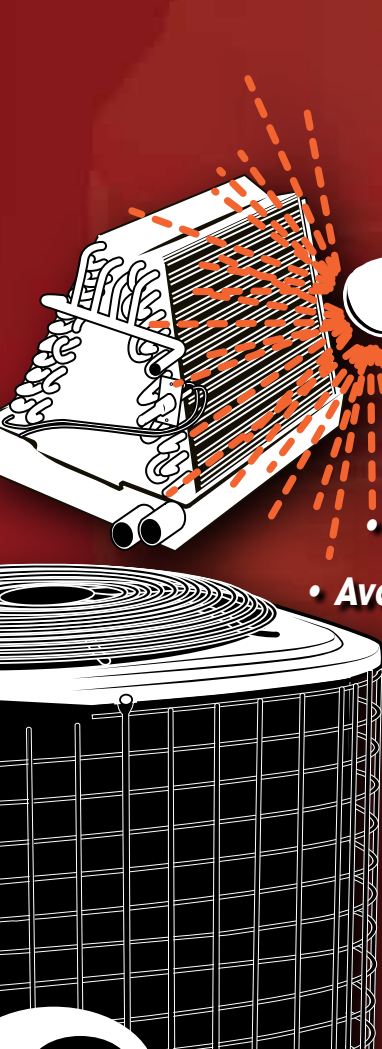

- Metal Safe
- Biodegradable
- Super Concentrated
- Inhibited Non-Acid Formulation
- Available in Multiple Packages/Forms
- Non-Foaming/Non-Toxic
- Safe for Rubber Roofs
- Corrosion Inhibited
- NSF Registered



See why you should use Triple-D™

**One product does it all — truly a Universal Coil Cleaner™**

# INLINE COMPONENTS

Access Fittings .....	240
Brass Fittings.....	242-244
Copper Fittings .....	236-239
Cushion Clamps .....	244
Driers, Sight Glasses .....	245-246
Line Piercing Valves and Tools .....	241
Line Sets .....	247
Refrigerant Charging.....	246
Refrigerant Labels.....	248
Refrigerant Recovery Products .....	248
Tubing Insulation .....	249



**COPPER FITTINGS**

**Male Adapter C x M**



CATALOG NO.	O.D. SIZE	I.D. SIZE	UOM	ORDER MULTIPLE
C101-0025	1/2" x 3/8"	3/8" x 3/8"	EA	25
C101-0050	5/8" x 1/2"	1/2" x 1/2"	EA	25
C101-0057	5/8" x 3/4"	1/2" x 3/4"	EA	25
C101-0058	5/8" x 3/8"	1/2" x 3/8"	EA	50
C101-0100	7/8" x 3/4"	3/4" x 3/4"	EA	25
C101-0107	7/8" x 1/2"	3/4" x 1/2"	EA	25
C101-0150	1-1/8" x 1"	1" x 1"	EA	10
C101-0159	1-1/8" x 3/4"	1" x 3/4"	EA	10
C101-0215	1-3/8" x 1-1/4"	1-1/4" x 1-1/4"	EA	10
C101-0222	1-3/8" x 1"	1-1/4" x 1"	EA	10
C101-0295	1-5/8" x 1-1/2"	1-1/2" x 1-1/2"	EA	10
C101-0390	2-1/8" x 2"	2" x 2"	EA	5

**Male Adapter Fig. x M**



CATALOG NO.	O.D. SIZE	I.D. SIZE	UOM	ORDER MULTIPLE
C114-0050	5/8" x 1/2"	1/2" x 1/2"	EA	25
C114-0100	7/8" x 3/4"	3/4" x 3/4"	EA	25
C114-0150	1-1/8" x 1"	1" x 1"	EA	10
C114-0215	1-3/8" x 1-1/4"	1-1/4" x 1-1/4"	EA	80
C114-0295	1-5/8" x 1-1/2"	1-1/2" x 1-1/2"	EA	50
C114-0390	2-1/8" x 2"	2" x 2"	EA	38

**90 Degree Ell C x C**



CATALOG NO.	O.D. SIZE	I.D. SIZE	UOM	ORDER MULTIPLE
C235-0002	3/8"	1/4"	EA	25
C235-0025	1/2"	3/8"	EA	25
C235-0050	5/8"	1/2"	EA	25
C235-0090	3/4"	5/8"	EA	25
C235-0100	7/8"	3/4"	EA	25
C235-0150	1-1/8"	1"	EA	10
C235-0215	1-3/8"	1-1/4"	EA	50
C235-0295	1-5/8"	1-1/2"	EA	35
C235-0390	2-1/8"	2"	EA	17

**Female Adapter C x F**



CATALOG NO.	O.D. SIZE	I.D. SIZE	UOM	ORDER MULTIPLE
C105-0050	5/8" x 1/2"	1/2" x 1/2"	EA	25
C105-0057	5/8" x 3/4"	1/2" x 3/4"	EA	25
C105-0058	5/8" x 3/8"	1/2" x 3/8"	EA	25
C105-0100	7/8" x 3/4"	3/4" x 3/4"	EA	25
C105-0107	7/8" x 1/2"	3/4" x 1/2"	EA	25
C105-0150	1-1/8" x 1"	1" x 1"	EA	10
C105-0159	1-1/8" x 3/4"	1" x 3/4"	EA	10
C105-0215	1-3/8" x 1-1/4"	1-1/4" x 1-1/4"	EA	10
C105-0295	1-5/8" x 1-1/2"	1-1/2" x 1-1/2"	EA	5
C105-0390	2-1/8" x 2"	2" x 2"	EA	30

**Female Adapter Fig. x F**



CATALOG NO.	O.D. SIZE	UOM	ORDER MULTIPLE
C115-0050	5/8" x 1/2"	EA	25
C115-0100	7/8" x 3/4"	EA	25
C115-0150	1-1/8" x 1"	EA	10
C115-0215	1-3/8" x 1-1/4"	EA	85
C115-0295	1-5/8" x 1-1/2"	EA	80
C115-0390	2-1/8" x 2"	EA	40

**90 Degree Long Turn Street Ell Fig. x C**



CATALOG NO.	O.D. SIZE	I.D. SIZE	UOM	ORDER MULTIPLE
C272-0002	3/8"	1/4"	EA	25
C272-0025	1/2"	3/8"	EA	25
C272-0050	5/8"	1/2"	EA	25
C272-0090	3/4"	5/8"	EA	25
C272-0100	7/8"	3/4"	EA	10
C272-0150	1-1/8"	1"	EA	10
C272-0215	1-3/8"	1-1/4"	EA	35
C272-0295	1-5/8"	1-1/2"	EA	25

**90 Degree Street Ell Ftg. x C**



C254-0100

CATALOG NO.	O.D. SIZE	I.D. SIZE	UOM	ORDER MULTIPLE
C254-0002	3/8"	1/4"	EA	25
C254-0025	1/2"	3/8"	EA	25
C254-0050	5/8"	1/2"	EA	25
C254-0090	3/4"	5/8"	EA	25
C254-0100	7/8"	3/4"	EA	25
C254-0150	1-1/8"	1"	EA	10
C254-0215	1-3/8"	1-1/4"	EA	50
C254-0295	1-5/8"	1-1/2"	EA	35
C254-0390	2-1/8"	2"	EA	18

**45 Degree Ell C x C**



C290-0050

CATALOG NO.	O.D. SIZE	I.D. SIZE	UOM	ORDER MULTIPLE
C290-0002	3/8"	1/4"	EA	25
C290-0025	1/2"	3/8"	EA	25
C290-0050	5/8"	1/2"	EA	25
C290-0090	3/4"	5/8"	EA	25
C290-0100	7/8"	3/4"	EA	25
C290-0150	1-1/8"	1"	EA	10
C290-0215	1-3/8"	1-1/4"	EA	60
C290-0295	1-5/8"	1-1/2"	EA	40
C290-0390	2-1/8"	2"	EA	18

**90 Degree Long Turn Ell C x C**



C242-0015

CATALOG NO.	O.D. SIZE	I.D. SIZE	UOM	ORDER MULTIPLE
C242-0001	1/4"	1/8"	EA	25
C242-0002	3/8"	1/4"	EA	25
C242-0015	5/16"	1/4"	EA	25
C242-0025	1/2"	3/8"	EA	25
C242-0050	5/8"	1/2"	EA	25
C242-0090	3/4"	5/8"	EA	25
C242-0100	7/8"	3/4"	EA	10
C242-0150	1-1/8"	1"	EA	10
C242-0215	1-3/8"	1-1/4"	EA	35
C242-0295	1-5/8"	1-1/2"	EA	25
C242-0390	2-1/8"	2"	EA	12

**45 Degree Street Ell Ftg. x C**



C295-0090

CATALOG NO.	O.D. SIZE	I.D. SIZE	UOM	ORDER MULTIPLE
C295-0002	3/8"	1/4"	EA	25
C295-0025	1/2"	3/8"	EA	25
C295-0050	5/8"	1/2"	EA	25
C295-0090	3/4"	5/8"	EA	25
C295-0100	7/8"	3/4"	EA	25
C295-0150	1-1/8"	1"	EA	10
C295-0215	1-3/8"	1-1/4"	EA	60
C295-0295	1-5/8"	1-1/2"	EA	40
C295-0390	2-1/8"	2"	EA	18

**Coupling (Socket) with Rolled Tube Stop C x C**



C165-0090

CATALOG NO.	O.D. SIZE	I.D. SIZE	UOM	ORDER MULTIPLE
C165-0001	1/4"	1/8"	EA	25
C165-0002	3/8"	1/4"	EA	25
C165-0025	1/2"	3/8"	EA	25
C165-0050	5/8"	1/2"	EA	25
C165-0090	3/4"	5/8"	EA	25
C165-0100	7/8"	3/4"	EA	25
C165-0150	1-1/8"	1"	EA	10
C165-0215	1-3/8"	1-1/4"	EA	100
C165-0295	1-5/8"	1-1/2"	EA	60
C165-0390	2-1/8"	2"	EA	40

**COPPER FITTINGS cont'd**

**Fitting Reducer Coupling  
Ftg. x C**



**C410-0093**

CATALOG NO.	O.D. SIZE	I.D. SIZE	UOM	ORDER MULTIPLE
C410-0007	3/8" x 1/4"	1/4" x 1/8"	EA	25
C410-0032	1/2" x 3/8"	3/8" x 1/4"	EA	25
C410-0033	1/2" x 1/4"	3/8" x 1/8"	EA	25
C410-0058	5/8" x 1/2"	1/2" x 3/8"	EA	25
C410-0059	5/8" x 3/8"	1/2" x 1/4"	EA	25
C410-0093	3/4" x 5/8"	5/8" x 1/2"	EA	25
C410-0107	7/8" x 5/8"	3/4" x 1/2"	EA	25
C410-0149	7/8" x 3/4"	3/4" x 5/8"	EA	25
C410-0159	1-1/8" x 7/8"	1" x 3/4"	EA	10
C410-1498	1-1/8" x 3/4"	1" x 5/8"	EA	10
C410-0160	1-1/8" x 5/8"	1" x 1/2"	EA	10
C410-0161	1-1/8" x 1/2"	1" x 3/8"	EA	10
C410-0222	1-3/8" x 1-1/8"	1-1/4" x 1"	EA	100
C410-0223	1-3/8" x 7/8"	1-1/4" x 3/4"	EA	100
C410-0224	1-3/8" x 5/8"	1-1/4" x 1/2"	EA	100
C410-0303	1-5/8" x 1-3/8"	1-1/2" x 1-1/4"	EA	100
C410-0304	1-5/8" x 1-1/8"	1-1/2" x 1"	EA	100
C410-0305	1-5/8" x 7/8"	1-1/2" x 3/4"	EA	100
C410-0306	1-5/8" x 5/8"	1-1/2" x 1/2"	EA	100
C410-0398	2-1/8" x 1-5/8"	2" x 1-1/2"	EA	50
C410-0399	2-1/8" x 1-3/8"	2" x 1-1/4"	EA	50
C410-0400	2-1/8" x 1-1/8"	2" x 1"	EA	50
C410-0401	2-1/8" x 7/8"	2" x 3/4"	EA	50
C410-0402	2-1/8" x 5/8"	2" x 1/2"	EA	50

**Cap**



**C154-0090**

CATALOG NO.	O.D. SIZE	I.D. SIZE	UOM	ORDER MULTIPLE
C154-0002	3/8"	1/4"	EA	25
C154-0025	1/2"	3/8"	EA	25
C154-0050	5/8"	1/2"	EA	25
C154-0090	3/4"	5/8"	EA	25
C154-0100	7/8"	3/4"	EA	25
C154-0150	1-1/8"	1"	EA	10
C154-0215	1-3/8"	1-1/4"	EA	200
C154-0295	1-5/8"	1-1/2"	EA	5

**Reducer Coupling  
w/Stop C x C**



**C165-0223**

CATALOG NO.	O.D. SIZE	I.D. SIZE	UOM	ORDER MULTIPLE
C165-0007	3/8" x 1/4"	1/4" x 1/8"	EA	25
C165-0032	1/2" x 3/8"	3/8" x 1/4"	EA	25
C165-0058	5/8" x 1/2"	1/2" x 3/8"	EA	25
C165-0059	5/8" x 3/8"	1/2" x 1/4"	EA	25
C165-0093	3/4" x 5/8"	5/8" x 1/2"	EA	25
C165-0094	3/4" x 1/2"	5/8" x 3/8"	EA	25
C165-0107	7/8" x 5/8"	3/4" x 1/2"	EA	25
C165-0149	7/8" x 3/4"	3/4" x 5/8"	EA	25
C165-0159	1-1/8" x 7/8"	1" x 3/4"	EA	10
C165-1498	1-1/8" x 3/4"	1" x 5/8"	EA	10
C165-0222	1-3/8" x 1-1/8"	1-1/4" x 1"	EA	100
C165-0223	1-3/8" x 7/8"	1-1/4" x 3/4"	EA	100
C165-0224	1-3/8" x 5/8"	1-1/4" x 1/2"	EA	100
C165-0303	1-5/8" x 1-3/8"	1-1/2" x 1-1/4"	EA	100
C165-0304	1-5/8" x 1-1/8"	1-1/2" x 1"	EA	100
C165-0305	1-5/8" x 7/8"	1-1/2" x 3/4"	EA	100
C165-0306	1-5/8" x 5/8"	1-1/2" x 1/2"	EA	100
C165-0398	2-1/8" x 1-5/8"	2" x 1-1/2"	EA	50
C165-0399	2-1/8" x 1-3/8"	2" x 1-1/4"	EA	50
C165-0400	2-1/8" x 1-1/8"	2" x 1"	EA	50
C165-0401	2-1/8" x 7/8"	2" x 3/4"	EA	50
C165-0402	2-1/8" x 3/4"	2" x 5/8"	EA	50

**Union C x Brass**



**C657-0100**

CATALOG NO.	O.D. SIZE	I.D. SIZE	UOM	ORDER MULTIPLE
C657-0100	7/8"	3/4"	EA	100

**Flush Bushing**



**C142-0057**

CATALOG NO.	O.D. SIZE	I.D. SIZE	UOM	ORDER MULTIPLE
C142-0057	5/8" x 1/8"	1/2" x 1/8"	EA	25
C142-0058	5/8" x 1/4"	1/2" x 1/4"	EA	25



U-Type Strap



CATALOG NO.	O.D. SIZE	I.D. SIZE	UOM	ORDER MULTIPLE
C947-0025	1/2"	3/8"	EA	100
C947-0050	5/8"	1/2"	EA	25
C947-0090	3/4"	5/8"	EA	25
C947-0100	7/8"	3/4"	EA	25
C947-0150	1-1/8"	1"	EA	100
C947-0215	1-3/8"	1-1/4"	EA	100
C947-0295	1-5/8"	1-1/2"	EA	100
C947-0390	2-1/8"	2"	EA	50

Copper Coupling with No Stop



CATALOG NO.	O.D. SIZE	I.D. SIZE	UOM	ORDER MULTIPLE
C172-0050	5/8"	1/2"	EA	25
C172-0100	7/8"	3/4"	EA	25
C172-0150	1-1/8"	1"	EA	10
C172-0215	1-3/8"	1-1/4"	EA	10

Copper Coupling w/Dimple Stop



CATALOG NO.	O.D. SIZE	I.D. SIZE	UOM	ORDER MULTIPLE
C170-0003	5/16"	1/4"	EA	25

P-Traps



CATALOG NO.	O.D. SIZE	I.D. SIZE	UOM	ORDER MULTIPLE
C533-0050	5/8"	1/2"	EA	5
C533-0150	1-1/8"	1"	EA	3
C533-0215	1-3/8"	1-1/4"	EA	2
C533-0295	1-5/8"	1-1/2"	EA	2
C533-0390	2-1/8"	2"	EA	1

Tee C x C x C



CATALOG NO.	O.D. SIZE	I.D. SIZE	UOM	ORDER MULTIPLE
C460-0002	3/8"	1/4"	EA	25
C460-0025	1/2"	3/8"	EA	25
C460-0050	5/8"	1/2"	EA	25
C460-0090	3/4"	5/8"	EA	25
C460-0100	7/8"	3/4"	EA	10
C460-0150	1-1/8"	1"	EA	10
C460-0215	1-3/8"	1-1/4"	EA	35
C460-0295	1-5/8"	1-1/2"	EA	20
C460-0390	2-1/8"	2"	EA	10

Reducing Tee C x C x C



CATALOG NO.	O.D. SIZE	I.D. SIZE	UOM	ORDER MULTIPLE
C460-0057	5/8" x 5/8" x 7/8"	1/2" x 1/2" x 5/8"	EA	10
C460-0058	5/8" x 5/8" x 1/2"	1/2" x 1/2" x 3/8"	EA	25
C460-0107	7/8" x 7/8" x 5/8"	3/4" x 3/4" x 1/2"	EA	10
C460-0117	7/8" x 5/8" x 7/8"	3/4" x 1/2" x 3/4"	EA	10
C460-0118	7/8" x 5/8" x 5/8"	5/8" x 1/2" x 1/2"	EA	10
C460-0159	1-1/8" x 1-1/8" x 7/8"	1" x 1" x 3/4"	EA	10
C460-0160	1-1/8" x 1-1/8" x 5/8"	1" x 1" x 1/2"	EA	10
C460-0180	1-1/8" x 5/8" x 1-1/8"	1" x 1/2" x 1"	EA	10
C460-0181	1-1/8" x 5/8" x 7/8"	1" x 1/2" x 3/4"	EA	10
C460-0182	1-1/8" x 5/8" x 5/8"	1" x 1/2" x 1/2"	EA	10
C460-0222	1-3/8" x 1-3/8" x 1-1/8"	1-1/4" x 1-1/4" x 1"	EA	40
C460-0223	1-3/8" x 1-3/8" x 7/8"	1-1/4" x 1-1/4" x 3/4"	EA	50
C460-0235	1-3/8" x 1-1/8" x 1-1/8"	1-1/4" x 1" x 1"	EA	50
C460-0236	1-3/8" x 1-1/8" x 7/8"	1-1/4" x 1" x 3/4"	EA	50
C460-0237	1-3/8" x 1-1/8" x 5/8"	1-1/4" x 1" x 3/4"	EA	50
C460-0245	1-3/8" x 7/8" x 1-3/8"	1-1/4" x 5/8" x 1-1/4"	EA	35
C460-0246	1-3/8" x 7/8" x 1-1/8"	1-1/4" x 5/8" x 1"	EA	50
C460-0247	1-3/8" x 7/8" x 7/8"	1-1/4" x 5/8" x 5/8"	EA	50
C460-0248	1-3/8" x 7/8" x 5/8"	1-1/4" x 5/8" x 1/2"	EA	50
C460-0256	1-3/8" x 5/8" x 1-3/8"	1-1/4" x 1/2" x 1-1/4"	EA	35
C460-0303	1-5/8" x 1-5/8" x 1-3/8"	1-1/2" x 1-1/2" x 1-1/4"	EA	25
C460-0304	1-5/8" x 1-5/8" x 1-1/8"	1-1/2" x 1-1/2" x 1"	EA	30
C460-0305	1-5/8" x 1-5/8" x 7/8"	1-1/2" x 1-1/2" x 3/4"	EA	35
C460-0315	1-5/8" x 1-3/8" x 1-5/8"	1-1/2" x 1-1/4" x 1-1/2"	EA	20
C460-0316	1-5/8" x 1-3/8" x 1-3/8"	1-1/2" x 1-1/4" x 1-1/4"	EA	20
C460-0317	1-5/8" x 1-3/8" x 1-1/8"	1-1/2" x 1-1/4" x 1"	EA	30
C460-0318	1-5/8" x 1-3/8" x 7/8"	1-1/2" x 1-1/4" x 3/4"	EA	40
C460-0319	1-5/8" x 1-3/8" x 5/8"	1-1/2" x 1-1/4" x 1/2"	EA	40
C460-0329	1-5/8" x 1-1/8" x 1-3/8"	1-1/2" x 1" x 1-1/4"	EA	30
C460-0330	1-5/8" x 1-1/8" x 1-1/8"	1-1/2" x 1" x 1"	EA	35
C460-0331	1-5/8" x 1-1/8" x 7/8"	1-1/2" x 1" x 5/8"	EA	5
C460-0332	1-5/8" x 1-1/8" x 5/8"	1-1/2" x 1" x 1/2"	EA	40
C460-0339	1-5/8" x 7/8" x 1-5/8"	1-1/2" x 5/8" x 1-1/2"	EA	20
C460-0340	1-5/8" x 7/8" x 1-3/8"	1-1/2" x 5/8" x 1-1/4"	EA	30
C460-0341	1-5/8" x 7/8" x 1-1/8"	1-1/2" x 5/8" x 1"	EA	40
C460-0342	1-5/8" x 7/8" x 7/8"	1-1/2" x 5/8" x 5/8"	EA	40
C460-0343	1-5/8" x 7/8" x 5/8"	1-1/2" x 5/8" x 1/2"	EA	40
C460-0350	1-5/8" x 5/8" x 1-5/8"	1-1/2" x 1/2" x 1-1/2"	EA	20
C460-0398	2-1/8" x 2-1/8" x 1-5/8"	2" x 2" x 1-1/2"	EA	10
C460-0399	2-1/8" x 2-1/8" x 1-3/8"	2" x 2" x 1-1/4"	EA	15
C460-0400	2-1/8" x 2-1/8" x 1-1/8"	2" x 2" x 1"	EA	18
C460-0401	2-1/8" x 2-1/8" x 7/8"	2" x 2" x 5/8"	EA	20
C460-0402	2-1/8" x 2-1/8" x 5/8"	2" x 2" x 3/8"	EA	20
C460-0413	2-1/8" x 1-5/8" x 2-1/8"	2" x 1-1/2" x 2"	EA	10
C460-0414	2-1/8" x 1-5/8" x 1-5/8"	2" x 1-1/2" x 1-1/2"	EA	10
C460-0415	2-1/8" x 1-5/8" x 1-3/8"	2" x 1-1/2" x 1-1/4"	EA	10
C460-0416	2-1/8" x 1-5/8" x 1-1/8"	2" x 1-1/2" x 1"	EA	10
C460-0417	2-1/8" x 1-5/8" x 7/8"	2" x 1-1/2" x 3/4"	EA	20
C460-0418	2-1/8" x 1-5/8" x 5/8"	2" x 1-1/2" x 1/2"	EA	20
C460-0429	2-1/8" x 1-3/8" x 2-1/8"	2" x 1-1/4" x 2"	EA	10
C460-0430	2-1/8" x 1-3/8" x 1-5/8"	2" x 1-1/4" x 1-1/2"	EA	15
C460-0431	2-1/8" x 1-3/8" x 1-3/8"	2" x 1-1/4" x 1-1/4"	EA	15
C460-0432	2-1/8" x 1-3/8" x 1-1/8"	2" x 1-1/4" x 1"	EA	20
C460-0433	2-1/8" x 1-3/8" x 7/8"	2" x 1-1/4" x 3/4"	EA	20
C460-0444	2-1/8" x 1-1/8" x 2-1/8"	2" x 1" x 2"	EA	15
C460-0447	2-1/8" x 1-1/8" x 1-1/8"	2" x 1" x 1"	EA	20
C460-0457	2-1/8" x 7/8" x 2-1/8"	2" x 5/8" x 2"	EA	10
C460-0470	2-1/8" x 5/8" x 2-1/8"	2" x 1/2" x 2"	EA	15

**ACCESS FITTINGS**

A convenient low-cost port for refrigeration servicing. May be installed in any position on either high or low side for charging, purging, quick testing or pressure checking. DiversiTech's access fittings have 1/4" SAE male flare access ports and include a quick seal cap and a stainless and brass special refrigerant valve core.

CATALOG NO.	DESCRIPTION	CONNECTION	UOM	ORDER MULTIPLE
<b>VA-3-346</b>	3 Way Solder Type, pack of 6	For 3/16" O.D. tube or 1/4" and 3/8" solder fitting	PK	1
<b>VA-34</b>	Straight Solder Type, pack of 6	3/16" O.D.S. x 1/4" O.D.F.	PK	1
<b>VA-46</b>	Straight Solder Type, pack of 6	1/4" O.D.S. x 3/8" O.D.F.	PK	1
<b>VA-68</b>	Straight Solder Type, pack of 6	3/8" O.D.S. x 1/2" O.D.F.	PK	1
<b>VAU-24</b>	Half Union, pack of 6	1/8" MPT	PK	1
<b>VAU-45</b>	Half Union, pack of 6	1/4" MPT	PK	1
<b>VAX-2</b>	Extended Copper Tube	1/8" O.D. tube	PK	1
<b>VAX-3</b>	Extended Copper Tube	3/16" O.D. x 1/8" I.D.	PK	1
<b>VAX-4</b>	Extended Copper Tube	1/4" O.D. x 3/16" I.D.	PK	1
<b>VAX-5</b>	Extended Copper Tube	5/16" O.D. x 1/4" I.D.	PK	1
<b>VAX-6</b>	Extended Copper Tube	3/8" O.D. x 5/16" I.D.	PK	1
<b>VAX-8</b>	Extended Copper Tube	1/2" O.D.	PK	1
<b>VE-2</b>	Threaded Elbow, pack of 3	1/8" MPT	PK	1
<b>VS-4</b>	Swivel Nut w/Depressor, pack of 6	1/4" female flare forged swivel nut	PK	1
<b>VST-4</b>	Swivel Tee w/Permanent Depressor, pack of 3	1/4" Access on run x 1/4" female flare w/depressor on female swivel branch end	PK	1
<b>VST-44</b>	Swivel Tee w/Permanent Depressor, pack of 3	1/4" Access on run x 1/4" access on "T" - female swivel on run	PK	1
<b>VT-4</b>	Forged Brass Tee, pack of 3	1/4" Access all ends with 2 flare nuts, 1 core and cap	PK	1
<b>VT-24</b>	Threaded Tee, pack of 3	1/8" MPT on branch, 1/4" flare x 1/4" flare access on run	PK	1
<b>VTR-24</b>	Threaded Tee, pack of 3	1/8" MPT x 1/4" male flare on run x access on branch	PK	1
<b>VTS-10</b>	Solder Tee Type	5/8" O.D. tube	EA	1
<b>VTS-12</b>	Solder Tee Type	3/4" O.D. tube	EA	1
<b>VTS-14</b>	Solder Tee Type	7/8" O.D. tube	EA	1
<b>VTS-18</b>	Solder Tee Type	1-1/8" O.D. tube	EA	1
<b>VTS-46</b>	Solder Tee Type, pack of 3	1/4" O.D.S. x 5/16" O.D.F.	PK	1
<b>VTS-56</b>	Solder Tee Type, pack of 3	5/16" O.D.S. x 3/8" O.D.F.	PK	1
<b>VTS-68</b>	Solder Tee Type, pack of 3	3/8" O.D.S.	PK	1
<b>VTS-810</b>	Solder Tee Type, pack of 3	1/2" O.D.S.	PK	1
<b>VTS-3-10</b>	Solder Tube Elbow	5/8" O.D.S.	EA	1
<b>VTS-3-12</b>	Solder Tube Elbow	3/4" O.D.S.	EA	1
<b>VTS-3-14</b>	Solder Tube Elbow	7/8" O.D.S.	EA	1
<b>VTS-3-18</b>	Solder Tube Elbow	1-1/8" O.D.S.	EA	1
<b>VC-4</b>	Flare Cap, pack of 12	1/4"	PK	1
<b>VC-4R</b>	Flare Cap w/Core Remover, pack of 12	1/4"	PK	1
<b>VVC-1</b>	Valve Core, pack of 6		PK	1



**Brass Adapters**

The MSA-45 is used on the new R410 Mini Split systems that have the larger unique fitting on the service valve. The description of that fitting is 1/2" acme Male-20 UN. This adapter will screw onto the 1/2" Acme Male-20 UN fitting and allow you to connect a standard 1/4 service hose to it.



CATALOG NO.	DESCRIPTION	UOM	ORDER MULTIPLE
<b>MSA-45</b>	1/4" Male flare x 1/2" - 20 UNF Female	EA	1
<b>MSA-44</b>	1/4" Female flare swivel w/depressor tip and seal x 1/4" MPT, pack of 2	PK	1
<b>MSA-4545</b>	45° 1/4" Male flare x 1/2" - 20 UNF Female	EA	1

**Cop-Cap™ Locking Valve Cover**

An effective way to discourage and prevent the removal of refrigerant. COP-CAP™ fits this standard service valve on all central AC units and mini-splits. It helps prevent access by unauthorized persons and can only be removed with the included special tool. Simply thread COP-CAP™ assembly onto existing 1/4" flare connection on system and lock set screw in place with hex wrench provided.

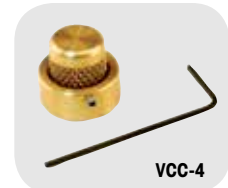

- Seals service valve to prevent leaks
- Prevents illegal venting or theft of refrigerant
- Stops unauthorized access in unsecured areas

CATALOG NO.	DESCRIPTION	UOM	ORDER MULTIPLE
<b>VCC-4</b>	Cop-Cap™, Pack of 2	PK	1
<b>VCC-4B</b>	Cop-Cap™ bulk, 100 per case	EA	100

**LINE PIERCING VALVES AND TOOLS**

**Quick-Tap**

Features a valve core in the 1/4" male port. Simply pierce the line and back seat the needle. Flow starts when depressor type charging hose is connected. Flow shuts off automatically when hose is removed. If valve core is not desired, it may be removed. Connect hose, pierce line and back seat needle. This method offers full unrestricted flow. Valve core can be removed or changed at any time without loss of refrigerant if needle is front seated.



CATALOG NO.	DESCRIPTION	UOM	ORDER MULTIPLE
QT-1	Quick-Tap – 1/4", 5/16", 3/8" O.D. Tube Size	EA	1
QT-2	Quick-Tap – 1/2", 5/8" O.D. Tube Size	EA	1

**MAC—The Ultimate in Line Piercing Valves**

Install valve. Connect charging hose. Service. That's all there is to it! MAC features uniport: 1 connection for piercing and servicing. Sealed with refrigerant resistant "O" rings. Needle automatically back seats after servicing, leaving line free of restriction. Connect to tubing with 2 socket-head screws. (Hex wrench is included with each valve.) Needle depressor is inserted into head of needle. Wing cap is turned down easily by hand until line is pierced. Wing cap is removed and system may be serviced with any charging hose with built-in depressor. When hose is removed, spring loaded needle back-seats forming a leak proof seal. Needle depressor is discarded and wing cap forms extra precautionary seal.



CATALOG NO.	DESCRIPTION	UOM	ORDER MULTIPLE
QTM-1	MAC Line Piercing Valve – 1/4", 5/16", 3/8" O.D. Tube Size	EA	36
QTM-2	MAC Line Piercing Valve – 1/2", 5/8" O.D. Tube Size	EA	36
QTM-3	MAC Line Piercing Valve – 3/16", 1/4" O.D. Tube Size	EA	36

**Copper Saddle Valve**

For copper-to-copper brazing. Penetrates line in one easy operation with no holes to drill. Steel pin with valve core pierces line and is locked into valve body by tightening cap. Teflon ring assures positive seal. Available in sizes from 1/4" to 1-1/8".



CATALOG NO.	DESCRIPTION	UOM	ORDER MULTIPLE
VLC-4	Copper Saddle Valve – 1/4" O.D. Tube Size, pack of 6	PK	1
VLC-5	Copper Saddle Valve – 5/16" O.D. Tube Size, pack of 6	PK	1
VLC-6	Copper Saddle Valve – 3/8" O.D. Tube Size, pack of 6	PK	1
VLC-8	Copper Saddle Valve – 1/2" O.D. Tube Size, pack of 4	PK	1
VLC-10	Copper Saddle Valve – 5/8" O.D. Tube Size, pack of 3	PK	1
VLC-12	Copper Saddle Valve – 3/4" O.D. Tube Size, pack of 2	PK	1
VLC-18	Copper Saddle Valve – 1-1/8" O.D. Tube Size, pack of 2	PK	1
VLC-25	Additional Teflon Rings, pack of 25	PK	1

**Quick-Tap-2**

Identical to Quick-Tap except that a nylon handle replaces the hex wrench. Phillips-head screws are used.



CATALOG NO.	DESCRIPTION	UOM	ORDER MULTIPLE
QTH-1	Quick-Tap-2 – 1/4", 5/16", 3/8" O.D. Tube Size	EA	1
QTH-2	Quick-Tap-2 – 1/2", 5/8" O.D. Tube Size	EA	1

**Insta-Tap Refrigerant Recovery Tool**

The fastest, easiest way to evacuate refrigerant before disposal of a unit. Snaps onto refrigerant line for full and immediate flow. Punctures super large hole for maximum full flow discharge to recovery unit. One tool fits all sizes from 3/16" to 7/8" O.D. hard tubing. Replaceable needle.



CATALOG NO.	DESCRIPTION	UOM	ORDER MULTIPLE
QT-100	Quick-Tap-2 – 1/4", 5/16", 3/8" O.D. Tube Size	EA	1
QT-100N	Replaceable Hardened Steel Needle and Gasket	EA	1
QT-100G	Replacement Gasket Only	EA	3

**Core Storer**

All steel valve core remover and storage container. Completely knurled for easier grip, eliminating slippage when using with oily or greasy hands. Core Storer features a compartment for storing extra valve cores. Four replacement cores are included with each tool.



CATALOG NO.	DESCRIPTION	UOM	ORDER MULTIPLE
VCR-1	Core Remover and Storer	EA	1

**Core Removal Tool**

Designed to remove and replace valve cores without losing the refrigerant charge. Connects to any 1/4" male flare fitting. Saves time, saves refrigerant.



CATALOG NO.	DESCRIPTION	UOM	ORDER MULTIPLE
VCRT-1	Core Removal Tool	EA	1
VCRT-1R	Replacement Rod Assembly	EA	1
VCRT-1RK	Replacement O-ring Kit	EA	1
VCRT-1S	Replacement Shut-off Stem	EA	1

**BRASS FITTINGS**

**Compression Sleeve**



CATALOG NO.	DESCRIPTION	UOM	ORDER MULTIPLE
D60A-4	1/4" Compression Sleeve	EA	100
D60A-6	3/8" Compression Sleeve	EA	100
D60A-8	1/2" Compression Sleeve	EA	100
D60A-10	5/8" Compression Sleeve	EA	100

**Compression Nut**



CATALOG NO.	DESCRIPTION	UOM	ORDER MULTIPLE
D61A-4	1/4" Compression Nut	EA	10
D61A-6	3/8" Compression Nut	EA	10
D61A-8	1/2" Compression Nut	EA	10
D61A-10	5/8" Compression Nut	EA	10

**Compression Union**



CATALOG NO.	DESCRIPTION	UOM	ORDER MULTIPLE
D62A-44	1/4" Compression Union	EA	10
D62A-66	3/8" Compression Union	EA	10
D62A-88	1/2" Compression Union	EA	10
D62A-1010	5/8" Compression Union	EA	10

**Compression Connector**



CATALOG NO.	DESCRIPTION	UOM	ORDER MULTIPLE
D68A-4B	1/4" x 1/4" Compression Connector	EA	10
D68A-6C	3/8" x 3/8" Compression Connector	EA	10
D68A-8D	1/2" x 1/2" Compression Connector	EA	10
D68A-4A	1/4" x 1/8" Compression Connector	EA	10
D68A-6B	3/8" x 1/4" Compression Connector	EA	10
D68A-6D	3/8" x 1/2" Compression Connector	EA	10

**Compression Elbow**



CATALOG NO.	DESCRIPTION	UOM	ORDER MULTIPLE
D69A-4A	1/4" x 1/8" Compression Elbow	EA	10
D69A-4B	1/4" x 1/4" Compression Elbow	EA	10
D69A-6B	3/8" x 1/4" Compression Elbow	EA	10
D69A-6C	3/8" x 3/8" Compression Elbow	EA	10
D69A-6D	3/8" x 1/2" Compression Elbow	EA	10
D69A-8D	1/2" x 1/2" Compression Elbow	EA	10

**Compression Tee**



CATALOG NO.	DESCRIPTION	UOM	ORDER MULTIPLE
D64A-44	1/4" Compression Tee	EA	10
D64A-66	3/8" Compression Tee	EA	10
D64A-88	1/2" Compression Tee	EA	10
D64A-1010	5/8" Compression Tee	EA	10

### Flare x MIP Elbow



CATALOG NO.	DESCRIPTION	UOM	ORDER MULTIPLE
DE1-4B	1/4" Flare x 1/4" MIP Elbow	EA	10
DE1-6C	3/8" Flare x 3/8" MIP Elbow	EA	10
DE1-8D	1/2" Flare x 1/2" MIP Elbow	EA	10
DE1-12E	3/4" Flare x 3/4" MIP Elbow	EA	10

### Flare x MIP Reducing Elbow



CATALOG NO.	DESCRIPTION	UOM	ORDER MULTIPLE
DE1-6B	3/8" Flare x 1/4" MIP Reducing Elbow	EA	10
DE1-6D	3/8" Flare x 1/2" MIP Reducing Elbow	EA	10
DE1-8E	1/2" Flare x 3/4" MIP Reducing Elbow	EA	10
DE1-8C	1/2" Flare x 3/8" MIP Reducing Elbow	EA	10
DE1-10D	5/8" Flare x 1/2" MIP Reducing Elbow	EA	10
DE1-12D	3/4" Flare x 1/2" MIP Reducing Elbow	EA	10

### Short Nut



CATALOG NO.	DESCRIPTION	UOM	ORDER MULTIPLE
DN1-3	3/16" Short Nut	EA	10
DN1-4	1/4" Short Nut	EA	10
DN1-5	5/16" Short Nut	EA	10
DN1-6	3/8" Short Nut	EA	10
DN1-8	1/2" Short Nut	EA	10
DN1-10	5/8" Short Nut	EA	10
DN1-12	3/4" Short Nut	EA	10
DN1-14	7/8" Short Nut	EA	5

### Flare Tee



CATALOG NO.	DESCRIPTION	UOM	ORDER MULTIPLE
DT2-4	1/4" Flare Tee	EA	10
DT2-6	3/8" Flare Tee	EA	10
DT2-8	1/2" Flare Tee	EA	10
DT2-10	5/8" Flare Tee	EA	5

### Cap



CATALOG NO.	DESCRIPTION	UOM	ORDER MULTIPLE
DN5-4	1/4" Cap	EA	10
DN5-6	3/8" Cap	EA	10
DN5-8	1/2" Cap	EA	10
DN5-10	5/8" Cap	EA	10

### Flare x MIP Union



CATALOG NO.	DESCRIPTION	UOM	ORDER MULTIPLE
DU1-4A	1/4" Flare x 1/8" MIP Union	EA	10
DU1-4B	1/4" Flare x 1/4" MIP Union	EA	10
DU1-6B	3/8" Flare x 1/4" MIP Union	EA	10
DU1-6C	3/8" Flare x 3/8" MIP Union	EA	10
DU1-6D	3/8" Flare x 1/2" MIP Union	EA	10
DU1-6E	3/8" Flare x 3/4" MIP Union	EA	10
DU1-8B	1/2" Flare x 1/4" MIP Union	EA	10
DU1-8C	1/2" Flare x 3/8" MIP Union	EA	10
DU1-8D	1/2" Flare x 1/2" MIP Union	EA	10
DU1-8E	1/2" Flare x 3/4" MIP Union	EA	10
DU1-10D	5/8" Flare x 1/2" MIP Union	EA	10
DU1-10E	5/8" Flare x 3/4" MIP Union	EA	10
DU1-12D	3/4" Flare x 1/2" MIP Union	EA	10
DU1-12E	3/4" Flare x 3/4" MIP Union	EA	10

### Short Forged Flare Nut



CATALOG NO.	DESCRIPTION	UOM	ORDER MULTIPLE
DNS4-4	1/4" Short Forged Flare Nut	EA	10
DNS4-6	3/8" Short Forged Flare Nut	EA	10
DNS4-8	1/2" Short Forged Flare Nut	EA	10
DNS4-10	5/8" Short Forged Flare Nut	EA	10
DNS4-12	3/4" Short Forged Flare Nut	EA	10
DNS4-14	7/8" Short Forged Flare Nut	EA	5

**BRASS FITTINGS cont'd**

**Plug**



CATALOG NO.	DESCRIPTION	UOM	ORDER MULTIPLE
<b>DP2-4</b>	1/4" Plug	EA	10
<b>DP2-6</b>	3/8" Plug	EA	10
<b>DP2-8</b>	1/2" Plug	EA	10
<b>DP2-10</b>	5/8" Plug	EA	10

**Flare x FIP Union**



CATALOG NO.	DESCRIPTION	UOM	ORDER MULTIPLE
<b>DU3-6C</b>	3/8" x 3/8" Flare x FIP Union	EA	10
<b>DU3-6D</b>	3/8" x 1/2" Flare x FIP Union	EA	10
<b>DU3-8C</b>	1/2" x 3/8" Flare x FIP Union	EA	10
<b>DU3-8D</b>	1/2" x 1/2" Flare x FIP Union	EA	10
<b>DU3-10D</b>	5/8" x 1/2" Flare x FIP Union	EA	10
<b>DU3-10E</b>	5/8" x 3/4" Flare x FIP Union	EA	10

**Flare Union**

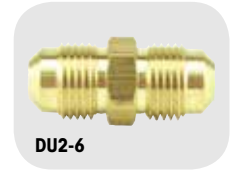

CATALOG NO.	DESCRIPTION	UOM	ORDER MULTIPLE
<b>DU2-4</b>	1/4" Flare Union	EA	10
<b>DU2-6</b>	3/8" Flare Union	EA	10
<b>DU2-8</b>	1/2" Flare Union	EA	10
<b>DU2-10</b>	5/8" Flare Union	EA	10
<b>DU2-12</b>	3/4" Flare Union	EA	10
<b>DU2-14</b>	7/8" Flare Union	EA	5

**Flare x Flare Swivel Union**



CATALOG NO.	DESCRIPTION	UOM	ORDER MULTIPLE
<b>DUS4-4</b>	1/4" Flare x 1/4" Flare Swivel Union	EA	10
<b>DUS4-6</b>	3/8" Flare x 3/8" Flare Swivel Union	EA	10
<b>DUS4-8</b>	1/2" Flare x 1/2" Flare Swivel Union	EA	10

**CUSHION CLAMPS**

**Cushion Clamps**

An industry standard universal clamp that mounts to standard strut. Steel with electro-dichromate finish to resist corrosion. The lock nut has a nylon insert for a positive lock. The polymeric grommet withstands temperatures from -25°C to 125°C and resists the effects of most oils, chemicals, and industrial cleaning compounds.



CATALOG NO.	DESCRIPTION	UOM	ORDER MULTIPLE
<b>538-1/4</b>	Cushion Clamp – 1/4"	EA	25
<b>538-3/8</b>	Cushion Clamp – 3/8"	EA	25
<b>538-1/2</b>	Cushion Clamp – 1/2"	EA	25
<b>538-5/8</b>	Cushion Clamp – 5/8"	EA	25
<b>538-3/4</b>	Cushion Clamp – 3/4"	EA	25
<b>538-7/8</b>	Cushion Clamp – 7/8"	EA	25
<b>538-1-1/8</b>	Cushion Clamp – 1-1/8"	EA	10
<b>538-1-3/8</b>	Cushion Clamp – 1-3/8"	EA	10
<b>538-1-5/8</b>	Cushion Clamp – 1-5/8"	EA	10
<b>538-2-1/8</b>	Cushion Clamp – 2-1/8"	EA	10
<b>538-2-5/8</b>	Cushion Clamp – 2-5/8"	EA	10
<b>538-3-1/8</b>	Cushion Clamp – 3-1/8"	EA	10
<b>538-3-5/8</b>	Cushion Clamp – 3-5/8"	EA	10
<b>538-4-1/8</b>	Cushion Clamp – 4-1/8"	EA	10

### Liquid Line Driers

High moisture and acid capacity. Maximum filtration capacity. Exceptional compatibility with new polyester oils. Compatible with all existing and new refrigerants and blends including 134a, 401A/B, 402A/B, 404A, 407A/B/C, 410A, 502, 507A. Spring loaded, molecular sieve and activated alumina. Solid copper sweat fittings. Powder paint exterior coating surpasses 500 hour ASTM salt spray test and resists corrosion. Eliminates concern of additive stripping.



### Suction Line Driers

The solid-core clean-up dryer was developed for use in a system suction line. The compact design incorporates a large outside diameter shell, which results in a shorter lay-in length, and a larger core, which provides a greater filtration area for maximum operating efficiency. The core material has controlled porosity which effectively removes and holds a maximum amount of contaminants with a minimum of pressure drop. It collects and holds inorganic acids and other harmful contaminants from a motor burnout. This binding process protects the core from acid decomposition. Access valves on both the inlet and outlet sides make it easy to measure pressure accurately. Occasionally, enough contaminant matter may collect in the filter core to cause a slight pressure drop. The access valves on the SLD make it easy to determine if a pressure drop exists and to measure the amount of the drop. The original DSLD, solid core, activated alumina suction line filter dryer. High acid capacity. Low pressure drop – exceptionally high flow rates. Designed for system clean-up. 500 hours salt spray protection. Shortest system cut-out lengths allow installation in tight areas. Two access valves simplify pressure drop measurement. Flare or solid copper sweat fittings.



CATALOG NO.	VIRGINIA KMP	CONNECTION	CUBIC INCH	UOM	ORDER MULTIPLE
DAD032	WLD-032 FLARE	1/4	3	EA	1
DAD032S	WLD-032 SWEAT	1/4	3	EA	1
DAD052	WLD-052 FLARE	1/4	5	EA	1
DAD052S	WLD-052 SWEAT	1/4	5	EA	1
DAD053S	WLD-053 SWEAT	3/8	5	EA	1
DAD082	WLD-082 FLARE	1/4	8	EA	1
DAD082S	WLD-082 SWEAT	1/4	8	EA	1
DAD083S	WLD-083 SWEAT	3/8	8	EA	1
DAD084S	WLD-084 SWEAT	1/2	8	EA	1
DAD163	WLD-163 FLARE	3/8	16	EA	1
DAD163S	WLD-163 SWEAT	3/8	16	EA	1
DAD164S	WLD-164 SWEAT	1/2	16	EA	1
DAD303	WLD-303 FLARE	3/8	30	EA	1
DAD303S	WLD-303 SWEAT	3/8	30	EA	1
DAD304S	WLD-304 SWEAT	1/2	30	EA	1
DAD305	WLD-305 FLARE	5/8	30	EA	1
DAD305S	WLD-305 SWEAT	5/8	30	EA	1

CATALOG NO.	VIRGINIA KMP	CONNECTION	CUBIC INCH	UOM	ORDER MULTIPLE
DSL13-5SVHH	AL-24-55C Sweat	5/8	13	EA	1
DSL13-6SVHH	AL-30-6SC Sweat	3/4	13	EA	1
DSL27-7SVHH	AL-30-7SC Sweat	7/8	27	EA	1
DSL27-9SVHH	AL-44-9SC Sweat	1-1/8	27	EA	1
DSL54-11SVHH	AL-75-11SC Sweat	1-3/8	54	EA	1
DSS-SLD306SV	VSD-6 & S Sweat	3/4	30	EA	1
DSS-SLD307SV	VSD-7 & S Sweat	7/8	30	EA	1

### Universal Spun Copper Driers

Manufactured with the latest generation molecular sieves compatible with more than 20 different types of refrigerants, including R-134A. They can be used in all hermetic and open refrigeration systems using CFC, HCFC and HFC gases and mixes such as commercial and domestic refrigerators, freezers and air conditioners ranging from 1/8 to 2.0 HP. Hermetically sealed with extended ends.

CATALOG NO.	OUTLET	INLET	DIAMETER	LENGTH GRAMS	DESSICANT R12	RECOMM. R22	TONNAGE QUANTITY	UOM	ORDER MULTIPLE
DX-3	1/4"	1/4"	3/4"	7-11/16"	10	1/3	1/2	EA	24
DX-4	Multiple	1/4"	1"	9"	18	3/4	1-1/2	EA	1
DXA-5	1/4"	1/4"	1"	9-1/4"	20	3/4	1-1/2	EA	1



**DRIERS, SIGHT GLASSES cont'd**

**Bi Flow Driers**

The "DBF" Series is designed specifically for heat pump or reverse cycle application. External check valves are not required since they are incorporated within the filter dryer shell. The core design filters out contaminant particles down to 25 microns. 100% copper sweat or nickel plated flare fittings. Desiccant core provides reliable and effective, removal of solid contaminants, acid and moisture. Provides three times the filtration as the standard bi-flow. Core is cushioned in fiber gaskets to protect core and to insure trouble-free performance. Powder paint exterior coating surpasses 500 hour ASTM salt spray test and resists corrosion.



**DBF163S**

CATALOG NO.	VIRGINIA KMP	CONNECTION	CUBIC INCH	UOM	ORDER MULTIPLE
<b>DBF083</b>	V2A-083 Flare	3/8	8	EA	1
<b>DBF083S</b>	V2A-083 Sweat	3/8	8	EA	1
<b>DBF084</b>	V2A-084 Flare	1/2	8	EA	1
<b>DBF084S</b>	V2A-084 Sweat	1/2	8	EA	1
<b>DBF163</b>	V2A-163 Flare	3/8	16	EA	1
<b>DBF163S</b>	V2A-163 Sweat	3/8	16	EA	1
<b>DBF164S</b>	V2A-164 Sweat	1/2	16	EA	1
<b>DBF165S</b>	V2A-165S Sweat	5/8	16	EA	1

**Sight Glasses**

Sight Glass and Moisture Indicator provides a quick visual diagnosis of refrigerant and moisture levels within a system. The sight glass indicates if the system has the proper refrigerant level, a restricted dryer or excessive pressure-drop. The moisture indicator recognizes moisture within the system. Provides early warning that a potential failure exists resulting in corrosion, chemical damage, restricted flow, or even compressor failure. Etch-resistant glass with a simple color comparison provides easy viewing and quick diagnostics. Flare models feature forged brass body and fittings for corrosion resistance. Sweat models feature copper fittings to permit solder installation without disassembly. Leak-proof design is compact and short in length to easily fit within a unit and provide accuracy in performance.



**DPSG-2**

CATALOG NO.	VIRGINIA KMP	DESCRIPTION	CONNECTION	UOM	ORDER MULTIPLE
<b>DPSG-2</b>	LDE-2	FLARE	1/4	EA	1
<b>DPSG-3</b>	LDE-3	FLARE	3/8	EA	1
<b>DPSG-4</b>	LDE-4	FLARE	1/2	EA	1
<b>DPSG-5</b>	LDE-5	FLARE	5/8	EA	1
<b>DPSG-2MF</b>	LDE-2-MF	MALE/FEMALE	1/4	EA	1
<b>DPSG-3MF</b>	LDE-3-MF	MALE/FEMALE	3/8	EA	1
<b>DPSG-4MF</b>	LDE-4-MF	MALE/FEMALE	1/2	EA	1
<b>DPSG-5MF</b>	LDE-5-MF	MALE/FEMALE	5/8	EA	1
<b>DPSG-2S</b>	LDE-2-S	SWEAT	1/4	EA	1
<b>DPSG-3S</b>	LDE-3-S	SWEAT	3/8	EA	1

**REFRIGERANT CHARGING**

**Insta-Charge**

Faster, safer and more economical method for charging LIQUID refrigerant through the low pressure side of an air conditioning or refrigeration system, without damaging the compressor. Insta-Charge's unique internal restrictor reduces liquid flow to a level below the capacity of the compressor. Converts liquid refrigerant to a saturated vapor for fast entry. Insta-Charge connects directly to the refrigerant can or cylinder valve. Adds liquid tracing dye faster. Eliminates heating of refrigerant cylinder. Made of light weight aluminum. Sold at a fraction of the cost of other fast charging devices.



**RC-1**

CATALOG NO.	DESCRIPTION	UOM	ORDER MULTIPLE
<b>RC-1</b>	Insta-Charge	EA	1



**LINE SETS**

**DiversiTech Line Sets**

DiversiTech Line Sets are individually packaged in sturdy corrugated cardboard, designed and tested for individual parcel shipment.

Line Sets are designed for air conditioning and refrigeration systems. The copper tube is refrigeration grade tubing to ASTM B280. The suction line is pre-insulated with Armaflex AP pipe insulation. This insulation is a black flexible elastomeric thermal insulation. The expanded closed-cell structure makes it an efficient insulation. It is manufactured without the use of CFC's, HFC's or HCFC's. AP Armaflex contains Microban® antimicrobial product protection for added defense against mold on the

insulation. DiversiTech Min-Split Line Sets are similar to Standard Line Sets but come with additional insulation on the liquid line and flared line ends. Copper tubing complies with ASTM B280 for Seamless Copper Tube for ACR.

AP Armaflex insulation meets ASTM C534, Type I – Tubular Grade 1, ASTM E84, NFPA 255, UL723, CAN/ULC S102, UL94 5V-5A, V-0 (E55798), NFPA 90A/90B, UL181, ASTM G21/C1338, ASTM G22, ASTM D1056 2B1, MIL-P-15280J form T, MIL-C-3133C grade SBE3, MEA 96-85-M, and City of LA RR7642.



**D40680250B3B6**

**STANDARD LINE SETS**

CATALOG NO.	LENGTH (FT)	INSULATION WALL	SUCTION LINE	LIQUID LINE	UOM	ORDER MULTIPLE
D61220250	25	1/2	3/4	3/8	EA	1
D61220350	35	1/2	3/4	3/8	EA	1
D61220500	50	1/2	3/4	3/8	EA	1
D61420250	25	1/2	7/8	3/8	EA	1
D61420350	35	1/2	7/8	3/8	EA	1
D61420500	50	1/2	7/8	3/8	EA	1
D61230250	25	3/4	3/4	3/8	EA	1
D61230350	35	3/4	3/4	3/8	EA	1
D61230500	50	3/4	3/4	3/8	EA	1
D61430250	25	3/4	7/8	3/8	EA	1
D61430350	35	3/4	7/8	3/8	EA	1
D61430500	50	3/4	7/8	3/8	EA	1
D61280250	25	3/8	3/4	3/8	EA	1
D61280350	35	3/8	3/4	3/8	EA	1
D61280500	50	3/8	3/4	3/8	EA	1
D61480250	25	3/8	7/8	3/8	EA	1
D61480350	35	3/8	7/8	3/8	EA	1
D61480500	50	3/8	7/8	3/8	EA	1
D61880250	25	3/8	1-1/8	3/8	EA	1
D61880350	35	3/8	1-1/8	3/8	EA	1
D61880500	50	3/8	1-1/8	3/8	EA	1
D61820250	25	1/2	1-1/8	3/8	EA	1
D61820350	35	1/2	1-1/8	3/8	EA	1
D61820500	50	1/2	1-1/8	3/8	EA	1

**MINI-SPLIT LINE SETS**

CATALOG NO.	LENGTH (FT)	INSULATION WALL	SUCTION LINE	LIQUID LINE	UOM	ORDER MULTIPLE
D40680250B3B6	25	3/8	3/8	1/4	EA	1
D40680350B3B6	35	3/8	3/8	1/4	EA	1
D40680500B3B6	50	3/8	3/8	1/4	EA	1
D40880250B3B6	25	3/8	1/2	1/4	EA	1
D40880350B3B6	35	3/8	1/2	1/4	EA	1
D40880500B3B6	50	3/8	1/2	1/4	EA	1
D41080250B3B6	25	3/8	5/8	1/4	EA	1
D41080350B3B6	35	3/8	5/8	1/4	EA	1
D41080500B3B6	50	3/8	5/8	1/4	EA	1
D61080250B3B6	25	3/8	5/8	3/8	EA	1
D61080350B3B6	35	3/8	5/8	3/8	EA	1
D61080500B3B6	50	3/8	5/8	3/8	EA	1
D40620250B3B6	25	1/2	3/8	1/4	EA	1
D40620350B3B6	25	1/2	3/8	1/4	EA	1
D40820250B3B6	25	1/2	1/2	1/4	EA	1
D40820350B3B6	35	1/2	1/2	1/4	EA	1
D40820500B3B6	50	1/2	1/2	1/4	EA	1
D40820250B3B6	25	1/2	5/8	1/4	EA	1
D40820350B3B6	35	1/2	5/8	1/4	EA	1
D40820500B3B6	50	1/2	5/8	1/4	EA	1
D61020250B3B6	25	1/2	5/8	3/8	EA	1
D61020350B3B6	35	1/2	5/8	3/8	EA	1
D61020500B3B6	50	1/2	5/8	3/8	EA	1

*If ordering by pallet, 15 line sets are packed per pallet.*

**REFRIGERANT LABELS**

**DiversiTech Refrigerant ID Labels**

These 3" x 4" self-adhesive vinyl labels use a high-tack acrylic adhesive and UV cured screen printing. Color coded to conform to refrigerant labeling convention. Each label indicates the type of refrigerant (eg. R-11), the chemical name (eg. Trichloromonofluoromethane) and the UN No. (eg. UN 1078). Avoid costly mistakes by properly identifying the type of refrigerant contained in recovery cylinders and air conditioning and refrigeration equipment.



**DiversiTech Refrigerant ID Labels (cont'd)**

CATALOG NO.	DESCRIPTION	UOM	ORDER MULTIPLE
<b>NON-FLAMMABLE GAS LABELS (4" x 4")</b>			
<b>04700</b>	Non Flammable Gas Labels, pack of 10	PK	1
<b>SYSTEM REFRIGERANT/OIL LABELS (3" x 4")</b>			
<b>04850</b>	Refrigerant Removed Labels, pack of 10	PK	1
<b>04852</b>	System Refrigerant/Oil Labels, pack of 10	PK	1
<b>SYSTEM LUBRICANT IDENTIFICATION LABELS (2" x 3")</b>			
<b>04870</b>	Polyol Ester Oil Labels, pack of 10	PK	1
<b>04871</b>	Mineral Oil Labels, pack of 10	PK	1
<b>04872</b>	Alkylbenzene Oil Labels, pack of 10	PK	1

CATALOG NO.	DESCRIPTION	UOM	ORDER MULTIPLE
<b>REFRIGERANT IDENTIFICATION LABELS (3" x 4")</b>			
<b>04010</b>	R-408A (FX10) Refrigerant ID Labels, pack of 10	PK	1
<b>04011</b>	R-11 Refrigerant ID Labels, pack of 10	PK	1
<b>04012</b>	R-12 Refrigerant ID Labels, pack of 10	PK	1
<b>04022</b>	R-22 Refrigerant ID Labels, pack of 10	PK	1
<b>04056</b>	R-409A (FX56) Refrigerant ID Labels, pack of 10	PK	1
<b>04099</b>	MO99 Refrigerant ID Labels, pack of 10	PK	1
<b>04123</b>	R-123 Refrigerant ID Labels, pack of 10	PK	1
<b>04134</b>	R-134a Refrigerant ID Labels, pack of 10	PK	1
<b>04401</b>	R-401A (MP39) Refrigerant ID Labels, pack of 10	PK	1
<b>04402</b>	R-402A (HP80) Refrigerant ID Labels, pack of 10	PK	1
<b>04404</b>	R-404A (HP62/FX70) Refrigerant ID Labels, pack of 10	PK	1
<b>04407</b>	R-407C (SUVA 9000/KLEA 66) Refrigerant ID Labels, pack of 10	PK	1
<b>04410</b>	R-410A (AZ20) Refrigerant ID Labels, pack of 10	PK	1
<b>04414</b>	R-414B Refrigerant ID Labels, pack of 10	PK	1
<b>04421</b>	R-421A Refrigerant ID Labels, pack of 10	PK	1
<b>04451</b>	R-401B (MP66) Refrigerant ID Labels, pack of 10	PK	1
<b>04500</b>	R-500 Refrigerant ID Labels, pack of 10	PK	1
<b>04507</b>	R-507 (AZ50) Refrigerant ID Labels, pack of 10	PK	1

**REFRIGERANT RECOVERY PRODUCTS**

**Refrigerant Recovery Cylinders**

DOT Classified for recovery, recycling, service and reclaim. Liquid and vapor valves ("Y" valve or separate valve configurations) are installed in all cylinders. Painted yellow/gray per ARI guidelines. Float switches have 3-pin Brad Harrison connectors.

CATALOG NO.	DESCRIPTION	DOT CLASS	3/4" NPT PLUG	FLOAT SWITCH	WATER CAP.	TARE WT.	UOM	ORDER MULTIPLE
<b>02033</b>	30 lb.	4BA400	YES	NO	26.2 lbs.	17 lbs.	EA	1
<b>02035</b>	30 lb.	4BA400	NO	YES	26.2 lbs.	17 lbs.	EA	1
<b>02053</b>	50 lb.	4BA400	YES	NO	47.7 lbs.	28 lbs.	EA	1
<b>02055</b>	50 lb.	4BA400	NO	YES	47.7 lbs.	28 lbs.	EA	1
<b>02100</b>	100 lb.	4BW400	NO	NO	123 lbs.	48 lbs.	EA	1
<b>02255</b>	250 lb.	4BW260	YES	NO	239 lbs.	85 lbs.	EA	1



Caution: Never overfill cylinders. Maximum refrigerant capacity is limited to 80% of the water capacity of the cylinder in lbs. (see table above). DOT requires cylinders to be retested every five years. Some recovery equipment uses weight scales to cut off refrigerant fill at 80% of capacity. Be sure cylinder tare weight is correct for this type of equipment.

**DOT Classification Example:** 4BA400: 400 psi working pressure; 800 psi test pressure (double the working pressure); 1,600 psi minimum burst pressure (double the test pressure). Pressure relief/safety valve is set to release at between 75-100% of the test pressure. For example, in the 4BA400 tanks which have a 800 psi test pressure, the relief valve opens at between 600 psi and 800 psi.

## Tubing Insulation

Highest quality tubing insulation by Armacell. AC Accoflex® tubing insulation is a flexible rubber product from the inventors of elastomeric foam insulation. It is designed exclusively for HVAC, with a tough surface and excellent resistance to ultraviolet damage, condensation and mold.



### 3/8" WALL

CATALOG NO.	DESCRIPTION	UOM	ORDER MULTIPLE
7-3838	3/8" ID x 3/8" Wall, pack of 600'	PK	1
7-3812	1/2" ID x 3/8" Wall, pack of 480'	PK	1
7-3858	5/8" ID x 3/8" Wall, pack of 390'	PK	1
7-3834	3/4" ID x 3/8" Wall, pack of 330'	PK	1
7-3878	7/8" ID x 3/8" Wall, pack of 270'	PK	1
7-381-18	1-1/8" ID x 3/8" Wall, pack of 210'	PK	1
7-381-38	1-3/8" ID x 3/8" Wall, pack of 180'	PK	1
7-381-58	1-5/8" ID x 3/8" Wall, pack of 120'	PK	1
7-382-18	2-1/8" ID x 3/8" Wall, pack of 96'	PK	1
7-382-58	2-5/8" ID x 3/8" Wall, pack of 72'	PK	1
7-383-18	3-1/8" ID x 3/8" Wall, pack of 54'	PK	1

### 1/2" WALL

CATALOG NO.	DESCRIPTION	UOM	ORDER MULTIPLE
7-1238	3/8" ID x 1/2" Wall, pack of 450'	PK	1
7-1212	1/2" ID x 1/2" Wall, pack of 396'	PK	1
7-1258	5/8" ID x 1/2" Wall, pack of 300'	PK	1
7-1234	3/4" ID x 1/2" Wall, pack of 240'	PK	1
7-1278	7/8" ID x 1/2" Wall, pack of 210'	PK	1
7-121-18	1-1/8" ID x 1/2" Wall, pack of 150'	PK	1
7-121-38	1-3/8" ID x 1/2" Wall, pack of 120'	PK	1
7-121-58	1-5/8" ID x 1/2" Wall, pack of 90'	PK	1
7-122-18	2-1/8" ID x 1/2" Wall, pack of 60'	PK	1
7-122-58	2-5/8" ID x 1/2" Wall, pack of 60'	PK	1
7-123-18	3-1/8" ID x 1/2" Wall, pack of 42'	PK	1

### 3/4" WALL

CATALOG NO.	DESCRIPTION	UOM	ORDER MULTIPLE
7-3438	3/8" ID x 3/4" Wall, pack of 240'	PK	1
7-3412	1/2" ID x 3/4" Wall, pack of 210'	PK	1
7-3458	5/8" ID x 3/4" Wall, pack of 144'	PK	1
7-3434	3/4" ID x 3/4" Wall, pack of 138'	PK	1
7-3478	7/8" ID x 3/4" Wall, pack of 120'	PK	1
7-341-18	1-1/8" ID x 3/4" Wall, pack of 90'	PK	1
7-341-38	1-3/8" ID x 3/4" Wall, pack of 72'	PK	1
7-341-58	1-5/8" ID x 3/4" Wall, pack of 60'	PK	1
7-342-18	2-1/8" ID x 3/4" Wall, pack of 54'	PK	1
7-342-58	2-5/8" ID x 3/4" Wall, pack of 48'	PK	1

### 1" WALL

CATALOG NO.	DESCRIPTION	UOM	ORDER MULTIPLE
7-1058	5/8" ID x 1" Wall, pack of 120'	PK	1
7-1078	7/8" ID x 1" Wall, pack of 90'	PK	1

# High Rise Pan™



The High Rise Pan™ is an innovative new plastic drain pan design which allows placement of an air handler 2-3/4" above the outside lip of the pan without the need for separate, cumbersome mounting blocks. The pan has a molded-in network of risers to give a 5" lift. The risers are positioned to accept a wide variety of air handler sizes. Each riser has a specially shaped area at each end to accommodate a 2" x 2" anti-vibration pad which allows for quiet operation at all times. Other features include heavy duty reinforcement throughout to give plenty of support as well as rolled edges for durability. One-piece plastic construction ensures no rust, leaks, or seams to split. Each High Rise Pan™ comes complete with a Condensate Cop™ float switch, six EVA™ anti-vibration pads, and one 3/4" PVC male adapter. Installation is straightforward and hassle-free.



- Nestable
- 5" Riser
- Heat/Cold resistance
- Eliminates a single line vendor
- Uses standard anti-vibration pad
- 80% thicker than the standard drain pan
- Water pushes to the side of the pan
- Heavy-duty reinforced ABS construction/flexible material
- Installation kit includes six EVA™ pads and Condensate Cop™ float switch

# DISTRIBUTOR SUPPORT



## LITERATURE

### Catalogs

CATALOG NO.	DESCRIPTION	STANDARD PACK
LIT-CAT-CD	HVAC Catalog on CD	10
LIT-CAT-HVAC	Issue 20 Catalog	10
LIT-CAT-NEW	New Products Catalog	10

### Tri-Folds

Each DiversiTech tri-fold brochure has a specific product focus. The tri-folds can be used as counter handouts, or mailed to a contractor. Brochure holders are also available. Most tri-folds are 8-1/2" high by 3-5/8" wide.



### Literature Holders

CATALOG NO.	DESCRIPTION	STANDARD PACK
MKT-POP-BROCH	Brochure Holder w/DiversiTech Logo Imprinted	1
MKT-POP-BROCH4	4-Pocket Brochure Holder	1
MKT-POP-EASEL	Acrylic Tri-Fold Brochure Holder	1

### Samples/Demos



CATALOG NO.	DESCRIPTION	STANDARD PACK
LIT-FLY-3D	Triple-D™ Brochure	25
LIT-FLY-3D-S	Triple-D™ Brochure (Spanish)	25
LIT-FLY-3PHASE	DTP-3 Brochure	25
LIT-FLY-AVPAD	Anti-vibration Pad Brochure	25
LIT-FLY-BPPOOL	The Black Pad® Brochure	25
LIT-FLY-CDLC	Condensate Drain Line Cleaners Brochure	25
LIT-FLY-CLAD	CladLite® Pad Brochure	25
LIT-FLY-CLRVUE	ClearVue™ Pump Brochure	25
LIT-FLY-COND	Condensate Monitoring Switches Brochure	25
LIT-FLY-CS1200	CS1200 A/C Shutoff Brochure	25
LIT-FLY-CVKUBE	ClearVueKube™ Pump Brochure	25
LIT-FLY-CVKUBE-S	ClearVueKube™ Pump Brochure (Spanish)	25
LIT-FLY-CVMINI	ClearVue™ Mini Pump Brochure	25
LIT-FLY-CVMINI-S	ClearVue™ Mini Pump Brochure (Spanish)	25
LIT-FLY-DISC	Fusible Disconnect Brochure	25
LIT-FLY-DST10	Hard Start Kit Brochure	25
LIT-FLY-DTP3	Three Phase Motor Protector Brochure	25
LIT-FLY-DTP3ES	Three Phase Motor Protector Brochure (Spanish)	25
LIT-FLY-ELITE	E Lite® Pad Brochure	25
LIT-FLY-FLOW	Flow Plus™ Brochure	25
LIT-FLY-FPIC	Flow Plus™ Inline Cleaner Brochure	25
LIT-FLY-GG	Drain Gun Brochure	25
LIT-FLY-HEAT	Heat Pump Pad™ Brochure	25
LIT-FLY-HEF	Hef-T-Pad Brochure	25
LIT-FLY-HPAD	Hurricane Pad Brochure	25
LIT-FLY-HRP	High Rise Pan™ Brochure	25
LIT-FLY-HSI	Universal Hot Surface Igniter Brochure	25
LIT-FLY-LS	LineSeal™ Refrigerant Sealant Brochure	25
LIT-FLY-MDP	Metal Drain Pan Brochure	25
LIT-FLY-MOTORS	Motor Brochure	25
LIT-FLY-MSPLIT	SpeediChannel™ Brochure	25
LIT-FLY-PF	Pro-Flush Brochure	25
LIT-FLY-PF-S	Pro-Flush Brochure (Spanish)	25
LIT-FLY-PUMP	Condensate Pump Brochure	25
LIT-FLY-SCAP	SwitchCap™ Dual Trifold Brochure	25
LIT-FLY-SPRAYER	Power Sprayer Brochure	25
LIT-FLY-SPRAYER-S	Power Sprayer Brochure (Spanish)	25
LIT-FLY-UC	UltraLite® Pad Brochure	25
LIT-FLY-UCSTRAP	UltraLite® Earthquake Pad Brochure	25
LIT-FLY-UV	Pure-Beam™ UV Light Brochure	25
LIT-FLY-WS	Wet Switch® Brochure	25

CATALOG NO.	DESCRIPTION	STANDARD PACK
6-HK2748-SAM	High Rise Pan – 27" x 48"	1
6-M3030-SAM	Metal Drain Pan – 30" x 30"	1
6-M3030L-SAM	Molded Drain Pan – 30" x 30" w/hole	1
MKT-POP-DUCTSAM	SpeediChannel Rep Sample Kit (Duct & Flat Elbow)	1
MKT-POP-WSDEMO	Wet Switch Demo Kit	1
MKT-SAM-ELEC	Sample Packet for Electrical	1
MKT-SAM-HSI	Sample Kit for TrueStart Hot Surface Igniters	1
PF-DEMO	Pro-Flush Demos	1
MKT-DEMO-SCAP	SwitchCap™ Dual Countertop Display	1

**Posters**

CATALOG NO.	DESCRIPTION	STANDARD PACK
<b>MKT-POSTER-CLRVUE</b>	ClearVue™ Pump Poster	1
<b>MKT-POSTER-MSPLIT</b>	SpeediChannel™ Parts Poster	1
<b>MKT-BANNER</b>	Diversitech Vinyl Banner 2' x 5'	1

**P.O.P. Merchandisers/  
Displays**

CATALOG NO.	DESCRIPTION	STANDARD PACK
<b>MKT-POP-CHEM</b>	DiversiTech/Specialty Chemical Display 26" base x 73" height	1
<b>MKT-POP-CLRGOND</b>	ClearVue™ Pump Display for Gondola	1
<b>MKT-POP-CLRKIT</b>	ClearVue™ Pump Distributor POP Kit	1
<b>MKT-POP-CLRSHELF</b>	ClearVue™ Pump Shelf Talker	1
<b>MKT-POP-CLRSTAND</b>	ClearVue™ Pump Banner Stand	1
<b>MKT-POP-CP22</b>	CP22 Pump Gondola Display	1
<b>MKT-POP-CVTUBE</b>	ClearVueTube Display	1
<b>MKT-POP-DEV16</b>	DEVCO Display Rack – PB16	1
<b>MKT-POP-DEVBACKS</b>	DEVCO Background Graphics – 24" x 32" Pegboard/Slatwall	Set of 2
<b>MKT-POP-DEVBACKSSLAT</b>	DEVCO Background Graphics for Slatwall	
<b>MKT-POP-DEVCOMBO</b>	DEVCO Display Rack – Combo	1
<b>MKT-POP-DEVELEC</b>	DEVCO Display Rack – Electrical	1
<b>MKT-POP-DEVEZC</b>	DEVCO Display Rack – EZC	1
<b>MKT-POP-DTBACKS</b>	DiversiTech Background Graphics – 24" x 32" Pegboard/Slatwall	Set of 2
<b>MKT-POP-DTBACKSSLAT</b>	Diversitech Background Graphics for Slatwall	1
<b>MKT-POP-DUCT</b>	SpeediChannel Merchandising Display	1
<b>MKT-POP-HSI</b>	Merchandiser Display for TrueStart Hot Surface Igniters	1
<b>MKT-POP-LS</b>	Merchandiser Display for LineSeal Refrigerant Sealant	1
<b>MKT-POP-PF</b>	Pro-Flush Display	1
<b>MKT-POP-SCAP</b>	SwitchCap™ Dual Floor Merchadiser	1
<b>MKT-POP-WS</b>	Wet Switch Counter Display	1
<b>MKT-POP-CDLC</b>	Condensate Drain Line Cleaner Display	1



**MKT-POP-CHEM**

**MKT-POP-DEV16**

**MKT-POP-DEVCOMBO**

**MKT-POP-DEVELEC**

**MKT-POP-DEVEZC**

**U.S. GENERAL TERMS AND CONDITIONS****General Policy**

**WE ARE COMMITTED TO DO WHAT IT TAKES TO DELIVER WORLD CLASS SERVICE AND PRODUCTS.**

All items not ordered in multiples of standard package quantities will automatically be increased to the next standard package quantity. All purchase orders submitted by our customers are assumed as accepting our general terms and conditions as stated herein, any conflicting terms stated on the purchase order cannot supersede our terms.

**Order Discrepancies:**

All order discrepancies must be reported to us within 5 working days from the date of delivery. Any discrepancies reported after this period cannot be honored.

**Terms:**

1% 15 days. Net 30 days. Late charges of 1-1/2% per month will be charged following the due date of the invoice. Prices subject to change without notice.

**Minimum Order:**

\$100.00 minimum order on all original orders. \$15.00 Broken Pallet Charge will be added for each pad size less than the standard pallet quantities.

**Freight Policy**

CONTINENTAL U.S.: All orders in excess of \$2,000 will ship prepaid. This policy applies to any combination of DiversiTech, Wagner, Specialty Chemical, and Devco products.

**Pick Up Allowance**

3% of net invoice, 24-hour notice requested. Order must qualify for prepaid freight to receive pick up allowance.

**Lost or Damaged Freight**

Although we take special care to insure the safe arrival of your merchandise, our responsibility for damages cease when the customer accepts the shipment. To protect your interest, we suggest that you thoroughly inspect all items before accepting delivery. If your order was damaged in shipment or contains a shortage, report the loss or damage AT ONCE to DiversiTech. Any claims for lost or damaged freight must be noted on the Bill of Lading at the time of delivery. If damage is present, you MUST hold the original carton and merchandise for credit by your Sales Representative – otherwise, no claim can be honored.

**Returns:**

No merchandise will be accepted for return without prior authorization. Call our Customer Service Department to request permission to return goods. Instructions on method of return will be given to you at that time. All returns are subject to a 25% restocking charge.

**Warranty Disclaimer**

DiversiTech has made a diligent effort to illustrate and describe the products in this catalog accurately; however, such illustrations and descriptions are for the sole purpose of identification, and do not express or imply a warranty that the products are merchantable or fit for a particular purpose, or that the products will necessarily conform to the illustrations or descriptions. DiversiTech assumes no liability for typographical or photographic errors.

DiversiTech reserves the right to make changes in design, material or finish in an effort to improve our products without special notification. If necessary, DiversiTech reserves the right to replace any product shown in catalog with another comparable product without special notification.

**DiversiTech's ULTRALITE®, CLADLITE®, and E LITE® Limited Lifetime Warranty**

To the original owner of the ULTRALITE®, CLADLITE®, or E LITE® equipment base, DiversiTech warrants the base to be free of defects in materials and workmanship for the life of the equipment under which it is installed so long as the installing homeowner lives there. All defective merchandise must be returned to the factory, transportation prepaid, and if the same is found to be defective, it will be repaired or replaced free of charge, F.O.B. factory. This warranty does not cover replacement labor cost, or any cost claim incident to the defect, replacement, or reinstallation, nor field repair expenses. This warranty gives you specific legal rights and you may also have other rights which vary from state to state. Some states do not allow the exclusion or limitation of incidental or consequential damages, so the above limitation of exclusion may not apply to you.

**Exclusions and Limitations**

DiversiTech's ULTRALITE®, CLADLITE®, and E LITE® equipment pads are designed and manufactured to be used as bases for light, ground supported equipment such as air conditioning condensers, swimming pool filters and heat pumps. Use of ULTRALITE®, CLADLITE®, and E LITE® pads for purposes other than those listed above or improper installation of ULTRALITE®, CLADLITE®, and E LITE® pads may result in pad failure. DiversiTech Corporation disclaims any liability due to such misuse or improper installation. If you have questions concerning the proper installation or use of DiversiTech's ULTRALITE®, CLADLITE®, and E LITE® equipment pads, you should contact our Customer Service Department at (800)995-2222.



**DOMESTIC CREDIT APPLICATION**

<b>COMPANY NAME:</b> _____	For internal use only <b>CUSTOMER #:</b> _____
----------------------------	---

SHIP TO \_\_\_\_\_ PHONE # \_\_\_\_\_

ADDRESS \_\_\_\_\_ FAX # \_\_\_\_\_

CITY/STATE \_\_\_\_\_ ZIP CODE \_\_\_\_\_

E-MAIL \_\_\_\_\_

BILL TO \_\_\_\_\_

NAME \_\_\_\_\_ PHONE # \_\_\_\_\_

ADDRESS \_\_\_\_\_ FAX # \_\_\_\_\_

CITY/STATE \_\_\_\_\_ ZIP CODE \_\_\_\_\_

E-MAIL \_\_\_\_\_

**PRINCIPALS** \_\_\_\_\_**BUYING GROUP MEMBER** \_\_\_\_\_**BUSINESS STRUCTURE\*:** CORPORATION \_\_\_\_\_ PARTNERSHIP \_\_\_\_\_ INDIVIDUAL \_\_\_\_\_ \*Please check one**CREDIT LIMIT REQUESTED** \_\_\_\_\_ **DUNS #** \_\_\_\_\_**ESTIMATED SALES VOLUME** \_\_\_\_\_ **FEDERAL TAX ID #** \_\_\_\_\_**YEARS IN BUSINESS** \_\_\_\_\_**BANK REFERENCE****NAME** \_\_\_\_\_ **PHONE #** \_\_\_\_\_**ADDRESS** \_\_\_\_\_ **OFFICER** \_\_\_\_\_**CITY/STATE** \_\_\_\_\_ **ZIP CODE** \_\_\_\_\_**ACCOUNT #** \_\_\_\_\_**THREE MAJOR TRADE REFERENCES (U.S. based are preferred)****NAME** \_\_\_\_\_ **TITLE** \_\_\_\_\_**CONTACT** \_\_\_\_\_ **PHONE #** \_\_\_\_\_**CITY/STATE/ZIP** \_\_\_\_\_ **FAX #** \_\_\_\_\_**E-MAIL** \_\_\_\_\_ **ACCOUNT NUMBER** \_\_\_\_\_**NAME** \_\_\_\_\_ **TITLE** \_\_\_\_\_**CONTACT** \_\_\_\_\_ **PHONE #** \_\_\_\_\_**CITY/STATE/ZIP** \_\_\_\_\_ **FAX #** \_\_\_\_\_**E-MAIL** \_\_\_\_\_ **ACCOUNT NUMBER** \_\_\_\_\_**NAME** \_\_\_\_\_ **TITLE** \_\_\_\_\_**CONTACT** \_\_\_\_\_ **PHONE #** \_\_\_\_\_**CITY/STATE/ZIP** \_\_\_\_\_ **FAX #** \_\_\_\_\_**E-MAIL** \_\_\_\_\_ **ACCOUNT NUMBER** \_\_\_\_\_

## CATEGORY INDEX

007 Control Checker.....	171	Armored Connector.....	115	Clipboards.....	164
2-in-1 Copper Tube Cleaning Brush.....	162	Armored Plug.....	115	Clipboards and Form Holders.....	164
3/4™ Rubber Elbow.....	190	Aviation Snips.....	174	Clips.....	113
3-36® Multi-Purpose Lubricant.....	78	Batteries.....	75	Cloth Duct Tape.....	36
45 Degree Ell.....	43	Bearings.....	133	CO2 Cylinders.....	160
45 Degree Ell C x C.....	237	Bi Flow Driers.....	246	Coil Cleaners.....	222-224
45 Degree Flat Bend.....	204	Big Helper™ - PVC Pipe Cutter.....	180	Coil Cleaning Aerosols.....	224
45 Degree Street Ell Ftg. x C.....	237	Bi-Metal Reciprocating Saw Blades.....	173	Coil Guard™.....	223
45 Elbows.....	186	Black Jack Roof Cement.....	83	Combination CO & Smoke Alarms.....	41
45 Ell (Slip x Slip).....	188	Black Nylon Cable Tie Assortment.....	106	Combination Couplings.....	105
4-Piece Hook and Pick Set.....	171	Black Nylon Ties with Mounting Hole.....	157	Combination Packs.....	95
6180 Series Terminal Blocks.....	117	Black Nylon Wire Ties.....	157, 206	Combination Screwdrivers.....	174
6190 Series Terminal Blocks.....	117	Black Steel Welded Nipples.....	43	Combo Head Sheet Metal Screws.....	110
6-in-1 Flip Driver.....	173	Blade (Auto) Fuses.....	113, 145	Compartmented Storage Boxes.....	151
90 Degree Ell.....	43	Blind Rivet Tools.....	108	Compression Connector.....	242
90 Degree Ell C x C.....	236	Blower on Relays.....	40	Compression Elbow.....	242
90 Degree Flat Bend.....	204	Blue Label Permanent Air Filters.....	35	Compression Nut.....	242
90 Degree Inside Elbow.....	204	Booster Fans.....	31	Compression Sleeve.....	242
90 Degree Long Radius Bend.....	204	Box Cover Units.....	145	Compression Sprayers.....	227
90 Degree Long Turn Ell C x C.....	237	Boxes, Rings, and Covers.....	103-104	Compression Tee.....	242
90 Degree Long Turn Street Ell Ftg. x C.....	236	Brass Adapters.....	240	Compression Union.....	242
90 Degree Outside Elbow.....	204	Brass Fittings.....	242	Compressor Heaters.....	147
90 Degree Street Ell.....	44	Brushes.....	161	Compressor Lead Kit.....	95
90 Degree Street Ell Ftg. x C.....	237	Bubble-N-Trouble™ Leak Detector.....	228	Compressor Repair Kit.....	151
90 Elbow (Hub x Hub).....	186	Bug Spray.....	84	Compressor TOTE.....	170
90 Ell (FIPT x FIPT).....	187	Bulbs.....	104	Concentric Vents.....	41
90 Ell (Slip x FIPT).....	187	Bushing.....	44	Condensate Cop™.....	67
90 Ell (Slip x Slip).....	187	Bushing (MIPT x FIPT).....	182	Condensate Drain Line Switches.....	67
90 Ell Reducing (Slip x FIPT).....	187	Bushings and Locknuts.....	107	Condensate Drain Pans.....	70
90 Ell Reducing (Slip x Slip).....	187	Butt Connector Assortment Kit.....	97	Condensate Drain Pans, Fittings, Adapters.....	69
90 Street Ell (MIPT x Slip).....	188	Butt Connectors – Insulated.....	96	Condensate Pumps.....	66
90 Street Ell (SPIG x Slip).....	188	BX and Greenfield Connectors.....	105	Condenser Equipment Mounting.....	27
A/C Brackets.....	26	BX Set Screw Connectors.....	136	Condenser Fan Motors.....	132
A/C Condensate Drain Pan Fittings.....	70	Cable Connectors.....	105	Condenser/Heat Exchanger Brushes.....	163
A/C Secondary Condensate Drain Pans.....	69	Cable Markers.....	119	Conduit Fittings.....	107
Abrasive Cloth.....	74	Cable Staples.....	136	Conduit Nipples.....	107
Abrasive Cloths.....	74	Cable Tie Assortment Pack.....	156	Conduit, Fittings, Cable.....	135
Access Fittings.....	240	Cable Tie Holder.....	33, 156	Contact Cleaners.....	75
Accessories.....	223-224	Cable Tie Mounts.....	106	Contactors Accessories.....	142
Acid Eliminator™.....	233	Cable Tie Mounts.....	106	Contactors.....	141
Acid Test Kits.....	231	Cable Ties and Accessories.....	106	Cool Weld™ Heat Barrier Spray.....	223
Acrylic Latex Painter's Caulk.....	82	Calipers.....	164	Cop Cap™ Locking Valve Cover.....	240
Adapter (Insert x Slip).....	190	Canopy Strap.....	175	Copper Coupling with Dimple Stop.....	239
Additives.....	233	Cap.....	44, 205, 238, 243	Copper Coupling with No Stop.....	239
Adjustable Delay on Break Time.....	145	Cap (FIPT).....	189	Copper Fittings.....	236-239
Adjustable Delay on Make Timer.....	145	Capacitors.....	137-138	Copper Saddle Valve.....	241
Adjustable Flat Bend.....	203	Carabiners.....	175	Copper Tube Fitting Brushes.....	162
Aerosols.....	74	Carbon Monoxide & Smoke Alarms.....	41	Core Removal Tool.....	241
Air Filters.....	35	Carbon Steel Curved Handle Scratch Brush.....	163	Core Storer.....	241
Air Handler Base.....	26	Carton Sealing Tape.....	75	Cork Insulation Tape.....	71
Air Handler Blocks.....	26	Carton Tape Dispenser.....	75	Cotter Pins.....	111
All Purpose Cleaning Pads.....	74	Catalogs.....	252	Coupling.....	44
All Purpose Enamel.....	79	Caulk Gun.....	82	Coupling (Slip x Slip).....	188
All Purpose Lubricant.....	78	Caulking Sealant.....	82	Coupling (Socket) w/ Rolled Tube Stop C x C.....	237
All Purpose Sprayers.....	227	CBC II Contact Cleaner.....	74	Couplings (Hub x Hub).....	186
All Weather PVC Cement.....	184	Channellock® Products.....	164	CP-22 Low Profile Pumps.....	66
All Weather Test Leads.....	176	Channels.....	203	CP-22 Pumps.....	66
Allen Duracast Fold Ups.....	161	Chip Brushes.....	161	CPVC-CTS Pipe and Fittings.....	182
Allen Wrenches.....	161	Chlor-Free® Degreaser.....	76	CPVC-CTS Pipe by FlowGuard® Gold™.....	182
All-Purpose Clear Cement.....	184	Circuit Breakers.....	149	Cross (Slip x Slip x Slip x Slip).....	188
Aluminum Armored MC Cable.....	135	Citrus Degreaser.....	76	CS1200 AC Shutoff Switch.....	67
Aluminum Dryer Vent Hoods, Kits, and Fittings.....	32	CladLite® Pads.....	22	Cushion Clamps.....	244
Aluminum Foil Tape.....	36	Clean Out Tee.....	190	Cushioned Pillow Blocks.....	133
Aluminum Solderless Lugs.....	119	Clear Vinyl Tubing.....	71	Cylinder Valves.....	160
Anchor Kit.....	83	ClearVueKübe™ Pump.....	66	Definite Purpose Contactors.....	141
Anchors.....	101-102	ClearVue™ Mini.....	66	Degreasers.....	76
Angle Iron Brackets.....	27	ClearVue™ Pump.....	66	Deluxe Hi-Tension Hacksaw.....	173
Anti-Vibration Pads.....	28	ClearVue™ Traps.....	68	Detecto™ Iridescent Leak Detector.....	228
		ClearVue™ Tube & Traps.....	68		

Devco Crimpers.....	108	Electrical Tapes.....	150	Fully Insulated Flag Female Slip-Ons.....	95
Device Rings.....	103	Electrical Toggle Switches.....	148	Fully Insulated Male Slip-Ons.....	94
Dial-a-Mix Sprayer.....	227	Electrolytic Copper Solderless Lugs.....	119	Fully Insulated Receptacles.....	95
Digital 1 PC Air Flow Meter with CFM Display.....	168	Electronic Degreaser.....	76	Furnace Mounting Blocks.....	26
Digital Fractional Calipers.....	164	Electronic Utility Scales.....	173	Fuse Adapters.....	145
Digital Jumbo Display Service Thermometer.....	179	EMT (Thinwall) Fittings.....	136	Fuse Holders.....	117
Digital Multimeter with Bright Screen Display.....	170	Enviropad™.....	25	Fuse Pullers.....	145
Digital Single Phase Line Voltage Monitor.....	146	Epoxy Coated Gas Connectors.....	42	Fuseblocks.....	145
Digital Temperature and Humidity Pen.....	178	Equipment Support Systems.....	203	Fuses.....	144
Digital Therm. with 2 K-Type Probes and Case.....	177	EVA Anti-Vibration Pad.....	28	Fusible Links.....	152
Digital Three Phase Line Voltage Monitor.....	146	Expando Adjustable Condenser Tube Cleaner.....	171	Gallo Gun™, Charles.....	68
Digital UL Listed Multimeter.....	170	Extension Cords.....	165	Garden Hose.....	227
Direct Drive Furnace Blower Motors.....	132	Extension Rings.....	103	Garden Hose Adapters.....	182
Direct Replacement Igniters.....	40	Extension Rods for Condenser Tube Brushes.....	163	Gas Ball Valve.....	43
Disconnect Switches.....	135	E-Z™ Ratchet II Tube and Pipe Cutter.....	179	Gas Pressure Test Kit.....	169
Disconnects - Metal Case.....	135	E-Z™ Ratchet Tubing Cutter.....	179	Gas Valves and Connectors.....	42
Disconnects - Non Metallic Case.....	135	Fan Centers.....	143	Gauges.....	160,168
DiversiGum™ Sealing Compound.....	82	Fast Cure Epoxy.....	81	General Purpose Pumps.....	66
DiversiTech Gas Connectors.....	42	Fast Orange® Hand Cleaner.....	76	General Purpose Relays.....	143
DiversiTech Refrigerant ID Labels.....	248	Felt Tip Markers.....	79	General Purpose Spray Paint.....	79
DiversiWhips.....	134	Female Adapter (Barb x FIPT).....	182	General Purpose Switching Relays.....	143
DiversiWhips for the Swimming Pool Industry.....	134	Female Adapter (Slip x FIPT).....	189	General Tools.....	108
DiversiWhips Pallet Packs.....	134	Female Adapter C x F.....	236	Geocel Caulking Sealant.....	82
DiversiWhips with Extended Length Wires.....	134	Female Adapter Elbow (Barb x FIPT).....	183	Glass Cleaner.....	74
Dormont 20 Series.....	42	Female Adapter Fig. x F.....	236	Glass Cloth, Economy Electrical Tapes.....	150
Dormont 20 Series with Valve.....	43	Female Adapter Reducing (Slip x FIPT).....	189	Gloves.....	80
Dormont 30 Series.....	42	Fender Washers.....	109	Glycol Inhibitors.....	233
Double Zipper Rigger's Bag.....	179	Fin Tools.....	165-166	Glycol Test Strips.....	231
Drain Dawg™ and Drain Kat™ Fittings.....	69	Fin Whisk.....	163	Glycols.....	225-226
Drain Gun and Cartridges.....	68	Finished Hex Nuts.....	108	Gorilla Tube™ Clear Vinyl Tubing.....	71
Drain Line, Tubing.....	71	Firestop Products for Class A Buildings.....	82	Grease Fittings.....	112
Drain Pan Disinfectant, Sealant.....	224	First Aid Kits.....	80	Grip-Cut™.....	74
Drain Pans.....	69-70	Fitting Reducer Coupling Fig. x C.....	238	Grommets - Vinyl.....	151
DrainDawg™.....	68	Fittings.....	203	Ground Adapter.....	115
DrainKat™.....	68	Flag Disconnects.....	94, 98	Ground Fitting Clamp.....	119
Driers, Sight Glasses.....	245	Flag Female Compressor Terminal Kit.....	95	Grounding Rubber Handle Plug.....	115
Drive Fasteners.....	101	Flag Female Compressor Terminals.....	95	Hand Cleaners.....	76
Drop-In Expansion Anchor Setting Tool.....	101	Flag Rings.....	98	Hanging Strap.....	175
Drop-In Expansion Anchors.....	101	Flame Sensor.....	41	Hanging Wire.....	34
Dryer Duct, Vent Hose, Hose Clamps.....	32	Flare Tee.....	243	Hard Start Kits.....	140
Dryer Hose Clamps.....	33	Flare Union.....	244	Heat Pump Pad™.....	25
Dryer Receptacle.....	150	Flare x FIP Union.....	244	Heat Pump Risers.....	26
Dryer Vent Hose.....	32	Flare x Flare Swivel Union.....	244	Heat Resistant Cloth.....	180
D'Scale™ Acid Scale Remover.....	231	Flare x MIP Elbow.....	242	Heat Shrink Tubing.....	117
Dual Element Fuses.....	113, 144	Flare x MIP Reducing Elbow.....	243	Heat Shrink Tubing - 50% Polyolefin.....	151
Duct Cleaning Brush.....	162	Flare x MIP Union.....	243	Heat Shrink Tubing Assortments.....	118
Duct End.....	205	Flashlights and Lanterns By Rayovac.....	166	Heating Products.....	226
Duct Fans.....	31	Flashlights By Mag-Lite®.....	167	Heavy Duty Bracket.....	27
Duct Strap.....	34	Flat Wall Escutcheon.....	206	Heavy Duty Cable Ties.....	33, 156
Duct Strap, Ties, Clamps.....	33, 156	Flat Washers.....	109	Heavy Duty Degreaser.....	76
Duct Tape.....	36	Flex Duct Tape.....	36	Heavy Duty Degreaser II.....	76
Duct-Fresh Gel.....	228	Flex Joint.....	205	Heavy Duty Nylon Cable Ties.....	106
Duct-Fresh Spray.....	228	Flow Plus™ Condensate Pan Treatment.....	229	Heavy Duty PVC Cement.....	184
Dust Masks.....	80	Flow Plus™ Inline Cleaner.....	68	Heavy Duty Ratchet Strap.....	175
DWV Bend Fittings.....	186	Flowmeters.....	160	Heavy Duty Silicone Mold Release.....	78
DWV Bushings.....	186	Flow-Plus Inline Cleaner.....	68	Heavy Duty Work Gloves.....	80
DWV Vent Tee.....	186	Flow-Plus™ Condensate Pan Treatment.....	229	Hef-T-Block™.....	27
E Lite® Pads.....	21	Flue Caps.....	31	Hef-T-Brackets™.....	27
Eco-Coil™ Environ. Friendly Coil Cleaner.....	222	Flush Bushing.....	238	Hef-T-Foot™.....	203
Economy Electrical Tape.....	150	Flushing Products.....	225	Hef-T-Frame™.....	203
Egg Crate Louvers - Air Return.....	31	Foam Insulation Tape.....	71	Hef-T-Pad™.....	24
Elbow (Barb x Barb).....	183	Foam Sealant - One Component.....	81	Hex Head Cap Screws.....	109
Elbow (FIPT x FIPT).....	183	Foam Sealant - Two Component.....	81	HF™ Contact Cleaner.....	75
Electrical Duplex Receptacles.....	148	Foam-Plus™ Aerosol Foaming Coil Cleaner.....	224	High Heat Spray Paint.....	79
Electrical Outlet Boxes, Extentions and Covers.....	148	Foil Scrim Kraft Tape.....	36	High Performance Refrigerant Leak Detector.....	169
Electrical Staples.....	107	Fresh-Coil.....	223	High Rise Pans™.....	70
Electrical Supplies.....	148-150, 165	Fully Insulated Dead End Connectors.....	96	High Temp Red Silicone Sealant.....	82
		Fully Insulated Female Slip-On.....	94	High Temperature Assortment.....	99

## CATEGORY INDEX cont'd

High Temperature Butt Connectors .....	99	Little Helper™ - All Purpose Cutter .....	179	Non-Insulated Plugs .....	95
High Temperature Condenser Fan Motors .....	132	Louvered Dryer Vent Hood .....	33	Non-Insulated Rings .....	98
High Temperature Female Slip-Ons .....	99	Low Profile Disconnects - Metal Case .....	135	Non-Insulated Spades .....	97
High Temperature Flag Female Slip-Ons .....	99	Low Profile Pumps .....	66	Non-Insulated Spring Spades .....	97
High Temperature Male Slip-Ons .....	99	Low Voltage Screwdriver Tester .....	176	Non-Metallic Sheathed Cable .....	136
High Temperature Rings .....	99	Lubricants .....	77	NT™ Precision Cleaner .....	76
High Temperature Solderless Terminals .....	99	LuxPro Thermostats .....	153	Nut Setter - Power .....	172
High Temperature Spades .....	99	Machine Screw Hex Nuts .....	108	Nut Setters .....	172
High Temperature Wire .....	155	MAC-The Ultimate in Line Piercing Valves .....	241	Nuts and Bolts .....	108
Hobby and Cutting Knives .....	168	Mag Charger System .....	167	Nylon Cable Clamps .....	111
Homeline Circuit Breakers, Square D .....	149	Mag-Lite® C and D Cell Flashlights .....	167	Nylon Cable Ties .....	106
Horizontal Refrigerator/Freezer Analog Therm. ....	178	Mag-Lite® Replacement Bulbs .....	167	Nylon Cable Ties with Mounting Hole .....	106
Horizontal Vent Term Kits .....	41	Magna-Lite .....	167	Nylon Fittings .....	182
Hose Clamps .....	111, 190	Magnetic Hex Chucks .....	108	Nylon Insert Lock Nuts .....	108
Hose Mender (Barb x Barb) .....	183	Magnetic Nut Setters - Bulk .....	172	Nylon Nut and Washer .....	111
Hoses .....	160	Magnetic Retrieving Tool .....	172	Nylon Rods .....	111
Hoses, Sprayers .....	227	Male Adapter (Barb x MIPT) .....	182	Oatey® Products .....	184
Hot Surface Igniters .....	40	Male Adapter (MIPT x Slip) .....	189	Odor Neutralizers .....	228
Hot Water Hose .....	227	Male Adapter C x M .....	236	Offset Snips .....	174
Hurricane Pad™ .....	23	Male Adapter Elbow (Barb x MIPT) .....	183	Oils .....	230-232
Hurricane Pad™ Attachment Bracket .....	23	Male Adapter Fig. x M .....	236	One Time Fuses .....	144
HVAC Airflow Instruments .....	168	Male Adapter Reducing (MIPT x Slip) .....	189	Outdoor Extension Cord .....	165
HVAC Tools .....	174	Malleable Black Iron Pipe Fittings .....	43	Outside Tube Cleaning Brushes .....	162
HVACR Refrigerant Leak Detector with Pump .....	169	Manifold Gauge .....	168	P.O.P. Merchandisers / Displays .....	253
Hydroguage Manometer .....	169	Manometers, Pressure .....	169	Paints and Primers .....	79
Ice Machine Products .....	228	Manual Reset Fire Stat .....	152	Pan Treatments/Disinfectants .....	229
Icemaker Kit .....	191	Map-Pro and Propane Gas .....	180	Pan-Kote Heavy Duty Drain Pan Patch .....	224
Igniters .....	40	Markers .....	79	Pan-Patch™ .....	224
Incandescent Light Bulbs .....	104	Masonry Bit .....	83	Parts Cleaning Brush .....	162
Indicator Lights .....	118	Masonry Screw .....	83	Periscope Connection Kit .....	33
Industrial Enamel .....	79	Measuring Tapes, Staples and Staple Guns .....	169	Permanent Air Filters .....	35
Industrial Towels .....	77	Mechanical Pickup .....	172	Pigtails .....	119
In-Line Fuse Holder .....	145	Mechanical Screw Starter .....	170	Pilot Burners .....	40
Insta-Charge .....	246	Medium Split Lock Washers .....	109	Pipe Hanging Strap .....	111
Insta-Tap Refrigerant Recovery Tool .....	241	Merchandising .....	252, 253	Pipe Mounted Switches .....	67
Insulated Butt Connectors .....	96	Metal Bat Handle Toggle Switches .....	116	Pistol Grips & Water Nozzle .....	227
Insulated Female Slip-Ons .....	94	Metal Drain Pan .....	70	Plastic Anchor Kits .....	102
Insulated Flange Spades .....	97	Metal Drive Anchors .....	101	Plastic DWV J-Hooks .....	190
Insulated Hooks .....	96	Metal Guard Trouble Lights .....	165	Plastic Hanger Strap .....	34
Insulated Male Slip-Ons .....	94	Metal Parts Boxes .....	112	Plastic Thermostat Guards .....	153
Insulated Plugs .....	95	Metallic Ducts .....	33	Plastic Wall Plates .....	149
Insulated Rings .....	98	Meters, Detectors, Alarms .....	169	Plastic Wide Mouth Dryer .....	32
Insulated Spades .....	97	Mini AC AMP Clamp Meter .....	170	Plated Steel Utility Covers .....	103
Insulated Spring Spades .....	97	Mini Mag-Lite® .....	167	Plenum Thermostat Wire .....	154
Iso-Cube Economy Anti-Vibration Pad .....	28	Mini Split Condensate Drain .....	71	Plier Flaring Tool .....	179
J-B Weld .....	81	Mini Split Line Sets .....	247	Plug .....	44, 244
Jumbo Display Indoor/Outdoor Thermometer .....	178	Mini-Split Drain Adapters .....	70	Plug (MIPT) .....	189
Kimberly-Clark Waterless Hand .....	76	Mini-Split Pump .....	66	Plug (Slip) .....	188
Kimtex® Towels .....	77	Miscellaneous Tools .....	170	Plug Fuses - Fast Acting .....	144
Knock'er Loose® Penetrating Solvent .....	77	Monitors .....	146, 171	Pocket 4-in-1 Mini Screwdriver .....	173
Knockout Seals and Hole Plug .....	107	Motor Bolts .....	109	Pocket HVAC Gen Purpose IR Thermometer .....	177
Kut-All Plastic Tube and Hose Cutter .....	179	Motor Brackets .....	133	Polyethylene Tubing .....	190
Lashing Strap .....	175	Motor Mount - Flex Bracket .....	133	Polypropylene Parts Boxes .....	112
Latex Gloves .....	80	Motor Run Capacitors - 370VAC .....	138	POP Merchandisers .....	253
Leak Detectors .....	228	Motor Run Capacitors - 440VAC .....	139	Porcelain Outlet Box Lampholders .....	116
Leak Test Gauge .....	176	Motor Shaft Key Assortments .....	111	Porcelain Wire Connectors .....	119, 156
Leather Work Gloves .....	80	Motor Start Capacitors .....	140	Portable Hand Torch .....	180
LED Screwdriver Continuity Tester .....	176	Motors .....	132	Posters .....	253
Light Bulbs .....	104, 165	Mounting Brackets, Blocks .....	26	Potential Relays .....	143
Line Piercing Valves and Tools .....	241	Multi Color Test Leads .....	176	Power Blocks .....	165
Line Sets .....	247	Multi-Head Fin-Tool .....	165	Power Cords and Work Lights .....	110
LineSeal™ Refrigerant Line Sealant .....	233	Multiple Horsepower Condenser Fan Motors .....	133	Power Measuring Tapes .....	169
Liquid Line Driers .....	245	Multiple Horsepower Motors .....	133	Power Sprayer .....	227
Liquid Tite Connectors .....	136	Nitrile Gloves .....	80	Power Supply Cords (Pigtails) .....	150
Liquid Tite Flexible Conduit .....	135	Nitrogen Cylinders .....	160	Power Supply Replacement Cords .....	116
Liquid-tite connectors .....	105	Non-Insulated Female Slip-Ons .....	94	Precision Screwdriver Set .....	112
Literature .....	252	Non-Insulated Flag Female Slip .....	94	Pro-Air Duct Sealant™ UL 181 .....	82
Literature Holders .....	252	Non-Insulated Male Slip-Ons .....	94	Pro-Air Indust Grade Adhesive .....	83

Pro-Blue™.....	222	Reducer Coupling.....	205	Shoe Covers.....	80
Pro-Brown™.....	222	Reducer Coupling w/Stop C x C.....	238	Shop Towels.....	77
Pro-Bubble™ Leak Detector.....	224	Reducing Bushing (MIPT X FIPT).....	188	Short Forged Flare Nut.....	243
Pro-Flush™.....	225	Reducing Coupling.....	44	Short Nut.....	243
Pro-Flush™ Accessories.....	225	Reducing Tee.....	44	Side Flange Mount Pillow Blocks.....	133
Pro-Green™.....	222	Reducing Tee C x C x C.....	239	Sight Glasses.....	246
Pro-Kleen™.....	223	Reducing Washers.....	107	Silicone Sealant.....	82
Pro-Lube-ALK™ Alkylbenzene.....	231	Refractometers.....	172	Single Piece Liquid Tite Fittings.....	136
Pro-Lube-POE™ Polyolester.....	231	Refrigerant Charging.....	246	SJTO Service Cord.....	114
Pro-Lube™ Mineral Oil.....	230	Refrigerant Labels.....	248	Slip-On Solderless Terminals.....	94
Pro-Lube-VAC™ Vacuum Pump Oil.....	232	Refrigerant Recovery Cylinders.....	248	Slotted Round Head Machine Screws.....	110
Pro-Prime™ Clear PVC Primer.....	185	Refrigerant Recovery Products.....	248	Smokeys.....	31
Pro-Prime™ PVC Primer (Purple).....	185	Refrigeration Oils.....	230-231	Snips, Notchers, Crimpers, Seamers.....	174
Pro-Red Plus™.....	223	Refrigerator Coil Brush.....	161	Soffit Fitting.....	203
ProTek BG™ Boiler Grade.....	226	Refrigerator/Freezer Analog Thermometer.....	178	Solitaire AAA Single Cell Flashlights.....	167
ProTek EG™.....	225	Refrigerator/Oven Thermometer.....	178	SP-400™ Corrosion Inhibitor.....	78
ProTek PG™ Aluminum Safe.....	226	Regulators.....	160	Spade Terminals.....	97-99
ProTek™ Closed Loop Heat Transfer Fluid.....	225	Rehvac Nitrogen Purging Equipment.....	160	Spark Electrode.....	41
ProTek™ PG 100.....	225	Rehvac Refillable Gas Cylinder.....	160	Special Purpose Solderless Terminals.....	95
ProTek™ PG Plus.....	225	Relays.....	143	Specialty Fasteners.....	111
Pro-Thaw™ Liquid Dryer for Refrigerants.....	233	Replacement Compressor Leads.....	151	Specialty Fittings.....	112
Pro-Tite™.....	232	Replacement Element Kits.....	152	Specialty Tools.....	112
Pro-Treat® 151.....	229	Retrieving Tool/Mini-Lights.....	172	SpeediChannel™.....	203
Pro-Treat® 152.....	229	Rheem Motor Bracket.....	133	SpeediChannel™ Accessories.....	206
Pro-Treat® 161.....	230	Right Angle Plug.....	115	SpeediChannel™ Fitting Kit.....	206
Pro-Treat® 200.....	230	Rigid Conduit Bodies.....	105	SpeediChannel™ Line Set Cover System.....	203
Pro-Treat® 217.....	230	Romex Connectors - Metallic.....	136	Spill Kill™ Catalytic Soot Remover.....	226
Pro-Treat® 350.....	229	Roof Flashing.....	31	Spill Kill™ Liquid - Fuel Spill Deodorant Spray.....	226
Pro-Treat® Pan Strips.....	229	Roof Inlets.....	206	Spill Kill™ Powder - Fuel Spill Deod. and Absorbent.....	226
Pro-Weld™ PVC Cement.....	185	Roof Louver.....	31	Split Bolt Connectors.....	119
Pro-Weld™ PVC Cement (Heavy Body).....	185	Rope.....	175	Square D Electrical Disconnects.....	135
Pro-Weld™ PVC Cement (Regular Body).....	185	Rough Service Light Bulbs.....	165	Standard Line Sets.....	247
Pro-Weld™ PVC Cement (Universal).....	185	Round Extension Cords.....	110	Standard Solderless Terminals.....	96
Pro-Yellow™.....	223	Rubber / Cork Anti-Vibration Pad.....	28	Standard Test Leads.....	176
P-Traps.....	239	Rubber Anti-Vibration Pad.....	28	Standard Wire Connectors.....	118
Pull-A-Spout Oiler.....	78	Rubber Connector.....	115	Staples.....	136
Pump Parts & Accessories.....	66	Rubber Tie Down Strap.....	175	Sta-Plex™ Premium Red Grease.....	78
Pumps.....	66	Safety Overflow Switch (SOS).....	67	Steel 1900 Boxes.....	103
Pure-Beam™ Ultraviolet Light.....	32	Safety Plates.....	104	Steel 1900 Covers.....	104
Purple Primer for PVC Pipe and Fittings.....	184	Safety Supplies, Devices.....	80	Steel Octagon Box.....	103
PVC Cement - Clear.....	184	Saf-N-Kleen™ Aerosol Solvent Coil Cleaner.....	224	Steel Thermostat Guards.....	153
PVC Condensate Pipe.....	186	Samples/Demos.....	252, 253	Steel Utility Boxes.....	103
PVC Condensate Pipe - White.....	186	Sani C-N-D™ Coil and Drain Pan Disinfectant.....	224	Stick-E-Tape.....	36
PVC DWV Fittings.....	186	Satchel Style Case.....	112	Sting Less Wasp & Hornet Killer.....	84
PVC Gray Cement for High Eff. Furnaces.....	184	Saws and Saw Blades.....	173	Storage Containers.....	112
PVC Primer - Clear.....	184	Scales.....	173	Stove Bolts.....	109
PVC Primer and Cement.....	185	Scotch 35 Vinyl Electrical Tape.....	150	Stranded Copper THHN Wire.....	154
PVC Ratchet Cutter.....	180	Scotch 3M Super 33+ Electrical.....	150	Stranded Copper Wire on Spool.....	155
PVC Schedule 40 Pressure Fittings.....	187	Scotch 3M Super 88 Electrical.....	150	Stranded Copper Wire on Spool, 100 Feet.....	154
QD® Contact Cleaner.....	75	Scotch® Electrical Tapes.....	150	Stranded Copper Wire, 194 Degree F.....	154
QQ200TR A/C Disconnect.....	135	Screwdrivers, Driver Sets.....	173	Stranded High Temperature Wire.....	114
Quick-Tap.....	241	Screwloose® Industrial Penetrating Oil.....	77	Strapping Hanger Iron.....	33
Quick-Tap-2.....	241	Screws.....	83, 84, 110	Straps.....	107
Radiant Leak Finder™.....	224	Sealant, Epoxy, Glue.....	81	Straps, Truck Rope.....	175
Radiator Vent Keys.....	112	Sealing Compounds, Adhesive.....	81	Styrene Parts Boxes.....	112
Rain-R-Shine Blue Cement.....	184	Self Tapping Water Valve.....	191	Suction Line Driers.....	245
Ratchet Strap.....	175	Self-Drilling Gypsum Wallboard Anchors.....	101	Super Glue.....	81
Rayovac Industrial Flashlights and Lanterns.....	166	Self-Drilling Screw Repair Kit.....	110	SuperComb.....	166
Rayovac Industrial Max Alkaline Batteries.....	75	Self-Drilling Screws.....	110	Super-Kool™ Ice Machine Cleaner.....	228
Rayovac Industrial Swivel Lights.....	166	Semi-Rigid Aluminum Duct.....	32	Supports.....	190
Rayovac Lantern Batteries.....	75	Sequencers.....	152	Sure Burn™ Fuel Oil Treatment.....	226
Rayovac LED Flashlights.....	166	Set Screws.....	111	Sure-Stick Heavy Duty Adhesive.....	74, 83
Rayovac Roughneck Flashlights.....	166	Sheet Metal Gauge.....	168	Sweat-Free Pipe Insulation Spray.....	74
Reach-It.....	172	Sheet Metal Screw Assortment Kit.....	83	Switch Covers.....	149
Receptacles.....	116	Sheet Metal Screw Assortments.....	110	Switch/Plug Combo.....	149
Red Label Permanent Air Filters.....	35	Sheet Metal Screws.....	83	SwitchCap™ Dual.....	137
Reducer Bushing (SPIG X FIPT).....	189	Sheet Metal Screws Drill Point.....	84	SwitchCap™ Dual Multiple Value Capacitor.....	137
Reducer Bushing (SPIG x Slip).....	189	Sheet Metal Screws Taper Point.....	84		

## CATEGORY INDEX cont'd

Swivel Head Deburring Tool.....	180	Tri-Fold Brochures.....	252	Wood Handle Dope Brush.....	162
System Cleaners.....	231	Triple Outlets.....	116	Workhorse® Manufactured Rags.....	77
T-50 Series Staples and Staple Guns.....	169	Triple-D™ Universal Coil Cleaner.....	222	WypAll Plus.....	77
Tab Adapters - Male Tabs.....	96	Trouble Lights.....	110	WypAll ShopPro X80 Towels.....	77
Tab Adapters - Piggy Back Slip-Ons.....	96	Truck Rope.....	175	Zinc Plated DC Steel Romex Connectors.....	105
Tab Adapters - Quick Disconnect with Screw.....	96	TrueStart® Ignition Accessory.....	40	Zinc-It® Instant Cold Galvanize.....	78
Tab Adapters - Single Fem Dbl Male Tabs.....	96	Tube Working Tools.....	179		
Tandem Grounding Rubber Handle.....	115	Tubing Insulation.....	249		
Tap Connectors.....	96	Tubing, Clamps, and Kits.....	190		
Tapes.....	36, 71, 113	Type "S" Non-Tamper Fuses.....	144		
Tattle-Tale Control Monitor.....	171	Type 2 Wall Brackets.....	27		
Tee.....	44	Type 3 Wall Brackets.....	27		
Tee (Barb x Barb x Barb).....	183	UL Listed Foil Tape.....	36		
Tee (Slip x FIPT x Slip).....	187	Ultra Lite 3-36® Lubricant.....	78		
Tee (Slip x Slip x Slip).....	187	UltraLite® Earthquake Pads.....	21		
Tee C x C x C.....	239	Ultralite® Lightweight Equipment Pads.....	20		
Teflon Tape.....	71, 113	UltraLite® Pads.....	20		
Telescopic Inspection Mirror.....	171	UltraLite® Wedge Pads.....	21		
Telescoping Mini-Light and Magnetic Pickup.....	172	UltraViolet Light.....	32		
Teri® Towels.....	77	Union.....	44		
Terminal Block Jumpers.....	117	Union C x Brass.....	238		
Terminal Kits.....	100	Union Coupling.....	205		
Terminals, Connectors.....	151	Universal Alarm.....	67		
Terry Towels.....	77	Universal Carbide Igniters.....	40		
Test Cord (Female).....	176	Universal Spun Copper Driers.....	245		
Test Kits, Strips, and Prevent.....	231	Upright Snips.....	174		
Test Leads.....	113, 176	Utility Covers.....	103		
Testers.....	113, 176	Utility Fuse Outlets.....	117		
Testers, Leads, Clips, Fuses.....	113	Utility Plates.....	103		
TFFN Stranded Hook-Up Wire.....	114	Utility Scales.....	173		
The Black Pad®.....	24	U-Type Strap.....	239		
The Hurricane Pad™.....	23	Vacuum Pump Oil.....	232		
The Hurricane Pad™ Bracket.....	23	Valve Action Marker.....	79		
The Hurricane Pad™ MD.....	23	Valve Action Paint Marker.....	79		
The Hurricane T-Class Pad™.....	23	Vent Termination Kits.....	41		
The Quad™ 14-Piece Saw/Drive.....	168	Ventilation Products.....	31		
Thermal Controls.....	152	Versa Cap® Flue and Hot Stack.....	31		
Thermometers.....	177-179	Vinyl Grommet Assortment Packs.....	117		
Thermometers/Probes.....	177	Vinyl Grommets.....	117		
Thermoplastic Handle Plug.....	115	Wagner Adhesive Sealant.....	81		
Thermostat Guards.....	153	Wall Escutcheon.....	206		
Thermostat Wire.....	114, 154	Wall Penetration.....	204		
Thermostats.....	153	Wasp, Hornet, and Yellow Jacket Killers.....	84		
THHN Stranded Hook-Up Wire.....	114	Waterless Hand Wipes.....	76		
Thinwall E.M.T. Connectors.....	105	Waterproof Box with Lever Switch Cover.....	104		
Thread Sealant with Teflon.....	81	Waterproof Butt Connectors.....	98		
Thread Sealants.....	232	Waterproof Covers.....	104		
Three Phase Disconnects.....	135	Waterproof Rings.....	98		
Three Pole Definite Purpose Contactors.....	141	Waterproof Solderless Terminal.....	98		
Time Delay Fuses.....	144	Waterproof Spades.....	98		
Time Delay Plug Fuses.....	144	WD-40®.....	78		
Time Delays.....	145	Weatherproof Boxes.....	104		
Tin Handle Acid Brushes.....	161	Welder's Brush.....	161		
Tinner Snips.....	174	Welding Torches, Supplies.....	180		
T-Joint.....	205	Wet Switch Flood Detector.....	67		
Toggle Bolts.....	108	Whips.....	134		
Toggle Switch and Receptacle Combo Device.....	116	White Lithium Grease.....	78		
Toggle Switch Cover.....	150	White Nylon Ties with Mounting Hole.....	157		
Toggle Switch Neon Pilot Light Combo Device.....	116	White Nylon Wire Ties.....	157		
Toggle Switches.....	116, 150	Winged Wire Connectors.....	118		
Tongue and Groove Pliers.....	164	Wire.....	114, 154, 157		
Tool Bags.....	179	Wire and Cable Clamps - Nylon.....	157		
Torches.....	180	Wire Connectors.....	155		
Torque Plus - Hard Start Kits.....	140	Wire for Mini-Split Installation.....	154		
Transformers.....	142	Wire Tie Mounts.....	157		
Transformers - Class 2.....	142	Wire/Cable Ties, Mounts, Clamps.....	156-157, 206		
Transparent Plastic Boxes with Terminal Asst.....	151	Wiring Devices.....	115		
Traps (Slip x Slip).....	187	Wolverine® Universal Hot Surface Igniter.....	40		

**PART NUMBER INDEX**

01714	81	20-3135-18	43	230-INJ465	206	3060-2	22	37800H	138
01724	81	20-3135-24	43	230-LFB3	204	3060-3	22	37800R	138
02033	248	20-3135-36	43	230-LFB4	204	3143-2	22	378-440	140
02035	248	20-3135-48	43	230-LFB6	204	3143-3	22	3842-2	22
02053	248	216-259	140	230-MB14W	27	315-20	74, 83	3842-3	22
02055	248	216-259220	140	230-MB17W	27	32-2	22	3865-3	22
02100	248	216-259330	140	230-MB36W	27	32-3	22	3870-3	22
02255	248	23010	80	230-MBCW	27	3232-2	22	3GJ0330	138
04010	248	230-14-4	154	230-SF3	203	3232-3	22	3GJ0515	138
04011	248	230-14-4S	154	230-SF4	203	3237-2	22	3GJ0520	138
04012	248	230-14-7	154	230-TC34	205	3237-3	22	3GJ0525	138
04022	248	230-16-2	154	230-TC46	205	324-388	140	3GJ0530	138
04056	248	230-18-4	154	230-TJ4	205	325-12	74	3GJ0535	138
04123	248	230-AFB3	203	230-TJ6	205	3345-3	22	3GJ0540	138
04134	248	230-AFB4	203	230-WC3	204	340-408	140	3GJ0545	138
04401	248	230-B2L	27	230-WC4	204	3434-2	22	3GJ0555	138
04402	248	230-B2M	27	230-WC6	204	3434-3	22	3GJ1015	138
04404	248	230-B3L	27	230-WR3	206	3465-3	22	3GJ1025	138
04407	248	230-B3M	27	230-WR4	206	357-20	224	3GJ1060	138
04410	248	230-B4L	27	230-WR6	206	358-20	224	3GJ1520	138
04414	248	230-BHD	27	230-WS2	204	36-2	22	3GJ7530	138
04421	248	230-BP14W	27	233-292	140	362-16	74	3GJ7535	138
04451	248	230-BP17W	27	233-292220	140	36-3	22	3GJ7545	138
04500	248	230-CP3	205	2424-2	22	3636-2	22	3GJ7555	138
04507	248	230-CP4	205	2424-3	22	3636-3	22	3GR0325	138
04700	248	230-CP6	205	2430-2	22	3640-2	22	3GR0330	138
04850	248	230-D3	203	2430-3	22	3640-3	22	3GR0335	138
04852	248	230-D4	203	2436-2	22	3648-2	22	3GR0340	138
04870	248	230-D6	203	2436-3	22	3648-3	22	3GR0425	138
04871	248	230-DC3	205	2442-2	22	3650-3	22	3GR0435	138
04872	248	230-DC4	205	2448-2	22	3654-2	22	3GR0515	138
1000-1200	140	230-DC6	205	2448-3	22	3660-3	22	3GR0520	138
10012	81	230-DCLIP	206	2454-2	22	3678-3	22	3GR0525	138
1002	227	230-DCLIP-10	206	2460-3	22	37020H	138	3GR0530	138
10180	81	230-DE3	205	25001	175	37030H	138	3GR0535	138
10600	81	230-DE4	205	2601	227	37040H	138	3GR0540	138
108-130	140	230-DE6	205	2602	227	37050H	138	3GR0545	138
108-130220	140	230-DL16	71	2603	227	37050HB	138	3GR0550	138
108-130330	140	230-DL16-20	71	26-2	22	37050R	138	3GR0555	138
124-156	140	230-DLF16	70	2626-2	22	37060H	138	3GR0560	138
124-156220	140	230-DLF18	70	2626-3	22	37075H	138	3GR0570	138
124-156330	140	230-DLF20	70	2636-2	22	37075HB	138	3GR0580	138
14145	31	230-DLF25	70	2660-2	22	37075R	138	3GR1035	138
14175	31	230-DLF32	70	2660-3	22	37100H	138	3GR1080	138
14250	31	230-DLFY	70	270-324	140	37100HB	138	3GR7530	138
14340	31	230-DPML	70	270-324220	140	37100R	138	3GR7540	138
14460	31	230-DPMM	70	270-324330	140	37125H	138	3GR7555	138
145-175	140	230-DPPL	70	2838-2	22	37125R	138	3GR7560	138
145-175220	140	230-DPPM	70	2838-3	22	37150H	138	3GR7580	138
145-175330	140	230-DSCREW	206	30-2	22	37150R	138	3WF-01	230
161-193	140	230-EB3	204	3030-2	22	37175H	138	3WF-05	230
161-193220	140	230-EB4	204	3030-3	22	37175R	138	400-480	140
161-193330	140	230-EB6	204	30306	164	37200H	138	4042-3	22
1636-2	22	230-EIN3	204	30309	164	37200R	138	4054-3	22
1636-3	22	230-EIN4	204	30310	164	37250H	138	4062-3	22
16491	82	230-EIN6	204	30-3131-24	42	37250R	138	4147-2	22
16500	180	230-FB3	204	30-3131-36	42	37300H	138	4147-3	22
16510	180	230-FB4	204	30-3131-48	42	37300R	138	4183-3	22
16520	180	230-FB453	204	30-3132-12	42	37350H	138	4200AX	99, 100
18001	82	230-FB454	204	30-3132-18	42	37350R	138	4204	99
18002	82	230-FB456	204	30-3132-24	42	37400H	138	4204CX	99
18003	82	230-FB6	204	30-3132-30	42	37400R	138	4205CX	99
189-227	140	230-FJ3	205	30-3132-36	42	37450H	138	4206	99
189-227220	140	230-FJ4	205	30-3132-48	42	37450R	138	4206CX	99
189-227330	140	230-FR3	206	30-3132-60	42	37500H	138	4213	99
200-240	140	230-FR4	206	30-3132-72	42	37500R	138	4213CX	99
20-3132-18	42	230-FR6	206	3036-2	22	37550R	138	4214	99
20-3132-24	42	230-IK3	206	3036-3	22	37600H	138	4214CX	99
20-3132-36	42	230-IK4	206	3040-2	22	37600R	138	4215	99
20-3132-48	42	230-INJ462	206	3040-3	22	37700H	138	4215CX	99

**PART NUMBER INDEX** cont'd

4217CX	99	45600H	139	4JR7560	139	525-PT1	180	5-401025	187
4219	99	45600R	139	4JR7570	139	525-TORCH	180	5-401030	187
4220	99	45700H	139	4JR7580	139	5262	104	5-402007	187
4220CX	99	45700R	139	4WF-01	230	5263	104	540-2110C	75
4221	99	45800H	139	4WF-05	230	5264	104	540-2114	80
4221CX	99	45800R	139	5002	108	5265	104	540-2144	80
4224	99	460-552	140	5022	112	5266	104	540-2200	80
4224CX	99	4700-12	182	50302	36	5-300020	185	540-25G	169
4224NX	99	4700-34	182	50304	36	5-300030	185	540-25R	169
4226	99	4701-12	182	50306	36	5-300050	185	540-278BM0024	173
4226CX	99	4701-34	182	5031	113	5-300060	185	540-278HX0002	173
4231	99	4703-12	182	5033	113	530-30752	184	5-403007	187
4236CX	99	4703-34	182	5035	113	530-30753	184	5-404	185
4252	99	4704-12	182	5036	113	530-30755	184	540-400	172
4252CX	99	4704-34	182	5041	113	530-30756	184	5-405	185
4253	99	4706-12	182	5042	113	530-30757	184	540-500	172
4253CX	99	4706-34	182	5045	113	530-30818	184	540-506	169
4254CX	99	4707-12	182	5046	113	530-30821	184	540-508	169
4272CX	99	47072-12	182	5053-3	22	530-30834	184	540-509	169
4293	119	47072-34	182	5056-3	22	530-30850	184	540-572	227
4293CX	119	4707-34	182	5-05790	77	530-30863	184	540-573	227
4294	119	4711-12	182	5058-3	22	530-30876	184	5-406005	187
4294CX	119	4711-34	182	5070-3	22	530-30884	184	5-406007	187
4296	119	4718-12	182	5-10	184	530-30885	184	540-601	172
4296CX	119	4766-3	22	5-100020	185	530-30890	184	5-406010	187
43-53220	140	4848-2	22	5-100030	185	530-30891	184	5-406015	187
43-53330	140	4848-3	22	510-3400	190	530-30893	184	5-406020	187
436-20	84	4JJ0525	139	510-3400-10	190	530-31132	184	5-406030	187
45020H	139	4JJ0530	139	510-437338	185	530-31133	184	5-406101	187
45030H	139	4JJ0535	139	510-438338	185	5-32	184	5-406130	187
45040H	139	4JJ0540	139	5107	108	5-321020	185	5-406131	187
45050H	139	4JJ0545	139	510-D102251	185	5-321030	185	540-648	140
45050HU	137	4JJ0555	139	510-D102338	185	5-33570	77	540-6510L	174
45060H	139	4JJ0560	139	510-D304020	185	5-34790	77	540-6510R	174
45075H	139	4JJ1055	139	510-D304030	185	535-BB1	133	540-6716B	174
45075HU	137	4JJ7535	139	510-D309020	185	535-BB2	133	540-6716L	174
45100H	139	4JJ7540	139	510-D309030	185	535-BB3	133	540-6716R	174
45100HU	137	4JJ7545	139	510-D323020	185	535-BB4	133	540-6716S	174
45125H	139	4JR0440	139	510-D323030	185	535-BB5	133	540-6900L	174
45125HU	137	4JR0520	139	510-D441020	185	535-BB6	133	540-6900R	174
45150H	139	4JR0525	139	510-D441030	185	5380AX	111	5-407	185
45150HU	137	4JR0525U	137	5-1115	179	5381	111	5-407005	187
45150R	139	4JR0530	139	5-11830	31	538-1/2	244	5-407007	187
45175H	139	4JR0530U	137	5-11840	31	538-1/4	244	5-407015	187
45175R	139	4JR0535	139	5-11853	31	538-1-1/8	244	5-407020	187
45200H	139	4JR0535U	137	5-11866	31	538-1-3/8	244	5-407025	187
45200HU	137	4JR0540	139	5-11879	31	538-1-5/8	244	5-407030	187
45200R	139	4JR0540U	137	5-12	184	5382	111	5-407074	187
45250H	139	4JR0545	139	5-14	184	538-2-1/8	244	5-407101	187
45250HU	137	4JR0545U	137	515-J2000	190	538-2-5/8	244	5-407130	187
45250R	139	4JR0550	139	515-J3000	190	5383	111	5-407131	187
45300H	139	4JR0550U	137	5200	110	538-3/4	244	540-799	79
45300HU	137	4JR0555	139	5-2001	185	538-3/8	244	5-408	187
45300R	139	4JR0555U	137	5-2002	185	538-3-1/8	244	540-800	79
45350H	139	4JR0560	139	5-2005	185	538-3-5/8	244	5-408007	187
45350HU	137	4JR0560U	137	5201	110	5384	111	540-805	79
45350R	139	4JR0570	139	5223	116	538-4-1/8	244	540-806	79
45400H	139	4JR0580	139	5223B	116	5385	111	540-807	79
45400HU	137	4JR1055	139	5224	116	538-5/8	244	540-808	79
45400R	139	4JR1060	139	5225	110	5386	111	540-811B	79
45450H	139	4JR1080	139	5230	110	5387	111	5-409	187
45450HU	137	4JR7525	139	5231	104	538-7/8	244	5-409005	188
45450R	139	4JR7530	139	5232	104	5-401	185	5-409007	188
45500H	139	4JR7535	139	5240	116	5-401005	187	5-409010	188
45500HU	137	4JR7540	139	5242	116	540-1005L	80	5-409012	188
45500R	139	4JR7540U	137	5246	113	5-401007	187	5-409015	188
4550-3	22	4JR7545	139	5250	104	5-401010	187	5-409020	188
45550H	139	4JR7545U	137	5252-3	22	5-401012	187	540-AK100	83
45550R	139	4JR7550	139	5255	113	5-401015	187	540-BH1L	80
4558-3	22	4JR7555	139	525-PT1	180	5-401020	187	540-BH1M	80



540-CARABINER.....	175	5-435010.....	189	585-TG5.....	153	6020.....	110	61028.....	232
540-DB6.....	83	5-435012.....	189	585-TG6.....	153	60201.....	97	6108.....	109
540-DISP.....	75	5-435020.....	189	585-TG7.....	153	60202.....	98	6109.....	109
540-FCTMC5.....	174	5-435030.....	189	585-TG8.....	153	60204.....	98	6113.....	111
540-FCTMN1.....	174	5-435074.....	189	585-TG9.....	153	60205.....	98	6115.....	111
540-FCTMS1.....	174	5-435101.....	189	590-708.....	140	60205CX.....	98	6-1200.....	31
540-FCTMS2.....	174	5-435102.....	189	5-91054.....	76	60206.....	98	61202.....	98
540-GUN.....	227	5-435131.....	189	5-HW5850.....	227	60209.....	97	61204.....	98
540-HU1L.....	80	5-436005.....	189	5-IG5850.....	227	6021.....	110	61205.....	98
540-HU1M.....	80	5-436007.....	189	5-MSH1/4MC.....	172	60210.....	96	61205CX.....	98
540-LG1M.....	80	5-436010.....	189	5-MSH5/16MC.....	172	60210CX.....	96	61206.....	98
540-P127D.....	174	5-436020.....	189	5-SCR101.....	84	60210LX.....	96	61207.....	98
540-P127S.....	174	5-436030.....	189	5-SCR101-12DP.....	84	60213.....	94	61208.....	98
540-R8CCRF.....	173	5-436074.....	189	5-SCR101-12DPBULK.....	84	60213CX.....	94	61209.....	98
540-RB125W.....	173	5-436101.....	189	5-SCR101-2.....	84	60214.....	94	61211.....	98
540-RB414M.....	173	5-436102.....	189	5-SCR101-2BULK.....	84	60215.....	98	61212.....	98
540-RB418M.....	173	5-436131.....	189	5-SCR101-2DP.....	84	60215CX.....	98	61213.....	98
540-RB424M.....	173	5-437101.....	189	5-SCR101-2DPBULK.....	84	60216.....	98	61214.....	97
540-RB610HDM.....	173	5-437130.....	189	5-SCR101BULK.....	84	60219.....	94	61215.....	97
540-RB614HDM.....	173	5-437131.....	189	5-SCR101DP.....	84	60219LX.....	94	61218.....	97
540-RB618HDM.....	173	5-437210.....	189	5-SCR101DPBULK.....	84	60220.....	94	61219.....	94
540-RB624HDM.....	173	5-437251.....	189	5-SCR102DP.....	84	60220LX.....	94	61220.....	94
540-RB636DW.....	173	5-437339.....	189	5-SCR102DPBULK.....	84	60226.....	97	61221CX.....	94
540-RB636W.....	173	5-438101.....	189	5-SCR103-4.....	84	60228.....	97	61221LX.....	94
540-RB656WS.....	173	5-438130.....	189	5-SCR103-4BULK.....	84	60230CX.....	96	61222.....	94
540-RB810HDM.....	173	5-438131.....	189	5-SCR103-4DP.....	84	60234.....	96	61222CX.....	94
540-RB814HDM.....	173	5-439131.....	188	5-SCR103-4DPBULK.....	84	60235.....	94	61223LX.....	94
540-RB956W.....	173	5-448005.....	189	5-SCR61-2DP.....	84	60238.....	97	61224.....	94
540-T50M.....	169	5-448007.....	189	5-SCR61-2DPBULK.....	84	60240.....	97	61230.....	96
540-T50MOC.....	169	5-448010.....	189	5-SCR63-8.....	84	60245.....	98	61230CX.....	96
5-41.....	174	5-449005.....	188	5-SCR63-8BULK.....	84	60247.....	98	61233.....	95
5-410.....	187	5-449007.....	188	5-SCR71-2.....	84	60249.....	96	61233LX.....	95
5-410005.....	188	5-449010.....	188	5-SCR71-2BULK.....	84	60251.....	94	61234LX.....	94
5-410007.....	188	5-449030.....	188	5-SCR81.....	84	60251CX.....	94	61235LX.....	94
5-410010.....	188	5-450007.....	189	5-SCR81-12.....	84	60252CX.....	98	61236.....	97
5-41041.....	77	5-450010.....	189	5-SCR81-12-100.....	84	60253.....	98	61237.....	97
5-41043.....	77	5-450015.....	189	5-SCR81-12BULK.....	84	60253LX.....	98	61239.....	97
5-411.....	187	5-450020.....	189	5-SCR81-12DP.....	84	60254.....	97	6-12-4.....	134
5-412.....	187	5-450030.....	189	5-SCR81-12DPBULK.....	84	60254CX.....	97	61245.....	98
541-300.....	177	545-420.....	164	5-SCR81-12W.....	84	60254LX.....	97	6-12-4NM.....	134
5-414.....	187	545-422.....	164	5-SCR81-12WTBUL.....	84	60255.....	97	6-12-4NM4SWP.....	134
5-41411.....	77	545-424.....	164	5-SCR81-2.....	84	60255LX.....	97	6-12-4NMP.....	134
5-41455.....	77	545-426.....	164	5-SCR81-25M.....	84	60256.....	97	6-12-4NMR.....	134
5-416.....	185	545-430.....	164	5-SCR81-2BULK.....	84	60256CX.....	97	6-12-4NMSWP.....	134
5-417.....	185	545-440.....	164	5-SCR81-2DP.....	84	60258NX.....	98	6-12-4P.....	134
5-417005.....	188	545-442.....	164	5-SCR81-2DPBULK.....	84	60259HX.....	95	6-12-4R.....	134
5-417007.....	188	545-460.....	164	5-SCR81BULK.....	84	60263BCX.....	106	61252.....	98
5-417010.....	188	5-474007.....	190	5-SCR81DP.....	84	60263BLX.....	106	61252NX.....	98
5-417012.....	188	548-001.....	179	5-SCR81DPBULK.....	84	60263CX.....	106	61254.....	98
5-417020.....	188	548-002.....	179	5-SCR82.....	84	60264BCX.....	106	61255.....	97
5-417025.....	188	548-003.....	180	5-SCR82-100.....	84	60264BLX.....	106	61255LX.....	97
5-417030.....	188	548-004.....	180	5-SCR82BULK.....	84	60264CX.....	106	61256.....	97
5-418.....	185	548-005.....	180	5-SCR82DP.....	84	60265BLX.....	106	61256LX.....	97
5-420007.....	188	548-006.....	180	5-SCR82DPBULK.....	84	60265LX.....	106	6-12-6.....	134
542-00966.....	162	548-007.....	180	5-SCR82W.....	84	60265NX.....	106	61265BCX.....	106
542-00968.....	162	548-008.....	180	5-SCR83-4.....	84	60272LX.....	98	61265LX.....	106
542-10007.....	162	548-009.....	180	5-SCR83-4BULK.....	84	60274.....	97	6-12-6NM.....	134
542-25015.....	162	548-010.....	180	5-SCR83-4DP.....	84	60285.....	95	6-12-6NM4SWP.....	134
5-42272.....	76	5-500.....	80	5-SCR83-4DPBULK.....	84	6030.....	110	6-12-6NMP.....	134
542-76220.....	162	5-520.....	190	5-SCR-AK.....	83	60331B.....	114	6-12-6NMR.....	134
5-429005.....	188	5557-3.....	22	5-SCRMS.....	83	60331BE.....	114	6-12-6NMSWP.....	134
5-429007.....	188	5-61.....	174	6000.....	111	60331GY.....	114	6-12-6NMSWP.....	134
5-429010.....	188	56-72.....	140	6001.....	111	60331P.....	114	6-12-6P.....	134
5-429012.....	188	56-72220.....	140	6002.....	111	60331R.....	114	6-12-6R.....	134
5-429015.....	188	585-F336.....	153	6003.....	111	60331W.....	114	61274.....	97
5-429020.....	188	585-TG.....	153	6004.....	111	6040.....	110	61275CX.....	97
5-429025.....	188	585-TG1.....	153	6005.....	111	6067-3.....	22	61276.....	97
5-429030.....	188	585-TG2.....	153	6006.....	111	6-1.....	70	61276LX.....	97
5-435005.....	189	585-TG3.....	153	6007.....	111	6101.....	111	6-12-8NM4SWP.....	134
5-435007.....	189	585-TG4.....	153	6011.....	111	6102.....	111	6-12-8NMP.....	134

## PART NUMBER INDEX cont'd

6-12-8NMSWP .....	134	620-302 .....	148	6223 .....	96	625-16-690 .....	150	6261BCX .....	106
6-12-8P .....	134	620-303 .....	148	62231 .....	98	625-183 .....	136	6261BL .....	106
6182 .....	117	620-304 .....	148	62231XX .....	98	6251CX .....	94	6261CX .....	106
6183 .....	117	620-306 .....	148	62232 .....	98	6251LX .....	94	6261MX .....	106
6-1838L .....	69	6203MX .....	100	62232XX .....	98	6252 .....	98	626-20 .....	144
6-1838S .....	69	620-400 .....	148	62236 .....	98	625-2132B .....	149	626-20S .....	144
6184 .....	117	620-401 .....	148	6223LX .....	96	625-2132V .....	149	626-20T .....	144
6-1846L .....	69	620-403 .....	148	6224 .....	94	625-2132W .....	149	626-23133 .....	145
6-1846S .....	69	620-404 .....	148	6224CX .....	94	625-2134B .....	149	626-23233 .....	145
6185 .....	117	620-405 .....	148	6226 .....	97	625-2134V .....	149	626-23333 .....	145
6186 .....	117	620-406 .....	148	6226CX .....	97	625-2134W .....	149	626-25 .....	144
6187 .....	117	620-408 .....	148	6227 .....	97	625-2139W .....	149	626-25S .....	144
6192 .....	117	620-409 .....	148	62273 .....	98	625-270W .....	148	626-25T .....	144
6193 .....	117	620-411 .....	148	6227CX .....	97	6252LX .....	98	626-26311 .....	145
6194 .....	117	620-500 .....	148	6227LX .....	97	625-304 .....	136	6-2626L .....	69
6195X .....	117	620-502 .....	148	6228 .....	97	625-305 .....	136	6262BCX .....	106
6197X .....	117	620-600 .....	148	6228LX .....	97	6253CX .....	98	6262BLX .....	106
6-2 .....	70	620-601 .....	148	6229 .....	94	6253LX .....	98	6262BMX .....	106
62000AX .....	106	620-602 .....	148	6229LX .....	94	6254 .....	97	6262CX .....	106
6200AX .....	100	620-603 .....	148	6230 .....	96	6254CX .....	97	6262LX .....	106
6200BSX .....	97, 100	620-604 .....	148	623-000 .....	155	6254LX .....	97	6262MX .....	106
6200BX .....	100	620-605 .....	148	623-001 .....	155	6255 .....	97	626-30 .....	144
6200CX .....	100	620-606 .....	148	623-002 .....	155	6255CX .....	97	626-30S .....	144
6200DX .....	100	620-607 .....	148	623-003 .....	155	6255LX .....	97	626-30T .....	144
6200HX .....	95, 100	620-608 .....	145	623-004 .....	155	6257 .....	98	626-38071 .....	145
6200MSX .....	100	620-6081 .....	145	623-005 .....	155	6257NX .....	98	626-38073 .....	145
6200MX .....	100	620-6082 .....	145	623-006 .....	155	6258 .....	95	626-38632 .....	145
6200X .....	100	620-6083 .....	145	623-007 .....	155	625-800 .....	136	626-38636 .....	145
620-10-2 .....	136	620-6-2 .....	136	623-008 .....	155	625-801 .....	136	6263BCX .....	106
620-12-2 .....	136	620-700 .....	148	623-012 .....	156	625-810 .....	136	6263BDX .....	106
620-14-2 .....	136	620-701 .....	148	623-013 .....	156	625-811 .....	136	6263BLX .....	106
620-18-10 .....	154	620-702 .....	148	623-014 .....	156	6258CX .....	95	6263BNX .....	106
620-18-12 .....	154	620-703 .....	148	6230CX .....	96	6259 .....	95	6263CX .....	106
620-18-2 .....	154	620-704 .....	148	6231 .....	96	6259CX .....	95	6263DX .....	106
620-18-2P .....	154	620-705 .....	148	6231CX .....	96	625-AF10 .....	31	6263LX .....	106
620-18-3 .....	154	6208 .....	96	6231LX .....	96	625-AF12 .....	31	6263NX .....	106
620-18-3P .....	154	620-8-2 .....	136	6232 .....	96	625-AF14 .....	31	626-3S .....	144
620-18-4 .....	154	6208LX .....	96	6232CX .....	96	625-AF6 .....	31	6264BCX .....	106
620-18-4P .....	154	6209 .....	96	6232LX .....	96	625-AF8 .....	31	6264BLX .....	106
620-18-5 .....	154	6209LX .....	96	6233 .....	94	625-B1 .....	150	6264BMX .....	106
620-18-5P .....	154	6210 .....	96	6233CX .....	94	625-CR15W .....	148	6264CX .....	106
620-18-6 .....	154	6210CX .....	96	6233LX .....	94	625-CR20W .....	148	6264LX .....	106
620-18-6P .....	154	6211 .....	96	6234 .....	94	625-CS120W .....	148	626-4S .....	144
620-18-7 .....	154	6211CX .....	96	6234LX .....	94	625-GD100 .....	149	6265BCX .....	106
620-18-8 .....	154	6212 .....	96	6235 .....	94	625-GD15H .....	149	6265BLX .....	106
620-18-8P .....	154	6212CX .....	96	6235CX .....	94	625-GD20H .....	149	6265CX .....	106
620-18-9 .....	154	6213 .....	94	6235LX .....	94	625-GD30H .....	149	6265LX .....	106
6201MX .....	100	6213CX .....	94	6236LX .....	98	625-GD40H .....	149	626-5s .....	144
620-200 .....	149	6214 .....	94	6237 .....	97	625-GD50H .....	149	6266BLX .....	106
620-201 .....	149	6214CX .....	94	6237LX .....	97	625-GD60H .....	149	626-6S .....	144
620-20-10 .....	154	6215 .....	98	6238 .....	97	625-GS15H .....	149	6267BCX .....	106
620-20134 .....	149	6215CX .....	98	6238LX .....	97	625-GS20H .....	149	6267BLX .....	106
620-202 .....	149	6216 .....	98	6239 .....	97	625-GS30H .....	149	6267MX .....	106
620-20-2 .....	154	6216CX .....	98	6239LX .....	97	625-GS40H .....	149	6268BL .....	106
620-20-3 .....	154	6216LX .....	98	623-MIX .....	155	625-GS50H .....	149	6268BMX .....	106
620-20-4 .....	154	6217 .....	96	6241 .....	96	625-IS5 .....	136	6268CX .....	106
620-20-5 .....	154	6217CX .....	96	6242 .....	96	625-S13 .....	149	6268MX .....	106
620-20-6 .....	154	6217LX .....	96	6-2424L .....	69	625-S14 .....	149	6269 .....	106
620-20-7 .....	154	6218 .....	94	6242LX .....	96	625-S15 .....	149	6269CX .....	106
620-20-8 .....	154	6218CX .....	94	6244 .....	96	625-S16 .....	149	6269LX .....	106
6-202-1 .....	82	6218LX .....	94	6244LX .....	96	625-S17 .....	149	6269MX .....	106
6-202-2 .....	82	6219 .....	94	6245 .....	96	625-S18 .....	149	626-AT0003 .....	145
620-252 .....	149	6219LX .....	94	6247 .....	98	625-S19 .....	149	626-AT0005 .....	145
620-253 .....	149	6220 .....	94	6247CX .....	98	625-S20 .....	149	626-HASR10 .....	144
620-254 .....	149	6220CX .....	94	6248 .....	98	625-S21 .....	149	626-HASR15 .....	144
620-255 .....	149	6221CX .....	94	6250 .....	96	626-10S .....	144	626-HASR20 .....	144
620-274W .....	149	6222 .....	96	6251 .....	94	626-10T .....	144	626-HASR25 .....	144
6202MX .....	100	62227 .....	98	6251-1225 .....	150	626-15 .....	144	626-HASR30 .....	144
620-300 .....	148	62228 .....	98	625-1301W .....	148	626-15S .....	144	6270 .....	95
620-301 .....	148	6222LX .....	96	625-16-6 .....	150	626-15T .....	144	6270LX .....	95

6271	95	6-321	178	6383-35	114	6526	108	6859	110
6271CX	95	6322	112	6384-325	114	6528	108	6863	110
6272	98	6-3263L	69	6384-35	114	660-002	173	6865	110
6-2739L	69	6-330	69	6401	109	660-003	173	6866	110
6273LX	95	6-330S	71	640-122	135	660-004	173	6868	110
6274	97	6330-4	114	640-142	135	660-005	173	6876	110
6-2748L	69	6330-6	114	6402	109	6601	109	6877	110
6-2748L-100	69	6330-9	114	6403	109	6602	109	6878	110
6-2748S	69	6331	114	6404	109	6603	109	6900AX	110
6274LX	97	6332B	114	6405	109	6604	109	6-9011	31
6276	97	6332G	114	640-845	136	6605	109	6943CX	110
6-2763L	69	6332R	114	640-AF2	36	6622	109	6945CX	110
6-2763S	69	6332W	114	640-AF25	36	6623	109	6946CX	110
6276LX	97	6333B	114	640-AF3	36	6641	109	6953CX	110
6277	95	6333G	114	640-FD2B	36	6642	109	6955CX	110
6277NX	95	6333R	114	640-FD2S	36	6643	109	6956CX	110
6278CX	117	6333W	114	640-FD3B	36	6644	109	6-9718	71
6279	117	6334B	114	640-FD3S	36	6645	109	6-CT700F	176
6279CX	117	6334G	114	640-FSK2	36	6682	109	6-DAMP221	170
6281	94	6334R	114	640-FSK3	36	6683	109	6-DCFM8906	168
6281LX	94	6334W	114	640-UL25	36	6685	109	6-DMM20UL	170
6282	94	6335B	114	640-UL3	36	6700AX	109	6-DMM45	170
6282LX	94	6335G	114	6411	109	6701	109	6-DT8803	177
6283	95	6335R	114	641-14	224	6702	109	6-DT898P	178
6283LX	95	6335W	114	6412	109	6703	109	6-FT80H	178
6284	95	6336	114	6413	109	6704	109	6-FT80R	178
6284LX	95	6337	114	6414	109	6704-2X	109	6-GPK035	169
6285	95	6338	114	6415	109	6706	109	6-HAB-BG	26
6285LX	95	6339	114	6416	109	6706-2X	109	6-HDT303K	177
6286	95	6339XL	114	6-5	70	6-7090	31	6-HG15	169
6286LX	95	6340	114	650-001	32	6722	109	6-HK2748	70
6287	96	6341	114	650-002	32	6722-2X	109	6-HK2748-1	70
6287NX	96	6342	114	650-003	32	6724	109	6-HK2748-SAM	252, 253
6287XX	96	6343	114	650-004	32	6724-2X	109	6-HK2766	70
6288	95	6-34-3NM	134	650-005	32	6730	109	6-HK2766-1	70
6288LX	95	6-34-4	134	650-006	32	6731	109	6-HK3050	70
6289	95	6-34-4NM	134	650-008	33	6732	109	6-HK3050-1	70
6289LX	95	6-34-4NMR	134	65001	108	6733	109	6-HK3060	70
6291	118	6-34-4R	134	650-010	33	6-733	71	6-HK3060-1	70
6291CX	118	6-34-6	134	650-011	32	6-734	71	6-IRT203	177
6292	118	6-3460	150	650-012	32	6735	109	6-IRT656	177
6292CX	118	6-34-6NM	134	650-013	32	6-735	71	6-IRT670	177
6293	118	6-34-6R	134	650-014	33	6-736	71	6-M2748	70
6293CX	118	6-34-8	134	650-015	33	675-P521U	153	6-M2763	70
6294	118	6-34-8NM	134	650-016	33	675-P621U	153	6-M3030	70
6294CX	118	6360B	114	650-017	33	675-P721UT	153	6-M3030-SAM	252, 253
6295X	118	6360R	114	65002	108	675-P722U	153	6-M3050	70
6296	118	6360W	114	650-020	33	675-PSD010BF	153	6-M3060	70
6296CX	118	6361B	114	650-021	32	675-PSD111	153	6-M3263	70
6298	118	6361R	114	650-023	32	675-PSDH121	153	6-OT550	178
6298LX	118	6361W	114	650-031	32	675-PSM30SA	153	6-PT300M	178
6-3	70	6362B	114	650-036	33	675-PSM40SA	153	6-PTH8708	178
6-3030L	69	6362R	114	650-038	32	675-PSP722E	153	6-R50A	31
6-3050	31	6362W	114	650-074	32	6800A	110	6-REF401	172
6-3050L	69	6-3636L	69	6500A	108	6800BX	110	6-RLD202	169
6-3050S	69	6363B	114	6501	108	6800HX	110	6-RLD382P	169
6-3060L	69	6363R	114	650-100	31	6822	110	6-SAM990DW	177
6-3060L-100	69	6363W	114	6501CX	108	6822DX	110	6-ST600LED	176
6-3060S	69	6364B	114	6502	108	6823	110	6-T1191	179
63070	118	6364R	114	650-200	31	6826DX	110	6-T1191BG	179
63076B	117	6364W	114	6503	108	6843	110	6-T133	179
63077B	117	6365B	114	650-300	31	6843DX	110	6-T135	179
63078B	117	6365R	114	6503CX	108	6845	110	6-T147	164
63079B	117	6365W	114	6505	108	6845DX	110	6-T152	179
6310X	112	6-3660L	69	6505LX	108	6846	110	6-T21	168
6311	112	6-3660S	69	6507	108	6848	110	6-T396	172
6312	112	6370	118	6-5070	31	6849	110	6-T482	180
6313	112	6371	118	6507LX	108	6853	110	6-T482A	180
6-320	178	6373	117	6513	111	6855	110	6-T582	172
6321	112	6383-325	114	6515	111	6858	110	6-T744	173

## PART NUMBER INDEX cont'd

6-T84101.....	173	710-185G.....	34	7317L.....	101	750-SLTC9050.....	136	7-ECC50730.....	165
6-T86014.....	168	7101CX.....	102	7317X.....	101	750-SLTC9075.....	136	7-ECC50735.....	165
6-TL100.....	176	7101HCX.....	102	7321X.....	101	7-58.....	71	7-I6V-B2.....	166
6-TL360W.....	176	7102CX.....	102	7-34.....	71	7-5811.....	156	7-ILJ2AA-B.....	166
701-001.....	182	7102HCX.....	102	7-341-18.....	249	7-5811-B.....	156	7-IN2.....	166
701-002.....	182	7103CX.....	102	7-3412.....	249	7-58P.....	71	7-IN2K.....	166
701-003.....	182	7103CX-6.....	102	7-341-38.....	249	7-60.....	26	7-IN2MS.....	166
701-004.....	182	7104.....	102	7-341-58.....	249	7-64.....	26	7-ISL2D-B.....	166
701-005.....	182	7-1058.....	249	7-342-18.....	249	7-6VGP.....	75	7-L300.....	33, 156
701-006.....	182	7105LX.....	102	7-342-58.....	249	7-6VHD.....	75	7-LK3A001.....	167
701-007.....	182	7106.....	102	7-3434.....	249	7-6VHDM.....	75	7-LM2A001.....	167
701-008.....	182	7106CX.....	102	7-3438.....	249	770-15.....	74	7-LUX2AA3W-B.....	166
701-009.....	182	7106X.....	102	7-3458.....	249	7-711.....	156	7-LWSA301.....	167
701-010.....	182	7-1078.....	249	7-3478.....	249	7-711-B.....	156	7-LWSA401.....	167
701-011.....	182	710-A16100.....	33	7-34P.....	71	7-75W.....	165	7-M2A016.....	167
701-012.....	182	710-A1650.....	33	7-38.....	71	7-78.....	71	7-M2A026.....	167
701-013.....	182	710-A1710.....	33	7-381-18.....	249	7-78P.....	71	7-M2A036.....	167
701-014.....	182	7-10KOTN30.....	144	7-3812.....	249	7-806.....	75	7-M3A016.....	167
701-015.....	182	7-10KOTN35.....	144	7-381-38.....	249	7-80632.....	81	7-P24.....	33, 156
701-017.....	182	7-10KOTN40.....	144	7-381-58.....	249	7-80633.....	81	7-P36.....	33, 156
701-018.....	183	7-10KOTN45.....	144	7-382-18.....	249	7-918.....	75	7-P36B.....	33, 156
701-019.....	183	7-10KOTN50.....	144	7-382-58.....	249	7-944.....	75	7-P48.....	33, 156
701-020.....	183	7-10KOTN60.....	144	7-383-18.....	249	799-001.....	79	7-P48B.....	33, 156
701-023.....	183	7-10P.....	71	7-3834.....	249	799-002.....	79	7-R2AA-B.....	166
701-024.....	183	710-P100.....	34	7-3838.....	249	799-003.....	79	7-R2D.....	166
701-025.....	183	7111.....	102	7-3858.....	249	799-004.....	79	7-R3D.....	166
701-026.....	183	7111CX.....	102	7-3878.....	249	799-005.....	79	7-RX1019.....	167
701-027.....	183	7111HCX.....	102	7-38P.....	71	799-006.....	79	7-S2C016.....	167
701-028.....	183	7111X.....	102	7-4000.....	82	799-008.....	79	7-S2D016.....	167
701-029.....	183	7-12.....	71	7-4001.....	82	799-009.....	79	7-S3D016.....	167
701-030.....	183	7-121-18.....	249	7-4100.....	82	799-010.....	79	7-S4C016.....	167
701-031.....	183	7-1212.....	249	741-001.....	78	799-011.....	79	7-S4D016.....	167
701-032.....	183	7-121-38.....	249	741-002.....	78	799-012.....	79	7-SE4W3C.....	166
701-033.....	183	7-121-58.....	249	7-4101.....	82	799-013.....	79	7-SPHW3AAA-BX.....	166
701-034.....	183	7-122-18.....	249	7-4200.....	82	799-020.....	79	7-TLC10625.....	165
701-035.....	183	7-122-58.....	249	7-4300.....	82	799-021.....	79	7-TLC10630.....	165
701-036.....	183	7-123-18.....	249	7-4400.....	82	799-022.....	79	800-008.....	82
701-037.....	183	7-1234.....	249	7-4500.....	82	799-024.....	79	800-009.....	82
701-038.....	183	7-1238.....	249	750-10100.....	135	799-025.....	79	8200M.....	112
701-039.....	183	7124CX.....	102	750-12100.....	135	799-026.....	79	8201.....	112
701-040.....	183	7124RX.....	102	750-12100BOX.....	135	799-040.....	79	8201C.....	112
701-041.....	182	7124X.....	102	750-30F-3PH.....	135	799-041.....	79	8202.....	112
701-042.....	182	7-1258.....	249	750-34100.....	135	7-AD010000.....	165	8202C.....	112
701-043.....	182	7-1278.....	249	750-401.....	191	7-AL9V.....	75	8203.....	112
701-046.....	183	7-12P.....	71	750-402.....	191	7-AL9V-8.....	75	8203C.....	112
701-047.....	183	7-14.....	71	750-500.....	135	7-ALAA.....	75	8206.....	112
701-053.....	182	7142.....	101	750-600.....	135	7-ALAA-24.....	75	8207.....	112
701-055.....	183	7142LX.....	101	750-60F-3PH.....	135	7-ALAAA.....	75	8208.....	112
7032.....	108	7143.....	101	750-60NF-3PH.....	135	7-ALAAA-18.....	75	8220M.....	112
7033.....	108	7143LX.....	101	750-MLT50.....	136	7-ALC.....	75	8233.....	112
7034.....	108	7146.....	101	750-MLT75.....	136	7-ALC-12.....	75	8282.....	118
7036X.....	108	7147.....	101	750-MLT9050.....	136	7-ALD.....	75	8282LX.....	118
7063.....	108	7-14P.....	71	750-MLT9075.....	136	7-ALD-12.....	75	8284.....	118
7064.....	108	7-200.....	82	750-NMLT100.....	136	7-AM2A056.....	167	8284CX-B.....	118
7066NX.....	108	7233RLX.....	101	750-NMLT150.....	136	7-CRNR15.....	144	8286.....	118
7066X.....	108	7234RLX.....	101	750-NMLT200.....	136	7-CRNR20.....	144	8286CX.....	118
708-850.....	140	7235RLX.....	101	750-NMLT4550.....	136	7-CRNR25.....	144	8286CX-B.....	118
7-10.....	71	7236R.....	101	750-NMLT4575.....	136	7-CRNR30.....	144	829-995.....	140
7-100.....	82	7236RLX.....	101	750-NMLT50.....	136	7-CRNR35.....	144	88-108.....	140
710-001.....	34	72-88220.....	140	750-NMLT75.....	136	7-CRNR40.....	144	88-108220.....	140
710-002.....	34	72-88330.....	140	750-NMLT90100.....	136	7-CRNR45.....	144	88-108330.....	140
710-003.....	34	7301.....	101	750-NMLT90150.....	136	7-CRNR50.....	144	8-FWH16.....	84
710-004.....	34	7-301K.....	166	750-NMLT90200.....	136	7-CRNR60.....	144	8-WH16.....	84
710-005.....	34	7302.....	101	750-NMLT9050.....	136	7-ECC12100.....	165	900-3.....	41
7-100W.....	165	7303.....	101	750-NMLT9075.....	136	7-ECC1225.....	165	900-4.....	41
710-100.....	34	7311L.....	101	750-P60NF.....	135	7-ECC1250.....	165	900-5.....	41
710-101.....	34	7311X.....	101	750-RC841.....	136	7-ECC16100.....	165	900-6.....	41
710-102.....	34	7-316.....	71	750-RC842.....	136	7-ECC1625.....	165	91-2032.....	43
710-103.....	34	7316L.....	101	750-SLTC50.....	136	7-ECC1650.....	165	91-3042.....	43
710-182G.....	34	7316X.....	101	750-SLTC75.....	136	7-ECC50725.....	165	92-3232.....	43

**PART NUMBER INDEX cont'd**

92-4242.....	43	ATK-1.....	231	B-502.....	161	BPF-10.....	44	BPN-51.....	43
A60306K.....	133	ATK-1P.....	231	B-503.....	161	BPF-11.....	44	BPN-52.....	43
ACB-30.....	27	ATK-4.....	231	B-504.....	161	BPF-12.....	44	BPN-53.....	43
ACB-36.....	27	AW-712.....	161	B-505.....	161	BPF-13.....	44	BPN-54.....	43
ACB-42.....	27	AW-712-10.....	161	B-602.....	163	BPF-14.....	44	BPN-6.....	43
ACB-48.....	27	AW-712-8.....	161	B-604.....	163	BPF-15.....	44	BPN-7.....	43
ACID-ELIM.....	233	AW-8.....	161	B-607.....	163	BPF-16.....	44	BPN-8.....	43
ACK4.....	176	AW-9.....	161	B-610.....	163	BPF-17.....	44	BPN-9.....	43
ACP-10.....	74	AW-96.....	161	B6-12-4.....	134	BPF-18.....	44	BPN-A1.....	43
ACP24242.....	24	AW-96-10.....	161	B6-12-4NM.....	134	BPF-19.....	44	BPN-A12.....	43
ACP24243.....	24	AW-96-8.....	161	B6-12-6.....	134	BPF-20.....	44	BPN-A34.....	43
ACP24362.....	24	AWL-5.....	161	B6-12-6NM.....	134	BPF-21.....	44	BS-16.....	227
ACP30302.....	24	AWL-9.....	161	B-613.....	163	BPF-22.....	44	BS-25.....	69
ACP30303.....	24	AWZ-2500.....	161	B-616.....	163	BPF-23.....	44	BS-32.....	227
ACP32322.....	24	AWZ-3000.....	161	B-619.....	163	BPF-24.....	44	BS-64.....	227
ACP32323.....	24	B-1.....	161	B-622.....	163	BPF-25.....	44	C10.....	160
ACP32442.....	24	B-10.....	163	B-628.....	163	BPF-26.....	44	C101-0025.....	236
ACP36362.....	24	B-10H.....	190	B-633.....	163	BPF-27.....	44	C101-0050.....	236
ACP36363.....	24	B-124.....	162	B6-34-4.....	134	BPF-28.....	44	C101-0057.....	236
ACP36483.....	24	B-125.....	162	B6-34-4NM.....	134	BPF-29.....	44	C101-0058.....	236
ACP38422.....	24	B-126.....	162	B6-34-6.....	134	BPF-30.....	44	C101-0100.....	236
ACT-6.....	170	B-127.....	162	B6-34-6NM.....	134	BPF-31.....	44	C101-0107.....	236
ADB-1.....	145	B-128.....	162	B-6H.....	190	BPF-32.....	44	C101-0150.....	236
ADB-2.....	145	B-129.....	162	B-702.....	163	BPF-33.....	44	C101-0159.....	236
ADM-1.....	145	B-12H.....	190	B-704.....	163	BPF-34.....	44	C101-0215.....	236
ADM-2.....	145	B-130.....	162	B-707.....	163	BPN-1.....	43	C101-0222.....	236
AFB1212-1.....	35	B-131.....	162	B-710.....	163	BPN-10.....	43	C101-0295.....	236
AFB1220-1.....	35	B-132.....	162	B-713.....	163	BPN-11.....	43	C101-0390.....	236
AFB1224-1.....	35	B-16H.....	190	B-716.....	163	BPN-12.....	43	C105-0050.....	236
AFB1420-1.....	35	B-2.....	161	B-719.....	163	BPN-13.....	43	C105-0057.....	236
AFB1424-1.....	35	B-202.....	163	B-722.....	163	BPN-14.....	43	C105-0058.....	236
AFB1425-1.....	35	B-204.....	163	B-728.....	163	BPN-15.....	43	C105-0100.....	236
AFB1520-1.....	35	B-207.....	163	B-733.....	163	BPN-16.....	43	C105-0107.....	236
AFB1624-1.....	35	B-20H.....	190	B-802.....	163	BPN-17.....	43	C105-0150.....	236
AFB1625-1.....	35	B-210.....	163	B-804.....	163	BPN-18.....	43	C105-0159.....	236
AFB1818-1.....	35	B-213.....	163	B-807.....	163	BPN-19.....	43	C105-0215.....	236
AFB2024-1.....	35	B-216.....	163	B-810.....	163	BPN-2.....	43	C105-0295.....	236
AFB2025-1.....	35	B-219.....	163	B-813.....	163	BPN-20.....	43	C105-0390.....	236
AFB2030-1.....	35	B-222.....	163	B-816.....	163	BPN-21.....	43	C114-0050.....	236
AFB2424-1.....	35	B-228.....	163	B-819.....	163	BPN-22.....	43	C114-0100.....	236
AFB2525-1.....	35	B-233.....	163	B-822.....	163	BPN-23.....	43	C114-0150.....	236
AFB-CUSTOM-1.....	35	B-24H.....	190	B-8H.....	190	BPN-24.....	43	C114-0215.....	236
AFB-CUSTOM-2.....	35	B-26.....	163	B-924.....	162	BPN-25.....	43	C114-0295.....	236
AFR1220-1.....	35	B-27.....	161	B-925.....	162	BPN-26.....	43	C114-0390.....	236
AFR1224-1.....	35	B-28H.....	190	B-926.....	162	BPN-27.....	43	C115-0050.....	236
AFR1420-1.....	35	B-302.....	163	B-927.....	162	BPN-28.....	43	C115-0100.....	236
AFR1424-1.....	35	B-304.....	163	B-928.....	162	BPN-29.....	43	C115-0150.....	236
AFR1425-1.....	35	B-307.....	163	B-929.....	162	BPN-3.....	43	C115-0215.....	236
AFR1430-1.....	35	B-310.....	163	B-930.....	162	BPN-30.....	43	C115-0295.....	236
AFR1520-1.....	35	B-313.....	163	B-931.....	162	BPN-31.....	43	C115-0390.....	236
AFR1620-1.....	35	B-316.....	163	B-932.....	162	BPN-32.....	43	C1-2-6.....	160
AFR1625-1.....	35	B-319.....	163	B-934.....	162	BPN-33.....	43	C142-0057.....	238
AFR1824-1.....	35	B-322.....	163	B-935.....	162	BPN-34.....	43	C142-0058.....	238
AFR1825-1.....	35	B-328.....	163	B-996.....	162	BPN-35.....	43	C154-0002.....	238
AFR2020-1.....	35	B-32H.....	190	B-998.....	162	BPN-37.....	43	C154-0025.....	238
AFR2024-1.....	35	B-333.....	163	BE-24.....	163	BPN-38.....	43	C154-0050.....	238
AFR2025-1.....	35	B-36H.....	190	BE-36.....	163	BPN-39.....	43	C154-0090.....	238
AFR2030-1.....	35	B-4.....	161	BE-48.....	163	BPN-4.....	43	C154-0100.....	238
AFR2525-1.....	35	B-402.....	163	BH-1.....	163	BPN-40.....	43	C154-0150.....	238
AFR-CUSTOM-1.....	35	B-404.....	163	BNT-1.....	228	BPN-41.....	43	C154-0215.....	238
AFR-CUSTOM-2.....	35	B-407.....	163	BNT-32.....	228	BPN-42.....	43	C154-0295.....	238
AG-25.....	82	B-410.....	163	BPF-01.....	43	BPN-43.....	43	C165-0001.....	237
ALK150-01.....	231	B-413.....	163	BPF-02.....	43	BPN-44.....	43	C165-0002.....	237
ALK150-05.....	231	B-416.....	163	BPF-03.....	43	BPN-45.....	43	C165-0007.....	238
ALK200-01.....	231	B-419.....	163	BPF-04.....	43	BPN-46.....	43	C165-0025.....	237
ALK300-01.....	231	B-422.....	163	BPF-05.....	43	BPN-47.....	43	C165-0032.....	238
ALK300-05.....	231	B-428.....	163	BPF-06.....	43	BPN-48.....	43	C165-0050.....	237
AP-DD.....	69	B-433.....	163	BPF-07.....	44	BPN-49.....	43	C165-0058.....	238
AP-DK.....	69	B-4H.....	190	BPF-08.....	44	BPN-5.....	43	C165-0059.....	238
AT-1700.....	150	B-501.....	161	BPF-09.....	44	BPN-50.....	43	C165-0090.....	237

## PART NUMBER INDEX cont'd

C165-0093	238	C272-0025	236	C460-0235	239	CC33	151	CRC-8	77
C165-0094	238	C272-0050	236	C460-0236	239	CC33-18	151	CRC-9	78
C165-0100	237	C272-0090	236	C460-0237	239	CC33-24	151	CS-1	67
C165-0107	238	C272-0100	236	C460-0245	239	CD-9000-B	41	CS1200	67
C165-0149	238	C272-0150	236	C460-0246	239	CD-9775-C	41	CS-2	67
C165-0150	237	C272-0215	236	C460-0247	239	CG-AER	223	CS-3	67
C165-0159	238	C272-0295	236	C460-0248	239	CGB-AER	223	CT-475M	160
C165-0215	237	C290-0002	237	C460-0256	239	CH-100	147	CT800	176
C165-0222	238	C290-0025	237	C460-0295	239	CH-100-3	147	CTH-1	33, 156
C165-0223	238	C290-0050	237	C460-0303	239	CH-101	147	CVENT-2	41
C165-0224	238	C290-0090	237	C460-0304	239	CH-101-1	147	CVENT-3	41
C165-0295	237	C290-0100	237	C460-0305	239	CH-101-2	147	CVMINI	66
C165-0303	238	C290-0150	237	C460-0315	239	CH-101-3	147	CV-PTRAP	68
C165-0304	238	C290-0215	237	C460-0316	239	CH-102	147	CV-RTRAP	68
C165-0305	238	C290-0295	237	C460-0317	239	CH-102-2	147	CV-TUBE	68
C165-0306	238	C290-0390	237	C460-0318	239	CH-102-3	147	CW-15	69
C165-0390	237	C295-0002	237	C460-0319	239	CH-103	147	CW-30	160
C165-0398	238	C295-0025	237	C460-0329	239	CH-103-2	147	D10	142
C165-0399	238	C295-0050	237	C460-0330	239	CH-104	147	D11	142
C165-0400	238	C295-0090	237	C460-0331	239	CH-104-3	147	D20-3132-18	42
C165-0401	238	C295-0100	237	C460-0332	239	CH-105	147	D20-3132-24	42
C165-0402	238	C295-0150	237	C460-0339	239	CH-135	147	D20-3132-36	42
C165-1498	238	C295-0215	237	C460-0340	239	CH-135-2	147	D20-3132-48	42
C170-0003	239	C295-0295	237	C460-0341	239	CH-196	147	D30-3131-24	42
C172-0050	239	C295-0390	237	C460-0342	239	CH-196-2	147	D30-3131-36	42
C172-0100	239	C312	156	C460-0343	239	CH-196-3	147	D30-3131-48	42
C172-0150	239	C312L	156	C460-0350	239	CH-196-6	147	D30-3132-18	42
C172-0215	239	C410-0007	238	C460-0390	239	CH-197	147	D30-3132-24	42
C20	160	C410-0032	238	C460-0398	239	CH-202-3	147	D30-3132-36	42
C20-D	160	C410-0033	238	C460-0399	239	CH-230	147	D30-3132-48	42
C222	156	C410-0058	238	C460-0400	239	CH-230-3	147	D40620250B3B6	247
C222C	156	C410-0059	238	C460-0401	239	CH-230-6	147	D40620350B3B6	247
C223	156	C410-0093	238	C460-0402	239	CH-280	147	D40620500B3B6	247
C223C	156	C410-0107	238	C460-0413	239	CK-141	69	D40680250B3B6	247
C235-0002	236	C410-0149	238	C460-0414	239	CLL-1	232	D40680350B3B6	247
C235-0025	236	C410-0159	238	C460-0415	239	CLL-16	232	D40680500B3B6	247
C235-0050	236	C410-0160	238	C460-0416	239	CLL-4	232	D40820250B3B6	247
C235-0090	236	C410-0161	238	C460-0417	239	CO-1	78	D40820350B3B6	247
C235-0100	236	C410-0222	238	C460-0418	239	COOLWELD-32	223	D40820500B3B6	247
C235-0150	236	C410-0223	238	C460-0419	239	CP-16	66	D40880250B3B6	247
C235-0215	236	C410-0224	238	C460-0430	239	CP-16-230	66	D40880350B3B6	247
C235-0295	236	C410-0303	238	C460-0431	239	CP-22	66	D40880500B3B6	247
C235-0390	236	C410-0304	238	C460-0432	239	CP-22-230	66	D41020250B3B6	247
C241	156	C410-0305	238	C460-0433	239	CP-22-230T	66	D41020350B3B6	247
C242-0001	237	C410-0306	238	C460-0444	239	CP-22LP	66	D41020500B3B6	247
C242-0002	237	C410-0398	238	C460-0447	239	CP-22LP-230	66	D41080250B3B6	247
C242-0015	237	C410-0399	238	C460-0457	239	CP-22T	66	D41080350B3B6	247
C242-0025	237	C410-0400	238	C460-0470	239	CP-CV	66	D41080500B3B6	247
C242-0050	237	C410-0401	238	C5	160	CP-CVCF	66	D60A-10	242
C242-0090	237	C410-0402	238	C512	156	CPN1	156	D60A-4	242
C242-0100	237	C410-1498	238	C512L	156	CPN1C	156	D60A-6	242
C242-0150	237	C460-0002	239	C533-0050	239	CPN2	156	D60A-8	242
C242-0215	237	C460-0025	239	C533-0150	239	CPN2C	156	D61020250B3B6	247
C242-0295	237	C460-0050	239	C533-0215	239	CPN3	156	D61020350B3B6	247
C242-0390	237	C460-0057	239	C533-0295	239	CPN3C	156	D61020500B3B6	247
C243	156	C460-0058	239	C533-0390	239	CRO70	175	D61080250B3B6	247
C245	156	C460-0090	239	C657-0100	238	CRC-1	78	D61080350B3B6	247
C247	156	C460-0100	239	C947-0025	239	CRC-13	78	D61080500B3B6	247
C2-5	160	C460-0107	239	C947-0050	239	CRC-1KB	77	D61220250	247
C254-0002	237	C460-0117	239	C947-0090	239	CRC-2	78	D61220350	247
C254-0025	237	C460-0118	239	C947-0100	239	CRC-3	78	D61220500	247
C254-0050	237	C460-0150	239	C947-0150	239	CRC-4-140	75	D61230250	247
C254-0090	237	C460-0159	239	C947-0215	239	CRC-4CF	75	D61230350	247
C254-0100	237	C460-0160	239	C947-0295	239	CRC-4NU	76	D61230500	247
C254-0150	237	C460-0180	239	C947-0390	239	CRC-5	78	D61280250	247
C254-0215	237	C460-0181	239	CA-252C	160	CRC-6	78	D61280350	247
C254-0295	237	C460-0182	239	CAS-2712	81	CRC-7-140	76	D61280500	247
C254-0390	237	C460-0215	239	CB-03	69	CRC-7PS	76	D61420250	247
C2-5S	160	C460-0222	239	CB-2	68	CRC-7X	76	D61420350	247
C272-0002	236	C460-0223	239	CC-1	67	CRC-7Z	76	D61420500	247

D61430250	247	DAD083S	245	DNS4-6	243	DST-6	140	ED1232	116
D61430350	247	DAD084S	245	DNS4-8	243	DT2-10	243	ED1238	116
D61430500	247	DAD163	245	DP2-10	244	DT2-4	243	ED1240-2	116
D61480250	247	DAD163S	245	DP2-4	244	DT2-6	243	ED1262-2	116
D61480350	247	DAD164S	245	DP252120	141	DT2-8	243	ED1262-2I	116
D61480500	247	DAD303	245	DP25224	141	DTP-3	146	ED1301	116
D61820250	247	DAD303S	245	DP252240	141	DTT-10	77	ED1301-I	116
D61820350	247	DAD304S	245	DP2-6	244	DTT-24	77	ED1703	115
D61820500	247	DAD305	245	DP2-8	244	DU1-10D	243	ED1709	115
D61880250	247	DAD305S	245	DP301120	141	DU1-10E	243	ED1711	115
D61880350	247	DBF083	246	DP30124	141	DU1-12D	243	ED179	115
D61880500	247	DBF083S	246	DP301240	141	DU1-12E	243	ED1876	116
D61A-10	242	DBF084	246	DP302120	141	DU1-4A	243	ED1876-I	116
D61A-4	242	DBF084S	246	DP30224	141	DU1-4B	243	ED1877	116
D61A-6	242	DBF163	246	DP302240	141	DU1-6B	243	ED252	115
D61A-8	242	DBF163S	246	DP303120	141	DU1-6C	243	ED270	116
D62A-1010	242	DBF164S	246	DP30324	141	DU1-6D	243	ED270-I	116
D62A-44	242	DBF165S	246	DP303240	141	DU1-6E	243	ED273	107
D62A-66	242	DC30-3132-18	42	DP304120	141	DU1-8B	243	ED273CX	107
D62A-88	242	DC30-3132-24	42	DP30424	141	DU1-8C	243	ED277	116
D64A-1010	243	DC30-3132-36	42	DP304240	141	DU1-8D	243	ED277-I	116
D64A-44	243	DC30-3132-48	42	DP304277	141	DU1-8E	243	ED2867	115
D64A-66	243	DD11	142	DP402120	141	DU2-10	244	ED2887	115
D64A-88	243	DDS-30	135	DP40224	141	DU2-12	244	ED302	117
D68A-4A	242	DDS-60	135	DP402240	141	DU2-14	244	ED304	117
D68A-4B	242	DDS-60U	135	DP403120	141	DU2-4	244	ED312	117
D68A-6B	242	DE1-10D	243	DP40324	141	DU2-6	244	ED320	117
D68A-6C	242	DE1-12D	243	DP403240	141	DU2-8	244	ED406	107
D68A-6D	242	DE1-12E	242	DP404120	141	DU3-10D	244	ED419	115
D68A-8D	242	DE13	108	DP40424	141	DU3-10E	244	ED4409	115
D69A-4A	242	DE14	108	DP404240	141	DU3-6C	244	ED447	116
D69A-4B	242	DE1-4B	242	DP404277	141	DU3-6D	244	ED4509	115
D69A-6B	242	DE15	108	DP503120	141	DU3-8C	244	ED453	116
D69A-6C	242	DE1-6B	243	DP50324	141	DU3-8D	244	ED454	116
D69A-6D	242	DE1-6C	242	DP503240	141	DUCT-FRESH-16	228	ED455	116
D69A-8D	242	DE1-6D	243	DP603120	141	DUCT-FRESH-32	228	ED468	116
D-90113	143	DE1-8C	243	DP60324	141	DUCT-FRESH-48	228	ED4687	115
D-90118	143	DE1-8D	242	DP603240	141	DUCT-FRESH-8	228	ED494	116
D90-290Q	143	DE1-8E	243	DP753120	141	DUS4-4	244	ED5225	116
D90-291Q	143	DE22	112	DP75324	141	DUS4-6	244	ED600	118
D90-292Q	143	DE23	108	DP753240	141	DUS4-8	244	ED601	118
D90-293Q	143	DE24	108	DP903120	141	DX-3	245	ED602	118
D90-294Q	143	DE25	108	DP90324	141	DX-4	245	ED603	118
D90-295Q	143	DE26	108	DP903240	141	DXA-5	245	ED604	118
D-90340	143	DE33	108	DPRO63	143	E-10	171	ED610	118
D-90341	143	DEP052	81	DPRO64	143	E-5	171	ED611	118
D-90342	143	DEP056	81	DPRO65	143	E-6	171	ED612	118
D90-360	143	DEP8001	81	DPRO66	143	E-8	171	ED613	118
D90-362	143	DEP8002	81	DPRO67	143	EB-10	171	ED620	118
D90-364	143	DETECTO-8	228	DPRO68	143	EB-6	171	ED621	118
D90-370	143	DF-75	69	DPRO69	143	EB-8	171	ED622	118
D90-372	143	DMB-1	133	DPSG-2	246	EC-1	31	ED623	118
D90-374	143	DMB-2	133	DPSG-2MF	246	EC302120	141	ED710	118
D90-380	143	DMB-3	133	DPSG-2S	246	EC30224	141	ED711	118
D90-382	143	DN1-10	243	DPSG-3	246	EC302240	141	ED712	118
D90-384	143	DN1-12	243	DPSG-3MF	246	EC303120	141	ED713	118
DA2V02	142	DN1-14	243	DPSG-3S	246	EC30324	141	ED714	118
DA2V06	142	DN1-3	243	DPSG-4	246	EC303240	141	ED877	116
DA2V09	142	DN1-4	243	DPSG-4MF	246	EC402120	141	ED877-I	116
DA2V14	142	DN1-5	243	DPSG-5	246	EC40224	141	ED9726	116
DA3V02	142	DN1-6	243	D-SCALE	231	EC402240	141	ED-AT3	113
DA3V06	142	DN1-8	243	DSL13-5SVHH	245	EC403120	141	ED-AT5	113
DA3V09	142	DN5-10	243	DSL13-6SVHH	245	EC40324	141	ED-CR15	113
DAD032	245	DN5-4	243	DSL127-7SVHH	245	EC403240	141	ED-CR20	113
DAD032S	245	DN5-6	243	DSL127-9SVHH	245	EC-56	171	ED-CR25	113
DAD052	245	DN5-8	243	DSL154-11SVHH	245	EC-810	171	ED-CR30	113
DAD052S	245	DNS4-10	243	DSP-1	146	ECO-COIL	222	ED-CR35	113
DAD053S	245	DNS4-12	243	DSS-SLD306SV	245	ECO-COIL-32	222	ED-CR40	113
DAD082	245	DNS4-14	243	DSS-SLD307SV	245	ECO-COIL-5	222	ED-CR45	113
DAD082S	245	DNS4-4	243	DST-5	140	ECO-COIL-55	222	ED-CR50	113

**PART NUMBER INDEX** cont'd

ED-CR60.....	113	FAK-10.....	80	H5557-4.....	23	HS24.....	151	LIT-FLY-FPIC.....	252
EDS-60U.....	135	FAK-25.....	80	HC-1.....	23	HS-30.....	175	LIT-FLY-GG.....	252
EG.....	225	FB-1.....	26	HC-1-100.....	23	HS-30-2.....	175	LIT-FLY-HEAT.....	252
EG-5.....	225	FC-73.....	40	HC5410.....	111	HS32.....	151	LIT-FLY-HEF.....	252
EG-55.....	225	FC-74.....	40	HC5410X.....	111	HS-60.....	175	LIT-FLY-HPAD.....	252
EH-1.....	171	FC-82.....	40	HC5416.....	111	HS-60-2.....	175	LIT-FLY-HRP.....	252
EL1838-3.....	21	FC-87.....	41	HC5416X.....	111	HSA1.....	151	LIT-FLY-HSI.....	252
EL2424-2.....	21	FF-1000-S.....	203	HC5420.....	111	HSA2.....	151	LIT-FLY-LS.....	252
EL2424-3.....	21	FF-250-S.....	203	HC5420X.....	111	HSK1.....	140	LIT-FLY-MDP.....	252
EL2430-2.....	21	FF-250-UNI.....	203	HC5424.....	111	HSK5.....	140	LIT-FLY-MOTORS.....	252
EL2430-3.....	21	FF-400-S.....	203	HC5436.....	111	HT1840-4.....	23	LIT-FLY-MSPLIT.....	252
EL2436-2.....	21	FF-600-S.....	203	HC5436X.....	111	HT2424-4.....	23	LIT-FLY-PF.....	252
EL2436-3.....	21	FH-1.....	145	HC6202.....	111	HT2436-4.....	23	LIT-FLY-PF-S.....	252
EL2626-2.....	21	FLOW-PLUS-10.....	229	HC6203.....	111	HT3030-4.....	23	LIT-FLY-PUMP.....	252
EL3030-2.....	21	FLOW-PLUS-125.....	229	HCO-128.....	76	HT3232-4.....	23	LIT-FLY-SCAP.....	252
EL3030-3.....	21	FLOW-PLUS-200.....	229	HCO-15.....	76	HT3345-4.....	23	LIT-FLY-SPRAYER.....	252
EL3036-2.....	21	FLOW-PLUS-25.....	229	HCO-64.....	76	HT3636-4.....	23	LIT-FLY-SPRAYER-S.....	252
EL3040-2.....	21	FLOW-PLUS-6.....	229	HCO-7.....	76	HT3648-4.....	23	LIT-FLY-UC.....	252
EL3040-3.....	21	FM0450.....	33	HCP-15.....	76	HT3842-4.....	23	LIT-FLY-UCSTRAP.....	252
EL3232-2.....	21	FRESH-COIL.....	223	HCP-7.....	76	HT3852-4.....	23	LIT-FLY-UV.....	252
EL3232-3.....	21	FTL3.....	176	HDR-101.....	152	HT4040-4.....	23	LIT-FLY-WS.....	252
EL3238-2.....	21	FTL3D.....	176	HDR-102.....	152	HT4242-4.....	23	LS-1.....	233
EL3238-3.....	21	FUL0425.....	33	HDR-201.....	152	HT4558-4.....	23	LS-2.....	233
EL3244-2.....	21	FUL0625.....	33	HDR-202.....	152	HVENT-2.....	41	M-1.....	171
EL3244-3.....	21	GA-06.....	160	HDR-211.....	152	HVENT-3.....	41	M-1R.....	171
EL3434-2.....	21	GA-30.....	160	HDR-212.....	152	IC-1.....	68	M-2.....	171
EL3636-2.....	21	GAU225-PURGE.....	160	HDR-221.....	152	IC-1R.....	68	M-2R.....	171
EL3636-3.....	21	GC275.....	150	HDR-222.....	152	IGN-001.....	40	M-3.....	171
EL3640-2.....	21	GC277.....	150	HEK-100.....	152	IGN-1F.....	40	M-3G.....	171
EL3640-3.....	21	GG-1.....	68	HEK-200.....	152	IGN-1R.....	40	M-3R.....	171
EL3648-2.....	21	GG-1A.....	68	HEK-400.....	152	IGN-2.....	40	M-4.....	171
EL3648-3.....	21	GG-1BOR.....	68	HEK-500.....	152	IGN-2-6P.....	40	M-4R.....	171
EL3842-2.....	21	GG-1H.....	68	HFL-4257.....	152	IGN-401.....	40	M-5.....	171
EL3842-3.....	21	GG-1NHL.....	68	HFL-4300.....	152	IGN-402.....	40	M-5G.....	171
EL3870-3.....	21	GG-1TF.....	68	HFL-4333.....	152	IGN-403.....	40	M-5R.....	171
EL4040-3.....	21	GGC-12.....	68	HFL-5257.....	152	IGN-409.....	40	MB21.....	151
EL4558-3.....	21	GGC-6.....	68	HFL-5258.....	152	IQP-120.....	66	MB22.....	151
EL4848-3.....	21	GN-23H.....	83	HFL-5300.....	152	IQP-120T.....	66	MBK-6.....	68
EL4872-3.....	21	GPI-4OBL.....	83	HFL-5301.....	152	IQP-KUBE.....	66	MG-1.....	168
EL5252-3.....	21	GT-750.....	160	HFL-5333.....	152	IQP-KUBE-SHROUD.....	66	MG-ORING.....	168
EL5658-3.....	21	GV04.....	151	HMD1844-4.....	23	IRT657.....	177	MG-RGB.....	168
EM217.....	113	GV05.....	151	HMD2436-4.....	23	ISO-18.....	28	MG-RGR.....	168
EM469.....	113	GV06.....	151	HMD3030-4.....	23	ISO-2.....	28	MHP-4.....	171
EM480.....	117	GV07.....	151	HMD3636-4.....	23	ISO-4.....	28	MICN109.....	41
EM484.....	117	GV08.....	151	HMD3642-4.....	23	JB8265.....	81	MKT-BANNER.....	253
EP1838-3.....	25	GV10.....	151	HMD3648-4.....	23	LIT-CAT-CD.....	252	MKT-DEMO-SCAP.....	252
EP2424-2.....	25	GV12.....	151	HMD4040-4.....	23	LIT-CAT-HVAC.....	252	MKT-POP-BROCH.....	252
EP2424-3.....	25	GV14.....	151	HMR-130.....	152	LIT-CAT-NEW.....	252	MKT-POP-BROCH4.....	252
EP3030-2.....	25	GV16.....	151	HP3636-8.....	25	LIT-FLY-3D.....	252	MKT-POP-CDLC.....	253
EP3030-3.....	25	GVA1.....	151	HPR-12.....	26	LIT-FLY-3D-S.....	252	MKT-POP-CHEM.....	253
EP3232-2.....	25	GVA2.....	151	HPR-3.....	26	LIT-FLY-3PHASE.....	252	MKT-POP-CLRGOND.....	253
EP3232-3.....	25	H1840-4.....	23	HPR-3-2P.....	26	LIT-FLY-AVPAD.....	252	MKT-POP-CLRKIT.....	253
EP3244-2.....	25	H2424-4.....	23	HPR-3-2PG.....	26	LIT-FLY-BPPOOL.....	252	MKT-POP-CLRSHELF.....	253
EP3244-3.....	25	H2436-4.....	23	HPR-6.....	26	LIT-FLY-CDLC.....	252	MKT-POP-CLRSTAND.....	253
EP3636-2.....	25	H3030-4.....	23	HPR-6-2P.....	26	LIT-FLY-CLAD.....	252	MKT-POP-CP22.....	253
EP3636-3.....	25	H3060-4.....	23	HPR-6-2PG.....	26	LIT-FLY-CLRVUE.....	252	MKT-POP-CVTUBE.....	253
EP3648-3.....	25	H3232-4.....	23	HPR-EXT.....	26	LIT-FLY-COND.....	252	MKT-POP-DEV16.....	253
EP3842-2.....	25	H3345-4.....	23	HP-SB-16.....	226	LIT-FLY-CS1200.....	252	MKT-POP-DEVBACKS.....	253
EP4040-3.....	25	H3434-4.....	23	HP-SK-16.....	226	LIT-FLY-CV.....	252	MKT-POP-DEVBACKSSLAT.....	253
ET130C1.....	150	H3636-4.....	23	HP-SKDP-20.....	226	LIT-FLY-CVKUBE.....	252	MKT-POP-DEVCOMBO.....	253
ET22.....	150	H3642-4.....	23	HP-SKDS-16.....	226	LIT-FLY-CVKUBE-S.....	252	MKT-POP-DEVELEC.....	253
ET33.....	150	H3648-4.....	23	HS012.....	151	LIT-FLY-CVMINI.....	252	MKT-POP-DEVEZC.....	253
ET35G.....	150	H3652-4.....	23	HS03.....	151	LIT-FLY-CVMINI-S.....	252	MKT-POP-DTBACKS.....	253
ET35N.....	150	H3672-4.....	23	HS04.....	151	LIT-FLY-DISC.....	252	MKT-POP-DTBACKSSLAT.....	253
ET35R.....	150	H3842-4.....	23	HS06.....	151	LIT-FLY-DS.....	252	MKT-POP-DUCT.....	253
ET35W.....	150	H3852-4.....	23	HS08.....	151	LIT-FLY-DST10.....	252	MKT-POP-DUCTSAM.....	252
ET44.....	150	H3865-4.....	23	HS-144.....	175	LIT-FLY-DTP3.....	252	MKT-POP-EASEL.....	252
FA-01.....	69	H4040-4.....	23	HS16.....	151	LIT-FLY-DTP3ES.....	252	MKT-POP-HSI.....	253
FA-02.....	69	H4242-4.....	23	HS-168HD.....	175	LIT-FLY-ELITE.....	252	MKT-POP-LS.....	253
FA-03.....	69	H4558-4.....	23	HS-192.....	175	LIT-FLY-FLOW.....	252	MKT-POP-PF.....	253



**PART NUMBER INDEX cont'd**

MKT-POP-SCAP.....	253	PH-EF.....	203	PI374.....	103	PRO-GREEN-5.....	222	SC-1.....	80
MKT-POP-WS.....	253	PI203.....	107	PI375.....	103	PRO-GREEN-55.....	222	SC-10.....	74
MKT-POP-WSDEMO.....	252	PI206.....	107	PI377.....	104	PRO-KLEEN.....	223	SC-1WP.....	80
MKT-POSTER-CLRVUE.....	253	PI221.....	119	PI378.....	104	PRO-KLEEN-5.....	223	SC-25.....	74
MKT-POSTER-MSPLIT.....	253	PI222.....	119	PI379.....	104	PRO-KLEEN-55.....	223	SCAP-60D.....	137
MKT-SAM-ELEC.....	252	PI226.....	119	PI380.....	117	PRO-RED+.....	223	SCM-10.....	74
MKT-SAM-HSI.....	252	PI227.....	119	PI381.....	117	PRO-RED+32.....	223	SCM-25.....	74
ML-100.....	167	PI228.....	119	PI382.....	104	PRO-RED+5.....	223	SCM-5.....	74
MP-12.....	28	PI232.....	104	PI383.....	103	PRO-RED+55.....	223	SCM-PG-TEST.....	231
MP-12C.....	28	PI232CX.....	104	PI384.....	104	PRO-THAW.....	233	SH-06.....	83
MP-12E.....	28	PI237.....	119	PI385.....	104	PRO-THAW-1.....	233	SH-12.....	83
MP-18.....	28	PI301.....	107	PI385-34.....	104	PROTREAT-151.....	229	SOS-1.....	67
MP-18C.....	28	PI303.....	107	PI386.....	104	PROTREAT-152.....	229	ST-10.....	77
MP-18E.....	28	PI304.....	107	PI387.....	103	PROTREAT-161.....	230	ST-24.....	77
MP-2.....	28	PI305.....	107	PI388.....	103	PROTREAT-200.....	230	ST-4.....	77
MP-2C.....	28	PI305LX.....	107	PI389.....	104	PROTREAT-217.....	230	SUPERKOOL.....	228
MP-2E.....	28	PI306.....	107	PI389-GFI.....	104	PROTREAT-350.....	229	SUPERKOOL-16.....	228
MP-3.....	28	PI306CX.....	107	PI390.....	103	PRO-YELLOW.....	223	T-1.....	165
MP-3C.....	28	PI307.....	107	PI391.....	103	PRO-YELLOW-32.....	223	T-10.....	165
MP-3E.....	28	PI307CX.....	107	PI393.....	103	PRO-YELLOW-5.....	223	T-100.....	165
MP-4.....	28	PI308.....	107	PI394.....	103	PRO-YELLOW-55.....	223	T-101.....	165
MP-4C.....	28	PI309.....	107	PI411.....	105	PS-01.....	229	T-11.....	165
MP-4E.....	28	PI310.....	107	PI412.....	105	PS-03.....	229	T-12.....	165
MP-6.....	28	PI310LX.....	107	PI415.....	105	PS-07.....	229	T-13.....	165
MP-6C.....	28	PI311.....	105	PI416.....	105	PS-075.....	229	T-14.....	165
MP-6E.....	28	PI312.....	105	PI419.....	105	PS-1.....	227	T1401.....	142
MP-8.....	28	PI315.....	105	PI426.....	105	PS-20.....	229	T1404.....	142
MP-8C.....	28	PI316.....	107	PI431.....	105	PS-40.....	229	T-15.....	165
MSA-44.....	240	PI317.....	107	PI435.....	105	PW-16.....	186	T-16.....	165
MSA-45.....	240	PI318.....	105	PI440.....	105	PW-32.....	186	T-17.....	165
MSA-4545.....	240	PI319.....	105	PI458.....	105	PW-4.....	186	T-18.....	165
N20-SD.....	160	PI319CX.....	105	PI459.....	105	PW-8.....	186	T-20.....	165
PA10.....	151	PI320.....	105	PI908.....	107	PWB-16.....	186	T-200.....	166
PA18.....	151	PI321.....	105	PI908CX.....	107	PWB-4.....	186	T-21.....	165
PA25.....	151	PI322.....	105	PI909LX.....	107	PWB-8.....	186	T-23.....	165
PA25AP.....	151	PI325.....	105	PI911.....	107	PWH-16.....	186	T2401.....	142
PANPATCH.....	224	PI326.....	119	PI912.....	107	PWH-4.....	186	T2403.....	142
PANPATCH-32.....	224	PI327.....	119	PI912LX.....	107	PWH-8.....	186	T2404.....	142
PANPATCH-BAG.....	224	PI328.....	119	PI913.....	107	PWU-16.....	186	T-300.....	166
PC-600-B.....	36	PI330.....	107	PI913LX.....	107	PWU-4.....	186	T3401.....	142
PC-600-S.....	36	PI331.....	107	PI914.....	107	PWU-8.....	186	T3403.....	142
PC-609-B.....	36	PI332.....	107	PI929.....	119	Q0200TR.....	135	T3501.....	142
PC-609-S.....	36	PI335.....	111	PI930.....	119	QAV-2.....	191	T-400.....	166
PC-622-B.....	36	PI337-3.....	119	PK-2.....	179	QN-S3.....	69	T-408.....	166
PC-622-S.....	36	PI340.....	105	PK-2B.....	179	QT-1.....	241	T-409.....	166
PC-857.....	36	PI341.....	105	POE100-01.....	231	QT-100.....	241	T-411.....	166
PE-104.....	190	PI342.....	105	POE100-32.....	231	QT-100G.....	241	T-412.....	166
PF-08.....	225	PI344.....	107	POE32-01.....	231	QT-100N.....	241	T-417.....	166
PF-16.....	225	PI345.....	107	POE32-32.....	231	QT-2.....	241	T-418.....	166
PF-ADAPTER.....	225	PI346.....	107	POE68-01.....	231	QTH-1.....	241	T5401.....	142
PF-DEMO.....	252	PI350.....	105	POE68-32.....	231	QTH-2.....	241	T6752.....	142
PF-IGUN.....	225	PI351.....	105	PP-16.....	186	QTM-1.....	241	T6753.....	142
PF-IHOSE.....	225	PI352.....	105	PP-32.....	186	QTM-2.....	241	T7750.....	142
PF-KIT.....	225	PI353.....	105	PP-4.....	186	QTM-3.....	241	T7752.....	142
PG-100.....	225	PI355.....	105	PP-8.....	186	R-1.....	172	T7760.....	142
PG-100-5.....	225	PI360.....	103	PPC-16.....	186	RC-1.....	246	T-8.....	165
PG-100-55.....	225	PI360-3/4.....	103	PPC-32.....	186	RLF-8.....	224	T-9.....	165
PG-50.....	225	PI361.....	103	PPC-4.....	186	RM-10.....	83	TC-007.....	171
PG-50-5.....	225	PI361-3/4.....	103	PPC-8.....	186	RM-1G.....	83	TC-25.....	69
PG-50-55.....	225	PI362.....	103	PRO-BLUE.....	222	RS-15.....	175	TD-1.....	177
PG-AL.....	226	PI363.....	103	PRO-BLUE-32.....	222	RS-20.....	175	TD-2.....	177
PG-AL-5.....	226	PI364.....	103	PRO-BLUE-5.....	222	RS-31.....	175	TG-05.....	176
PG-AL-55.....	226	PI365.....	103	PRO-BLUE-55.....	222	RS-41.....	175	TG-10.....	69
PG-BG.....	226	PI366.....	103	PRO-BROWN.....	222	RS-9.....	175	TG-30.....	176
PG-BG-5.....	226	PI367.....	103	PRO-BROWN-32.....	222	RS-TS10.....	175	TG-30-1.....	176
PG-BG-55.....	226	PI368.....	104	PRO-BROWN-5.....	222	S-3.....	170	TG-30-12.....	176
PG-PLUS.....	225	PI369.....	104	PRO-BROWN-55.....	222	SANI-CND.....	224	TG-87A.....	69
PG-PLUS-5.....	225	PI370.....	104	PRO-BUBBLE-32.....	224	SANI-CND-32.....	224	TLC-3-10.....	151
PG-PLUS-55.....	225	PI371.....	104	PRO-GREEN.....	222	SANI-CND-5.....	224	TLC-3-12.....	151
PH-BF.....	203	PI373.....	103	PRO-GREEN-32.....	222	SANI-CND-55.....	224	TLC-3-8.....	151

## PART NUMBER INDEX cont'd

TRIPLE-D.....	222	UC3048-3.....	20	VST-44.....	240	W803-50.....	155	WT05C.....	157
TRIPLE-D-32.....	222	UC3132-3L.....	21	VT-24.....	240	W804.....	154	WT07.....	157
TRIPLE-D-5.....	222	UC3143-2.....	20	VT-4.....	240	W804-100.....	154	WT07C.....	157
TRIPLE-D-55.....	222	UC3232-2.....	20	VTR-24.....	240	W804-50.....	155	WT11.....	157
TRIPLE-D-AER.....	222	UC3232-3.....	20	VTS-10.....	240	W805.....	154	WT11C.....	157
TRIPLE-D-GRAN.....	222	UC3232-3CA.....	21	VTS-12.....	240	W805-100.....	154	WT15.....	157
TRIPLE-D-RTU.....	222	UC3234-2.....	20	VTS-14.....	240	W805-50.....	155	WT15C.....	157
TS-1.....	150	UC3237-2.....	20	VTS-18.....	240	WC02.....	157	WTA1.....	157
TS-3.....	150	UC3237-3.....	20	VTS-3-10.....	240	WC03.....	157	WTB05.....	157
TS-4.....	150	UC3434-2.....	20	VTS-3-12.....	240	WC04.....	157	WTB05C.....	157
TS-5.....	150	UC3434-3.....	20	VTS-3-14.....	240	WC05.....	157	WTB07.....	157
TT-120.....	171	UC3445-2.....	20	VTS-3-18.....	240	WC06.....	157	WTB07C.....	157
TT-24.....	171	UC3445-3.....	20	VTS-46.....	240	WC07.....	157	WTB07M.....	157
TT-240.....	171	UC3445-3CA.....	21	VTS-56.....	240	WC08.....	157	WTB11.....	157
U2660-3.....	20	UC3539-3L.....	21	VTS-68.....	240	WC09.....	157	WTB11C.....	157, 206
U3060-3.....	20	UC3636-2.....	20	VTS-810.....	240	WC10.....	157	WTB11CR.....	157
U3353-3.....	20	UC3636-3.....	20	VVC-1.....	240	WC12.....	157	WTB11D.....	157
U3465-3.....	20	UC3636-3CA.....	21	W101.....	154	WC14.....	157	WTB11M.....	157
U3650-3.....	20	UC3640-2.....	20	W101-100.....	154	WC16.....	157	WTB15.....	157
U3654-3.....	20	UC3642-3.....	20	W101-50.....	155	WCA1.....	157	WTB15C.....	157
U3660-3.....	20	UC3642-3CA.....	21	W102.....	154	WG840204.....	132	WTBA1.....	157
U3678-3.....	20	UC3648-2.....	20	W102-100.....	154	WG840204HT.....	132	WTM05.....	157
U3865-3.....	20	UC3648-3.....	20	W102-50.....	155	WG840205.....	132	WTM05C.....	157
U3870-3.....	20	UC3648-3CA.....	21	W103.....	154	WG840205HT.....	132	WTM07.....	157
U4054-3.....	20	UC3842-2.....	20	W103-100.....	154	WG840463.....	133	WTM07C.....	157
U4550-3.....	20	UC3842-3.....	20	W103-50.....	155	WG840464.....	133	WTM1.....	157
U4558-3.....	20	UC4040-2.....	20	W104.....	154	WG840465.....	133	WTM11.....	157
U4848-3.....	20	UC4040-3.....	20	W104-100.....	154	WG840466.....	133	WTM11C.....	157
U4854-3.....	20	UC4040-3CA.....	21	W104-50.....	155	WG840467.....	133	WTM14.....	157
U4866-3.....	20	UC4042-3.....	20	W105.....	154	WG840468.....	133	WTM14C.....	157
U5053-3.....	20	UC4044-3L.....	21	W105-100.....	154	WG840469.....	133	WTM1C.....	157
U5056-3.....	20	UC4147-2.....	20	W105-50.....	155	WG840583.....	132	WTM2.....	157
U5075-3.....	20	UC4347-3.....	20	W121.....	154	WG840584.....	132	WTM2C.....	157
U5079-3.....	20	UV-1.....	32	W121-100.....	154	WG840585.....	132	WTMB05.....	157
U5252-3.....	20	UV-BULB.....	32	W121-50.....	155	WG840586.....	132	WTMB05C.....	157
U5260-3.....	20	VA-3-346.....	240	W122.....	154	WG840587.....	132	WTMB07.....	157
U5557-3.....	20	VA-34.....	240	W122-100.....	154	WG840588.....	132	WTMB07C.....	157
U6067-3.....	20	VA-46.....	240	W122-50.....	155	WG840589.....	132	WTMB11.....	157
UA-1.....	67	VA-68.....	240	W123.....	154	WG840590.....	132	WTMB11C.....	157
UC1636-2.....	20	VAU-24.....	240	W123-100.....	154	WG840595.....	132	WTMB14.....	157
UC1636-3.....	20	VAU-45.....	240	W123-50.....	155	WG840596.....	132	WTMB14C.....	157
UC1838-3.....	20	VAX-2.....	240	W124.....	154	WG840727.....	132	X2424211.....	24
UC1838-3CA.....	21	VAX-3.....	240	W124-100.....	154	WG840728.....	132	X2424311.....	24
UC2424-2.....	20	VAX-4.....	240	W124-50.....	155	WG840728HT.....	132	X2430211.....	24
UC2424-3.....	20	VAX-5.....	240	W125.....	154	WG840729.....	132	X2436211.....	24
UC2424-3CA.....	21	VAX-6.....	240	W125-100.....	154	WG840729HT.....	132	X2436311.....	24
UC2430-2.....	20	VAX-8.....	240	W125-50.....	155	WG840730.....	132	X3030211.....	24
UC2430-3.....	20	VC-4.....	240	W141.....	154	WG840730HT.....	132	X3030311.....	24
UC2436-2.....	20	VC-4R.....	240	W141-100.....	154	WG840731.....	132	X3232211.....	24
UC2436-3.....	20	VCC-4.....	240	W141-50.....	155	WG840731HT.....	132	X3232311.....	24
UC2436-3CA.....	21	VCC-4B.....	240	W142.....	154	WG840736HT.....	132	X3244211.....	24
UC2442-3.....	20	VCR-1.....	241	W142-100.....	154	WG840737HT.....	132	X3636211.....	24
UC2448-2.....	20	VCRT-1.....	241	W142-50.....	155	WG840738HT.....	132	X3636311.....	24
UC2448-3.....	20	VCRT-1R.....	241	W143.....	154	WG840739HT.....	132	X3830211.....	24
UC2448-3CA.....	21	VCRT-1RK.....	241	W143-100.....	154	WHT20.....	155	X3836211.....	24
UC2626-2.....	20	VCRT-1S.....	241	W143-50.....	155	WHTB10-20.....	155	X3842211.....	24
UC2626-3.....	20	VE-2.....	240	W144.....	154	WHTB10-50.....	155	X3848311.....	24
UC2628-2.....	20	VLC-10.....	241	W144-100.....	154	WHTB12-20.....	155	X5055301.....	24
UC2636-3.....	20	VLC-12.....	241	W144-50.....	155	WHTB12-50.....	155		
UC2636-3CA.....	21	VLC-18.....	241	W145.....	154	WHTB14-50.....	155		
UC2838-3.....	20	VLC-25.....	241	W145-100.....	154	WHTR14-50.....	155		
UC3030-2.....	20	VLC-4.....	241	W145-50.....	155	WHTW14-50.....	155		
UC3030-3.....	20	VLC-5.....	241	W801.....	154	WM1002.....	119		
UC3030-3CA.....	21	VLC-6.....	241	W801-100.....	154	WM1003.....	119		
UC3036-2.....	20	VLC-8.....	241	W801-50.....	155	WM1009.....	119		
UC3036-3.....	20	VP68-01.....	232	W802.....	154	WM1014.....	119		
UC3036-3CA.....	21	VP68-05.....	232	W802-100.....	154	WS-1.....	67		
UC3040-2.....	20	VP68-32.....	232	W802-50.....	155	WTO4.....	157		
UC3040-3.....	20	VS-4.....	240	W803.....	154	WTO4C.....	157		
UC3040-3CA.....	21	VST-4.....	240	W803-100.....	154	WTO5.....	157		

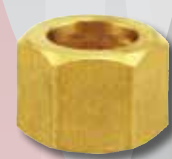
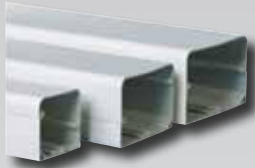
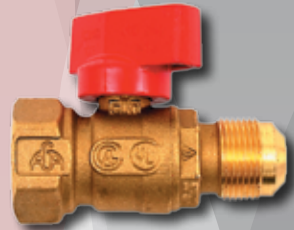

# ABOUT DIVERSITECH

DiversiTech is North America's largest manufacturer of air conditioning condenser pads and a leading supplier of components and related products for the heating, ventilating, air conditioning, and refrigeration (HVACR) industry.

Headquartered in Atlanta, Georgia, DiversiTech manufactures a suite of products, which includes a wide range of mechanical, electrical, chemical, and structural parts for HVACR and electrical systems, and swimming pool installations. The company maintains manufacturing and distribution facilities in key U.S. locations, Europe, and in the Far East. DiversiTech has enjoyed a continued history of successful growth and has acquired industry-recognized brand names including Rehvac, Devco® Enterprises, Wagner® Manufacturing, The Black Pad®, Hef-T-Pad™ and Specialty Chemical.

- PADS
- AIR MOVEMENT
- HEATING PRODUCTS
- CONDENSATE MANAGEMENT
- GENERAL INDUSTRIAL
- DEVCO
- ELECTRICAL
- TOOLS
- PLUMBING
- DUCTLESS SYSTEMS
- MAINTENANCE CHEMICALS
- INLINE COMPONENTS

DOWNLOAD <http://media.diversitech.com/doc/DOC32509.pdf>

CORRECTIONS/COMMENTS [feedback@diversitech.com](mailto:feedback@diversitech.com)



LIT-CAT-HVAC  
6650 Sugarloaf Parkway  
Duluth, GA 30097  
678.542.3600  
800.995.2222  
678.542.3700 Fax  
[www.diversitech.com](http://www.diversitech.com)  
©2013 DiversiTech Corporation

