

- ALL STEEL CONSTRUCTION
- FIXED BARS ON 3/4 INCH CENTERS SET AT 35°
- MINIMUM SIZE: 6 X 4
- MAXIMUM SIZE: 48 X 36 ONE PIECE CONSTRUCTION
- AVAILABLE IN 2 INCH INCREMENTS
- FINISH: WHITE (W) ENAMEL

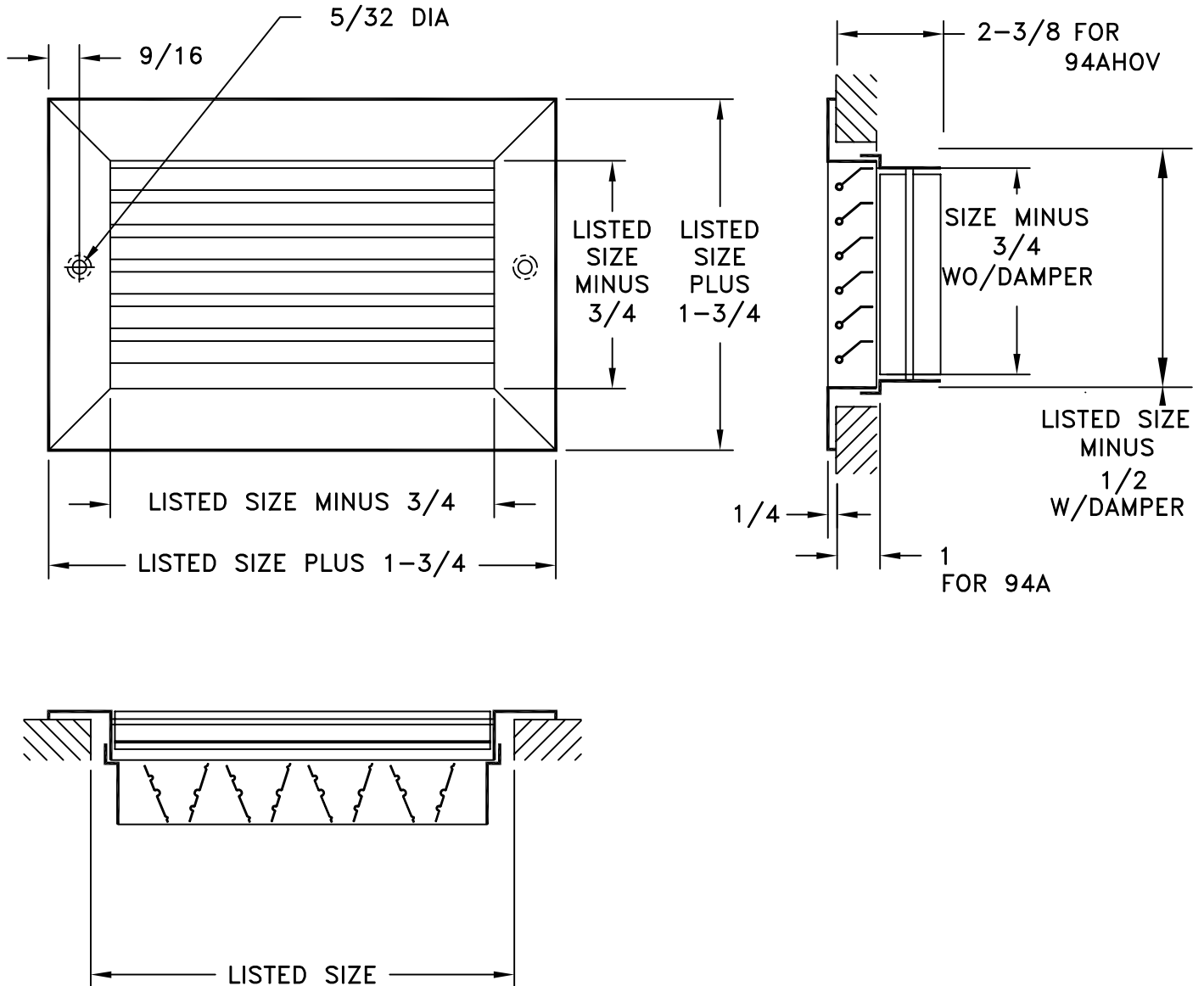

JOB NAME: _____	SUBMITTED BY: _____	DATE: 04/15/2014	SD-9011
LOCATION: _____		94A, 94AHOV	
ARCHITECT: _____		Fixed Steel Horizontal	
ENGINEER: _____		Bar Return Grille	
CONTRACTOR: _____			