

Fastener Tools & Accessories



Mighty-Right™

Right Angle Impact Driver

Smallest, lightest, most maneuverable impact driver on earth!

New!
in 2011



Use the Mighty-Right™ to drive or remove sheet metal screws in tight spaces and blind spots encountered when installing metal duct work, including access into small diffuse boxes and equipment enclosures.

A unique LED light integrated into bit area sight line features a separate on / off switch.



An external belt-clip mounted battery pack stays clear of work and won't weigh down or unbalance this one hand tool operation.

With a fully charged battery, the Mighty-Right™ is capable of delivering 140 in.-lbs. maximum torque to quickly seat sheet metal screws in steel up to 16 ga. (1/16" or 1.6 mm)

The 5-foot (1.5 m) battery cable provides generous reach.



Quick-connect jacks with positive locking tabs won't pull out.



Ergonomic contours and a non-slip gripping area ensure easy one-hand operation.



A handy knockout hole permits easy removal of a lodged bit. The hex socket drive shaft accepts any 1/4" hex shank bit.

Specifications

Catalog Number	Description	Driver Length in. (mm)	Driver Weight lbs. (kg)	Battery Weight lbs. (kg)	Charger Accepted
MR1	Right Angle Impact Driver Kit	7 (178)	1.1 (0.5)	.5 (0.23)	Li-ion

Replacement Kit Components

MR11	5 ft. (1.5 m) Battery Cable
MR12	One-Hour, Li-ion Recharger
MR13	7.2V, 1.5Ah Li-ion Battery Pack
MR14	Low Profile 1/4" and 5/16" Hex Bits
MR15	#1 and #2 Robertson Square Bits



No. MR1- Right Angle Impact Driver Kit

Kit includes: two belt-clip-mount, lithium battery packs; a long-reach battery cable and a 1-hour recharger in an HDPE (high density polyethylene) storage case.



Four low profile power bits are also supplied with kit: 1/4" and 5/16" Magnetic Hex bits and #1 and #2 Robertson square bits.

MR1

2-in-1

Hand Riveter

One hand operation with normal squeezing action provides enough pulling power to set all popular size rivets

(see specifications column below). 2-in-1 adjustment features a single long stroke for most hand riveting applications and a short "ratchet action" power stroke for setting larger diameter rivets. Outside jaw-grip adjustment wheel opens and closes jaws with fingertip ease to fit any size mandrel and to obtain maximum stroke efficiency. Professional slim nose allows 2-in-1 to go where other hand riveters cannot. Ideal for reaching into corners and recessed areas. Three nosepieces 1/8", 5/32" and 3/16" included with tool. Nosepieces are stored in handle. Heavy duty all steel construction insures long life and minimum wear. Polished finish, nickel-chrome plated. Red vinyl cushion grip and hand stop.



LONG STROKE
Bolt in upper hole for easy pulling rivets in one pull.



SHORT "RATCHET ACTION" POWER STROKE
Bolt in lower hole for hard pulling rivets in several easy pulls.



Economy Hand Riveter

Lightweight, compact size and slim nose projection allows this riveter to go wherever the work is.

Four rivet nosepieces: 3/32", 1/8", 5/32", 3/16" store in handle. Ideally suited for blind riveting applications in aluminum windows, gutter and downspout. Not for use with 5/32" or 3/16" steel rivets (steel rivets larger than 3.2 mm). Spring return handles and comfortable contour grip make operation fast and easy. Just open handles and insert rivet into tool until flange touches nosepiece. Squeeze handles slightly to allow jaws to grip rivet mandrel. Insert rivet into pre-drilled work to be fastened and squeeze handles until mandrel snaps. Release grip on handles and mandrel will drop out front end of tool when tilted.

Rugged steel construction with black paint finish and comfortable vinyl grip. Secure handle latch makes this tool easy to fit in pouch or pocket.



Specifications

Catalog Number	Description	Capacities in. (mm)	Length in. (mm)	Net Wt. oz. (g)
2-in1	2-in-1 Hand Riveter	3/32 thru- 3/16 (2.4 - 4.8) steel rivets / 3/32 thru- 5/32 (2.4 - 4.0) stainless steel rivets	8 (203)	20 (567)
CR18	Economy Hand Riveter	3/32 thru 1/8 (2.4 - 3.2) steel rivets	8 (203)	22 (624)

Replacement Accessories and Parts for 2-in-1 Hand Riveter

ER41	Jaws
ER44	3/16" nosepiece
ER45	1/8" nosepiece
ER46	5/32" nosepiece
HR3-7	Adjustment Rod assembly

Jobber Drill Sets



FJ13S
13 Piece Set



FJ60S
60 Piece
Wire Gauge Set

Orifice Drill Set



FJ6180
20 Piece
Orifice Drill Set
includes: PV1 Pin Vise

PV1

Use in hand or insert in drill chuck.
Pin Vise holds wire gauge drill sizes 60 to 97.

High Speed Jobber Length Drills



General purpose drills. 118° conventional point angle allows deep drilling in a variety of materials including metal.

Sheet Metal Drills



Sheet metal drills with 135° split point design bite into metal precisely where wanted - will not wander.

Double Ender Sheet Metal Drills



Two Points for twice the life, twice the convenience!
Available in Bulk Packs!

Specifications

Catalog Number	Description	Set Contents	Capacity	Length in.
FJ13S	13 Piece Jobber Drill Set	Fractional sizes in metal DRILDEX container Sizes: 1/16 to 1/4" x 64ths		
FJ60S	60 Piece Jobber Wire Gauge Set	Wire gauge sizes in metal DRILDEX container Sizes: 1 to 60		
FJ6180	20 Piece Orifice Drill Set	Wire gauges sizes for drilling or cleaning oil and gas orifices. Metal DRILDEX container. Sizes: 61 to 80. Includes pin vise.		
PV1	Pin Vise	—	Ga. sizes 60-97	3"

High Speed Jobber Length Drills (Fractional Sizes)

Catalog Number	Description	Decimal Equivalent in.	Length Overall in.	Length of Twist in.	Package Size
FJ1/8	High Speed Jobber Length Drill Bit	.1250	2-3/4	—	—
FJ3/16	High Speed Jobber Length Drill Bit	.1875	3-1/2	—	—
FJ1/4	High Speed Jobber Length Drill Bit	.2500	4	—	—
FJ5/16	High Speed Jobber Length Drill Bit	.3125	4-1/2	—	—
FJ3/8	High Speed Jobber Length Drill Bit	.3750	5	—	—
FJ1/2	High Speed Jobber Length Drill Bit	.5000	6	—	—

Sheet Metal Drills (Fractional Sizes)

FS1/8	Sheet Metal Drill Bit	.1250	1-7/8	—	1
FS3/16	Sheet Metal Drill Bi	.1875	2-3/16	—	1
FS1/4	Sheet Metal Drill Bit	.2500	2-1/2	—	1
FS3/8	Sheet Metal Drill Bit <i>(FS Series with 1/4" reduced Shank)</i>	.3750	3-1/8	—	1
FS1/2	Sheet Metal Drill Bit <i>(FS Series with 1/4" reduced Shank)</i>	.5000	3-3/4	—	1
PFS1/8	Sheet Metal Drill Bit <i>(Polished)</i>	.1250	1-7/8	—	12
PFS30	Sheet Metal Drill Bit <i>(Polished)</i>	.1285	1-15/16	—	12
PFS1/4	Sheet Metal Drill Bit <i>(Polished)</i>	.2500	2-1/2	—	12

Double Ender Sheet Metal Drills

DE1/8	Double Ender Sheet Metal Drill Bit <i>(Polished)</i>	.1250	2	1/2	12
DE1/8B	Bulk Pack Double Ender Sheet Metal Drill Bits <i>(Polished)</i>	.1250	2	1/2	144
DE30	Double Ender Sheet Metal Drill Bit <i>(Polished)</i>	.1285	2	1/2	12
DE30B	Bulk Pack Double Ender Sheet Metal Drill Bits <i>(Polished)</i>	.1285	2	1/2	144
DE9/64	Double Ender Sheet Metal Drill Bit <i>(Polished)</i>	.1406	1-15/16	1/2	12
DE3/16	Double Ender Sheet Metal Drill Bit <i>(Polished)</i>	.1875	2-3/16	1/2	12
DE1/4	Double Ender Sheet Metal Drill Bit <i>(Polished)</i>	.2500	2-1/2	1/2	12
NDE1/8	Double Ender Sheet Metal Drill Bit <i>(Black Nitrided)</i>	.1250	2	1/2	12
NDE30	Double Ender Sheet Metal Drill Bit <i>(Black Nitrided)</i>	.1285	2	1/2	12

Step Drills

A unique double flute design assures the penetration of soft or thin materials at the proper speed. Drill hole sizes from 1/8" to 1" in sheet metal without burring or deforming stock or threading drill bit.

Malco Step Drills actually deburr as they drill. Perfect for use as a "hole-opening" reamer. They can also be used for making round holes from slots or intersecting holes. Made of industrial grade high speed steel. Malco Step Drills are heat treated and tempered to assure maximum strength for long wearing rugged use. Completely resharpenable.



UB1

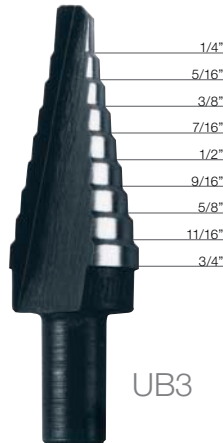

UB3



UB11



UB20

Spade Wood Type Bits

Unique designed ground points and cutting edges drill faster, cleaner holes, using less power than standard spade type bits. Cut straight or angled holes in soft and hard woods, plus formica, plaster, chipboard, foam core material, many non-metallic building sidings and foam insulation. Made of one-piece special heat treated tool grade steel. Six "flat" 1/4" shank fits securely in conventional chucks. Easy to spot "size marking" is stamped on head. Bits also feature "head hole" for convenient storage and wire pulling. Resharpenable with saw file or grinder. Available individually or in sets.

WBSK
Wood Bit Kit

Carbide Tipped Rotary-Percussion Bits



Use in any rotary or rotary percussion drilling device for unexcelled performance in brick, tile, granite, concrete, masonry and other similar hard and dense materials. Brazed tungsten carbide tips have 120° chamfer and are specially tempered for strength and long life.

Specifications

Catalog Number	Description	Depth Each Step	Elect. Drill Size	Pilot Hole Required
UB1	Drills 13 hole sizes from 1/8" to 1/2" diameter in 1/32" (0.79) increments.	1/8"	1/4"	No
UB3	Drills 9 hole sizes from 1/4" to 3/4" diameter in 1/16" increments.	1/8"	3/8"	No
UB11	Drills 11 hole sizes from 1/4" to 7/8" diameter for creating 1/2" knock outs.	N/A	3/8"	No
UB20	Drills 8 hole sizes from 9/16" to 1" diameter in 1/16" increments.	1/8"	3/8"	1/2"

Spade Type Wood Bits

Catalog Number	Description	Overall Length	Diameter	Shank Diameter
WB38	Spade Type Wood Bit	—	3/8"	—
WB12	Spade Type Wood Bit	—	1/2"	—
WB58	Spade Type Wood Bit	—	5/8"	—
WB34	Spade Type Wood Bit	—	3/4"	—
WB78	Spade Type Wood Bit	—	7/8"	—
WB1	Spade Type Wood Bit	—	1"	—
WB118	Spade Type Wood Bit	—	1-1/8"	—
WB114	Spade Type Wood Bit	—	1-1/4"	—
WB138	Spade Type Wood Bit	—	1-3/8"	—
WB112	Spade Type Wood Bit	—	1-1/2"	—
WB6K	6 piece set: 3/8", 1/2", 5/8", 3/4", 7/8" and 1"	—	—	—

Carbide Tipped Rotary-Percussion Bits

Catalog Number	Description	Nominal Overall Length	Bit Diameter	Shank Diameter
RP01	Carbide Tipped Rotary Percussion Bit	3"	1/8"	1/8"
RP04	Carbide Tipped Rotary Percussion Bit	3-5/16"	3/16"	3/16"
RP09	Carbide Tipped Rotary Percussion Bit	4"	1/4"	1/4"
RP10	Carbide Tipped Rotary Percussion Bit	6"	1/4"	1/4"
RP18	Carbide Tipped Rotary Percussion Bit	4-3/4"	5/16"	5/16"
RP46	Carbide Tipped Rotary Percussion Bit	6"	1/2"	3/8"

Regular and Gripped

Screwdrivers

Regular Gripped Screwdrivers

Shallow fluted handles with large end bearing surface provide a sure, comfortable grip for maximum torque.



Easy to Spot Orange Handle

Precision Ground tip for perfect screw fit.

Cushioned Gripped Screwdrivers

The same great features as all Malco drivers plus a large, comfortable barrel shaped cushion grip.



Large comfortable barrel shaped custom grip.

Designed for maintenance, electrical and assembly continuous use applications.

Keystone and Phillips drivers are also ideal for driving hardened screw heads in sheet metal. Individually heat treated blade tips are precision ground for perfect fit in screw head. Handles are shockproof and shatterproof. Driver handles and blades are joined securely and will not turn or come loose. Driver construction assures many years of reliable, superior performance.

Square Shank Keystone



S56

S56C

Round Shank Keystone



K41

K44C

Electrical / Cabinet Style



C22

C33C

Electrical Style

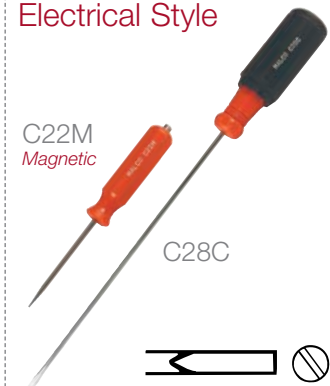

C22M
Magnetic

C28C

Specifications

Regular Grip Screwdrivers

Catalog Number	Description	Blade Diameter in. (mm)	Blade Length in. (mm)	Recomm. Screw #
S44	Square Shank	1/4 (6.4)	4 (102)	10-12
S56	Square Shank	5/16 (7.9)	6 (152)	12-16
S68	Square Shank	3/8 (9.5)	8 (203)	16-20
S612	Square Shank	3/8 (9.5)	12 (305)	16-20
K44	Round Shank Keystone	1/4 (6.4)	4 (102)	10-12
K56	Round Shank Keystone	5/16 (7.9)	6 (152)	12-16
K68	Round Shank Keystone	3/8 (9.5)	8 (203)	16-20
C22	Electrical / Cabinet Style	1/8 (3.2)	2 (51)	2-5
C22M	Electrical Style	1/8 (3.2)	2 (51)	2-5

Cushioned Grip Screwdrivers

Catalog Number	Description	Blade Diameter in. (mm)	Blade Length in. (mm)	Recomm. Screw #
S44C	Square Shank (Gripped)	1/4 (6.4)	4 (102)	10-12
S56C	Square Shank (Gripped)	5/16 (7.9)	6 (152)	12-16
S68C	Square Shank (Gripped)	3/8 (9.5)	8 (203)	16-20
K41C	Round Shank Keystone (Gripped)	1/4 (6.4)	1-1/2 (38)	10-12
K44C	Round Shank Keystone (Gripped)	1/4 (6.4)	4 (102)	10-12
K56C	Round Shank Keystone (Gripped)	5/16 (7.9)	6 (152)	12-16
K68C	Round Shank Keystone (Gripped)	3/8 (9.5)	8 (203)	16-20
C33C	Electrical / Cabinet Style (Gripped)	3/16 (4.8)	3 (76)	6-9
C36C	Electrical / Cabinet Style (Gripped)	3/16 (4.8)	6 (152)	6-9
C45C	Electrical / Cabinet Style (Gripped)	1/4 (6.4)	5 (127)	10-12
C24C	Electrical Style (Gripped)	1/8 (3.2)	4 (102)	2-5
C26C	Electrical Style (Gripped)	1/8 (3.2)	6 (152)	2-5
C28C	Electrical Style (Gripped)	1/8 (3.2)	8 (203)	2-5

Regular / Gripped and Reversible Screwdrivers



7 Piece Combination Screwdriver Set

Gripped

Most popular sizes

of Keystone, Cabinet Style and Phillips screwdrivers packaged in a vinyl see-thru pouch.

SK2C

Phillips Head

High Polish Finish

P42C



P33



P33C

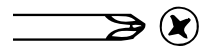

6 in 1 Reversible Driver

2 combination bits and 2 hex barrel openings
drive 6 different head styles / sizes.

Bit shank firmly locks into handle barrel. Driver bits are individually protected with black oxide. Barrel is chrome plated to protect against rust.



#2 Phillips



9/32"
Slotted
Head

#1 Phillips



3/16"
Slotted
Head

1/4"
Hex opening



5/16"
Hex opening

Durable
Black Oxide
Handle

RD6

Specifications

Regular Grip Screwdrivers

Catalog Number	Description	Blade Diameter in. (mm)	Blade Length in. (mm)	Recomm. Screw #
P44	Phillips Head	1/4 (6.4)	4 (102)	No. 2
P56	Phillips Head	5/16 (7.9)	6 (152)	No. 3

6 in 1 Reversible Driver

Catalog Number	Description
RD6	Driver with 2 combination bits and 2 hex barrel openings

Cushioned Grip Screwdrivers

Catalog Number	Description	Blade Diameter in. (mm)	Blade Length in. (mm)	Recomm. Screw #
P33C	Phillips Head (<i>Gripped</i>)	3/16 (4.8)	3 (76)	No. 1
P42C	Phillips Head (<i>Gripped</i>)	1/4 (6.4)	1-1/2 (38)	No. 2
P44C	Phillips Head (<i>Gripped</i>)	1/4 (6.4)	4 (102)	No. 2
P56C	Phillips Head (<i>Gripped</i>)	5/16 (7.9)	6 (152)	No. 3
SK2C	7 Piece Combination Screwdriver Set (<i>Gripped</i>)—Kit contains following:			
K41C	Round Shank Keystone (<i>Gripped</i>)	1/4 (6.4)	1-1/2 (38)	10-12
K44C	Round Shank Keystone (<i>Gripped</i>)	1/4 (6.4)	4 (102)	10-12
K56C	Round Shank Keystone (<i>Gripped</i>)	5/16 (7.9)	6 (152)	12-16
C24C	Electrical Style (<i>Gripped</i>)	1/8 (3.2)	4 (102)	2-5
C33C	Electrical / Cabinet Style (<i>Gripped</i>)	3/16 (4.8)	3 (76)	6-9
P33C	Phillips Head (<i>Gripped</i>)	3/16 (4.8)	3 (76)	No. 1
P44C	Phillips Head (<i>Gripped</i>)	1/4 (6.4)	4 (102)	No. 2

Magnetic Screwdrivers

Magnetized tips hold screws for easier installation in tight quarters when fastening inside profiles, around existing installations or reaching into cabinet enclosures.

Hardened chrome-vanadium steel blades offer maximum torque capacity. Cushioned handles offer a firm, ergonomically correct grip. And a handy hex-shaped base on selected round shank blades can be used with a wrench for added leverage. Satin chrome coating on blade shafts resists corrosion and a strong handle-to-shaft connection assures long service life.

Square Shank Keystone



Round Shank Keystone



Electric / Cabinet Style



Phillips Head



Specifications

Square Shank Keystone Screwdrivers

Catalog Number	Description	Blade Diameter in. (mm)	Blade Length in. (mm)	Recomm. Screw #
MS44C	Square Shank Keystone (Cushioned)	1/4 (6.4)	4 (102)	10-12
MS56C	Square Shank Keystone (Cushioned)	5/16 (7.9)	6 (152)	12-16
MS68C	Square Shank Keystone (Cushioned)	3/8 (9.5)	8 (203)	16-20

Round Shank Keystone Screwdrivers

Catalog Number	Description	Blade Dia. in. (mm)	Blade Lgth. in. (mm)	Recomm. Screw #	Hex. Base
MK41C	Round Shank Keystone (Cushioned)	1/4 (6.4)	1-1/2 (38.1)	10-12	Yes
MK44C	Round Shank Keystone (Cushioned)	1/4 (6.4)	4 (102)	10-12	Yes
MK56C	Round Shank Keystone (Cushioned)	5/16 (7.9)	6 (152)	12-16	Yes
MK68C	Round Shank Keystone (Cushioned)	3/8 (9.5)	8 (203)	16-20	Yes

Electrical / Cabinet Style Screwdrivers

Catalog Number	Description	Blade Dia. in. (mm)	Blade Lgth. in. (mm)	Recomm. Screw #	Hex. Base
MC22C	Electric / Cabinet Style (Cushioned)	1/8 (3.2)	2 (51)	2-5	—
MC24C	Electric / Cabinet Style (Cushioned)	1/8 (3.2)	4 (102)	2-5	—
MC33C	Electric / Cabinet Style (Cushioned)	3/16 (4.8)	3 (76)	6-9	Yes
MC36C	Electric / Cabinet Style (Cushioned)	3/16 (4.8)	6 (152)	6-9	Yes
MC45C	Electric / Cabinet Style (Cushioned)	1/4 (6.4)	5 (127)	10-12	Yes

Phillips Head Screwdrivers

Catalog Number	Description	Blade Dia. in. (mm)	Blade Lgth. in. (mm)	Recomm. Screw #	Hex. Base
MP33C	Phillips Head (Cushioned)	3/16 (4.8)	3 (76)	No. 1	Yes
MP44C	Phillips Head (Cushioned)	1/4 (6.4)	4 (102)	No. 2	Yes

Connectivity re-designed

Introducing New and Improved Malco Nut Drivers and Hex Drivers with CONNEXT™ Quick-Change Handles!

CONNEXT™ Handles from Malco have been combined with precision-fit and hardened Malco Chuck Driver components to offer the ultimate in Nut Driver and Hex Driver durability and versatility.



All components, including Magnetic Hex Chuck Drivers and all-new Hollow Hex Chuck Drivers and CONNEXT™ Handles are also available separately. Replacing a worn hex driver or nut driver with just a handle or driver shaft at a time is more economical. And changing a hand-held magnetic hex driver or hollow nut driver size can be as easy and thrifty as retrieving a different size chuck driver from your tool box.



Full or Stubby Grips →

Quick Connect Holder

Color Coded for easy size recognition

Durable

Malco Chuck Driver components meet on-the-job demands for performance and service life.

Versatile

CONNEXT™ Quick-Change Handles are equipped with a quick-connect holder mechanism to accept any 1/4-inch shank chuck driver.

Quick-Change

Handles

come in full grip and stubby sizes and are equipped with a quick-connect holder mechanism to accept any 1/4-inch shank chuck driver.

Hollow Hex Chuck Drivers with 1/4-inch power insert shanks, are available in 3-inch and big 6-inch lengths. And all Malco Hex Chuck drivers are now COLOR CODED for easy size identification whether installed on a power drill or used with a CONNEXT™ Handle.



Hollow Nut Drivers

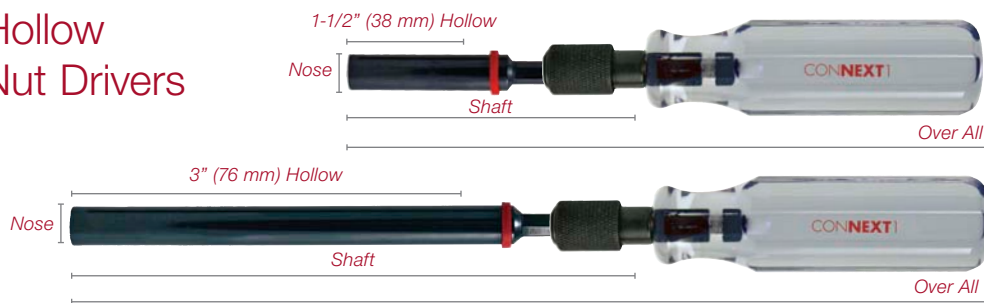

Note: Packaged Complete
Handles & Chuck Drivers are pre-assembled and packaged as one product on this page.

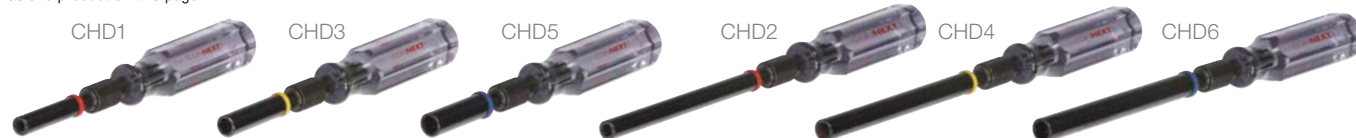

Magnetic Hex Hand Drivers



Specifications

CONNEXT™ Hollow Nut Drivers

Catalog Number	Description	Color Coded	Hex Opening in.	Hollow Depth in. (mm)	Insert Dia. in. (mm)	Nose Dia. in. (mm)	Holder Dia. in. (mm)	Shaft Total Lgth. in. (mm)	O/A Lgth. in. (cm)	Shaft Replacement #
CHD1	Connex™ Hollow Nut Driver	●	1/4"	1-1/2" (38)	1/4" (6)	7/16" (11)	11/16" (18)	3-3/8" (86)	7-1/2" (19)	HD1
CHD2	Connex™ Hollow Nut Driver	●	1/4"	3" (76)	1/4" (6)	7/16" (11)	11/16" (18)	6-7/8" (175)	10-1/2" (27)	HD2
CHD3	Connex™ Hollow Nut Driver	●	5/16"	1-1/2" (38)	1/4" (6)	1/2" (13)	11/16" (18)	3-3/8" (86)	7-1/2" (19)	HD3
CHD4	Connex™ Hollow Nut Driver	●	5/16"	3" (76)	1/4" (6)	1/2" (13)	11/16" (18)	6-7/8" (175)	10-1/2" (27)	HD4
CHD5	Connex™ Hollow Nut Driver	●	3/8"	1-1/2" (38)	1/4" (6)	9/16" (14)	11/16" (18)	3-3/8" (86)	7-1/2" (19)	HD5
CHD6	Connex™ Hollow Nut Driver	●	3/8"	3" (76)	1/4" (6)	9/16" (14)	11/16" (18)	6-7/8" (175)	10-1/2" (27)	HD6

CONNEXT™ Magnetic Long Hand Drivers

Catalog Number	Description	Color Coded	Reaction	Hex Opening in.	Insert Dia. in. (mm)	Nose Dia. in. (mm)	Holder Dia. in. (mm)	Shaft Total Lgth. in. (mm)	O/A Lgth. in. (cm)	Shaft Replacement #
HHD1	Connex™ Long Hand Driver	●	Magnetic	1/4"	1/4" (6)	7/16" (11)	11/16" (18)	6-7/8" (175)	10-1/2" (27)	MSHXL14
HHD2	Connex™ Long Hand Driver	●	Magnetic	5/16"	1/4" (6)	1/2" (13)	11/16" (18)	6-7/8" (175)	10-1/2" (27)	MSHXL516
HHD3	Connex™ Long Hand Driver	●	Magnetic	3/8"	1/4" (6)	9/16" (14)	11/16" (18)	6-7/8" (175)	10-1/2" (27)	MSHXL38

CONNEXT™ Magnetic Standard Length Hand Drivers

HHD1S	Connex™ Standard Lgth. Hand Driver	●	Magnetic	1/4"	1/4" (6)	7/16" (11)	11/16" (18)	3" (76)	7-1/8" (18)	MSHL14
HHD2S	Connex™ Standard Lgth. Hand Driver	●	Magnetic	5/16"	1/4" (6)	1/2" (13)	11/16" (18)	3" (76)	7-1/8" (18)	MSHL516
HHD3S	Connex™ Standard Lgth. Hand Driver	●	Magnetic	3/8"	1/4" (6)	9/16" (14)	11/16" (18)	3" (76)	7-1/8" (18)	MSHL38

CONNEXT™ Magnetic Stubby Hand Drivers

HHD1T	Connex™ Stubby Hand Driver	●	Magnetic	1/4"	1/4" (6)	7/16" (11)	11/16" (18)	2-1/4" (57)	4-1/8" (10)	MSH14
HHD2T	Connex™ Stubby Hand Driver	●	Magnetic	5/16"	1/4" (6)	1/2" (13)	11/16" (18)	2-1/4" (57)	4-1/8" (10)	MSH516
HHD3T	Connex™ Stubby Hand Driver	●	Magnetic	3/8"	1/4" (6)	9/16" (14)	11/16" (18)	2-1/4" (57)	4-1/8" (10)	MSH38



Hollow Hex Chuck Drivers

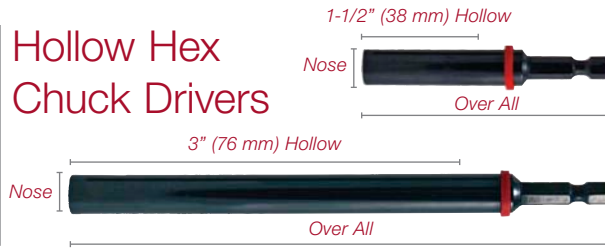

Use with all
corded or cordless drills &
Connex handles!



CONNEXT™ Quick Change Handles

Clear, molded acetate GRIPS are shock-proof, shatter-proof and fluted to fit any hand.



Magnetic Hex Chuck Drivers



Available in
Tubs and Boxes



Magnetic Hex Drivers
1/4 and 5/16 sizes also
available in bulk tubs of 100.



Magnetic Hex Drivers
Long Style
1/4 and 5/16 sizes also
available in bulk tubs of 50.



Magnetic Hex Drivers
Extra Long Style
1/4 and 5/16 sizes also
available in bulk boxes of 50.

1/4" Hex Shank
Phillips Power Bits
and Standard Bits



Magnetic Bit Holder for
1/4" Hex Shank Insert Bits



Quick Change Hex Adapter

Accepts 1/4" hex power bits.
Installs into chuck of a standard
3/8" power drill. Hex power bits
can then be inserted or removed
instantly without a key, by retracting
the adapter sleeve. Tempered
steel. Black finish.



Power Bit Extensions

Ball Bearing Lock
Big 6" and 10" lengths

BHE6
BHE10

Accepts 1/4" hex power bits. Ball Bearing on holder provides a positive lock on 1/4" hex shank power bits. Tempered steel.

Specifications

CONNEXT™ Quick-Change Handles

Catalog Number	Description	Grip Dia. in. (mm)	Grip Lgth. in.	Holder Opening in.	Holder Dia. in. (mm)	Holder Lgth. in. (mm)	O/A Lgth. in. (cm)
Connex1	Connex1™ Quick-Change Handle	1-1/8" (29)	4-1/8" (105)	1/4"	11/16" (18)	1-1/8" (29)	5-1/4" (133)
Connex2	Connex2™ Quick-Change Handle	1-1/8" (29)	1-7/8" (48)	1/4"	11/16" (18)	1-1/8" (29)	3-1/8" (79)

CONNEXT™ Hollow Hex Chuck Drivers

Catalog Number	Color Coded	Hex Opening in.	Hollow Depth in. (mm)	Insert Dia. in. (mm)	Nose Dia. in. (mm)	O/A Lgth. in. (cm)
HD1	Red	1/4"	1-1/2" (38)	1/4" (6)	7/16" (11)	3" (76)
HD2	Red	1/4"	3" (76)	1/4" (6)	7/16" (11)	6" (152)
HD3	Yellow	5/16"	1-1/2" (38)	1/4" (6)	1/2" (13)	3" (76)
HD4	Yellow	5/16"	3" (76)	1/4" (6)	1/2" (13)	6" (152)
HD5	Blue	3/8"	1-1/2" (38)	1/4" (6)	9/16" (14)	3" (76)
HD6	Blue	3/8"	3" (76)	1/4" (6)	9/16" (14)	6" (152)

CONNEXT™ Long Chuck Drivers

Catalog Number	Color Coded	Hex Opening in.	Insert Dia. in. (mm)	Nose Dia. in. (mm)	O/A Lgth. in. (cm)
MSHL14	Red	1/4"	1/4" (6)	7/16" (11)	2-9/16" (65)
MSHL14T (Bulk Tub of 100)	Red	1/4"	1/4" (6)	7/16" (11)	2-9/16" (65)
MSHL516	Yellow	5/16"	1/4" (6)	1/2" (13)	2-9/16" (65)
MSHL516T (Bulk Tub of 100)	Yellow	5/16"	1/4" (6)	1/2" (13)	2-9/16" (65)
MSHL38	Blue	3/8"	1/4" (6)	9/16" (14)	2-9/16" (65)
MSHL716	Brown	7/16"	1/4" (6)	11/16" (18)	2-9/16" (65)

CONNEXT™ Short Chuck Drivers

Catalog Number	Color Coded	Hex Opening in.	Insert Dia. in. (mm)	Nose Dia. in. (mm)	O/A Lgth. in. (cm)
MSH14	Red	1/4"	1/4" (6)	7/16" (11)	1-3/4" (44)
MSH14T (Bulk Tub of 100)	Red	1/4"	1/4" (6)	7/16" (11)	1-3/4" (44)
MSH516	Yellow	5/16"	1/4" (6)	1/2" (13)	1-3/4" (44)
MSH516T (Bulk Tub of 100)	Yellow	5/16"	1/4" (6)	1/2" (13)	1-3/4" (44)
MSH38	Blue	3/8"	1/4" (6)	9/16" (14)	1-3/4" (44)

CONNEXT™ Extra Long Chuck Drivers

Catalog Number	Color Coded	Hex Opening in.	Insert Dia. in. (mm)	Nose Dia. in. (mm)	O/A Lgth. in. (cm)
MSHML14	Red	1/4"	1/4" (6)	7/16" (11)	4" (102)
MSHXL14	Red	1/4"	1/4" (6)	7/16" (11)	6" (152)
MSHXL14T (Bulk Box of 50)	Red	1/4"	1/4" (6)	7/16" (11)	6" (152)
MSM516	Yellow	5/16"	1/4" (6)	1/2" (13)	4" (102)
MSHXL516	Yellow	5/16"	1/4" (6)	1/2" (13)	6" (152)
MSHXL516T (Bulk Box of 50)	Yellow	5/16"	1/4" (6)	1/2" (13)	6" (152)
MSHXL38	Blue	3/8"	1/4" (6)	9/16" (14)	6" (152)

1/4" Hex Shank Power Bits

Catalog Number	Description	Point Size	Shank Dia. in.	O/A Lgth. in.
MBLP2	Hex Shank Power Bit	3	1/4"	1-15/16"
MBLP3	Hex Shank Power Bit	2	1/4"	1-15/16"
MBLP4	Hex Shank Power Bit	2	1/4"	2-3/4"
MBSP2	Hex Shank Short Bit	2	1/4"	1"

Power Bit Extensions

Catalog Number	Description	Hex Opening in.	Shank Dia. in.	Nose Dia. in.	O/A Lgth. in.
BHE6	Power Bit Extension	1/4"	1/4"	9/16"	6"
BHE10	Power Bit Extension	1/4"	1/4"	9/16"	10"

1/4" Hex Shank Insert Bits Holder

Catalog Number	Description	Hex Opening in.	Shank Dia. in.	Nose Dia. in.	O/A Lgth. in.
MBH14	Bit Holder	1/4"	1/4"	7/16"	3"

Quick Change Hex Adapter

Catalog Number	Description	Hex Opening in.	Shank Dia. in.	Bore Depth in.	Sleeve Dia. in.	O/A Length in.
HAD1	Hex Adapter	1/4"	3/8"	7/8"	7/8"	1-3/4"

Cushioned-Gripped

“T” Handle Hex Key Sets

Extra long, hardened and tempered alloy steel “T” Handle hex keys provide extra reach and extra leverage. Plus, vinyl cushion grips and comfort provide added torque.

- Big 6” and 9” sets consist of 8 sizes: 3/32”, 7/64”, 1/8”, 9/64”, 5/32”, 3/16”, 7/32” and 1/4”.
- Kits are packaged in reusable, clear vinyl pouches with velcro-tab closures.
- Red vinyl grips imprinted with sizes make these keys easy to spot on the job and easy to retrieve from your tool kit or tool box.
- Rust-resistant finish on hex shafts assures long service life.
- Popular 1/8”, 5/32” and 3/16” sizes are also available individually.



6” Gripped Hex “T” Set

6” Long “T” Handle Keys
8 Sizes (3/32”-1/4”)



9” Gripped Hex “T” Key Set

9” Long “T” Handle Keys
8 Sizes (3/32”-1/4”)

Specifications

Catalog Number	Description
WT6SG	6” Long T Handle Keys, 8 Sizes (3/32”-1/4”)
Individual 6” Long Wrenches	
WT618G	1/8” T-Hex Key 6” long
WT6532G	5/32” T-Hex Key 6” long
WT6316G	3/16” T-Hex Key 6” long

6”

Catalog Number	Description
WT9SG	9” Long T Handle Keys, 8 Sizes (3/32”-1/4”)
Individual 9” Long Wrenches	
WT918G	1/8” T-Hex Key 9” long
WT9532G	5/32” T-Hex Key 9” long
WT9316G	3/16” T-Hex Key 9” long

9”

Folding Hex Key Sets

Produced from tough alloy steel

Catalog Number	W19	W29	W45	W48
Description	Small Pocket	Deluxe Pocket	Large Sizes	Extra Long
Handle Length	3-5/8"	4-1/4"	5-1/4"	5-1/4"
Number of Keys	9	9	5	8
Hex Sizes - Width Across Flats				
	.050"	—	—	—
	1/16"	—	—	—
	5/64"	5/64"	—	—
	3/32"	3/32"	—	3/32"
	7/64"	7/64"	—	7/64"
	1/8"	1/8"	—	1/8"
	9/64"	9/64"	—	9/64"
	5/32"	5/32"	—	5/32"
	3/16"	3/16"	3/16"	3/16"
	—	7/32"	7/32"	7/32"
	—	1/4"	1/4"	1/4"
	—	—	5/16"	—
	—	—	3/8"	—

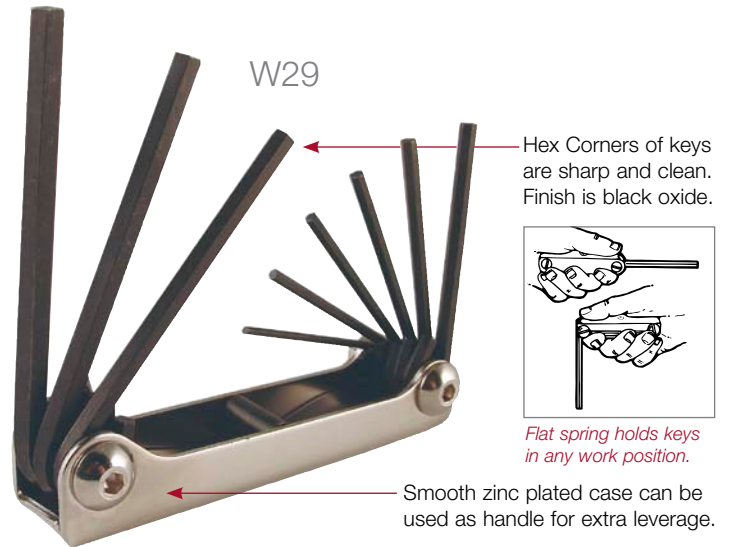

Ball Tip "L" Wrench Set

Wrench Set stores in Handy reusable case.



WB12S

TWO TOOLS IN ONE!
Standard Hex end for maximum torque.
Ball end for angles.

*Tough alloy steel.
Black oxide Finish*



Refrigeration Lengths "L" Hex Keys

*Available in 6" and 12" long series.
Tough alloy steel, black oxide finish,
In reusable vinyl pouch.*



W6

9 Piece Set
6" Length



W12

7 Piece Set
Big 12" Length

Specifications

Catalog Number	Description
WBL12S	12 Piece Ball Tip Wrench Set
W19	9 Piece Hex Key Set (.050"-3/16")
W29	9 Piece Hex Key Set (5/64"-1/4")
W45	5 Piece Hex Key Set (3/16"-3/8")
W48	8 Piece Hex Key Set (3/32"-1/4")
W6	6" 9 sizes: 5/64, 3/32, 7/64, 1/8, 9/64, 5/32, 3/16, 7/32 and 1/4"
W12	12" 7 sizes: 5/64, 3/32, 1/8, 5/32, 3/16, 7/32 and 1/4"
Individual "L" 12" Long Hex Key Wrenches	
W12532	12" Long hex key size 5/32"