

Installation Instructions

Radiator thermostat RA 2000, universal model

Installation, temperature setting, limitation and blocking, theft protection

Installation

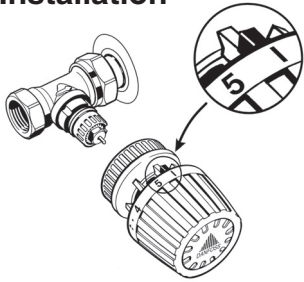

Remove the valve cover.
Check that the thermostat is set at the factory setting of 5.

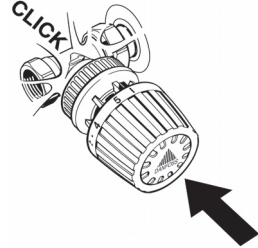

Push the thermostat firmly onto the valve until an audible "click" is heard.

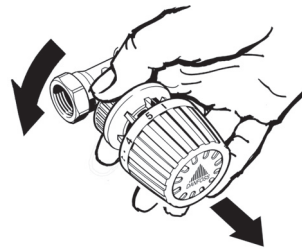

To remove the thermostat turn the base counter-clockwise. This will also reset the the snap-action mechanism when an audible "click" is heard.

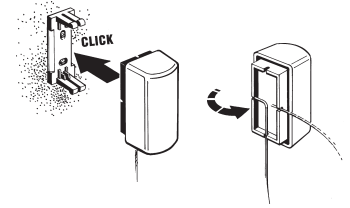

Attach the sensor bracket to the desired location. Pull out the required length of capillary tube and secure to the sensor as shown. Push the sensor onto the base.

Mounting Operator with Built-in Sensor

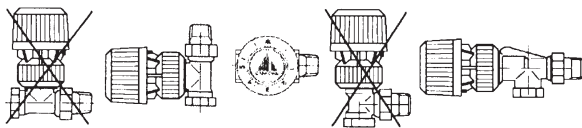

The sensor must not be in a drafty location or be covered. **Do not install above a heat source.**

Mounting Operator with Remote Sensor

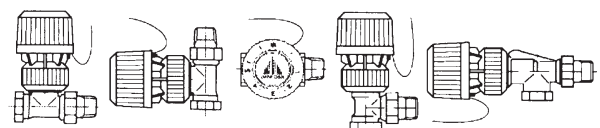

Temperature setting

45	49	57	63	68	73	79	82°F		
7	9,5	14	17	20	23	26	28°C		
	*	1	2	•	•	•	4	5	

* = Frost protection setting

The required room temperature is obtained by turning the thermostat knob. The numbers on the dial correspond to the approximate temperatures of the scale.

The temperatures indicated are guidelines only. The actual room temperature will depend on structural factors affecting the thermostats, location, etc.

Limiting and blocking the setting range Spare limit pins (30pcs) 013G1215

Upper limit setting (max. setting)

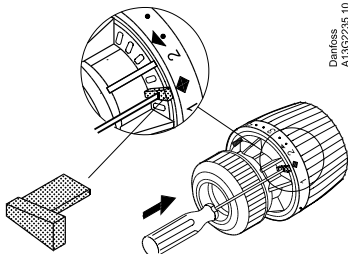

Example: Required max. value = "4"
- Set thermostat at "4"
- Remove a pin from the bottom of the thermostat with a screwdriver and mount it under the diamond mark on the knob (between setting positions 1 and 2).

Lower limit setting (min. setting)

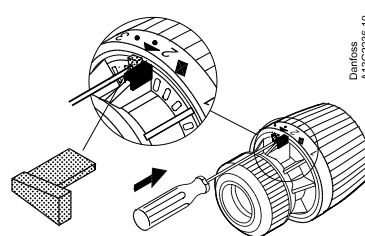

Example: Required min. value = "2"
- Set thermostat at "2"
- Remove a pin from the bottom of the thermostat with a screwdriver and mount it under the triangle mark on the knob (between setting positions 2 and 3).

Locking setting

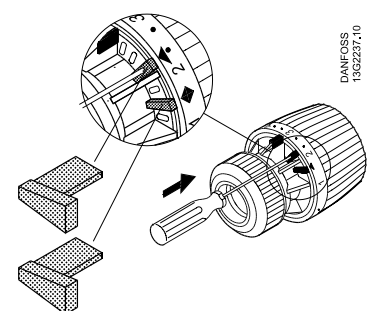

Example: Required locked value = "3"
- Set thermostat at "3"
- Remove both pins from the thermostat.
- Place one pin under the diamond mark and the other pin under the triangle mark.

Theft protection

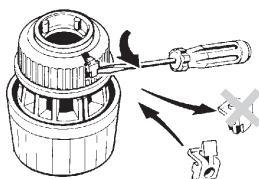

Remove the cover and install the theft protection button, code 013G5245 (20 pcs) without pushing it all the way in.

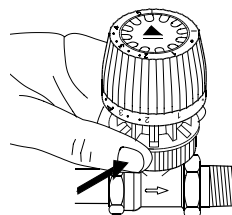

Once the thermostat is mounted on the valve, push in the theft protection device. The thermostat cannot be removed.

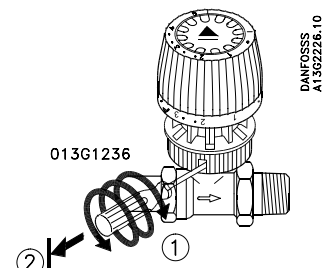

To remove the theft protection use screwdriver 013G1236 and screw into the hole (1). Pull out until the stop is reached (2).