

Service & Installation

Section

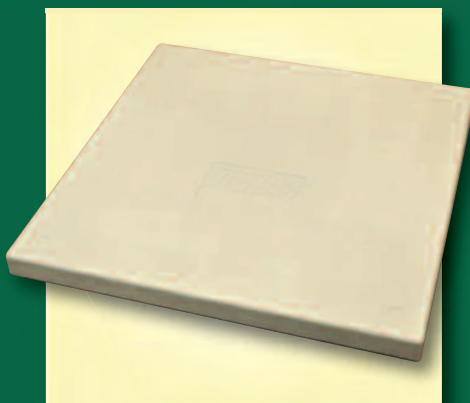
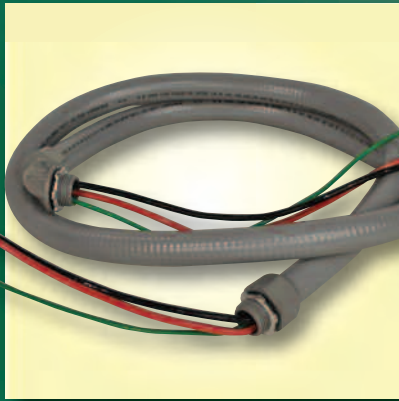

Table Of Contents



| MARS Description | Page |
|--|------------------------------|
| A/C Condenser Pads | SI-3 |
| A/C Mounting Brackets | SI-3 |
| A/C Whips | SI-9 |
| Access Fittings & Valves | SI-55 – SI-56 |
| Anti Vibration Pads | SI-4 |
| Batteries | SI-98 |
| Brazing Alloys, Solders & Fluxes | SI-72 – SI-74, SI-83 – SI-84 |
| Brushes | SI-110 – SI-112 |
| Cable Cutter | SI-43 |
| Chemicals | SI-57 |
| Circuit Breaker Branch Panels | SI-13 |
| Circuit Breakers | SI-12 |
| Circuit Protection | SI-93 |
| Clipboards | SI-143 |
| Compressor Terminal Repair Kit | SI-76 – SI-77 |
| Condensate Products | SI-92 |
| Condenser Filter | SI-50 |
| Conduit | SI-9 |
| Cords & Cord Sets | SI-49 |
| Disconnects & Safety Switches | SI-6 – SI-8 |
| Duct Straps, Pipe Hangers & Hooks | SI-50, SI-52 |
| Electrical Fittings | SI-47 – SI-48 |
| Expansion Valves | SI-63 |
| Filter & Heat Pump Driers | SI-58 – SI-61, SI-63 – SI-64 |
| Fittings, Nylon & Galvanized | SI-91 |
| Flashlights & Accessories | SI-99 – SI-101 |
| Fuse & Power Blocks, Edison | SI-32 – SI-34 |
| Fuse & Power Blocks, Ferraz Shawmut | SI-21 – SI-22 |
| Fuse Pullers | SI-32, S-115 |
| Fuses, Edison | SI-23 – SI-31 |
| Fuses, Ferraz Shawmut | SI-14 – SI-21 |
| Fuses, Zebra | SI-35 |
| Garden Hoses & Sprayers | SI-139 |
| Gas Appliance Fittings & Valves | SI-88 |
| Gloves | SI-120, SI-140 – SI-141 |
| Hand Cleaners | SI-121 |
| Hardware, Screws, Washers, Nuts, Anchors | SI-107 – SI-109 |
| Heat Pump Risers | SI-4 |
| Heat Shrink Tubing | SI-97 |
| Hose Clamps | SI-86 – SI-87 |

| MARS Description | Page |
|--------------------------------------|----------------------------------|
| Knives, Repl. Blades & Sharpeners | SI-54, SI-118 |
| Light Bulbs | SI-44 |
| Lines & Tubing | SI-75 |
| Maintenance Products | SI-122 – SI-123, SI-131 – SI-138 |
| Markers | SI-133 |
| Outlet Boxes | SI-45 – SI-46 |
| Plumbing & Piping Products | SI-81 – SI-85 |
| PVC Cement, Cleaner & Primer | SI-89, SI-129, SI-134 |
| PVC Fittings & Traps | SI-90 |
| Refrigerant ID Labels | SI-103 |
| Replacement Cores for Filter Driers | SI-62 |
| Roof Flashing & Furnace Legs | SI-5 |
| Rooftop Support Systems | SI-5 – SI-6 |
| Rope, Tie Downs and Tarps | SI-51 |
| Safety Products | SI-119 |
| Scales | SI-103 |
| Sealant Products | SI-124 – SI-128 |
| Service Manifolds & Accessories | SI-69 |
| Sight Glasses | SI-62 |
| Soft Copper Refrigeration Coils | SI-75 |
| Solderless Terminals | SI-77 – SI-80 |
| Specialty Tools | SI-76 |
| Tape | SI-93, SI-128 – SI-130 |
| Test Instruments | SI-94 – SI-96, SI-102, SI-105 |
| Test Leads | SI-97 |
| Textbooks | SI-144 |
| Thermometers | SI-104 |
| Thermostat Guards | SI-10 - SI-11 |
| Thermostat Wire | SI-41 – SI-42 |
| Tool boxes & Bags | SI-140 – SI-142 |
| Tools, Hand | SI-113 – SI-117 |
| Tubing Tools | SI-65 – SI-68 |
| Vibration absorbers, Stainless Steel | SI-70 |
| Welding/Brazing/Cutting Tools | SI-106 |
| Wire Caddy | SI-43 |
| Wire Markers | SI-43 |
| Wire Nuts | SI-37 – SI-38 |
| Wire Products | SI-39 – SI-40 |
| Wire Ties | SI-53 |
| Wiring Devices | SI-35 – SI-36 |
| Wrot Copper Fittings | SI-71 |



MARS A/C Condenser Pads

MARS SERIES **935**

MARS A/C Condenser Pads

MARS is pleased to offer a full line of Air Conditioning Condenser Pads. These gray plastic pads are molded from polypropylene. The lightweight, one piece constructed pads are virtually unbreakable and built to last. Two and three inch thick pads are available.

Features & Benefits:

- UV stable – prevents weathering or cracking
- Chemical resistant • Solid wall construction
- Will not chip or crack • Lightweight
- Textured surface – prevents unit from sliding
- Unique footpads – prevent unit from sinking into ground
- Size molded in side of pad
- Drillable for attachment of unit

| MARS NO. | DESCRIPTION | CASE QTY. | MARS NO. | DESCRIPTION | CASE QTY. |
|----------|----------------|-----------|----------|----------------|-----------|
| 93560 | 24" x 24" x 2" | 44 | 93576 | 36" x 40" x 2" | 22 |
| 93561 | 24" x 36" x 2" | 22 | 93575 | 36" x 48" x 2" | 22 |
| 93564 | 30" x 24" x 2" | 22 | 93577 | 24" x 24" x 3" | 16 |
| 93565 | 30" x 30" x 2" | 22 | 93578 | 24" x 36" x 3" | 16 |
| 93567 | 30" x 40" x 2" | 22 | 93584 | 30" x 30" x 3" | 16 |
| 93562 | 32" x 32" x 2" | 22 | 93587 | 32" x 32" x 3" | 16 |
| 93563 | 32" x 38" x 2" | 22 | 93592 | 36" x 36" x 3" | 16 |
| 93572 | 32" x 44" x 2" | 22 | 93593 | 36" x 40" x 3" | 16 |
| 93573 | 36" x 36" x 2" | 22 | 93594 | 36" x 48" x 3" | 16 |

93560

- Rugged, easy to handle
- Weed wackers won't destroy the corners

SERVICE & INSTALLATION



A/C Mounting Brackets

MARS SERIES **936**

MARS A/C Mounting Brackets

Heavy duty engineered steel A/C brackets are used for mounting A/C condensers and heat pumps on vertical walls. Brackets include mounting holes and are finished in a durable gray powder coat.

| MARS NO. | DESCRIPTION | MARS PACK |
|----------|---------------------------------|-----------|
| 93630 | 30" Powder Coated Steel Bracket | 1 Pair |
| 93631 | 36" Powder Coated Steel Bracket | 1 Pair |
| 93632 | 42" Powder Coated Steel Bracket | 1 Pair |
| 93636 | 48" Powder Coated Steel Bracket | 1 Pair |

93630

Anti-Vibration Pads

MARS SERIES **521**



Anti-Vibration Pads

MARS offers a complete line of anti-vibration pads. These high quality rubber pads provide maximum loading of 60 lbs. per square inch. Anti-vibration pads can be used on any type of mechanical/electrical machines such as pumps, motors, air conditioning units, generators, compressors, etc. The plain rubber pads have grooves on both sides. The cork rubber pads are the same but with the added advantage of reduction in sound level. The natural rubber Iso-Pads can be easily cut for odd sized dimensions under equipment legs and supports. The use of these pads eliminates the need for bolting down equipment to the floor. These Iso-Pads provide superior isolation, attenuation and vibration characteristics.

SERVICE & INSTALLATION

| MARS NO. | DESCRIPTION | MARS PACK |
|----------|------------------------------|-----------|
| 52101 | 2" x 2" x 3/8" Rubber | 1 |
| 52102 | 3" x 3" x 3/8" Rubber | 1 |
| 52103 | 4" x 4" x 3/8" Rubber | 1 |
| 52104 | 6" x 6" x 3/8" Rubber | 1 |
| 52107 | 18" x 18" x 3/8" Rubber | 1 |
| 52108 | 2" x 2" x 7/8" Cork/Rubber | 1 |
| 52109 | 3" x 3" x 7/8" Cork/Rubber | 1 |
| 52110 | 4" X 4" X 7/8" Cork/Rubber | 1 |
| 52111 | 6" x 6" x 7/8" Cork/Rubber | 1 |
| 52114 | 18" x 18" x 7/8" Cork/Rubber | 1 |
| 52115 | 2" x 2" x 3/4" Iso-Pad | 1 |
| 52116 | 4" x 4" x 3/4" Iso-Pad | 1 |
| 52117 | 18" x 18" x 3/4" Iso-Pad | 1 |
| 52119 | 2" x 2" x 7/8" Foam/Rubber | 1 |
| 52118 | 4" x 4" x 7/8" Foam/Rubber | 1 |
| 52120 | 6" x 6" x 7/8" Foam/Rubber | 1 |
| 52122 | 18"x18"x7/8" Foam/Rubber | 1 |

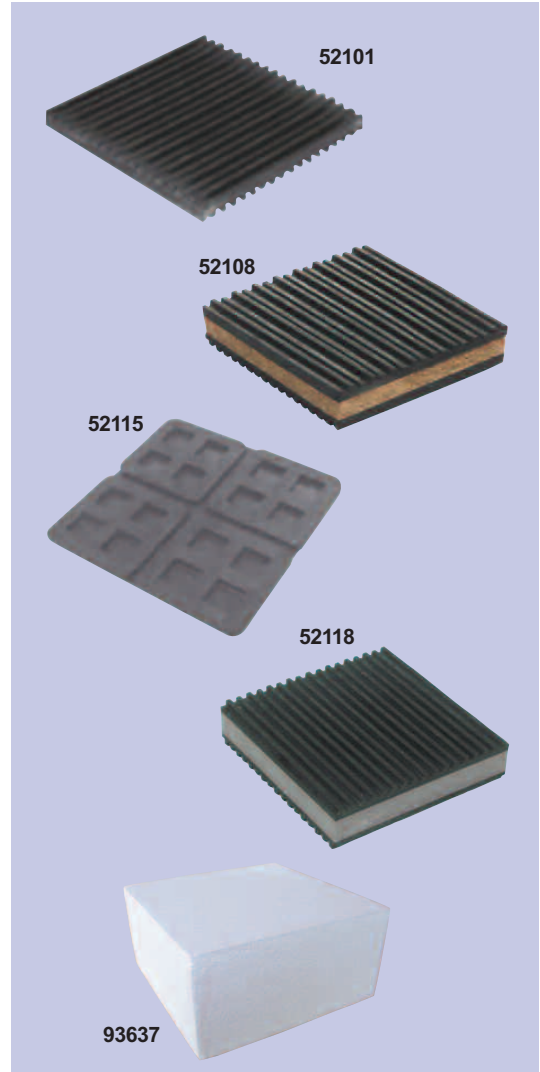

MARS Air Handler Blocks

- Lightweight 2 lb styrofoam block
- 8" x 8" x 4"

Packaged in boxes of 20 (21 boxes per pallet)

| MARS NO. | DESCRIPTION | MARS PACK |
|----------|--------------------------------|-----------|
| 93637 | 8" x 8" x 4" Air Handler Block | 20 |

Heat Pump Risers

MARS SERIES **936**



MARS Heat Pump Risers

Heavy duty composite heat pump risers are available in 2 popular heights in a cost effective 1 piece design as well as a 2 piece terrain adaptable design. Each riser includes factory installed buytl mastic patches on the top and bottom to absorb vibration and reduce noise.

| MARS NO. | DESCRIPTION | MARS PACK |
|----------|----------------------------|-----------|
| 93600 | 3" 1 Piece Heat Pump Riser | 48 |
| 93602 | 3" 2 Piece Heat Pump Riser | 32 |
| 93601 | 6" 1 Piece Heat Pump Riser | 24 |
| 93603 | 6" 2 Piece Heat Pump Riser | 16 |
| 93604 | 4" Riser Extension | 16 |



Roof Flashings & Furnace Legs

MARS SERIES **790**

Roof Flashings

Galvanized no calk® roof flashings feature a one-piece construction which insures a positive leak proof installation every time. Specially formulated elastomeric collar allows the vent stack plenty of room for expansion and contraction. The patented double seal no-calk collar "gives" with the pipe, without breaking the water tight seal. The galvanized base is made from 24 gauge deep drawing steel extra high with no seams.

Flex Flash flashings are manufactured from a special formulated elastomer material which is extremely flexible and durable. They permit the vent stack to expand and contract freely without disrupting the seal between pipe and flashing collar. The flashing adjusts to most any angle and adapts to all type of pipe; copper, cast iron, galvanized or plastic. Fits up to 45° angle.

| MARS NO. | DESCRIPTION | MARS PACK |
|----------|---|-----------|
| 79360 | 1 1/4" - 1 1/2" no calk galvanized | 12 |
| 79361 | 2" no calk galvanized | 12 |
| 79362 | 3" no calk galvanized | 12 |
| 79364 | 1/2", 3/4", 1" no calk galvanized solar | 12 |

MARS Easy Leveler™ Furnace Legs

- Includes 4 easy leveler legs & sheet metal screws
- Designed to level a furnace & air conditioning coil for proper drainage.
- Proper leveling helps eliminate standing water, thus reducing bacteria
- Easily adjustable even after installation
- Legs can support up to 400 lbs.
- Adjustable from 2-3/4" to 4" in height

| MARS NO. | DESCRIPTION | MARS PACK |
|----------|-------------------------|-----------|
| 79095 | Adjustable furnace legs | 12 |

Economy Furnace Mounting Blocks

- Holds furnace 2" off the floor
- Composite construction
- Absorbs vibration, reduces noise
- Peel & stick installation

| MARS NO. | DESCRIPTION | MARS PACK |
|----------|---------------------------------|-----------|
| 79085 | Economy furnace mounting blocks | 12 |



SERVICE & INSTALLATION



C-Port Rooftop Support Systems

MARS SERIES **939**

Rooftop Support Systems

Economy CX-Series

- Base only
- Material – 100% recycled rubber, UV resistant
- Maximum Load – 2 – 800 lbs.

CX Series rooftop support is designed as an economic alternative when a high load bearing is not required. They are perfect for supporting conduit or smaller pipe.

C-Series

- Material – 100% recycled rubber, UV resistant
- Maximum Load – 750 lbs./ft

C Series channel support is designed for superior support of gas and refrigeration piping systems, cable tray, electrical conduit multiple lines, HVAC equipment and many other applications.

| MARS NO. | DESCRIPTION | MARS PACK | CASE QTY. |
|----------|-----------------------------------|-----------|-----------|
| 93950 | CX-Series 4" H x 6" W x 9.6" L | 1 | 170 |
| 93951 | C-Series 4 7/8" H x 6" W x 9.6" L | 1 | 170 |

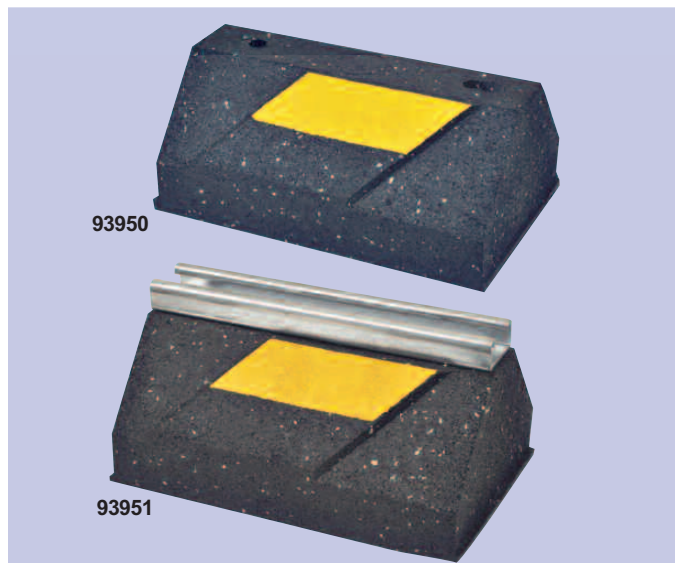

The largest selection of motors, components and accessories for the HVAC/R Industry

Rooftop Support Systems

MARS SERIES **939**



Caddy® Pyramid ST Series Rooftop Support

Caddy® Pyramid ST Series Rooftop Support is roof-friendly, high-quality, versatile and durable for roofing applications.

Features:

- Thermoplastic base is UV stabilized and weatherproof for long lasting
- Fixed-height mounting platform 4" off the roof surface and 10" of usable strut length, provides excellent load distribution
- Structurally engineered to support up to 1,000 lbs
- Hot-dipped galvanized finish
- Superior corrosion protection
- Supports the green building requirements, bases are made from recycled material and can contribute toward earning LEED credit

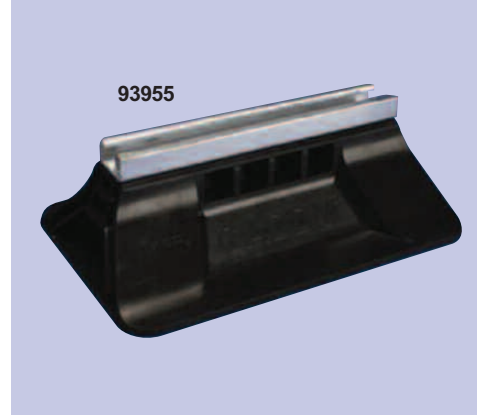

93955

| MARS NO. | Mfg No. | Height | Length (1) | Length (2) | Width | Surface Area | MAX. Rec. Load |
|----------|-----------|--------|------------|------------|-------|--------------|----------------|
| 93955 | RPS360400 | 4" | 10" | 12.5" | 8" | 94.3" | 1,000 lbs. |

* Max. recommended load at 10.6 psi roof loading. Contact project or roofing engineer for maximum allowable load on individual project roof system.

SERVICE & INSTALLATION

Disconnects & Safety Switches

MARS SERIES **833 & 803**



MARS Front Open Pullout Disconnect Boxes - NEMA 3R

MARS offers both fusible and non-fusible single phase air conditioner disconnects. These units provide a disconnecting means which should be located within sight from and readily accessible from the air conditioning or refrigerating equipment. UL listed. MARS #83315 is also CUL listed.

| MARS NO. | DESCRIPTION | CASE QTY |
|----------|--|----------|
| 83315 | 60 amp non-fused, single phase | 6 |
| 83316 | 30 amp fused, single phase | 6 |
| 83317 | 60 amp fused, single phase | 6 |
| 83396 | Compact 30 amp fused, single phase | 6 |
| 83335 | Generic brand 60 amp non-fused, single phase | 6 |

MARS Side Open Pullout Disconnect Boxes - NEMA 3R

The MARS Side Open Disconnect Boxes are contractor friendly and feature a unique side opening door, allowing easy access to the work area. The powder coated UV rated finish provides superior esthetics and greater longevity. The patented "finger safe" pullout section prevents accidental contact with electrodes. Easy to remove knockouts and a secure locking mechanism are also featured. This Pullout Disconnect Box is the ideal choice for the busy contractor.

MARS 80328 features an on/off switch so there are no pullout handles to be lost.

Specifications:

- Single phase, 240V
- 10,000 amp rated
- NEMA 3R, rainproof
- UL & CUL rated

| MARS NO. | DESCRIPTION | STD. PACK | CASE QTY |
|----------|----------------------------------|-----------|----------|
| 80315 | 60 amp non-fused | 6 | 6 |
| 80316 | 30 amp fused | 6 | 6 |
| 80317 | 60 amp fused | 6 | 6 |
| 80328 | 60 amp fused – Switch Disconnect | 6 | 6 |



83316, 17

83335

83315

80328

80315

Easy to remove concentric knockouts & secure locking mechanism

Unique side opening door permits greater visibility and access to work area

Patented "Finger Safe" Pullout section prevents accidental contact with electrodes



Disconnects & Safety Switches

MARS SERIES **833 & 803**

Midwest A/C Disconnects - NEMA 3R

| MARS NO. | DESCRIPTION | CASE QTY. |
|----------|--------------------------------|-----------|
| 83385 | 60 amp non-fused, single phase | 6 |
| 83386 | 30 amp fused, single phase | 6 |
| 83387 | 60 amp fused, single phase | 6 |

Pullouts For MARS Disconnect Boxes

MARS offers both fusible and non-fusible single phase non-metallic air conditioner disconnects. These horse power rated units are constructed of Noryl® thermoplastic for extended and rugged durability. Units are corrosion resistant, weatherproof, and maintenance free. UL listed and CSA certified.

| MARS NO. | DESCRIPTION | CASE QTY |
|----------|--|----------|
| 83313 | 60 amp non-fused pullout for 83315 | 1 |
| 83314 | 30 amp fused pullout for 83316 | 1 |
| 83318 | 60 amp fused pullout for 83317 | 1 |
| 83319 | 30 amp fused pullout for 83396 | 1 |
| 80312 | 60 amp non-fused pullout for 80315 & 80308 | 1 |
| 80313 | 30 amp fused pullout for 80316 | 1 |
| 80314 | 60 amp fused pullout for 80317 | 1 |

MARS A/C Disconnect/GFCI Receptacle Combination

MARS A/C Disconnect/ GFCI Receptacle Combination disconnects provide a convenient low cost means to satisfy NEC Article 210.63 requirements for HVAC/R Equipment Outlets and Article 406.8(B)(1) for Receptacle – Wet Locations. The NEMA 3R design insures a safe, weather tight installation for residential, light commercial and even some industrial applications.

Features & Benefits:

- 60 amp, non-fused, pullout type
- 240 volt A/C, single phase
- 15 amp, 125V GFCI duplex receptacle included
- UL & CUL listed
- Meets NEC #210.63 & #406.8(B)(1)
- Compact size – 5"x7"x4"
- Removable cover
- Heavy galvanized 'G90' steel with highest quality electro-deposition finish resists corrosion and fading
- NEMA 3R rated

| MARS NO. | DESCRIPTION | MARS PACK |
|----------|-------------------------------|-----------|
| 83308 | Pullout disconnect/receptacle | 4 |

MARS Side Open Pullout Disconnect w/GFCI Receptacle

The MARS Side Open Disconnect w/GFCI Receptacle provides a convenient low cost means to satisfy NEC 2003 code changes requiring that a GFCI receptacle with a "while in use" cover be within a 25ft line of sight of the condenser unit. The pre-wired receptacle with stripped wire ends makes installation of disconnect and receptacle quick and easy. This unit provides a significantly lower "installed cost" to the contractor when compared to installing a standard disconnect and separate GFCI receptacle with "while in use" cover to comply with the new NEC code change.

Additional features and benefits include: Convenient electrical power cord channel w/retaining clip for easy and safe use of portable tools; Large wiring compartment for both disconnect switch and receptacle; Angled receptacle mounting to eliminate the possibility of crushing portable electrical plugs when closing "while in use" cover; Attractive side opening cover design for ease of installation; Ultra UV powder coating.

Specifications:

- 60 amp, non-fused, pullout type
- Pre-wired 15A, 125V GFCI receptacle included
- 240 volt, single phase
- 10,000 amp rated
- NEMA 3R & UL rainproof
- UL & CUL approved
- Rated for 10HP @ 240 volts
- Meets NEC #210.63 & #406.8(B)(1)
- Multiple patents pending

| MARS NO. | DESCRIPTION | STD. PACK | CASE QTY |
|----------|--------------------------------------|-----------|----------|
| 80308 | Pullout disconnect W/GFCI receptacle | 6 | 6 |



SERVICE & INSTALLATION



The largest selection of motors, components and accessories for the HVAC/R Industry

Disconnects & Safety Switches

MARS SERIES **833**



Midwest Non-Metallic Disconnects - NEMA 3R

Midwest Electric offers both fusible and non-fusible single phase non-metallic air conditioner disconnects. These horse power rated units are constructed of Noryl® thermoplastic for extended and rugged durability. Units are corrosion resistant, weatherproof, and maintenance free. UL listed and CSA certified.

| MARS NO. | DESCRIPTION | CASE QTY |
|----------|--------------------------------|----------|
| 83312 | 60 amp non-fused, single phase | 6 |
| 83306 | 30 amp fused, single phase | 6 |
| 83307 | 60 amp fused, single phase | 6 |



Midwest Three Phase Pullout Disconnects - 240V - NEMA 3R

Midwest Electric three phase pull out disconnects and single phase non-automatic switches are manufactured of heavy zinc coated steel with highest quality electro-deposition paint finish for maximum corrosion resistance. The three phase disconnects are available with and without fuse protection. Fusible units require three fuses. NEMA 3R.

| MARS NO. | DESCRIPTION | CASE QTY |
|----------|-------------------------------|----------|
| 83321 | 60 amp non-fused, three phase | 4 |
| 83322 | 30 amp fused, three phase | 4 |
| 83323 | 60 amp fused, three phase | 4 |



Midwest Non-Automatic Disconnects - Nema 3R

Midwest Electric has developed a new NEMA 3R, non-automatic A/C disconnect with a patent pending on/off switch mechanism so there is no pullout to lose. This UL and CSA listed disconnect features: a keyhole mounting slot for easy installation, a removable door for easy wiring access, straight in and out lugs for quick connections and six 1/2" x 3/4" x 1" concentric knockouts.

The single phase non-automatic disconnects do not provide overcurrent protection with manual internal on/off switch.

| MARS NO. | DESCRIPTION | CASE QTY |
|----------|---------------------|----------|
| 83328 | 60 amp, 240V, 10 HP | 4 |



Midwest Heat Pump Disconnects - NEMA 3R

Multiple disconnect devices are offered for heat pump applications that require individual disconnects for the heating and cooling cycles. The dual pull outs accommodate either a 30A/60A or 60A/60A puller combination. Units require four fuses.

| MARS NO. | DESCRIPTION | CASE QTY |
|----------|---------------|----------|
| 83324 | 90 amp fused | 1 |
| 83325 | 100 amp fused | 1 |



Midwest Evaporative Cooler Disconnects - NEMA 3R

Evaporative cooler applications not only require fusing but switching or receptacle functions depending on equipment type and local codes. The 20 ampere unit utilizes 2 T plug fuses. The 40 ampere unit utilizes 3 S plug fuses.

| MARS NO. | DESCRIPTION | CASE QTY |
|----------|---------------------------|----------|
| 83327 | 40 amp fused, receptacles | 1 |





Disconnects & Safety Switches

MARS SERIES **8333**

Midwest Non-Metallic, Non-Auto Switch Residential/Construction A/C Disconnect, NEMA 3R

| MARS NO. | DESCRIPTION | CASE QTY. |
|----------|--------------------------------|-----------|
| 83388 | 60 amp non-fused, single phase | 6 |

Midwest Metallic Residential/Construction, A/C Disconnects w/ Receptacle, NEMA 3R

| MARS NO. | DESCRIPTION | CASE QTY. |
|----------|--------------------------------|-----------|
| 83398 | 60 amp non-fused, single phase | 6 |

I-T-E Cartridge Fuse Type - UL Listed

1 Phase/2 wire, 3 Phase/3 wire, solid neutral

| MARS NO. | DESCRIPTION | TYPE | CASE QTY. |
|----------|----------------------------|------|-----------|
| 83330 | 30a-240V 2 pole, exterior | 3R | 1 |
| 83331 | 60a-240V 2 pole, exterior | 3R | 1 |
| 83333 | 30a-240V 2 pole, interior | 1 | 1 |
| 83334 | 60a-240V 2 pole, interior | 1 | 1 |
| 83336 | 30a-240V 3 pole, exterior | 3R | 1 |
| 83337 | 60a-240V 3 pole, exterior | 3R | 1 |
| 83339 | 30a-240V 3 pole, interior | 1 | 1 |
| 83340 | 60a-240V 3 pole, interior | 1 | 1 |
| 83368 | 100a-240V 3 pole, interior | 1 | 1 |

I-T-E Plug Fuse Type - UL Listed

1 Phase, solid neutral

| MARS NO. | DESCRIPTION | TYPE | CASE QTY. |
|----------|---------------------------|------|-----------|
| 83342 | 30a-120V 1 pole, interior | 1 | 6 |

I-T-E Unfused General Duty Enclosed Switches

1 Phase, solid neutral

| MARS NO. | DESCRIPTION | TYPE | CASE QTY. |
|----------|---|------|-----------|
| 83346 | 30a-240V 2 or 3 pole, 3 phase exterior | 3R | 1 |
| 83347 | 60a-240V 2 or 3 pole, 3 phase, exterior | 3R | 1 |
| 83349 | 30a-240V 2 or 3 pole, 3 phase interior | 1 | 1 |
| 83350 | 60a-240V 2 or 3 pole, 3 phase interior | 1 | 1 |
| 83352 | 60a-240V 1 or 2 pole, 1 phase exterior | 3R | 1 |

I-T-E Heavy Duty 3PH 600V - Type 1 - Indoor

| MARS NO. | DESCRIPTION | CASE QTY. |
|----------|------------------|-----------|
| 83353 | 30a-600V fused | 1 |
| 83354 | 60a-600V fused | 1 |
| 83355 | 100a-600V fused | 1 |
| 83356 | 30a-600V unfused | 1 |

I-T-E Heavy Duty 3PH 600V - Type 3R - Outdoor

| MARS NO. | DESCRIPTION | CASE QTY. |
|----------|-------------------|-----------|
| 83359 | 30a-600V fused | 1 |
| 83360 | 60a-600V fused | 1 |
| 83361 | 100a-600V fused | 1 |
| 83362 | 30a-600V unfused | 1 |
| 83363 | 60a-600V unfused | 1 |
| 83364 | 100a-600V unfused | 1 |



83330



83347



83353



83361

SERVICE & INSTALLATION



The largest selection of motors, components and accessories for the HVAC/R Industry

SI-8A

All Whips Bagged

MARS A/C Whips Non-Metallic Fittings

| MARS NO. | DESCRIPTION | MARS PACK |
|----------|--|-----------|
| 84131 | 4' x 1/2" #10 ga. non-metallic whip UL | 1 |
| 84133 | 4' x 3/4" #8 ga. non-metallic whip UL | 1 |
| 84135 | 6' x 1/2" #10 ga. non-metallic whip UL | 1 |
| 84137 | 6' x 3/4" #8 ga. non-metallic whip UL | 1 |
| 84139 | 8' x 1/2" #10 ga. non-metallic whip | 1 |
| 84141 | 8' x 3/4" #8 ga. non-metallic whip | 1 |
| 84143 | 10' x 3/4" #8 ga. non-metallic whip | 1 |

MARS A/C Whips Metallic Fittings

Non-metallic conduit with metal fittings

| MARS NO. | DESCRIPTION | MARS PACK |
|----------|------------------------------------|-----------|
| 84132 | 4' x 1/2" #10 ga. metallic whip UL | 1 |
| 84134 | 4' x 3/4" #8 ga. metallic whip UL | 1 |
| 84136 | 6' x 1/2" #10 ga. metallic whip UL | 1 |
| 84138 | 6' x 3/4" #8 ga. metallic whip UL | 1 |

MARS A/C Whips W/Two Straight Fittings

Metallic conduit with metal fittings

| MARS NO. | DESCRIPTION | MARS PACK |
|----------|-------------------------------------|-----------|
| 84148 | 4' x 1/2" #10 ga. non-metallic whip | 1 |
| 84145 | 4' x 1/2" #10 ga. non-metallic whip | 1 |

MARS A/C Whips All Metallic

| MARS NO. | DESCRIPTION | MARS PACK |
|----------|-----------------------------|-----------|
| 84125 | 4' x 1/2" all metallic whip | 1 |
| 84126 | 4' x 3/4" all metallic whip | 1 |
| 84127 | 6' x 1/2" all metallic whip | 1 |
| 84128 | 6' x 3/4" all metallic whip | 1 |

Sealtite® Flexible Metallic Conduit

Sealtite® flexible conduit provides protection for wet or oily locations. UL listed conduit has a continuous copper ground built into the core. All UL listed Sealtite® is UV resistant.

| MARS NO. | DESCRIPTION | MARS PACK |
|----------|--|-----------|
| 84102 | 1/2", metallic conduit, UL, boxed 100 ft | 1 |
| 84103 | 3/4", metallic conduit, UL, boxed 100 ft | 1 |
| 84110 | 1/2", metallic conduit, boxed 100 ft | 1 |
| 84111 | 3/4", metallic conduit, boxed 100 ft | 1 |

Sealtite® Flexible Non-Metallic Conduit

| MARS NO. | DESCRIPTION | MARS PACK |
|----------|--|-----------|
| 84117 | 3/8", non-metallic conduit, UL, boxed 100 ft | 1 |
| 84118 | 1/2", non-metallic conduit, UL, boxed 100 ft | 1 |
| 84119 | 3/4", non-metallic conduit, UL, boxed 100 ft | 1 |
| 84120 | 1", non-metallic conduit, UL, boxed 100 ft | 1 |
| 84121 | 1/2", non-metallic conduit, UL, polybag 25 ft | 1 |
| 84122 | 3/4", non-metallic conduit, UL, polybag 25 ft | 1 |



Thermostat Guards

MARS SERIES **702**



MARS Designer Series - Plastic Cover And Base

| INSIDE DIMENSIONS (inches) | BASE | HEIGHT | WIDTH | DEPTH |
|----------------------------|-------|--------|-------|-------|
| | Solid | 4.25 | 7.63 | 2.13 |
| | Ring | 4.13 | 7.07 | 2.25 |

| MARS NO. | DESCRIPTION | BASE | MARS PACK | CASE QTY. |
|----------|-----------------------|------|-----------|-----------|
| 70217 | BTG-DK clear plastic | Dual | 1 | 12 |
| 70219 | BTG-DO opaque plastic | Dual | 1 | 12 |

MARS Universal Series

| INSIDE DIMENSIONS (inches) | BASE | HEIGHT | WIDTH | DEPTH |
|----------------------------|-------|--------|-------|-------|
| | Solid | 8.25 | 5.38 | 3.25 |
| | Ring | 8.13 | 4.63 | 3.63 |
| | Solid | 7.25 | 5.38 | 3.25 |
| | Ring | 6.75 | 4.25 | 3.56 |

| MARS NO. | DESCRIPTION | BASE | MARS PACK | CASE QTY. |
|----------|------------------------------------|-------|-----------|-----------|
| 70220 | BTG-UK2 clear plastic | Dual | 1 | 12 |
| 70222 | BTG-UO2 opaque plastic | Dual | 1 | 12 |
| 70223 | BTG-UM metal | Solid | 1 | 12 |
| 70224 | BTG-UWM metal | Ring | 1 | 12 |
| 70236 | F336, extra key for all BTG guards | | 1 | 1 |

MARS Universal Series - White Metal Cover & Base

| INSIDE DIMENSIONS (inches) | BASE | HEIGHT | WIDTH | DEPTH |
|----------------------------|---------------------------|--------|-------|-------|
| | Solid | 6.25 | 9.38 | 3.00 |
| | Ring | 6.25 | 9.38 | 3.00 |
| | Opening dim. of ring base | 5.50 | 8.25 | .38 |

| MARS NO. | DESCRIPTION | BASE | MARS PACK | CASE QTY. |
|----------|---|-------|-----------|-----------|
| 70238 | BTG-UWM1 hinged wht. mtl. solid cover | Ring | 1 | 12 |
| 70243 | BTG-UM1D0H hinged wht. mtl. T-7300 Honeywell display & override opening | Solid | 1 | 12 |
| 70247 | BTG-UM1D0WR hinged wht. mtl. IF90 White Rogers override-display opening | Solid | 1 | 12 |

70217



70220

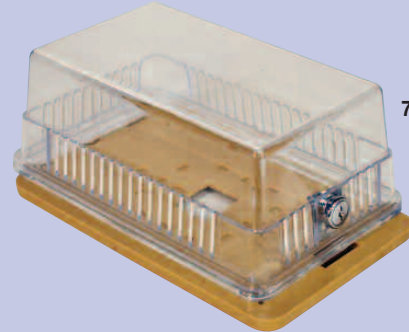

70222



70224

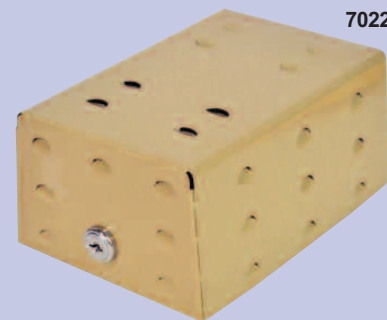

70238

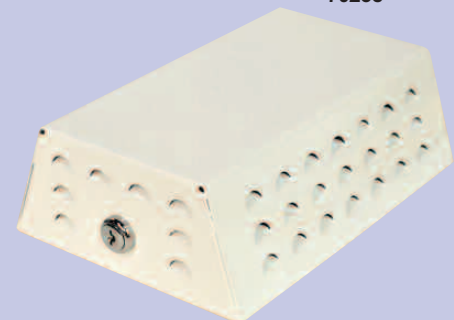

SERVICE & INSTALLATION

Thermostat Guards

MARS SERIES **702**



MARS Elite Series - Plastic Base

MARS offers a broad selection of thermostat guards. Popular models available include metal, clear plastic and opaque plastic designs. MARS thermostat guards are ideal for protecting thermostats in schools, industrial plants institutions, public facilities and other areas where unauthorized tampering could be a problem. These attractive units feature a rugged, light weight and compact design. All units supplied with key. Extra keys are available. Order part #70236 for the BTG thermostat guard key.

| INSIDE DIMENSIONS (inches) | BASE | HEIGHT | WIDTH | DEPTH |
|----------------------------|-------|-------------|-------|-------|
| | Solid | 3.88 | 3.5 | 2.5 |

| MARS NO. | DESCRIPTION | BASE | MARS PACK | CASE QTY. |
|----------|----------------------------|-------|-----------|-----------|
| 70201 | BTG-EK clear plastic cover | Solid | 1 | 12 |
| 70204 | BTG-EM metal cover | Solid | 1 | 12 |

MARS Classic Series - Plastic Base

| INSIDE DIMENSIONS (inches) | BASE | HEIGHT | WIDTH | DEPTH |
|----------------------------|-------|-------------|-------|-------|
| | Solid | 5.25 | 4.63 | 3.00 |
| | Ring | 5.25 | 4.63 | 3.25 |

| MARS NO. | DESCRIPTION | BASE | MARS PACK | CASE QTY. |
|----------|----------------------------|-------|-----------|-----------|
| 70205 | BTG-K clear plastic cover | Dual | 1 | 12 |
| 70207 | BTG-O opaque plastic cover | Dual | 1 | 12 |
| 70208 | BTG-KM metal cover | Solid | 1 | 12 |
| 70209 | BTG-KWM metal cover | Sing | 1 | 12 |

MARS Regal Series - Plastic Base

| INSIDE DIMENSIONS (inches) | BASE | HEIGHT | WIDTH | DEPTH |
|----------------------------|-------|-------------|-------|-------|
| | Solid | 6.38 | 3.5 | 3.00 |
| | Ring | 6.38 | 3.5 | 3.25 |

| MARS NO. | DESCRIPTION | BASE | MARS PACK | CASE QTY. |
|----------|--|-------|-----------|-----------|
| 70210 | BTG-RK clear plastic cover | Dual | 1 | 12 |
| 70212 | BTG-RO opaque plastic cover | Dual | 1 | 12 |
| 70213 | BTG-RM metal cover | Solid | 1 | 12 |
| 70214 | BTG-RWM metal cover | Ring | 1 | 12 |
| 70226 | F229R Plastic base for BTG-RO, RWM, RK, RB | Ring | 1 | 10 |

MARS Sentinel Series - Metal Cover And Base

| INSIDE DIMENSIONS (inches) | BASE | HEIGHT | WIDTH | DEPTH |
|----------------------------|-------|-------------|-------|-------|
| | Solid | 6.25 | 4.75 | 3.00 |
| | Ring | 6.00 | 3.82 | 3.13 |

| MARS NO. | DESCRIPTION | BASE | MARS PACK | CASE QTY. |
|----------|------------------------|-------|-----------|-----------|
| 70215 | BTG-54VL metal hinged | Solid | 1 | 12 |
| 70216 | BTG-54VLW metal hinged | Ring | 1 | 12 |

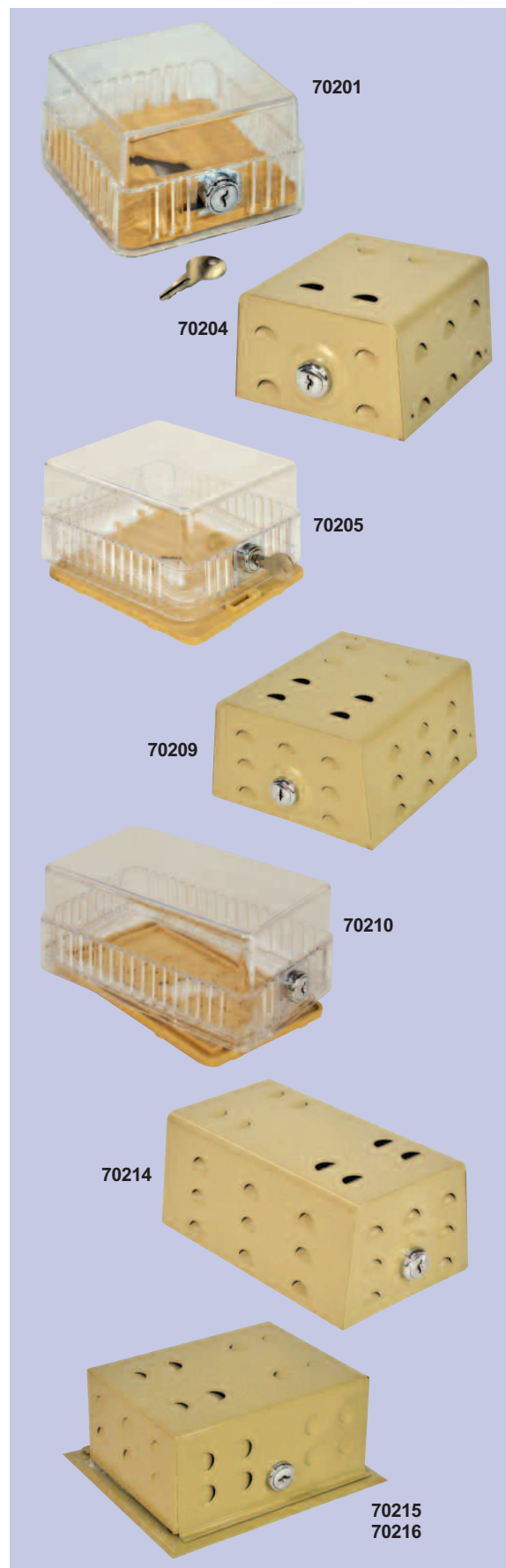

SERVICE & INSTALLATION

Circuit Breakers

MARS SERIES **832**



I-T-E Circuit Breakers Plug-In Interchangeable Type-Bulk

10,000 KA interrupting rating

| MARS NO. | DESCRIPTION | MARS PACK | CASE QTY. |
|----------|------------------------------|-----------|-----------|
| 83200 | 15a-120/240 VAC, 1 pole | 1 | 6 |
| 83201 | 20a-120/240 VAC, 1 pole | 1 | 6 |
| 83203 | 30a-120/240 VAC, 1 pole | 1 | 6 |
| 83220 | 15a-120/240 VAC, 2 pole | 1 | 3 |
| 83221 | 20a-120/240 VAC, 2 pole | 1 | 3 |
| 83222 | 25a-120/240 VAC, 2 pole | 1 | 3 |
| 83223 | 30a-120/240 VAC, 2 pole | 1 | 3 |
| 83224 | 35a-120/240 VAC, 2 pole | 1 | 3 |
| 83225 | 40a-120/240 VAC, 2 pole | 1 | 3 |
| 83226 | 45a-120/240 VAC, 2 pole | 1 | 3 |
| 83227 | 50a-120/240 VAC, 2 pole | 1 | 3 |
| 83228 | 60a-120/240 VAC, 2 pole | 1 | 3 |
| 83229 | 70a-120/240 VAC, 2 pole | 1 | 3 |
| 83230 | 80a-120/240 VAC, 2 pole | 1 | 3 |
| 83231 | 90a-120/240 VAC, 2 pole | 1 | 3 |
| 83232 | 100a-120/240 VAC, 2 pole | 1 | 3 |
| 83212 | Dual 20a-120/240 VAC, 1 pole | 1 | 3 |

I-T-E Circuit Breakers Plug-In Interchangeable Type-Carded

10,000 KA interrupting rating

| MARS NO. | DESCRIPTION | MARS PACK | CASE QTY. |
|----------|--------------------------|-----------|-----------|
| 83537 | 20a- 120/240 VAC, 2 pole | 1 | 3 |
| 83538 | 30a- 120/240 VAC, 2 pole | 1 | 3 |
| 83539 | 40a- 120/240 VAC, 2 pole | 1 | 3 |
| 83540 | 50a- 120/240 VAC, 2 pole | 1 | 3 |
| 83541 | 60a- 120/240 VAC, 2 pole | 1 | 3 |

General Electric Circuit Breakers-Bulk

| MARS NO. | DESCRIPTION | MARS PACK | CASE QTY. |
|----------|-------------------------------|-----------|-----------|
| 83522 | 15a-120/240 VAC, THQP 1 pole | 1 | 10 |
| 83527 | 30a-120/240 VAC, THQP 2 pole | 1 | 5 |
| 83431 | 20a-120/240 VAC, THQL 1 pole | 1 | 10 |
| 83437 | 20a-120/240 VAC, THQL 2 pole | 1 | 5 |
| 83436 | 30a-120/240 VAC, THQL 2 pole | 1 | 5 |
| 83438 | 40a-120/240 VAC, THQL 2 pole | 1 | 5 |
| 83439 | 50a-120/240 VAC, THQL 2 pole | 1 | 5 |
| 83440 | 60a-120/240 VAC, THQL 2 pole | 1 | 5 |
| 83444 | 100a-120/240 VAC, THQL 2 pole | 1 | 5 |

GE Replacement Breakers For Square D

MARS is pleased to introduce GE replacement circuit breakers for Square D QO® load centers. These Q line series circuit breakers lower your inventory costs by providing a single source for new construction & Square D QO® retrofit. These UL classified GE breakers are for use in place of Square D type QO circuit breakers.

| MARS NO. | DESCRIPTION | GE NO. | SQUARE D NO. |
|----------|-------------|----------|--------------|
| 83568 | 15A-1P | THQO1115 | QO115 |
| 83569 | 20A-1P | THQO1120 | QO120 |
| 83573 | 15A-2P | THQO2115 | QO215 |
| 83574 | 20A-2P | THQO2120 | QO220 |
| 83575 | 30A-2P | THQO2130 | QO230 |
| 83576 | 40A-2P | THQO2140 | QO240 |
| 83577 | 50A-2P | THQO2150 | QO250 |
| 83578 | 60A-2P | THQO2160 | QO260 |

SIEMENS

I-T-E® Electrical Products



83200



83537



83522



83437

Square D QO® load centers for which GE/MARS offers UL classified replacement circuit breakers:

| ≤70A | 100A | 125A | 200A | |
|-------------|------------------|----------------|-----------------|-------------|
| QQ2-4L50TTS | QO6-12L100DF/S | QO6-12M125FTRB | QO8-16M200FTRB | |
| QQ2-4L70F/S | QO6-12L100DFCU/S | QO12-24L125 | QO12L200 | |
| QQ2-4L70RB | QO6-12L100F/S | QO12-24L125RB | QO12L200RB | |
| QQ2-4L70TS | QO6-12L100RB | QO12L125 | QO20-30M200RB | |
| QQ2L30S | QO6-12L100RBCU | QO12L125RB | QO20-40M200 | |
| QQ2L30TTS | QO6-12L100TF/S | QO16-24L125 | QO20-40M200TF/S | |
| QQ2L40RB | QO6-12M125FTRB | QO16-24L125RB | QO24M200 | |
| QQ2TR | QO8-16L100DF/S | QO16L125 | QO30-40L200 | |
| QQ4-7M70TTS | QO8-16L100DFCU/S | QO20-24L125 | QO30-40L200RB | |
| | QO8-16L100TF/S | QO20L125 | QO30-40M200 | |
| | QO8-16L100F/S | QO2125BNF/S | QO30L200 | |
| | QO8-16L100RB | QO24L125 | QO30L200RB | |
| | QO20-30M150RB | QO8-16L100RBCU | QO12L125RB | QO30M200/RB |
| | QO20-30M150TF/S | QO8-16L100TF/S | QO24M125/RB | QO40M200/RB |
| | QO24L150 | QO12M100/RB | | |
| | QO24M150 | QO16M100/RB | | |
| | QO30L150 | QO20M100/RB | | |
| | QO30L150RB | QO2100BNF/S | | |
| | QO30M150/RB | QO24M100/RB | | |
| | | 225A | | |
| | | QO40M225 | | |
| | | QO42L225 | | |
| | | QO42L225RB | | |



83568



83573

Circuit Breaker Branch Panels

MARS SERIES **832**

Circuit Breakers

Zbreaker is the same circuit breaker now found on many high-end transformers and systems. It protects from damage caused by shorts, overheating, or wiring problems. A sticker is included so that, if the Tech desires, he can inform his customer where to press the "reset" button and possibly save a midnight service call. Kit includes wires and pre-installed terminals that allow you to easily plug it in to the connectors where a plastic-type fuse existed.

- Crystal-Clear Clamshell Package with Hanging Hole
- Full-Color Insert with Instructions

| MARS NO. | DESCRIPTION | MARS PACK |
|----------|-----------------------|-----------|
| 08574 | 3 Amp Circuit Breaker | 1 |
| 08575 | 5 Amp Circuit Breaker | 1 |

I-T-E® EQ® Load Center Enclosures

I-T-E EQ® load centers with main lugs feature a combination trim boxed in one package.

- The trim fits both surface and flush mounting applications saving money and space
- Interiors offer removal in seconds
- Single phase, 3-wire design, 120/240 VAC
- One piece Albus bar construction. Designed for use only with I-T-E circuit breakers. UL listed
- Rated for 100,000 A IR
- Exclusive split neutral
- Main lugs and neutral on same plane, same drive
- Simple upper pan adjustment after trim is installed
- UL listed for 60/75 °C conductors
- 100% circuit breaker twistouts
- Indoor and outdoor enclosures available

| MARS NO. | DESCRIPTION | MARS PACK |
|----------|--|-----------|
| 83271 | 60a-2 pole 4 circuit, surface branch panel - type 1 | 1 |
| 83273 | 125a-4 pole 8 circuit, surface branch panel - type 1 | 1 |

Outdoor Enclosures - Type 3R

| MARS NO. | DESCRIPTION | MARS PACK |
|----------|--|-----------|
| 83277 | 60a-2 pole 4 circuit, outdoor enclosure | 1 |
| 83278 | 125a-4 pole 8 circuit, outdoor enclosure | 1 |

EQ Load Center

Main Lug and Main Breaker with Copper Bus

Features:

- Interiors offer removal in seconds
- Single Phase
- One piece bus bar construction designed for use only with circuit breakers
- Positive load side circuit breaker hook rails
- Outdoor NEMA Type 3R devices use HS Type hubs
- UL listed

Specifications:

- 1000,000 IR
- 4-16 Circuits, 100-225 Amperes
- 1 Phase, 3-Wire, SN
- 120/240V AC

The EQ Load Center is suitable for use as service entrance equipment when a main breaker (125A maximum) is back-fed in a branch and used with main breaker retainer clip. Copper Bus load centers are recommended for those applications where the environment may be severe. (i.e. farm and coastal areas)

Main Lug Load Center - Outdoor

| MARS NO. | AMP RATING | MAX 1 POLE NO. OF SPACES | NO OF CIRCUITS | QP MAX. 2-POLES | MARS PACK |
|----------|------------|--------------------------|----------------|-----------------|-----------|
| 83265 | 125 | 8 | 16 | 4 | 1 |

DIMENSIONS

| H | W | D |
|--------|--------|-------|
| 14-3/4 | 12-1/8 | 4-1/4 |



08575

SIEMENS
I-T-E® Electrical Products



83271



83277



83265

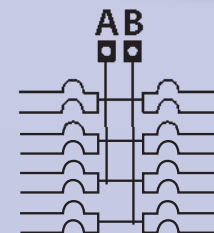

W0816ML1125CU
16-Poles Max.

SERVICE & INSTALLATION

Cartridge Fuses

MARS SERIES **820**



SERVICE & INSTALLATION

Cartridge Fuses, Type TRS

Time delay (class RK5, 600 volt)

| MARS NO. | DESCRIPTION | MARS PACK | CASE QTY. |
|----------|------------------------|-----------|-----------|
| 82103* | 2/10a - 600V, TRS fuse | 10 | 100 |
| 82106* | 1/2a - 600V, TRS fuse | 10 | 100 |
| 82109* | 1a - 600V, TRS fuse | 10 | 100 |
| 82110* | 1.6a - 600V, TRS fuse | 10 | 100 |
| 82111* | 2a - 600V, TRS fuse | 10 | 100 |
| 82112* | 2.25a - 600V, TRS fuse | 10 | 100 |
| 82124* | 5a - 600V, TRS fuse | 10 | 200 |
| 82125* | 6a - 600V, TRS fuse | 10 | 200 |
| 82132 | 10a - 600V, TRS fuse | 10 | 200 |
| 82133 | 12a - 600V, TRS fuse | 10 | 200 |
| 82134 | 15a - 600V, TRS fuse | 10 | 200 |
| 82136 | 20a - 600V, TRS fuse | 10 | 200 |
| 82137 | 25a - 600V, TRS fuse | 10 | 200 |
| 82138 | 30a - 600V, TRS fuse | 10 | 200 |
| 82139 | 35a - 600V, TRS fuse | 10 | 100 |
| 82140 | 40a - 600V, TRS fuse | 10 | 100 |
| 82147 | 45a - 600V, TRS fuse | 10 | 100 |
| 82141 | 50a - 600V, TRS fuse | 10 | 100 |
| 82142 | 60a - 600V, TRS fuse | 10 | 100 |
| 82143 | 70a - 600V, TRS fuse | 5 | 5 |
| 82144 | 80a - 600V, TRS fuse | 5 | 5 |
| 82145 | 90a - 600V, TRS fuse | 5 | 5 |
| 82146 | 100a - 600V, TRS fuse | 5 | 5 |
| 82154 | 110a - 600V, TRS fuse | 1 | 1 |
| 82148 | 125a - 600V, TRS fuse | 1 | 1 |
| 82149 | 150a - 600V, TRS fuse | 1 | 1 |
| 82150 | 175a - 600V, TRS fuse | 1 | 1 |
| 82151 | 200a - 600V, TRS fuse | 1 | 1 |
| 82152 | 250a - 600V, TRS fuse | 1 | 1 |
| 82153 | 300a - 600V, TRS fuse | 1 | 1 |

* NOTE: SmartSpot indicating fuse not available below 8 amps

Cartridge Fuses, Type TRS Clamshell Packaging For Merchandisers

Time delay (class RK5, 600 volt)

| MARS NO. | DESCRIPTION | MARS PACK | CASE QTY. |
|----------|-----------------------------|-----------|-----------|
| 82632 | 10a - 600V, (3 pk) TRS fuse | 1 | 1 |
| 82634 | 15a - 600V, (3 pk) TRS fuse | 1 | 1 |
| 82636 | 20a - 600V, (3 pk) TRS fuse | 1 | 1 |
| 82637 | 25a - 600V, (3 pk) TRS fuse | 1 | 1 |
| 82638 | 30a - 600V, (3 pk) TRS fuse | 1 | 1 |
| 82639 | 35a - 600V, (3 pk) TRS fuse | 1 | 1 |
| 82640 | 40a - 600V, (3 pk) TRS fuse | 1 | 1 |
| 82647 | 45a - 600V, (3 pk) TRS fuse | 1 | 1 |
| 82641 | 50a - 600V, (3 pk) TRS fuse | 1 | 1 |
| 82642 | 60a - 600V, (3 pk) TRS fuse | 1 | 1 |

Gen. Purpose Cartridge Fuses, Type OT

One-Time non-renewable, Class K-5

| MARS NO. | DESCRIPTION | MARS PACK | CASE QTY. |
|----------|-------------------------|-----------|-----------|
| 82210 | 10a - 250V, OT10 Fuse | 10 | 100 |
| 82212 | 15a - 250V, OT15 Fuse | 10 | 100 |
| 82213 | 20a - 250V, OT20 Fuse | 10 | 100 |
| 82214 | 25a - 250V, OT25 Fuse | 10 | 100 |
| 82215 | 30a - 250V, OT30 Fuse | 10 | 100 |
| 82216 | 35a - 250V, OT35 Fuse | 10 | 100 |
| 82217 | 40a - 250V, OT40 Fuse | 10 | 100 |
| 82218 | 45a - 250V, OT45 Fuse | 10 | 100 |
| 82219 | 50a - 250V, OT50 Fuse | 10 | 100 |
| 82220 | 60a - 250V, OT60 Fuse | 10 | 100 |
| 82221 | 70a - 250V, OT70 Fuse | 5 | 100 |
| 82224 | 100a - 250V, OT100 Fuse | 5 | 100 |

FERRAZ SHAWMUT IS NOW MERSEN

MERSEN



SmartSpot blown-fuse indicator

With SmartSpot you'll find the open fuse FAST. When a fuse opens, the SmartSpot indicator on the label of the fuse senses it and turns from SILVER to eye-catching RED.

And it stays RED so you can spot the open fuse quickly and safely.

Just open a panel and scan. Wherever you see any red in a SmartSpot indicator, you know the fuse is open.

This is a big advantage to contractors/service personnel because it helps them to identify very quickly what fuse needs to be changed thereby avoiding costly downtime.

You'll find SmartSpot on all of the most widely used industry standard fuses such as Class RK5, RK1, and Class J.



Cartridge Fuses

MARS SERIES **820**

Cartridge Fuses, Type TR

Time delay (class RK5, 250 volt)

| MARS NO. | DESCRIPTION | MARS PACK | CASE QTY. |
|----------|-----------------------|-----------|-----------|
| 82006* | 1/2a-250V, TR fuse | 10 | 100 |
| 82009* | 1a-250V, TR fuse | 10 | 100 |
| 82016* | 2a-250V, TR fuse | 10 | 100 |
| 82017* | 2 1/2a-250V, TR fuse | 10 | 100 |
| 82019* | 3a-250V, TR fuse | 10 | 100 |
| 82020* | 3 2/10a-250V, TR fuse | 10 | 100 |
| 82021* | 4a-250V, TR fuse | 10 | 100 |
| 82024* | 5a-250V, TR fuse | 10 | 100 |
| 82025* | 5 6/10a-250V, TR fuse | 10 | 100 |
| 82026* | 6a-250V, TR fuse | 10 | 100 |
| 82027* | 6 1/4a-250V, TR fuse | 10 | 100 |
| 82029* | 7a-250V, TR fuse | 10 | 100 |
| 82030 | 8a-250V, TR fuse | 10 | 100 |
| 82032 | 10a-250V, TR fuse | 10 | 100 |
| 82033 | 12a-250V, TR fuse | 10 | 100 |
| 82034 | 15a-250V, TR fuse | 10 | 100 |
| 82035 | 17 1/2a-250V, TR fuse | 10 | 100 |
| 82036 | 20a-250V, TR fuse | 10 | 100 |
| 82037 | 25a-250V, TR fuse | 10 | 100 |
| 82038 | 30a-250V, TR fuse | 10 | 100 |
| 82039 | 35a-250V, TR fuse | 10 | 100 |
| 82040 | 40a-250V, TR fuse | 10 | 100 |
| 82041 | 45a-250V, TR fuse | 10 | 100 |
| 82042 | 50a-250V, TR fuse | 10 | 100 |
| 82043 | 60a-250V, TR fuse | 10 | 100 |
| 82044 | 70a-250V, TR fuse | 5 | 100 |
| 82045 | 80a-250V, TR fuse | 5 | 100 |
| 82046 | 90a-250V, TR fuse | 5 | 100 |
| 82047 | 100a-250V, TR fuse | 5 | 100 |
| 82048 | 110a-250V, TR fuse | 1 | 1 |
| 82049 | 125a-250V, TR fuse | 1 | 1 |
| 82050 | 150a-250V, TR fuse | 1 | 1 |
| 82051 | 175a-250V, TR fuse | 1 | 1 |
| 82052 | 200a-250V, TR fuse | 1 | 1 |
| 82053 | 225a-250V, TR fuse | 1 | 1 |
| 82054 | 350a-250V, TR fuse | 1 | 1 |
| 82056 | 400a-250V, TR fuse | 1 | 1 |
| 82055 | 600a-250V, TR fuse | 1 | 1 |

* NOTE: SmartSpot indicating fuse not available below 8 amps

Cartridge Fuses, Type TR Clamshell Packaging For Merchandisers

Time delay (class RK5, 250 volt)

| MARS NO. | DESCRIPTION | MARS PACK | CASE QTY. |
|----------|----------------------------|-----------|-----------|
| 82532 | 10a - 250V, (3 pk) TR fuse | 1 | 1 |
| 82534 | 15a - 250V, (3 pk) TR fuse | 1 | 1 |
| 82536 | 20a - 250V, (3 pk) TR fuse | 1 | 1 |
| 82537 | 25a - 250V, (3 pk) TR fuse | 1 | 1 |
| 82538 | 30a - 250V, (3 pk) TR fuse | 1 | 1 |
| 82539 | 35a - 250V, (3 pk) TR fuse | 1 | 1 |
| 82540 | 40a - 250V, (3 pk) TR fuse | 1 | 1 |
| 82541 | 45a - 250V, (3 pk) TR fuse | 1 | 1 |
| 82542 | 50a - 250V, (3 pk) TR fuse | 1 | 1 |
| 82543 | 60a - 250V, (3 pk) TR fuse | 1 | 1 |



FERRAZ SHAWMUT IS NOW MERSEN

MERSEN



SmartSpot blown-fuse indicator

With SmartSpot you'll find the open fuse FAST. When a fuse opens, the SmartSpot indicator on the label of the fuse senses it and turns from SILVER to eye-catching RED.

And it stays RED so you can spot the open fuse quickly and safely.

Just open a panel and scan. Wherever you see any red in a SmartSpot indicator, you know the fuse is open.

This is a big advantage to contractors/service personnel because it helps them to identify very quickly what fuse needs to be changed thereby avoiding costly downtime.

You'll find SmartSpot on all of the most widely used industry standard fuses such as Class RK5, RK1, and Class J.

SERVICE & INSTALLATION

Midget & Specialty Fuses

MARS SERIES **820**



Midget Fast Acting Fuses, Type ATM

Fast acting

| MARS NO. | DESCRIPTION | MARS PACK | CASE QTY. |
|----------|-------------------------|-----------|-----------|
| 82907 | 1/2a - 600V, ATM fuse | 10 | 100 |
| 82909 | 1a - 600V, ATM fuse | 10 | 100 |
| 82910 | 1 1/2a - 600V, ATM fuse | 10 | 100 |
| 82911 | 2a - 600V, ATM fuse | 10 | 100 |
| 82916 | 3a - 600V, ATM fuse | 10 | 100 |
| 82912 | 4a - 600V, ATM fuse | 10 | 100 |
| 82913 | 5a - 600V, ATM fuse | 10 | 100 |
| 82914 | 6a - 600V, ATM fuse | 10 | 100 |
| 82918 | 7a - 600V, ATM fuse | 10 | 100 |
| 82915 | 8a - 600V, ATM fuse | 10 | 100 |
| 82917 | 10a - 600V, ATM fuse | 10 | 100 |
| 82919 | 15a - 600V, ATM fuse | 10 | 100 |
| 82920 | 20a - 600V, ATM fuse | 10 | 100 |
| 82922 | 30a - 600V, ATM fuse | 10 | 100 |

Specialty Fuses

| MARS NO. | DESCRIPTION | MARS PACK | CASE QTY. |
|----------|-------------|-----------|-----------|
|----------|-------------|-----------|-----------|

Small Dimension (Electronic) Fuses, 5 x 20mm — N. American Standards, Fast Acting

| | | | |
|-------|------------------|----|----|
| 82881 | GGM 2 250V fuse | 5 | 5 |
| 82879 | GGM .5 250V fuse | 5 | 5 |
| 82882 | GGM 10 250V fuse | 10 | 10 |

Small Time Delay Fuses, Rejection Style (PC Boards and small Dimension Fuses)

| | | | |
|-------|---------------------|---|-----|
| 82880 | GMQ 3.2a, 300V fuse | 5 | 100 |
| 82884 | GMQ4a, 300V fuse | 5 | 100 |

Fast Acting Size Rejection Special Type Fuse (PC Boards and small Dimension Fuses)

| | | | |
|-------|---------------------|---|-----|
| 82980 | GLQ 3.0a, 300V fuse | 5 | 100 |
|-------|---------------------|---|-----|

Fast Acting Non Rejecting Special Type Fuse (Low voltage supplementary fuses)

| | | | |
|-------|---------------------|---|-----|
| 82886 | GLR 1.5a, 300V fuse | 5 | 100 |
| 82887 | GLR 1.6a, 300V fuse | 5 | 100 |
| 82891 | GLR 10a, 300V fuse | 5 | 100 |
| 82890 | GLR 15a, 300V fuse | 5 | 100 |
| 82883 | GSC 1a, 300V fuse | 5 | 100 |

Slo Blo Fuses

| | | | |
|-------|------------------------|---|-----|
| 82439 | 3AB-326 1a, 250V fuse | 5 | 100 |
| 82442 | 3AB-326 5a, 250V fuse | 5 | 100 |
| 82445 | 3AB-326 15a, 250V fuse | 5 | 100 |
| 82444 | 3AB-326 20a, 250V fuse | 5 | 100 |

Time Delay, 1/4 x 1 1/4", Glass Type Fuses (PC Boards and small Dimension Fuses)

| | | | |
|-------|------------------|----|----|
| 82978 | WVR heat limiter | 10 | 10 |
| 82979 | WUR heat limiter | 10 | 10 |

Small Dimension Time Delay Non Rejecting Special Fuse (PC Boards and small Dimension Fuses)

| | | | |
|-------|---------------------|---|---|
| 82888 | SMF 3.2a, (LMF 3.2) | 5 | 5 |
|-------|---------------------|---|---|

FERRAZ SHAWMUT IS NOW MERSEN

MERSEN



| MARS NO. | DESCRIPTION | MARS PACK | CASE QTY. |
|----------|-------------|-----------|-----------|
|----------|-------------|-----------|-----------|

Low Voltage Supplementary Time Delay Fuse, 10X38 or 13/32 X 1-1/2 Size

| | | | |
|-------|--------------------|----|-----|
| 82956 | TRM .2a, 250V fuse | 10 | 100 |
| 82953 | TRM .8a, 250V fuse | 10 | 100 |
| 82958 | TRM 1a, 250V fuse | 10 | 100 |
| 82959 | TRM 2a, 250V fuse | 10 | 100 |
| 82960 | TRM 3a, 250V fuse | 10 | 100 |
| 82963 | TRM 4a, 250V fuse | 10 | 100 |
| 82965 | TRM 5a, 250V fuse | 10 | 100 |
| 82946 | TRM 6a, 250V fuse | 10 | 100 |
| 82954 | TRM 8a, 250V fuse | 10 | 100 |
| 82969 | TRM 10a, 250V fuse | 10 | 100 |
| 82970 | TRM 15a, 250V fuse | 10 | 100 |
| 82972 | TRM 20a, 250V fuse | 10 | 100 |
| 82973 | TRM 25a, 250V fuse | 10 | 100 |
| 82974 | TRM 30a, 250V fuse | 10 | 100 |

Low Voltage Branch Circuit Rated Fuses, R Class CC

| | | | |
|-------|----------------------|----|-----|
| 82977 | ATMR -2a, 600V fuse | 10 | 100 |
| 82966 | ATMR -3a, 600V fuse | 10 | 100 |
| 82967 | ATMR -4a, 600V fuse | 10 | 100 |
| 82971 | ATMR -10a, 600V fuse | 10 | 100 |
| 82976 | ATMR -12a, 600V fuse | 10 | 100 |
| 82968 | ATMR -15a, 600V fuse | 10 | 100 |
| 82981 | ATMR 20a, 600V fuse | 10 | 100 |

SERVICE & INSTALLATION



Cartridge & Midget Fuses

MARS SERIES **820**

Gen. Purpose Cartridge Fuses, Type OTS

One time non-renewable, Class K-5

| MARS NO. | DESCRIPTION | MARS PACK | CASE QTY. |
|----------|-----------------------|-----------|-----------|
| 82249 | 10a - 600V, OTS fuse | 10 | 100 |
| 82251 | 15a - 600V, OTS fuse | 10 | 100 |
| 82252 | 20a - 600V, OTS fuse | 10 | 100 |
| 82253 | 25a - 600V, OTS fuse | 10 | 100 |
| 82254 | 30a - 600V, OTS fuse | 10 | 100 |
| 82255 | 35a - 600V, OTS fuse | 10 | 100 |
| 82256 | 40a - 600V, OTS fuse | 10 | 100 |
| 82259 | 60a - 600V, OTS fuse | 10 | 100 |
| 82264 | 100a - 600V, OTS fuse | 5 | 100 |

Midget Fuses, Type OTM

Fast acting

| MARS NO. | DESCRIPTION | MARS PACK | CASE QTY. |
|----------|----------------------|-----------|-----------|
| 82702 | 2a - 250V, OTM fuse | 10 | 100 |
| 82705 | 5a - 250V, OTM fuse | 10 | 100 |
| 82710 | 15a - 250V, OTM fuse | 10 | 100 |
| 82711 | 20a - 250V, OTM fuse | 10 | 100 |

Midget Time Delay Fuses, Type ATQ

Time delay

| MARS NO. | DESCRIPTION | MARS PACK | CASE QTY. |
|----------|-----------------------|-----------|-----------|
| 82932 | 1/4a - 500V, ATQ fuse | 10 | 100 |
| 82933 | 1/2a - 500V, ATQ fuse | 10 | 100 |
| 82936 | 1a - 500V, ATQ fuse | 10 | 100 |
| 82941 | 2a - 500V, ATQ fuse | 10 | 100 |
| 82942 | 3a - 500V, ATQ fuse | 10 | 100 |
| 82943 | 4a - 500V, ATQ fuse | 10 | 100 |
| 82944 | 5a - 500V, ATQ fuse | 10 | 100 |
| 82945 | 6a - 500V, ATQ fuse | 10 | 100 |
| 82714 | 7a - 500V, ATQ fuse | 10 | 100 |
| 82947 | 10a - 500V, ATQ fuse | 10 | 100 |
| 82940 | 12a - 500V, ATQ fuse | 10 | 100 |
| 82952 | 15a - 500V, ATQ fuse | 10 | 100 |
| 82948 | 20a - 500V, ATQ fuse | 10 | 100 |
| 82949 | 25a - 500V, ATQ fuse | 10 | 100 |
| 82951 | 30a - 500V, ATQ fuse | 10 | 100 |

Midget Time Delay Fuse, Type ATQ Clamshell Packaging For Merchandisers

Time delay

| MARS NO. | DESCRIPTION | MARS PACK | CASE QTY. |
|----------|------------------------------|-----------|-----------|
| 82715 | 1a - 500V, (6 pk), ATQ fuse | 1 | 1 |
| 82716 | 3a - 500V, (6 pk), ATQ fuse | 1 | 1 |
| 82718 | 5a - 500V, (6 pk), ATQ fuse | 1 | 1 |
| 82719 | 10a - 500V, (6 pk), ATQ fuse | 1 | 1 |
| 82720 | 15a - 500V, (6 pk), ATQ fuse | 1 | 1 |
| 82721 | 20a - 500V, (6 pk), ATQ fuse | 1 | 1 |
| 82722 | 25a - 500V, (6 pk), ATQ fuse | 1 | 1 |
| 82723 | 30a - 500V, (6 pk), ATQ fuse | 1 | 1 |

FERRAZ SHAWMUT IS NOW MERSEN



SERVICE & INSTALLATION



The largest selection of motors, components and accessories for the HVAC/R Industry

Specialty Fuses & Fuse Display

MARS SERIES **820**



MARS HVACR Glass Fuse Display

| MARS NO. | DESCRIPTION | MARS PACK |
|----------|---|-----------|
| 82395 | Glass fuse assortment display-300 fuses | 1 |
| 82396 | Glass fuse display-empty | 1 |

Ceramic Body Fast Acting Fuses, Type GAB

| MARS NO. | DESCRIPTION | MARS PACK | CASE QTY. |
|----------|--------------------------------|-----------|-----------|
| 82403 | 1/2a -250V, GAB ceramic fuse | 5 | 5 |
| 82404 | 1a -250V, GAB ceramic fuse | 5 | 5 |
| 82402 | 1 1/2a -250V, GAB ceramic fuse | 5 | 5 |
| 82405 | 2a -250V, GAB ceramic fuse | 5 | 100 |
| 82406 | 2 1/2a -250V, GAB ceramic fuse | 5 | 5 |
| 82407 | 3a -250V, GAB ceramic fuse | 5 | 5 |
| 82408 | 4a -250V, GAB ceramic fuse | 5 | 5 |
| 82409 | 5a -250V, GAB ceramic fuse | 5 | 5 |
| 82410 | 6a -250V, GAB ceramic fuse | 5 | 5 |
| 82411 | 7a -250V, GAB ceramic fuse | 5 | 5 |
| 82412 | 8a -250V, GAB ceramic fuse | 5 | 5 |
| 82413 | 10a -250V, GAB ceramic fuse | 5 | 5 |
| 82414 | 12a -250V, GAB ceramic fuse | 5 | 5 |
| 82415 | 15a -250V, GAB ceramic fuse | 5 | 5 |
| 82416 | 20a -250V, GAB ceramic fuse | 5 | 5 |
| 82417 | 25a -250V, GAB ceramic fuse | 5 | 5 |
| 82418 | 30a -250V, GAB ceramic fuse | 5 | 5 |

Glass Body Non-Time Delay Fuses, Type GGC

| MARS NO. | DESCRIPTION | MARS PACK | CASE QTY. |
|----------|-------------------------------|-----------|-----------|
| 82448 | 1/10a -250V, GGC glass fuse | 5 | 5 |
| 82450 | 1/4a -250V, GGC glass fuse | 5 | 100 |
| 82451 | 3/10a -250V, GGC glass fuse | 5 | 5 |
| 82453 | 1/2a -250V, GGC glass fuse | 5 | 100 |
| 82455 | 3/4a -250V, GGC glass fuse | 5 | 5 |
| 82456 | 1a -250V, GGC glass fuse | 5 | 100 |
| 82457 | 1 1/4a -250V, GGC glass fuse | 5 | 5 |
| 82458 | 1 1/2a -250V, GGC glass fuse | 5 | 100 |
| 82460 | 2a -250V, GGC glass fuse | 5 | 100 |
| 82461 | 2 1/2a -250V, GGC glass fuse | 5 | 100 |
| 82462 | 3a -250V, GGC glass fuse | 5 | 100 |
| 82459 | 3 2/10a -250V, GGC glass fuse | 5 | 100 |
| 82463 | 4a -250V, GGC glass fuse | 5 | 100 |
| 82464 | 5a -250V, GGC glass fuse | 5 | 5 |
| 82465 | 6a -250V, GGC glass fuse | 5 | 100 |
| 82466 | 7 1/2a -250V, GGC glass fuse | 5 | 5 |
| 82467 | 8a -250V, GGC glass fuse | 5 | 100 |
| 82468 | 10a -250V, GGC glass fuse | 5 | 100 |
| 82474 | 12a -125V, GGC glass fuse | 5 | 100 |
| 82469 | 15a -125V, GGC glass fuse | 5 | 100 |
| 82471 | 20a -32V, GGC glass fuse | 5 | 100 |
| 82472 | 25a -32V, GGC glass fuse | 5 | 5 |
| 82473 | 30a -32V, GGC glass fuse | 5 | 5 |

Electronic/Glass Fuses, Type GGX

Fast acting 1/4" x 1"

| MARS NO. | DESCRIPTION | MARS PACK | CASE QTY. |
|----------|-----------------------------|-----------|-----------|
| 82878 | .4a -250V, GGX glass fuse | 5 | 5 |
| 82470 | 2/10a -250V, GGX glass fuse | 5 | 5 |
| 82484 | 1/2a -250V, GGX glass fuse | 5 | 100 |
| 82486 | 1a -250V, GGX glass fuse | 5 | 100 |
| 82488 | 2a -250V, GGX glass fuse | 5 | 5 |
| 82491 | 5a -125V, GGX glass fuse | 5 | 5 |
| 82877 | 3a -125V, GGX glass fuse | 5 | 5 |

FERRAZ SHAWMUT IS NOW MERSEN

MERSEN



82395



82403



82448

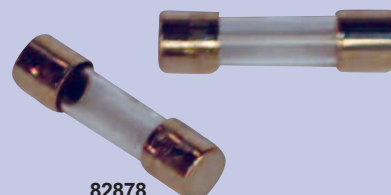

82878

SERVICE & INSTALLATION



Specialty Fuses

MARS SERIES **820**

Specialty Fuses (Cont.)

| MARS NO. | DESCRIPTION | MARS PACK | CASE QTY. |
|---|----------------------------------|-----------|-----------|
| Low Voltage Supplementary Fast Acting Fuses | | | |
| 82608 | BLS/BBS 1a, 250V fuse | 10 | 100 |
| 82609 | BLS/BBS 2a, 250V fuse | 10 | 100 |
| 82610 | BLS/BBS 3a, 250V fuse | 10 | 100 |
| 82611 | BLS/BBS 4a, 600V fuse | 10 | 100 |
| 82612 | BLS/BBS 5a, 600V fuse | 10 | 100 |
| Medium Voltage Fuses Class J Fast Acting | | | |
| 82158 | A4J -6a, 600V fuse | 10 | 100 |
| 82160 | A4J -15a, 600V fuse | 10 | 100 |
| 82161 | A4J -20a, 600V fuse | 10 | 100 |
| 82163 | A4J -30a, 600V fuse | 10 | 100 |
| 82169 | A3T -40a, 600V fuse | 10 | 100 |
| 82170 | A6T -25a, 600V fuse | 10 | 100 |
| 82179 | A6T -30a, 600V fuse | 10 | 100 |
| 82181 | A6T -35a, 600V fuse | 10 | 100 |
| 82182 | A6T -60a, 600V fuse | 10 | 100 |
| 82964 | RFS -40a, 600V fuse | 10 | 100 |
| Fuse Reducer | | | |
| 82975 | 263M/H632 fuse reducer(1 pair) | 1 | 10 |
| Automotive Blade Type Fuse Acting 32V DC | | | |
| 82230 | ATC-3a, auto blade fuse(5 pk) | 1 | 5 |
| 82232 | ATC -4a, auto blade fuse | 5 | 5 |
| 82231 | ATC -5a, auto blade fuse (5 pk) | 1 | 5 |
| 82233 | ATC -7.5a, auto blade fuse | 1 | 5 |
| 82234 | ATC -10a, auto blade fuse | 5 | 5 |
| 82235 | ATC -15a, auto blade fuse | 5 | 5 |
| 82236 | ATC -20a, auto blade fuse | 5 | 5 |
| 82237 | ATC -25a, auto blade fuse | 5 | 5 |
| 82238 | ATC -30a, auto blade fuse | 5 | 5 |
| ATDR Time Delay Class CC (Small motors, Contactors, Branch Circuit Protection) | | | |
| 82226 | ATDR -6.25a, 600V fuse, class CC | 10 | 10 |
| 82228 | ATDR-10a, 600V fuse | 10 | 10 |
| ATQR Time Delay Class CC (Control Transformers, Solenoids, Inductive Loads) | | | |
| 82227 | ATQR -15a, 600V fuse | 10 | 10 |

Class G Fuses 480 Volt, 600 Volt Type AG = Type SC

Time delay (above 5A) current limiting

| MARS NO. | DESCRIPTION | MARS PACK | CASE QTY. |
|----------|--------------------|-----------|-----------|
| 82271 | 1a -600V, AG fuse | 4 | 100 |
| 82290 | 2a -600V, AG fuse | 4 | 100 |
| 82272 | 3a -600V, AG fuse | 4 | 100 |
| 82291 | 4a -600V, AG fuse | 4 | 100 |
| 82273 | 5a -600V, AG fuse | 4 | 100 |
| 82274 | 6a -600V, AG fuse | 4 | 100 |
| 82275 | 8a -600V, AG fuse | 4 | 100 |
| 82276 | 10a -600V, AG fuse | 4 | 100 |
| 82278 | 15a -600V, AG fuse | 4 | 100 |
| 82279 | 20a -600V, AG fuse | 4 | 100 |
| 82280 | 25a -480V, AG fuse | 4 | 100 |
| 82281 | 30a -480V, AG fuse | 4 | 100 |
| 82282 | 35a -480V, AG fuse | 2 | 100 |
| 82283 | 40a -480V, AG fuse | 2 | 100 |
| 82285 | 50a -480V, AG fuse | 2 | 100 |
| 82286 | 60a -480V, AG fuse | 2 | 100 |



FERRAZ SHAWMUT IS NOW MERSEN

MERSEN

SERVICE & INSTALLATION

Glass Body Time Delay Fuses, Type GDL

Time delay 1/4" x 1 1/4"

| MARS NO. | DESCRIPTION | MARS PACK | CASE QTY. |
|----------|----------------------------|-----------|-----------|
| 82502 | 1a -250V, GDL glass fuse | 5 | 100 |
| 82505 | 1.5a -250V, GDL glass fuse | 5 | 100 |
| 82507 | 2a -250V, GDL glass fuse | 5 | 100 |
| 82508 | 2.5a -250V, GDL glass fuse | 5 | 100 |
| 82510 | 3a -250V, GDL glass fuse | 5 | 100 |
| 82512 | 4a -250V, GDL glass fuse | 5 | 100 |
| 82513 | 5a -250V, GDL glass fuse | 5 | 100 |
| 82514 | 7a -250V, GDL glass fuse | 5 | 100 |
| 82517 | 8a -250V, GDL glass fuse | 5 | 100 |
| 82518 | 10a -125V, GDL glass fuse | 5 | 100 |
| 82519 | 15a -125V, GDL glass fuse | 5 | 100 |



The largest selection of motors, components and accessories for the HVAC/R Industry

Glass & Plug Fuses

MARS SERIES **820**



Dual Element, Time Delay (Type S) UL 125V

Plug fuses all UL listed; CSA models also listed

Rejection Time delay, tamper resistant

| MARS NO. | DESCRIPTION | MARS PACK | CASE QTY. |
|----------|----------------------|-----------|-----------|
| 82307 | 1 1/4a, S plug fuse | 4 | 100 |
| 82308 | 1 6/10a, S plug fuse | 4 | 100 |
| 82311 | 2a, S plug fuse | 4 | 100 |
| 82313 | 2 1/2a, S plug fuse | 4 | 100 |
| 82315 | 3a, S plug fuse | 4 | 100 |
| 82316 | 3 2/10a, S plug fuse | 4 | 100 |
| 82318 | 4a, S plug fuse | 4 | 100 |
| 82320 | 5a, S plug fuse | 4 | 100 |
| 82323 | 6 1/4a, S plug fuse | 4 | 100 |
| 82325 | 8a, S plug fuse | 4 | 100 |
| 82326 | 9a, S plug fuse | 4 | 100 |
| 82327 | 10a, S plug fuse | 4 | 100 |
| 82328 | 12a, S plug fuse | 4 | 100 |
| 82330 | 15a, S plug fuse | 4 | 100 |
| 82331 | 20a, S plug fuse | 4 | 100 |
| 82332 | 25a, S plug fuse | 4 | 100 |
| 82333 | 30a, S plug fuse | 4 | 100 |

Dual Element Time Delay Fuse-Type S Clamshell Packaging For Merchandisers

Rejection Time delay, tamper resistant

| MARS NO. | DESCRIPTION | MARS PACK |
|----------|--------------------------------|-----------|
| 82745 | 15 a, S plug fuse 125V, (6 pk) | 1 |
| 82746 | 20 a, S plug fuse 125V, (6 pk) | 1 |
| 82747 | 25 a, S plug fuse 125V, (6 pk) | 1 |
| 82748 | 30 a, S plug fuse 125V, (6 pk) | 1 |

Dual Element, Time Delay (Type T) UL 125V

| MARS NO. | DESCRIPTION | MARS PACK | CASE QTY. |
|----------|-----------------------|-----------|-----------|
| 82334 | 1 1/4a, T plug fuse | 4 | 100 |
| 82337 | 2a, T plug fuse | 4 | 100 |
| 82344 | 2.5a, T plug fuse | 4 | 100 |
| 82338 | 3.2a, T plug fuse | 4 | 100 |
| 82339 | 4a, T plug fuse | 4 | 100 |
| 82340 | 5a, T plug fuse | 4 | 100 |
| 82341 | 6 1/4a, T plug fuse | 4 | 100 |
| 82342 | 8a, T plug fuse | 4 | 100 |
| 82343 | 10a, T plug fuse | 4 | 100 |
| 82660 | 15a, T plug fuse GT15 | 4 | 100 |
| 82661 | 20a, T plug fuse GT20 | 4 | 100 |
| 82662 | 30a, T plug fuse GT30 | 4 | 100 |
| 82663 | 25a, T plug fuse GT25 | 4 | 100 |

Dual Element, Time Delay (Type TL) UL 125V

| MARS NO. | DESCRIPTION | MARS PACK | CASE QTY. |
|----------|-------------------|-----------|-----------|
| 82346 | 15a, TL plug fuse | 4 | 100 |
| 82347 | 20a, TL plug fuse | 4 | 100 |
| 82348 | 25a, TL plug fuse | 4 | 100 |
| 82349 | 30a, TL plug fuse | 4 | 100 |

FERRAZ SHAWMUT IS NOW MERSEN

MERSEN

82308



82337



82350



82735



Dual Element, Time Delay (Type TD) UL 125V

| MARS NO. | DESCRIPTION | MARS PACK | CASE QTY. |
|----------|-----------------------|-----------|-----------|
| 82350 | 15a, TD plug fuse-CSA | 4 | 100 |
| 82351 | 20a, TD plug fuse-CSA | 4 | 100 |
| 82352 | 25a, TD plug fuse-CSA | 4 | 100 |
| 82353 | 30a, TD plug fuse-CSA | 4 | 100 |

Dual Element Time Delay Fuse-Type TL Clamshell Packaging For Merchandisers

| MARS NO. | DESCRIPTION | MARS PACK |
|----------|---------------------------------|-----------|
| 82735 | 15 a, 125V, TL plug fuse (6 pk) | 1 |
| 82736 | 20 a, 125V, TL plug fuse (6 pk) | 1 |
| 82737 | 25 a, 125V, TL plug fuse (6 pk) | 1 |
| 82738 | 30 a, 125V, TL plug fuse (6 pk) | 1 |

SERVICE & INSTALLATION



Plug Fuses

MARS SERIES **820**

S Plug Fuse Adapters, UL 125

| MARS NO. | DESCRIPTION | MARS PACK | CASE QTY. |
|----------|----------------------|-----------|-----------|
| 82375 | 2 1/2a, S plug fuse | 4 | 100 |
| 82376 | 3 2/10a, S plug fuse | 4 | 100 |
| 82379 | 6 1/4a, S plug fuse | 4 | 100 |
| 82382 | 15a, S plug fuse | 4 | 100 |
| 82383 | 20a, S plug fuse | 4 | 100 |
| 82384 | 30a, S plug fuse | 4 | 100 |

Fast Acting, (Type W) UL 125V

| MARS NO. | DESCRIPTION | MARS PACK | CASE QTY. |
|----------|------------------|-----------|-----------|
| 82360 | 10a, W plug fuse | 4 | 100 |
| 82363 | 15a, W plug fuse | 4 | 100 |
| 82364 | 20a, W plug fuse | 4 | 100 |
| 82365 | 25a, W plug fuse | 4 | 100 |
| 82366 | 30a, W plug fuse | 4 | 100 |

Dual Element, Time Delay Fuse - Type W Clamshell Packaging For Merchandisers

| MARS NO. | DESCRIPTION | MARS PACK |
|----------|-------------------------------|-----------|
| 82755 | 15a, 125V, W plug fuse (6 pk) | 1 |
| 82756 | 20a, 125V, W plug fuse (6 pk) | 1 |
| 82757 | 25a, 125V, W plug fuse (6 pk) | 1 |
| 82758 | 30a, 125V, W plug fuse (6 pk) | 1 |

"W" Fuse

FERRAZ SHAWMUT IS NOW MERSEN

MERSEN



Fuse Adapters



SERVICE & INSTALLATION



Fuse Blocks

MARS SERIES **820**

Fuse Blocks - Class H & K 250 Volts

Mersen manufactures the highest quality 250 to 600 volt fuse blocks handling current capacities of 30 to 600 amperes. These durable fuse blocks are designed for class H, J, K, R, CC and Midget fuses. All blocks are UL listed and CSA certified.

Mersen fuse blocks feature a unique adder block which can be snapped on to form multi-pole segmented blocks of as many poles as desired. Multiple pole blocks thus formed save valuable space, are permanent, and can be added to in the future.

Fuse block insulators are constructed of either phenolic or molded polycarbonate. Three types of wire connectors are used. Screw type is for copper wire with terminals. Pressure plate type is for bare copper wire where vibration may be a factor. Box type connectors are the most durable and versatile for stranded or solid wire. All fuse clips are one piece high-conductivity tin-plated copper for low resistance connections and cool operation.

| MARS NO. | DESCRIPTION | MARS PACK | CASE QTY. |
|----------|------------------------|-----------|-----------|
| 83010 | Adder 30 amp - Al box | 1 | 50 |
| 83011 | 1 pole 30 amp - Al box | 1 | 50 |
| 83012 | 1 pole 30 amp - screw | 1 | 50 |
| 83013 | 2 pole 30 amp - screw | 1 | 50 |
| 83015 | Adder 60 amp - Al box | 1 | 50 |
| 83017 | 2 pole 60 amp - Al box | 1 | 25 |
| 83018 | 3 pole 60 amp - Al box | 1 | 25 |

FERRAZ SHAWMUT IS NOW MERSEN

MERSEN

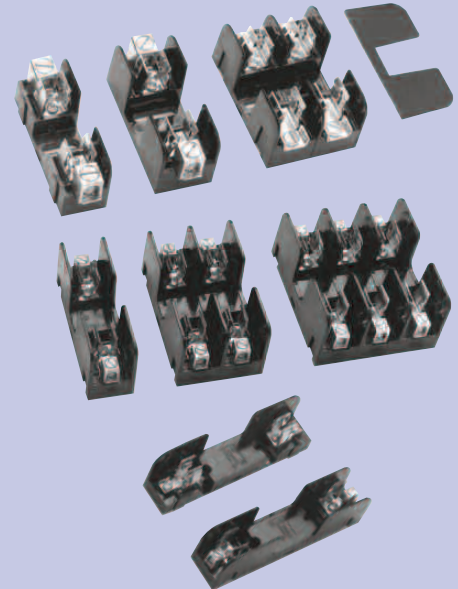

The largest selection of motors, components and accessories for the HVAC/R Industry

Fuse & Power Blocks

MARS SERIES **820**



SERVICE & INSTALLATION

Fuse Blocks - Midget Fuses 600 Volts

Mersen power distribution blocks (pdb), afford a safe, convenient way of splicing cables, splitting primary power into a variety of secondary circuits or providing a fixed junction tap - off point. Insulators are virtually unbreakable polycarbonate. Standard aluminum box connectors accommodate aluminum and copper wire. Connector bars are all one piece and tin plated. The pdbs are UL listed and CSA certified.

| MARS NO. | DESCRIPTION | MARS PACK | CASE QTY. |
|----------|-----------------------|-----------|-----------|
| 83061 | 1 pole 30 amp - screw | 1 | 50 |
| 83062 | 2 pole 30 amp - screw | 1 | 25 |
| 83063 | 3 pole 30 amp - screw | 1 | 25 |
| 83065 | 1 pole 30 amp - plate | 1 | 50 |
| 83066 | 2 pole 30 amp - plate | 1 | 25 |
| 83067 | 3 pole 30 amp - plate | 1 | 25 |

Power Distribution Blocks - 600 Volts

| MARS NO. | DESCRIPTION | MARS PACK | CASE QTY. |
|----------|----------------------------|-----------|-----------|
| 83090 | 1 pole pdb 1 to 4 #4-#14ga | 1 | 50 |
| 83091 | 2 pole pdb 1 to 4 #4-#14ga | 1 | 25 |
| 83092 | 3 pole pdb 1 to 4 #4-#14ga | 1 | 25 |

Fuse Holders

| MARS NO. | DESCRIPTION | MARS PACK | CASE QTY. |
|----------|---|-----------|-----------|
| 82994 | panel mount glass holder 1/4" x 1 1/4" screw type knob | 1 | 100 |
| 82995 | panel mount midget holder 13/32" x 1 1/2" bayonet knob | 1 | 100 |
| 82996 | base mount glass fuse block 1/4" x 1 1/4" | 10 | 100 |
| 82997 | in-line midget holder-screw cap | 1 | 100 |
| 83001 | in-line glass holder-screw cap (5 pk) | 1 | 100 |
| 83002 | in-line glass holder-snap cap (5 pk) | 1 | 100 |
| 82987 | HPF-EE fuse holder | 10 | 100 |
| 82989 | HPF-SC fuse holder-panel mount | 10 | 100 |
| 82990 | HHB fuse holder | 10 | 100 |
| 82991 | HKP-HH fuse holder | 1 | 10 |
| 82993 | HRK fuse holder | 10 | 100 |

FERRAZ SHAWMUT IS NOW MERSEN

MERSEN

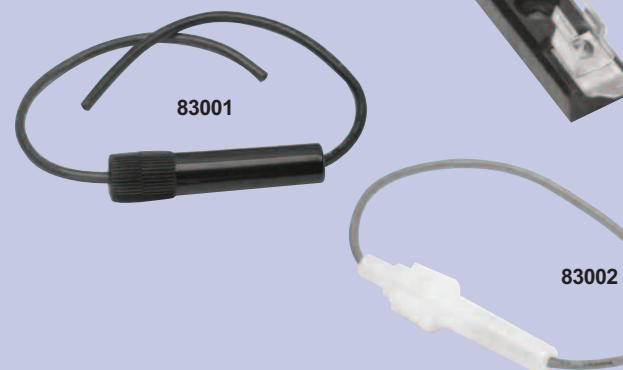
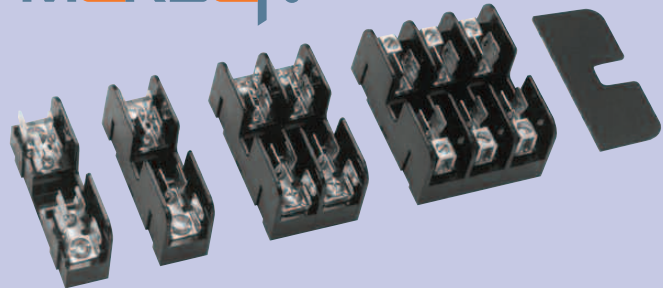



JARD Fuses

Applications:

- Recommended for AC power distribution system mains, feeders, and branch circuits.
- Protection of motors and motor branch circuits.
- Protection of transformers and other inductive loads.
- All general-purpose applications including lighting, heating and other non-inductive loads.

Benefits:

- Superior overload and cycling capabilities.
- Current limiting provides component short-circuit protection.

Specifications:

Dual-Element Time-Delay

Voltage Rating: RK5 - 250Vac, RK5 - 600Vac

Amp Rating: 1/10 - 600A

Interrupting Rating: 200,000 RMS Symmetrical Amps

Current Limiting: RK5 Fuse

Agency Approvals:

UL Listed, Class RK5, CSA Certified, DC listed to UL standard 248 TRS only

Voltage Rating: RK5 250V

- Volts: 250VAC
- : 250VDC (.1-2.8A; 35-400A)
- : 160VDC (3-30A; 450-600A)

RK5 600V

- Volts: 600VAC
- : 600VDC (.1-12A; 70-600A)
- : 160VDC (15-60A)

RK5 Time Delay Fuse 250V

Replaces: TR, ECNR, FRNR, FLNR

| MARS NO. | DESCRIPTION | MARS PACK |
|----------|-------------|-----------|
| 81006 | .5A - 250V | 10 |
| 81009 | 1A -250V | 10 |
| 81016 | 2A - 250V | 10 |
| 81017 | 2.5A - 250V | 10 |
| 81019 | 3A - 250V | 10 |
| 81020 | 3.2A - 250V | 10 |
| 81021 | 4A - 250V | 10 |
| 81024 | 5A - 250V | 10 |
| 81025 | 5.6A - 250V | 10 |
| 81026 | 6A -250V | 10 |
| 81027 | 6.25A -250V | 10 |
| 81029 | 7A -250V | 10 |
| 81030 | 8A -250V | 10 |
| 81032 | 10A -250V | 10 |
| 81033 | 12A -250V | 10 |
| 81034 | 15A -250V | 10 |
| 81035 | 17.5A -250V | 10 |
| 81036 | 20A - 250V | 10 |
| 81037 | 25A -250V | 10 |
| 81038 | 30A -250V | 10 |
| 81039 | 35A -250V | 10 |
| 81040 | 40A -250V | 10 |
| 81041 | 45A -250V | 10 |
| 81042 | 50A -250V | 10 |
| 81043 | 60A -250V | 10 |
| 81044 | 70A -250V | 5 |
| 81045 | 80A -250V | 5 |
| 81046 | 90A -250V | 5 |
| 81047 | 100A -250V | 5 |
| 81048 | 110A -250V | 1 |
| 81049 | 125A -250V | 1 |
| 81050 | 150A -250V | 1 |
| 81051 | 175A -250V | 1 |
| 81052 | 200A -250V | 1 |
| 81053 | 225A -250V | 1 |
| 81054 | 350A -250V | 1 |
| 81056 | 400A -250V | 1 |
| 81055 | 600A -250V | 1 |

RK5 Time Delay Fuse 600V

Replaces: TRS, ECSR, FRSR, FLSR

| MARS NO. | DESCRIPTION | MARS PACK |
|----------|-------------|-----------|
| 81103 | .2A -600V | 10 |
| 81106 | .5A -600V | 10 |
| 81109 | 1A -600V | 10 |
| 81110 | 1.6A -600V | 10 |
| 81111 | 2A -600V | 10 |
| 81112 | 2.25A -600V | 10 |
| 81077 | 4A -600V | 10 |
| 81124 | 5A -600V | 10 |
| 81125 | 6A -600V | 10 |
| 81078 | 8A - 600V | 10 |
| 81132 | 10A -600V | 10 |
| 81133 | 12A -600V | 10 |
| 81134 | 15A -600V | 10 |
| 81076 | 17.5A -600V | 10 |
| 81136 | 20A -600V | 10 |
| 81137 | 25A -600V | 10 |
| 81138 | 30A -600V | 10 |
| 81139 | 35A -600V | 10 |
| 81140 | 40A -600V | 10 |
| 81147 | 45A -600V | 10 |
| 81141 | 50A -600V | 10 |
| 81142 | 60A -600V | 10 |
| 81143 | 70A -600V | 5 |
| 81144 | 80A -600V | 5 |
| 81145 | 90A -600V | 5 |
| 81146 | 100A -600V | 5 |
| 81154 | 110A -600V | 1 |
| 81148 | 125A -600V | 1 |
| 81149 | 150A -600V | 1 |
| 81150 | 175A -600V | 1 |
| 81151 | 200A -600V | 1 |
| 81152 | 250A -600V | 1 |
| 81153 | 300A -600V | 1 |



SERVICE & INSTALLATION

Edison Fuses

MARS SERIES **810**



JDL Time Delay Fuses - Class J

UL Fuses: Current Limiting

| MARS NO. | DESCRIPTION | MARS PACK |
|----------|-----------------------------|-----------|
| 81621 | 7 A 600V Fuse Time Dly CL-J | 10 |
| 81613 | 10A 600V Fuse Time Dly CL-J | 10 |
| 81614 | 15A 600V Fuse Time Dly CL-J | 10 |
| 81615 | 20A 600V Fuse Time Dly CL-J | 10 |
| 81616 | 30A 600V Fuse Time Dly CL-J | 10 |
| 81617 | 35A 600V Fuse Time Dly CL-J | 10 |
| 81618 | 40A 600V Fuse Time Dly CL-J | 10 |
| 81619 | 45A 600V Fuse Time Dly CL-J | 10 |
| 81620 | 60A 600V Fuse Time Dly CL-J | 10 |
| 81622 | 80A 600V Fuse Time Dly CL-J | 5 |

JFL Fast-Acting Fuses - Class J

UL Fuses: Current Limiting

| MARS NO. | DESCRIPTION | MARS PACK |
|----------|---------------------------------|-----------|
| 81158 | 6A UL CLASS J Fast Acting 600V | 10 |
| 81160 | 15A UL CLASS J Fast Acting 600V | 10 |
| 81161 | 20A UL CLASS J Fast Acting 600V | 10 |
| 81163 | 30A UL CLASS J Fast Acting 600V | 10 |
| 81623 | 70A UL CLASS J Fast Acting 600V | 5 |

TJN (300Vac) Class T Extremely Fast-Acting Fuses

UL Fuses: Current Limiting

Compact, space saving size. These fuses are ideal as the main fuse protection for panelboards, load centers and meter stacks.

| MARS NO. | DESCRIPTION | MARS PACK |
|----------|-----------------------------------|-----------|
| 81664 | 30A TJN Fast Acting 300V Class T | 10 |
| 81665 | 60A TJN Fast Acting 300V Class T | 10 |
| 81663 | 150A TJN Fast Acting 300V Class T | 1 |

TJS (600Vac) Class T Extremely Fast-Acting Fuses

UL Fuses: Current Limiting

Compact, space saving size. These fuses are ideal as the main fuse protection for panelboards, load centers and meter stacks.

| MARS NO. | DESCRIPTION | MARS PACK |
|----------|----------------------------------|-----------|
| 81666 | 10A TJSFast Acting 600V Class T | 10 |
| 81668 | 15A TJS Fast Acting 600V Class T | 10 |
| 81669 | 40A TJSFast Acting 600V Class T | 10 |
| 81670 | 45A TJSFast Acting 600V Class T | 10 |
| 81671 | 50A TJSFast Acting 600V Class T | 10 |
| 81672 | 70A TJSFast Acting 600V Class T | 5 |
| 81673 | 80A TJSFast Acting 600V Class T | 5 |
| 81674 | 90A TJSFast Acting 600V Class T | 5 |
| 81667 | 100A TJSFast Acting 600V Class T | 5 |

SEC Fast Acting & Time Delay - Class G Fuse

UL Fuses: Current Limiting

| MARS NO. | DESCRIPTION | MARS PACK |
|----------|--------------------------------|-----------|
| 81271 | 1A UL CLASS GTime Delay 600V | 10 |
| 81290 | 2A UL CLASS G Time Delay 600V | 10 |
| 81272 | 3A UL CLASS G Time Delay 600V | 10 |
| 81273 | 5A UL CLASS G Time Delay 600V | 10 |
| 81274 | 6A UL CLASS G Time Delay 600V | 10 |
| 81275 | 8A UL CLASS G Time Delay 600V | 10 |
| 81276 | 10A UL CLASS G Time Delay 600V | 10 |
| 81278 | 15A UL CLASS G Time Delay 600V | 10 |
| 81279 | 20A UL CLASS G Time Delay 600V | 10 |
| 81280 | 25A UL CLASS G Time Delay 480V | 10 |
| 81281 | 30A UL CLASS G Time Delay 480V | 10 |
| 81282 | 35A UL CLASS G Time Delay 480V | 10 |
| 81283 | 40A UL CLASS G Time Delay 480V | 10 |
| 81285 | 50A UL CLASS G Time Delay 480V | 10 |
| 81286 | 60A UL CLASS G Time Delay 480V | 10 |

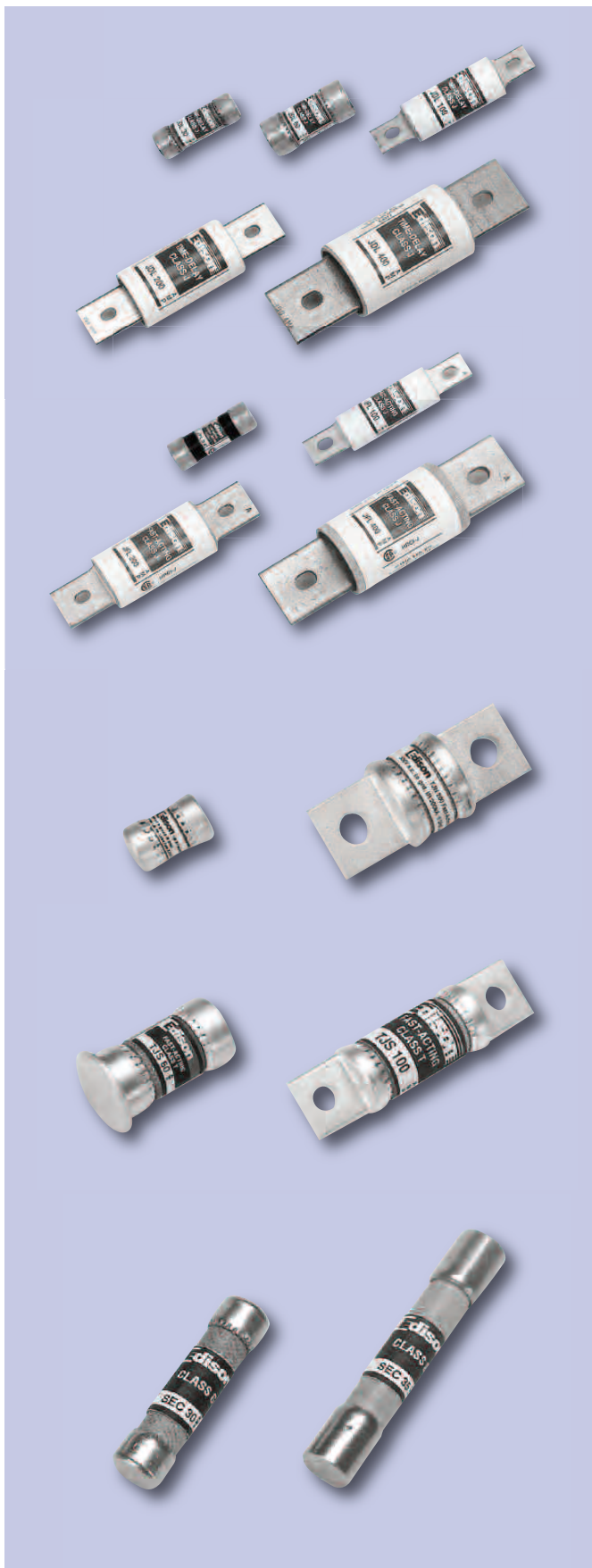

SERVICE & INSTALLATION



MOL Midget Fuses, Fast-Acting

UL Fuses: General Purpose (13/32" x 1 1/2")

| MARS NO. | DESCRIPTION | MARS PACK |
|----------|-------------------------------------|-----------|
| 81702 | 2A UL MOL Fast Act Midget Fus 250V | 10 |
| 81705 | 5A UL MOL Fast Act Midget Fus 250V | 10 |
| 81710 | 15A UL MOL Fast Act Midget Fus 250V | 10 |
| 81711 | 20A UL MOL Fast Act Midget Fus 250V | 10 |

EBS Midget Fuses, Fast-Acting

UL Fuses: General Purpose (13/32" x 1 1/2")

| MARS NO. | DESCRIPTION | MARS PACK |
|----------|-------------------------------------|-----------|
| 81608 | 1A UL EBS Fast Act Midget Fuse 600V | 10 |
| 81609 | 2A UL EBS Fast Act Midget Fuse 600V | 10 |
| 81610 | 3A UL EBS Fast Act Midget Fuse 600V | 10 |
| 81611 | 4A UL EBS Fast Act Midget Fuse 600V | 10 |
| 81612 | 5A UL EBS Fast Act Midget Fuse 600V | 10 |

MEN Midget Fuses, Time Delay

UL Fuses: General Purpose (13/32" x 1 1/2")

| MARS NO. | DESCRIPTION | MARS PACK |
|----------|---------------------------------------|-----------|
| 81956 | .2A UL MEN Time Dly Midget Fuse 250V | 10 |
| 81953 | .8A UL MEN Time Dly Midget Fuse 250V | 10 |
| 81958 | 1A UL MEN Time Dly Midget Fuse 250V | 10 |
| 81959 | 2A UL MEN Time Dly Midget Fuse 250V | 10 |
| 81960 | 3A UL MEN Time Dly Midget Fuse 250V | 10 |
| 81644 | 3.2A UL MEN Time Dly Midget Fuse 250V | 10 |
| 81963 | 4A UL MEN Time Dly Midget Fuse 250V | 10 |
| 81965 | 5A UL MEN Time Dly Midget Fuse 250V | 10 |
| 81946 | 6A UL MEN Time Dly Midget Fuse 250V | 10 |
| 81954 | 8A UL MEN Time Dly Midget Fuse 250V | 10 |
| 81969 | 10A UL MEN Time Dly Midget Fuse 250V | 10 |
| 81970 | 15A UL MEN Time Dly Midget Fuse 250V | 10 |
| 81972 | 20A UL MEN Time Dly Midget Fuse 250V | 10 |
| 81973 | 25A UL MEN Time Dly Midget Fuse 250V | 10 |
| 81974 | 30A UL MEN Time Dly Midget Fuse 250V | 10 |

MEQ Midget Fuses, Time Delay

UL Fuses: General Purpose (13/32" x 1 1/2")

| MARS NO. | DESCRIPTION | MARS PACK |
|----------|--|-----------|
| 81645 | .1A UL MEQ Time Dly Midget Fuse 500V | 10 |
| 81932 | .25A UL MEQ Time Dly Midget Fuse 500V | 10 |
| 81933 | .5A UL MEQ Time Dly Midget Fuse 500V | 10 |
| 81646 | .6A UL MEQ Time Dly Midget Fuse 500V | 10 |
| 81936 | 1A UL MEQ Time Dly Midget Fuse 500V | 10 |
| 81648 | 1.5A UL MEQ Time Dly Midget Fuse 500V | 10 |
| 81941 | 2A UL MEQ Time Dly Midget Fuse 500V | 10 |
| 81649 | 2.5A UL MEQ Time Dly Midget Fuse 500V | 10 |
| 81942 | 3A UL MEQ Time Dly Midget Fuse 500V | 10 |
| 81650 | 3.2A UL MEQ Time Dly Midget Fuse 500V | 10 |
| 81651 | 3.5A UL MEQ Time Dly Midget Fuse 500V | 10 |
| 81943 | 4A UL MEQ Time Dly Midget Fuse 500V | 10 |
| 81944 | 5A UL MEQ Time Dly Midget Fuse 500V | 10 |
| 81945 | 6A UL MEQ Time Dly Midget Fuse 500V | 10 |
| 81653 | 6.25A UL MEQ Time Dly Midget Fuse 500V | 10 |
| 81714 | 7A UL MEQ Time Dly Midget Fuse 500V | 10 |
| 81654 | 8A UL MEQ Time Dly Midget Fuse 500V | 10 |
| 81947 | 10A UL MEQ Time Dly Midget Fuse 500V | 10 |
| 81940 | 12A UL MEQ Time Dly Midget Fuse 500V | 10 |
| 81952 | 15A UL MEQ Time Dly Midget Fuse 500V | 10 |
| 81948 | 20A UL MEQ Time Dly Midget Fuse 500V | 10 |
| 81949 | 25A UL MEQ Time Dly Midget Fuse 500V | 10 |
| 81951 | 30A UL MEQ Time Dly Midget Fuse 500V | 10 |



81710



81612



81969



81951

Edison Fuses

MARS SERIES **810**



SERVICE & INSTALLATION

EDCC Time-Delay CLASS CC Fuses

UL Fuses: Current Limiting

| MARS NO. | DESCRIPTION | MARS PACK |
|----------|--------------------------|-----------|
| 81079 | 1/2A 600V T/D Class CC | 10 |
| 81080 | 1A 600V T/D Class CC | 10 |
| 81081 | 1.5A 600V T/D Class CC | 10 |
| 81086 | 3A 600V T/D Class CC | 10 |
| 81097 | 3-1/2A 600V T/D Class CC | 10 |
| 81088 | 4A 600V T/D Class CC | 10 |
| 81089 | 5A 600V T/D Class CC | 10 |
| 81093 | 5 6/10 600V T/D Class CC | 10 |
| 81094 | 6A 600V T/D Class CC | 10 |
| 81095 | 7 A 600V T/D Class CC | 10 |
| 81096 | 8A 600V T/D Class CC | 10 |
| 81228 | 10A 600V T/D Class CC | 10 |
| 81082 | 15A 600V T/D Class CC | 10 |
| 81083 | 20A 600V T/D Class CC | 10 |
| 81084 | 25A 600V T/D Class CC | 10 |
| 81087 | 30A 600V T/D Class CC | 10 |

HCTR Time Delay - Class CC

UL Fuses: Current Limiting

| MARS NO. | DESCRIPTION | MARS PACK |
|----------|-----------------------------------|-----------|
| 81194 | .25A UL CLASS CC Time Delay 600V | 10 |
| 81195 | .3A UL CLASS CC Time Delay 600V | 10 |
| 81197 | 2A UL CLASS CC Time Delay 600V | 10 |
| 81199 | 3.2A UL CLASS CC Time Delay 600V | 10 |
| 81601 | 4A UL CLASS CC Time Delay 600V | 10 |
| 81602 | 5A UL CLASS CC Time Delay 600V | 10 |
| 81603 | 6A UL CLASS CC Time Delay 600V | 10 |
| 81226 | 6.25A UL CLASS CC Time Delay 600V | 10 |
| 81604 | 8A UL CLASS CC Time Delay 600V | 10 |
| 81605 | 9A UL CLASS CC Time Delay 600V | 10 |
| 81196 | 10A UL CLASS CC Time Delay 600V | 10 |
| 81227 | 15A UL CLASS CC Time Delay 600V | 10 |
| 81198 | 20A UL CLASS CC Time Delay 600V | 10 |
| 81600 | 30A UL CLASS CC Time Delay 600V | 10 |

HCLR Fast Acting - Class CC

UL Fuses: Current Limiting

| MARS NO. | DESCRIPTION | MARS PACK |
|----------|--------------------------------|-----------|
| 81189 | 1A UL CLASS CC Fast Act 600V | 10 |
| 81977 | 2A UL CLASS CC Fast Act 600V | 10 |
| 81966 | 3A UL CLASS CC Fast Act 600V | 10 |
| 81191 | 3.5A UL CLASS CC Fast Act 600V | 10 |
| 81967 | 4A UL CLASS CC Fast Act 600V | 10 |
| 81192 | 5A UL CLASS CC Fast Act 600V | 10 |
| 81193 | 6A UL CLASS CC Fast Act 600V | 10 |
| 81971 | 10A UL CLASS CC Fast Act 600V | 10 |
| 81976 | 12A UL CLASS CC Fast Act 600V | 10 |
| 81968 | 15A UL CLASS CC Fast Act 600V | 10 |
| 81981 | 20A UL CLASS CC Fast Act 600V | 10 |
| 81190 | 25A UL CLASS CC Fast Act 600V | 10 |

MCL Midget Fuses, Fast-Acting

UL Fuses: General Purpose (13/32" x 1 1/2")

| MARS NO. | DESCRIPTION | MARS PACK |
|----------|--------------------------------------|-----------|
| 81907 | .5A UL MCL Fast Act Midget Fus 600V | 10 |
| 81909 | 1A UL MCL Fast Act Midget Fus 600V | 10 |
| 81910 | 1.5A UL MCL Fast Act Midget Fus 600V | 10 |
| 81911 | 2A UL MCL Fast Act Midget Fus 600V | 10 |
| 81916 | 3A UL MCL Fast Act Midget Fus 600V | 10 |
| 81628 | 3.5A UL MCL Fast Act Midget Fus 600V | 10 |
| 81912 | 4A UL MCL Fast Act Midget Fus 600V | 10 |
| 81913 | 5A UL MCL Fast Act Midget Fus 600V | 10 |
| 81914 | 6A UL MCL Fast Act Midget Fus 600V | 10 |
| 81918 | 7A UL MCL Fast Act Midget Fus 600V | 10 |
| 81915 | 8A UL MCL Fast Act Midget Fus 600V | 10 |
| 81917 | 10A UL MCL Fast Act Midget Fus 600V | 10 |
| 81919 | 15A UL MCL Fast Act Midget Fus 600V | 10 |
| 81920 | 20A UL MCL Fast Act Midget Fus 600V | 10 |
| 81627 | 25A UL MCL Fast Act Midget Fus 600V | 10 |
| 81922 | 30A UL MCL Fast Act Midget Fus 600V | 10 |





T Edison Base Plug Fuses - Dual Element, Time Delay

UL Fuses: General Purpose

| MARS NO. | DESCRIPTION | MARS PACK |
|----------|--|-----------|
| 81334 | 1 1/4AT PLG Fuse Dual Element TD 125V | 4 |
| 81337 | 2AT PLG Fuse Dual Element TD 125V | 4 |
| 81344 | 2 1/2AT PLG Fuse Dual Element TD 125V | 4 |
| 81338 | 3 2/10AT PLG Fuse Dual Element TD 125V | 4 |
| 81339 | 4AT PLG Fuse Dual Element TD 125V | 4 |
| 81340 | 5AT PLG Fuse Dual Element TD 125V | 4 |
| 81341 | 6 1/4AT PLG Fuse Dual Element TD 125V | 4 |
| 81342 | 8AT PLG Fuse Dual Element TD 125V | 4 |
| 81343 | 10AT PLG Fuse Dual Element TD 125V | 4 |
| 81660 | 15AT PLG Fuse Dual Element TD 125V | 4 |
| 81661 | 20AT PLG Fuse Dual Element TD 125V | 4 |
| 81662 | 30AT PLG Fuse Dual Element TD 125V | 4 |

TL Edison Base Plug Fuses - Time Delay

UL Fuses: General Purpose

| MARS NO. | DESCRIPTION | MARS PACK |
|----------|----------------------------------|-----------|
| 81346 | 15A Time Dly Base Plg FS TL 125V | 4 |
| 81347 | 20A Time Dly Base Plg FS TL 125V | 4 |
| 81348 | 25A Time Dly Base Plg FS TL 125V | 4 |
| 81349 | 30A Time Dly Base Plg FS TL 125V | 4 |

TC and P Edison Base Plug Fuses - Dual Element, Time Delay

UL Fuses: General Purpose

| MARS NO. | DESCRIPTION | MARS PACK |
|----------|--------------------------------------|-----------|
| 81350 | 15A Dual Element TimeDly TYP TC 125V | 4 |
| 81370 | 15A Dual Element TimeDly TYP TC 125V | 4 |
| 81351 | 20A Dual Element TimeDly TYP TC 125V | 4 |
| 81352 | 25A Dual Element TimeDly TYP TC 125V | 4 |
| 81353 | 30A Dual Element TimeDly TYP TC 125V | 4 |

GDA Fast Acting Ceramic Tube Small Dimension (Electronic) Fuses

5 x 20mm — IEC Standards High-Breaking Capacity Fuses UL Fuses: General Purpose

| MARS NO. | DESCRIPTION | MARS PACK |
|----------|---------------------------------------|-----------|
| 81168 | 630mA Fast Acting High Break GDA 250V | 4 |

GDB Fast Acting Glass Tube Small Dimension (Electronic) Fuses

5 x 20mm — IEC Standards Low Breaking Capacity Fuses UL Fuses: General Purpose

| MARS NO. | DESCRIPTION | MARS PACK |
|----------|--------------------------------------|-----------|
| 81171 | 630mA Fast Acting Low Break GDB 250V | 5 |
| 81169 | 3.15A Fast Acting Low Break GDB 250V | 5 |
| 81170 | 4A Fast Acting Low Break GDB 250V | 5 |



81334



81346



81350



81168



81171

Edison Fuses

MARS SERIES **810**



SERVICE & INSTALLATION

KON/KOS Fast Acting - Class H & K5

“One Time” UL Fuses: General Purpose

| MARS NO. | DESCRIPTION | MARS PACK |
|----------|-----------------------------------|-----------|
| 81624 | 1A UL CLASS K5 Fast Act KON 250V | 10 |
| 81210 | 10A UL CLASS K5 Fast Act KON 250V | 10 |
| 81212 | 15A UL CLASS K5 Fast Act KON 250V | 10 |
| 81213 | 20A UL CLASS K5 Fast Act KON 250V | 10 |
| 81214 | 25A UL CLASS K5 Fast Act KON 250V | 10 |
| 81215 | 30A UL CLASS K5 Fast Act KON 250V | 10 |
| 81216 | 35A UL CLASS K5 Fast Act KON 250V | 10 |
| 81217 | 40A UL CLASS K5 Fast Act KON 250V | 10 |
| 81218 | 45A UL CLASS K5 Fast Act KON 250V | 10 |
| 81219 | 50A UL CLASS K5 Fast Act KON 250V | 10 |
| 81220 | 60A UL CLASS K5 Fast Act KON 250V | 10 |
| 81221 | 70A UL CLASS H Fast Act KON 250V | 5 |
| 81625 | 80A UL CLASS H Fast Act KON 250V | 5 |
| 81224 | 100A UL CLASS H Fast Act KON 250V | 5 |
| 81626 | 5A UL CLASS H Fast Act KOS 600V | 10 |
| 81249 | 10A UL CLASS H Fast Act KOS 600V | 10 |
| 81251 | 15A UL CLASS K5 Fast Act KOS 600V | 10 |
| 81252 | 20A UL CLASS K5 Fast Act KOS 600V | 10 |
| 81253 | 25A UL CLASS K5 Fast Act KOS 600V | 10 |
| 81254 | 30A UL CLASS K5 Fast Act KOS 600V | 10 |
| 81255 | 35A UL CLASS K5 Fast Act KOS 600V | 10 |
| 81256 | 40A UL CLASS K5 Fast Act KOS 600V | 10 |
| 81259 | 60A UL CLASS K5 Fast Act KOS 600V | 10 |
| 81264 | 100A UL CLASS H Fast Act KOS 600V | 5 |

S Rejection Base Plug Fuses - Dual Element, Time Delay

UL Fuses: General Purpose

| MARS NO. | DESCRIPTION | MARS PACK |
|----------|---|-----------|
| 81307 | 1-1/4AS Reject Base Dual Element TD 125V | 4 |
| 81308 | 1-6/10AS Reject Base Dual Element TD 125V | 4 |
| 81311 | 2AS Reject Base Dual Element TD 125V | 4 |
| 81313 | 2-1/2AS Reject Base Dual Element TD 125V | 4 |
| 81315 | 3AS Reject Base Dual Element TD 125V | 4 |
| 81316 | 3-2/10AS Reject Base Dual Element TD 125V | 4 |
| 81318 | 4AS Reject Base Dual Element TD 125V | 4 |
| 81320 | 5AS Reject Base Dual Element TD 125V | 4 |
| 81323 | 6-1/4AS Reject Base Dual Element TD 125V | 4 |
| 81325 | 8AS Reject Base Dual Element TD 125V | 4 |
| 81326 | 9AS Reject Base Dual Element TD 125V | 4 |
| 81327 | 10AS Reject Base Dual Element TD 125V | 4 |
| 81328 | 12AS Reject Base Dual Element TD 125V | 4 |
| 81658 | 15AS Reject Base Dual Element TD 125V | 4 |

SL Rejection Base Plug Fuses - Time Delay

UL Fuses: General Purpose

| MARS NO. | DESCRIPTION | MARS PACK |
|----------|----------------------------------|-----------|
| 81330 | 15A Time Dly Base Plg FS SL 125V | 4 |
| 81331 | 20A Time Dly Base Plg FS SL 125V | 4 |
| 81332 | 25A Time Dly Base Plg FS SL 125V | 4 |
| 81333 | 30A Time Dly Base Plg FS SL 125V | 4 |

SA Rejection Base Fuse Adapter

UL Fuses: General Purpose

| MARS NO. | DESCRIPTION | MARS PACK |
|----------|------------------------------------|-----------|
| 81375 | 2-1/2ASA Reject Base Fuse Adapter | 4 |
| 81376 | 3-2/10ASA Reject Base Fuse Adapter | 4 |
| 81379 | 6-1/4ASA Reject Base Fuse Adapter | 4 |
| 81382 | 15ASA Reject Base Fuse Adapter | 4 |
| 81383 | 20ASA Reject Base Fuse Adapter | 4 |
| 81384 | 30ASA Reject Base Fuse Adapter | 4 |





ABC Small Dimension (Electronic) Fuses

1/4" x 1 1/4" Fast-Acting Fuses UL Fuses:
General Purpose

| MARS NO. | DESCRIPTION | MARS PACK |
|----------|-------------------------------|-----------|
| 81402 | 1.5A ABC Sm Dim Fast Act 250V | 5 |
| 81403 | 1/2A ABC Sm Dim Fast Act 250V | 5 |
| 81404 | 1A ABC Sm Dim Fast Act 250V | 5 |
| 81405 | 2A ABC Sm Dim Fast Act 250V | 5 |
| 81406 | 2.5A ABC Sm Dim Fast Act 250V | 5 |
| 81407 | 3A ABC Sm Dim Fast Act 250V | 5 |
| 81408 | 4A ABC Sm Dim Fast Act 250V | 5 |
| 81409 | 5A ABC Sm Dim Fast Act 250V | 5 |
| 81410 | 6A ABC Sm Dim Fast Act 250V | 5 |
| 81411 | 7A ABC Sm Dim Fast Act 250V | 5 |
| 81412 | 8A ABC Sm Dim Fast Act 250V | 5 |
| 81413 | 10A ABC Sm Dim Fast Act 250V | 5 |
| 81414 | 12A ABC Sm Dim Fast Act 250V | 5 |
| 81415 | 15A ABC Sm Dim Fast Act 250V | 5 |
| 81416 | 20A ABC Sm Dim Fast Act 250V | 5 |
| 81417 | 25A ABC Sm Dim Fast Act 125V | 5 |
| 81418 | 30A ABC Sm Dim Fast Act 125V | 5 |

AGC Small Dimension (Electronic) Fuses

1/4" x 1 1/4" Fast-Acting Fuses UL Fuses:
General Purpose

| MARS NO. | DESCRIPTION | MARS PACK |
|----------|---------------------------------------|-----------|
| 81070 | 1/16AAGC Sm Dim Glass Fast Act 250V | 5 |
| 81448 | 1/10AAGC Sm Dim Glass Fast Act 250V | 5 |
| 81450 | 1/4AAGC Sm Dim Glass Fast Act 250V | 5 |
| 81453 | 1/2AAGC Sm Dim Glass Fast Act 250V | 5 |
| 81470 | 2/10AAGC Sm Dim Glass Fast Act 250V | 5 |
| 81451 | 3/10AAGC Sm Dim Glass Fast Act 250V | 5 |
| 81455 | 3/4AAGC Sm Dim Glass Fast Act 250V | 5 |
| 81456 | 1AAGC Sm Dim Glass Fast Act 250V | 5 |
| 81457 | 1-1/4AAGC Sm Dim Glass Fast Act 250V | 5 |
| 81458 | 1-1/2AAGC Sm Dim Glass Fast Act 250V | 5 |
| 81460 | 2AAGC Sm Dim Glass Fast Act 250V | 5 |
| 81461 | 2-1/2AAGC Sm Dim Glass Fast Act 250V | 5 |
| 81462 | 3AAGC Sm Dim Glass Fast Act 250V | 5 |
| 81459 | 3-2/10AAGC Sm Dim Glass Fast Act 250V | 5 |
| 81071 | 3.5AAGC Sm Dim Glass Fast Act 250V | 5 |
| 81463 | 4AAGC Sm Dim Glass Fast Act 250V | 5 |
| 81464 | 5AAGC Sm Dim Glass Fast Act 250V | 5 |
| 81465 | 6AAGC Sm Dim Glass Fast Act 250V | 5 |
| 81072 | 7AAGC Sm Dim Glass Fast Act 250V | 5 |
| 81466 | 7-1/2AAGC Sm Dim Glass Fast Act 250V | 5 |
| 81467 | 8AAGC Sm Dim Glass Fast Act 250V | 5 |
| 81468 | 10AAGC Sm Dim Glass Fast Act 250V | 5 |
| 81474 | 12AAGC Sm Dim Glass Fast Act 250V | 5 |
| 81469 | 15AAGC Sm Dim Glass Fast Act 32V | 5 |
| 81471 | 20AAGC Sm Dim Glass Fast Act 32V | 5 |
| 81472 | 25AAGC Sm Dim Glass Fast Act 32V | 5 |
| 81473 | 30AAGC Sm Dim Glass Fast Act 32V | 5 |

AGX Small Dimension (Electronic) Fuses

1/4" x 1" Fast-Acting Fuses UL Fuses:
General Purpose

| MARS NO. | DESCRIPTION | MARS PACK |
|----------|-------------------------------------|-----------|
| 81484 | 1/2AAGX Sm Dim Glass Fast Act 250V | 5 |
| 81878 | 4/10AAGX Sm Dim Glass Fast Act 250V | 5 |
| 81486 | 1AAGX Sm Dim Glass Fast Act 250V | 5 |
| 81488 | 2AAGX Sm Dim Glass Fast Act 250V | 5 |
| 81877 | 3AAGX Sm Dim Glass Fast Act 250V | 5 |
| 81491 | 5AAGX Sm Dim Glass Fast Act 250V | 5 |



Edison Fuses

MARS SERIES **810**



SERVICE & INSTALLATION

GDC Time Delay Glass Tube Small Dimension (Electronics) Fuses

5 x 20mm — IEC Standards Low Breaking Capacity Fuses UL Fuses: General Purpose

| MARS NO. | DESCRIPTION | MARS PACK |
|----------|-------------------------------------|-----------|
| 81172 | 2A Time Delay Low Break GDC 250V | 5 |
| 81173 | 3.15A Time Delay Low Break GDC 250V | 5 |
| 81174 | 5A Time Delay Low Break GDC 250V | 5 |
| 81175 | FUSE Glass 6.3a 250V | 5 |

GMA Fast Acting, Glass Fuses, Small Dimension (Electronic) Fuses

5 x 20mm — N. American Standards, Fast Acting UL Fuses: General Purpose

| MARS NO. | DESCRIPTION | MARS PACK |
|----------|--|-----------|
| 81879 | .5A GMA Glass tube Fast Act fus 250V | 5 |
| 81181 | 1A GMA Glass tube Fast Act fus 250V | 5 |
| 81179 | 1.25A GMA Glass tube Fast Act fus 250V | 5 |
| 81881 | 2A GMA Glass tube Fast Act fus 250V | 5 |
| 81182 | 3.15A GMA Glass tube Fast Act fus 125V | 5 |
| 81183 | 3A GMA Glass tube Fast Act fus 250V | 5 |
| 81184 | 4A GMA Glass tube Fast Act fus 125V | 5 |
| 81185 | 5A GMA Glass tube Fast Act fus 125V | 5 |
| 81882 | 10A GMA Glass tube Fast Act fus 125V | 5 |

GLR Fast Acting Non Rejecting

Florescent Light

| MARS NO. | DESCRIPTION | MARS PACK |
|----------|----------------------------------|-----------|
| 81886 | 1-1/2A Fast Act Non Reject 300V | 5 |
| 81887 | 1-6/10A Fast Act Non Reject 300V | 5 |
| 81176 | 1A Fast Act Non Reject 300V | 5 |
| 81177 | 3A Fast Act Non Reject 300V | 5 |
| 81178 | 5A Fast Act Non Reject 300V | 5 |
| 81891 | 10A Fast Act Non Reject 300V | 5 |
| 81890 | 15A Fast Act Non Reject 300V | 5 |

GLQ Fast Acting Size Rejecting

Florescent Light

| MARS NO. | DESCRIPTION | MARS PACK |
|----------|----------------------------------|-----------|
| 81980 | 3A GLQ Fast Act Size Reject 300V | 5 |

GMQ Time Delay Fuses, Size Rejecting

Florescent Light

| MARS NO. | DESCRIPTION | MARS PACK |
|----------|---------------------------------------|-----------|
| 81188 | 8/10A GLQ Time Dly Size Reject 300V | 5 |
| 81186 | 3A GLQ Time Dly Size Reject 300V | 5 |
| 81880 | 3-2/10A GLQ Time Dly Size Reject 300V | 5 |
| 81884 | 4A GLQ Time Dly Size Reject 300V | 5 |
| 81187 | 5A GLQ Time Dly Size Reject 300V | 5 |

GMF Time delay, Non Rejecting

Florescent Light

| MARS NO. | DESCRIPTION | MARS PACK |
|----------|------------------------------------|-----------|
| 81888 | 3-2/10A Time Delay Non Reject 300V | 5 |

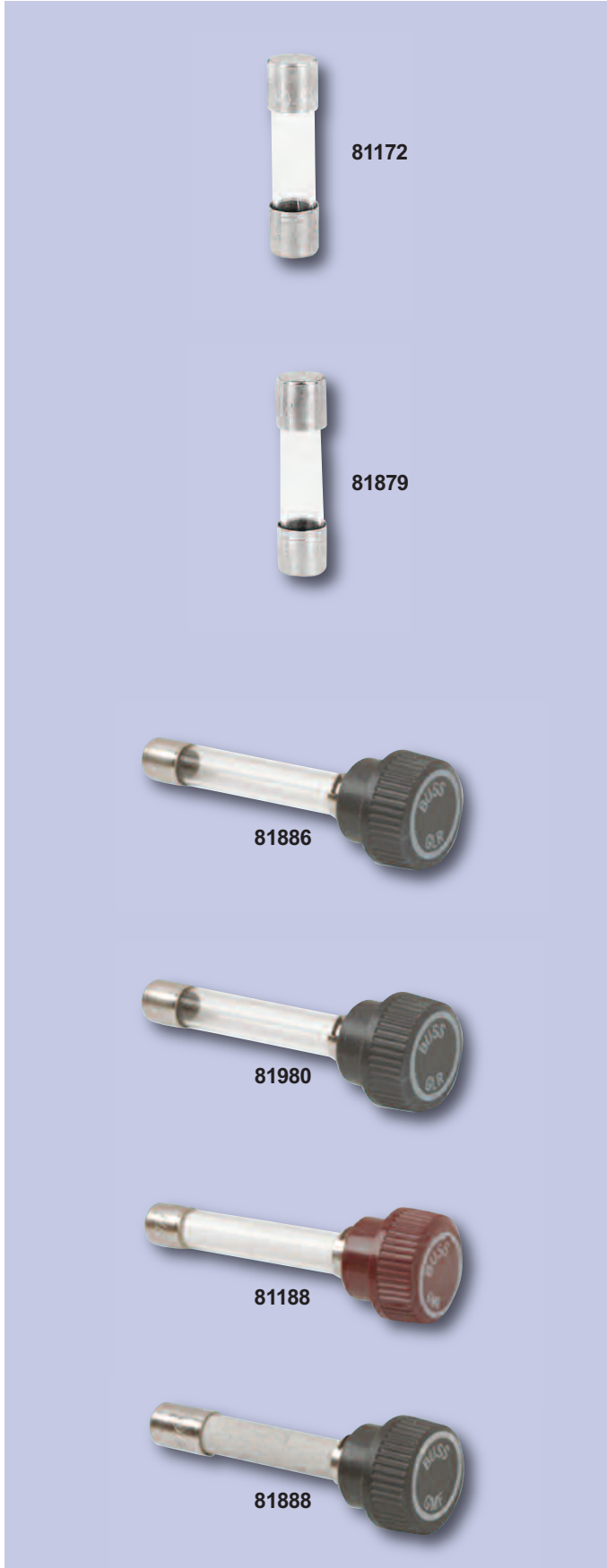



MDA Small Dimension (Electronic) Ceramic Fuses, 1/4" x 1-1/4"

Time-Delay UL Fuses: General Purpose

| MARS NO. | DESCRIPTION | MARS PACK |
|----------|--------------------------------|-----------|
| 81439 | 1A Ceramic Fuse Time Dly 250V | 10 |
| 81629 | 2A Ceramic Fuse Time Dly 250V | 10 |
| 81630 | 4A Ceramic Fuse Time Dly 250V | 10 |
| 81442 | 5A Ceramic Fuse Time Dly 250V | 5 |
| 81445 | 15A Ceramic Fuse Time Dly 250V | 5 |
| 81444 | 20A Ceramic Fuse Time Dly 250V | 5 |

MDL Small Dimension (Electronic) Fuses

1/4" x 1-1/4" Time-Delay Fuses UL Fuses:
General Purpose

| MARS NO. | DESCRIPTION | MARS PACK |
|----------|---------------------------------|-----------|
| 81631 | 1/2A Glass Fuse Time Dly 250V | 5 |
| 81635 | 3/10A Glass Fuse Time Dly 250V | 5 |
| 81502 | 1A Glass Fuse Time Dly 250V | 10 |
| 81505 | 1-1/2A Glass Fuse Time Dly 250V | 10 |
| 81507 | 2A Glass Fuse Time Dly 250V | 10 |
| 81508 | 2-1/2A Glass Fuse Time Dly 250V | 10 |
| 81510 | 3A Glass Fuse Time Dly 250V | 10 |
| 81512 | 4A Glass Fuse Time Dly 250V | 5 |
| 81513 | 5A Glass Fuse Time Dly 250V | 5 |
| 81514 | 7A Glass Fuse Time Dly 250V | 5 |
| 81517 | 8A Glass Fuse Time Dly 250V | 5 |
| 81518 | 10A Glass Fuse Time Dly 250V | 5 |
| 81519 | 15A Glass Fuse Time Dly 250V | 5 |
| 81633 | 20A Glass Fuse Time Dly 250V | 5 |
| 81643 | 30A Glass Fuse Time Dly 250V | 5 |

ATM Automotive Blade Type Fuse - Fast Acting UL Fuses

General Purpose Zinc ATM Fuses are Silver Plated

| MARS NO. | DESCRIPTION | MARS PACK |
|----------|-------------------------------------|-----------|
| 81354 | 10A ATM Auto BLADE-TYPE, Red 32V DC | 1 |

ATC Automotive Blade Type Fuse - Fast Acting UL Fuses

General Purpose Plastic Housing with Zinc
Fuse Element

| MARS NO. | DESCRIPTION | MARS PACK |
|----------|---------------------------------------|-----------|
| 81073 | 1AATC Auto BLADE-TYPE, Black 32V DC | 5 |
| 81074 | 2AATC Auto BLADE-TYPE, Gray 32V DC | 5 |
| 81230 | 3AATC Auto BLADE-TYPE, Violet 32V DC | 5 |
| 81232 | 4AATC Auto BLADE-TYPE, Pink 32V DC | 5 |
| 81231 | 5AATC Auto BLADE-TYPE, Tan 32V DC | 5 |
| 81233 | 7.5AATC Auto BLADE-TYPE, Brown 32V DC | 5 |
| 81234 | 10AATC Auto BLADE-TYPE, Red 32V DC | 5 |
| 81235 | 15AATC Auto BLADE-TYPE, Blue 32V DC | 5 |
| 81236 | 20AATC Auto BLADE-TYPE, Yellow 32V DC | 5 |
| 81237 | 25AATC Auto BLADE-TYPE, Clear 32V DC | 5 |
| 81238 | 30AATC Auto BLADE-TYPE, Green 32V DC | 5 |



81439



81631

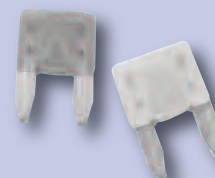

81354



81073

Edison Fuse Blocks

MARS SERIES **810**



SERVICE & INSTALLATION

2 Pole, Supplementary Fuse Block, Type M 600V

| MARS NO. | DESCRIPTION | MARS PACK |
|----------|--|-----------|
| 81062 | 30A 2P Buss Fuseblk Scrw QC, BM6032SQBS | 8 |
| 81066 | 30A 2P Buss Fseblk Prss Plt QC, BM6032PQ | 10 |

3 Pole, Supplementary Fuse Block, Type M 600V

| MARS NO. | DESCRIPTION | MARS PACK |
|----------|--|-----------|
| 81063 | 30A 3P BUSS FUSEBLK SCRW QC, BM6033SQ | 6 |
| 81067 | 30A 3P BUSS FSEBLK PRSS PLT QC, BM6033PQ | 10 |

Power Distribution & Terminal Blocks

| MARS NO. | DESCRIPTION | MARS PACK |
|----------|---|-----------|
| 81090 | 1 Pole 600V Power Terminal Block, 16220-1 | 48 |
| 81091 | 2 Pole 600V Power Terminal Block, 16220-2 | 24 |
| 81092 | 3 Pole 600V Power Terminal Block, 16220-3 | 24 |

BG and G Series Fuse Blocks - G Series Fuses (SEC)

| MARS NO. | DESCRIPTION | MARS PACK |
|----------|---|-----------|
| 81075 | 15A 3P 600V Screw w/QC, Class G, BG3013SQ | 1 |
| 81167 | 30A 3P 480V Box Lug w/Clip G30060-3CR | 1 |
| 81166 | 60A 3P 600V Box Lug w/clip, G30060-3C | 1 |

Fuse Pullers

| MARS NO. | DESCRIPTION | MARS PACK |
|----------|---|-----------|
| 81165 | Class T Fuses, 0 – 60A, 300/600V for dia 13/32" to 13/16" | 1 |
| 81098 | 0 – 60A, 250V 0 – 30A, 600V, for dia 13/32" to 13/16" | 1 |
| 81099 | 70 – 200A, 250V 35 – 200A, 600V, for dia 1" to 1 3/4" | 1 |

Panel-Mount and In-Line Fuse Holders Standard Fuse Holders With Screw

Type Knob: For use with 13/32" x 1 5/16" to 1 1/2" fuses

| MARS NO. | DESCRIPTION | MARS PACK |
|----------|--|-----------|
| 81987 | HPF-EE, 15A 480V (Sec) 0-15, 13/32" X 1 3/8" Fuses | 10 |
| 81989 | HPF-C Buss Fuseholder | 10 |

Standard Fuseholders

For use with 1/4" x 1-1/4" fuses (Edison type ABC, AGC, MDL, MDA etc.)

| MARS NO. | DESCRIPTION | MARS PACK |
|----------|--|-----------|
| 81991 | HKP-HH, 15A 250V with 1/4" QC Terminal | 10 |





1 Pole, Class H/K5 Fuse Block, 250V

For Use With KON, ERN, PONC, and CDNC Fuses

| MARS NO. | DESCRIPTION | MARS PACK |
|----------|---|-----------|
| 81011 | 1/10 - 30 Amps, Box Lug W/Clip and Reinforced Spring, H25030-1CR-BN | 1 |
| 81012 | 1/10 - 30 Amps, Screw W/Clip and Reinforced Spring, H25030-1Sr-Bn | 1 |
| 81116 | 31 - 60 Amps, Box Lug W/Clip and Reinforced Spring H25060-1CR-BN | 1 |

2 Pole, Class H/K5 Fuse Block, 250V

For Use With KON, ERN, PONC, and CDNC Fuses

| MARS NO. | DESCRIPTION | MARS PACK |
|----------|---|-----------|
| 81117 | 1/10 - 30 Amps, Box Lug W/Clip and Reinforced Spring, H25030-2CR-BN | 1 |

3 Pole, Class H/K5 Fuse Block, 250V

For Use With KON, ERN, PONC, and CDNC Fuses

| MARS NO. | DESCRIPTION | MARS PACK |
|----------|--|-----------|
| 81018 | 1/10 - 30 Amps, Box Lug w/ Clip and Reinforced Spring, H25030-3CR-BN | 1 |

1 Pole, Class H/K5 Fuse Block, 600V

For Use With KOS, ERS, and CDSC Fuses

| MARS NO. | DESCRIPTION | MARS PACK |
|----------|--|-----------|
| 81031 | 1/10 - 30 Amps, Box lug w/ Clip and Reinforced Spring, H60030-1CR-BN | 1 |
| 81130 | 1/10 - 30 Amps, Screw, H60030-1S | 1 |

2 Pole, Class H/K5 Fuse Block, 600V

For Use With KOS, ERS, and CDSC Fuses

| MARS NO. | DESCRIPTION | MARS PACK |
|----------|----------------------------------|-----------|
| 81433 | 1/10 - 30 Amps, Screw, H60030-2S | 1 |

Type M Supplementary Fuseblocks

For use with any 13/32"x1 1/2" Fuses (Bussmann KTK, FNQ, FNM, BAF, BAN, and AGU) 1 Pole, Supplementary Fuse Block, Type M 600V

| MARS NO. | DESCRIPTION | MARS PACK |
|----------|--|-----------|
| 81061 | 30A 1P Buss Fuseblk Scrw QC, BM6031SQ | 10 |
| 81069 | 30A 1P Buss Fuseblock Bx Lug, BM6031B | 10 |
| 81065 | 30A 1P Buss Fseblk Prss Plt QC, BM6031PQ | 10 |

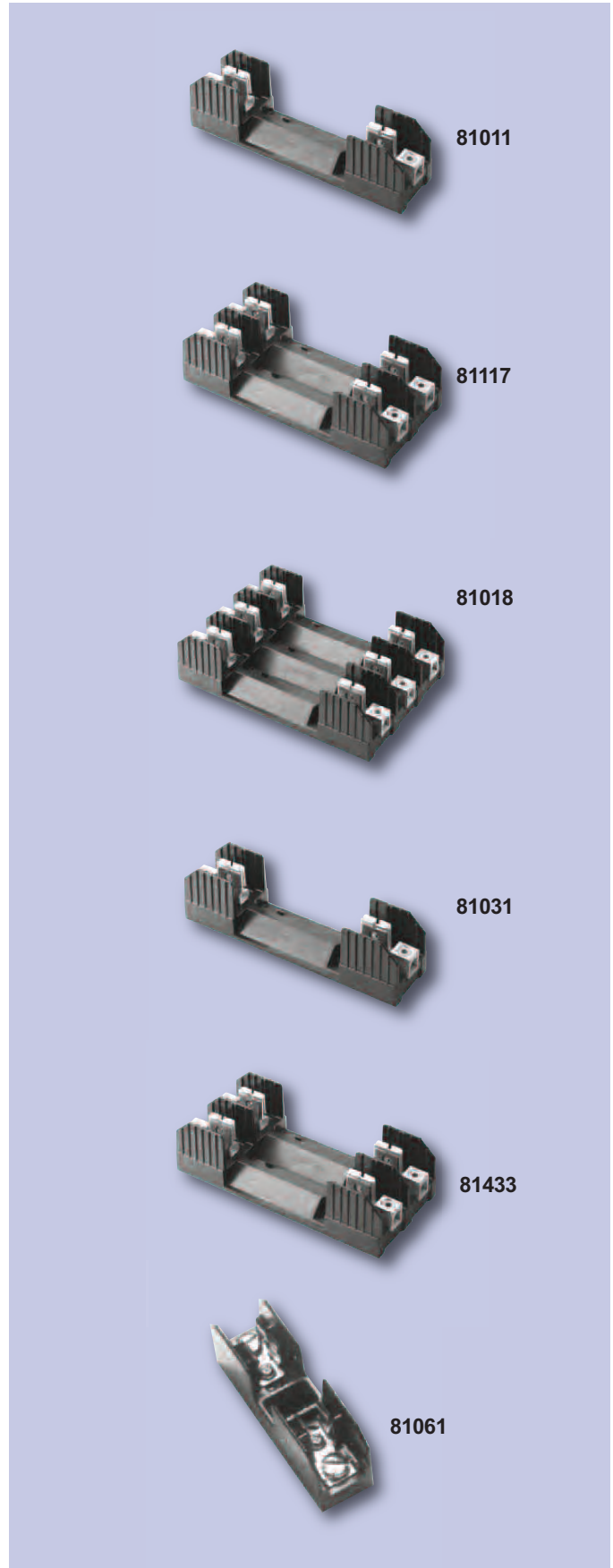

Edison Fuse Blocks

MARS SERIES **810**



SERVICE & INSTALLATION

Universal In-Line Fuseholder

For use with 1/4" x 7/8" to 1-1/4" fuses

| MARS NO. | DESCRIPTION | MARS PACK |
|----------|--|-----------|
| 81993 | HRK, 15A 32V 1/4" dia fuses of different lengths | 10 |

In-Line Fuseholders For 13/32" x 1-1/2" Fuses

MOL MEN, MEQ and MCL (1/10 -30A)

| MARS NO. | DESCRIPTION | MARS PACK |
|----------|------------------------------------|-----------|
| 81997 | HEB-AA 30A 1P 600V Buss Fuseholder | 10 |

Fuse Reducers for Class H & K

Dimension Fuses KON, ERN, PONC, CDNC KOS, ERS, CDSC

| MARS NO. | DESCRIPTION | MARS PACK |
|----------|------------------------------|-----------|
| 81975 | 250V, 30A, Buss Fuse Reducer | 1 |

HLQ Fuseholder Use with: GLQ and GMQ

| MARS NO. | DESCRIPTION | MARS PACK |
|----------|--------------------------------|-----------|
| 81607 | In-Line Fuse Holder HLQ-3 2/10 | 10 |
| 81606 | Fuse Holder 16-wire, 16A | 10 |

Class R Fuseblocks

(250V ECNR, LENRK, and NCLR & 600V ECSR, LESRK, and SCLR) Catalog Data Terminal Type (Suffix No.) Dimensions

| MARS NO. | DESCRIPTION | MARS PACK |
|----------|--|-----------|
| 81675 | 60A 2P Box Lug 250V Fuse Block R25060-2CR | 1 |
| 81655 | 30A 3P Box Lug 250V Fuse Block R25030-3CR | 1 |
| 81657 | 100A 3P Box Lug 600V Fuse Block R60100-3CR | 1 |
| 81676 | FUSE BLOCK 60-AMP, 250VAC | 1 |

Box Cover Units for Plug Fuses

Plug-Fuse Box Cover Units provide a simple inexpensive way to protect small motors with Edison dual-element type "T" or type "TL" plug fuses.

| MARS NO. | DESCRIPTION | MARS PACK |
|----------|---|-----------|
| 81793 | 2-1/4" Handy Single Fuse holder 125V 15A for Plg Fuse w/Rcptcl, Max Motor Size 1/2HP SRU | 1 |
| 81795* | 2-1/4" Handy Single Fuse holder 125V 15A for Plg Fuse w/Rcptcl, Control Switch, Max Motor Size 1/2HP SSU (Do not use on DC) | 1 |

*Switch turns power to fused load OFF or ON

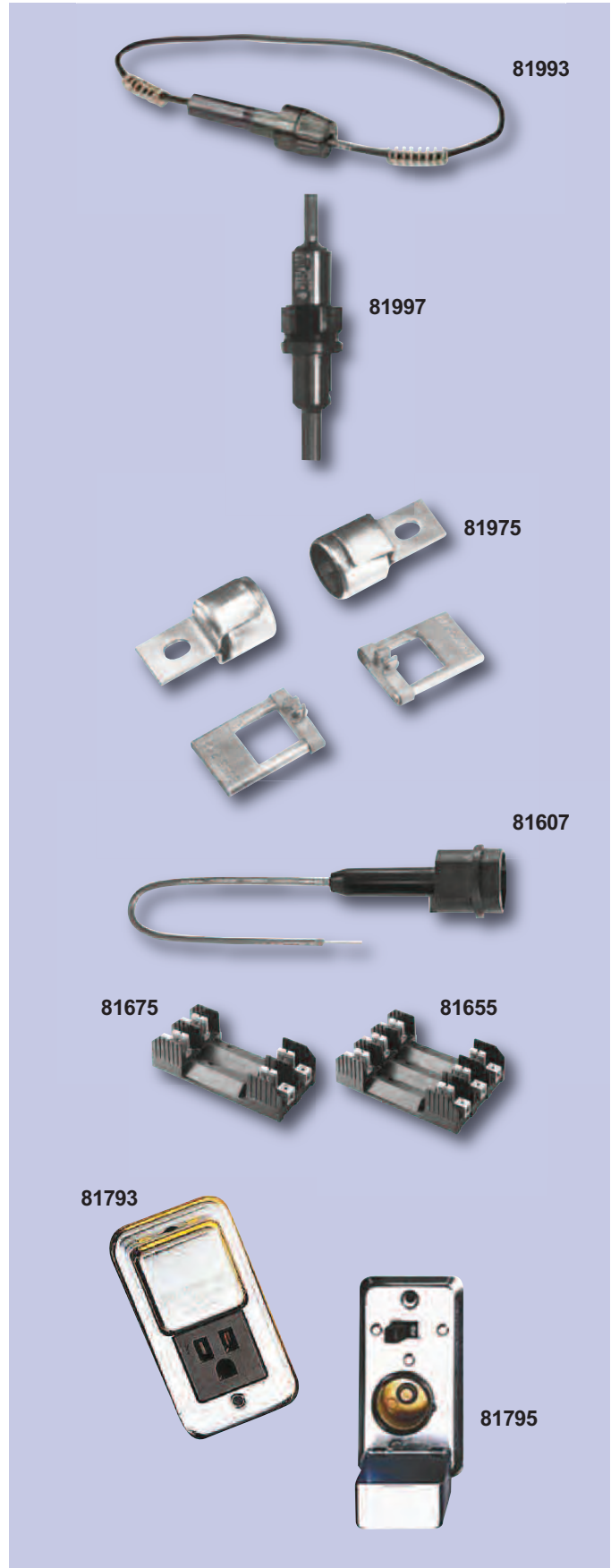

Fuses With A Resealable Plastic Pouch

| MARS NO. | DESCRIPTION | MARS PACK |
|----------|------------------------------------|-----------|
| 08569 | 3 Amp Standard Size Plastic, 25/pk | 1 |
| 08570 | 5 Amp Standard Size Plastic, 25/pk | 1 |
| 08571 | Assorted Fuses, 25/pk | 1 |

Fuses & Fuse Holders

Zebra Instruments offers a 4 pack Medium Duty (15A) standard size plastic fuses and fuse holder. This allows you to replace (or install) fuse protection for transformer outputs (and other devices) in HVAC systems .

| MARS NO. | DESCRIPTION | MARS PACK |
|----------|--|-----------|
| 08568 | 4 kits – Medium duty 15Amp Standard Size Plastic | 1 |



Wiring Devices

Toggle Switches With Ground

| MARS NO. | DESCRIPTION | MARS PACK | CASE QTY. |
|----------|--|-----------|-----------|
| 84712 | 15a -120V, 1P, silent, brown (bulk) | 10 | 100 |
| 84800 | 15a -120V, 1P, silent, ivory (bulk) | 10 | 100 |
| 84706 | 15a -120/277V, 1P, silent, ivory (bulk) | 10 | 100 |
| 84727 | 20a -120/277V, 1P, silent, brown (bulk) | 10 | 100 |
| 84707 | 20a -120/277V, 1P, silent, ivory (bulk) | 10 | 100 |
| 84708 | 15a -120/277V, 2P, silent, ivory (bulk) | 10 | 100 |
| 84709 | 20a -120/277V, 2P, silent, ivory (bulk) | 10 | 100 |
| 84799 | Combo switch/receptacle ivory (bulk) switch 15a-120/277V, 1P receptacle 15a-125V, 2P, 3W | 10 | 100 |
| 84732 | Tamper resistant smartlock pro combo switch/receptacle, ivory, 15a – 125V | 10 | 100 |

Toggle Switches Without Ground

| MARS NO. | DESCRIPTION | MARS PACK | CASE QTY. |
|----------|--|-----------|-----------|
| 84798 | 15a -120V, 1P, silent, ivory (bulk) | 10 | 100 |
| 84726 | 15a -120/277V, 1P, switch w/pilot light (card) | 1 | 100 |

Metal Bat Handle Switches - Screw Terminals 10a-250V, 15a-125V, 3/4 HP 120/240

| MARS NO. | DESCRIPTION | MARS PACK |
|----------|-------------|-----------|
| 84760 | SPST on off | 1 |

Straight Blade Receptacles With Ground

| MARS NO. | DESCRIPTION | MARS PACK | CASE QTY. |
|----------|--|-----------|-----------|
| 84721 | Single, ivory, 20a, 125V, 2P, 3W (bulk) | 10 | 100 |
| 84723 | Single, ivory, 20a, 250V, 2P, 3W (bulk) | 10 | 100 |
| 84746 | Single, brn, 20a, 250V, 2P, 3W (bulk) | 10 | 100 |
| 84715 | Duplex, ivory, 15a, 125V, 2P, 3W (bulk) | 10 | 100 |
| 84748 | Duplex, brn, 15a, 125V, 2P, 3W (bulk) | 10 | 100 |
| 84797 | Dup, ivory, EZ wire/screw, 15a, 125V, (bulk) | 10 | 100 |
| 84716 | Dup, ivory, 20a, 125V, 2P, 3W (bulk) | 10 | 100 |
| 84756 | Dup, brn, 20a, 125V, 2P, 3W (bulk) | 10 | 100 |

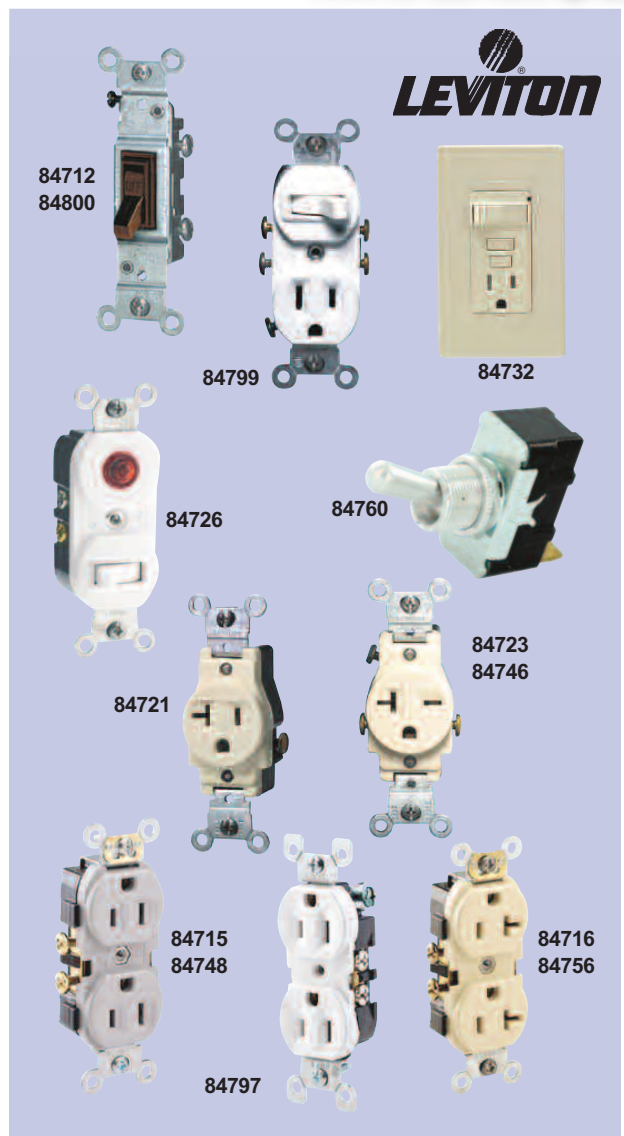

SERVICE & INSTALLATION

Wiring Devices

MARS SERIES **847**



Plugs, Connectors And Adapters

| MARS NO. | DESCRIPTION | MARS PACK | CASE QTY. |
|----------|---|-----------|-----------|
| 84770 | Grnd rubr hndl plug, 2P, 3W, 15a, 125V, black | 10 | 100 |
| 84772 | Armrd plug, 2P, 3W, 15a, 125V, | 10 | 100 |
| 84785 | Blk rubr rnd conn, 2P, 3W, 15a, 125V | 10 | 100 |
| 84773 | Blk armored conn, 2P, 3W, 15a, 125V | 10 | 100 |
| 84786 | Blk armrd conn, 2P, 3W, 15a, 125V (card) | 1 | 10 |

GFCI Duplex Receptacles

| MARS NO. | DESCRIPTION | MARS PACK | CASE QTY. |
|----------|--|-----------|-----------|
| 84767 | 15a, 125V, ivory, EZ wire & screw | 1 | 10 |
| 84768 | 15a, 125V, ivory, EZ wire & screw (card) | 1 | 10 |

Wall Plates - Plastic

| MARS NO. | DESCRIPTION | MARS PACK | CASE QTY. |
|----------|-------------------------|-----------|-----------|
| 84751 | Single toggle ivory | 25 | 250 |
| 84809 | Duplex receptacle ivory | 25 | 100 |

Pullchain Lampholders - White

| MARS NO. | DESCRIPTION | MARS PACK | CASE QTY. |
|----------|------------------------------------|-----------|-----------|
| 84719 | Porcelain lampholder w/ receptacle | 1 | 50 |

Box Cover Units - 125V - For T Plug Fuses

| MARS NO. | DESCRIPTION | MARS PACK |
|----------|--|-----------|
| 84793 | 2 1/4" handy box receptacle cover, CRU | 1 |
| 84795 | 2 1/4" handy box switch cover, CSU | 1 |
| 84794 | 4" square box switch cover, CSY | 1 |
| 84814 | 4" octagon box switch cover, CSX | 1 |

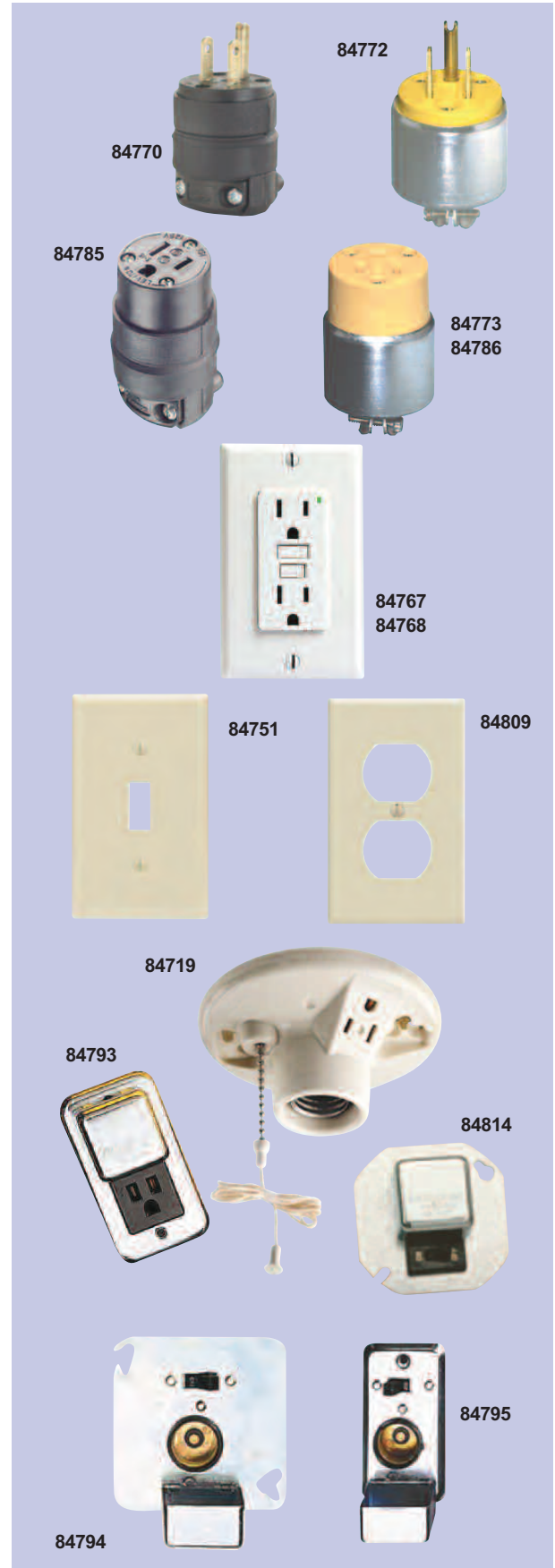

SERVICE & INSTALLATION



Wire Nut Connectors

MARS SERIES **259**

Ideal Wire Nut® Wire Connectors

IDEAL's Wire Nut® wire connectors are second to none and preferred by electricians industry wide. There are five color coded models covering every wiring combination. Some features include: positive grip design, flame retardant thermoplastic shell, longest fully seated square wire spring, threaded entry, deep skirt and wide throat entry. All Wire Nut® wire connectors are UL listed and CSA certified

Greenie® grounding connectors enjoy all the benefits of the other Wire Nut® connectors, but are designed for making ground connections with a built-in hole for copper ground hook. They have a live action, square wire spring for easy and strong connections with built-in contoured wings.

Twister® wire connectors have become widely accepted due to their unsurpassed features: ribbed cap, fluted surface, compact, swept wings, hexagonal shape, tough thermoplastic shell, live action square wire spring and deep threaded skirt entry. Nutmaster™ nutdrivers can be used to install Twister® wire connectors quickly and securely. Twister® wires are UL and CSA approved. Exceptional wire range capacity for their size, just two Twister® wire connectors handle all wire combinations. This means reduced inventories and lower costs!

Wing Nut® wire connectors were first introduced by IDEAL in 1958 and remain the most comfortable, easy to use connector on the market. The wings act as a built in wrench to provide extra leverage for secure connections...every time. Wing Nut® wire connectors handle a wide range of branch circuit and fixture wiring requirements. Just three color coded models handle UL listed wire combinations from (2) No. 18's to (1) No. 6 with (2) No. 8's, solid or stranded wire.

| MARS NO. | DESCRIPTION | BOX QTY. | MFG. NO | MARS PACK | CASE QTY. |
|----------|------------------------------|----------|---------|-----------|-----------|
| 25930 | Gray wire nut, 22-14 AWG | 100 | 30-071 | 1 | 10 |
| 25931 | Blue wire nut, 22-14 AWG | 100 | 30-072 | 1 | 10 |
| 25932 | Orange wire nut, 22-14 AWG | 100 | 30-073 | 1 | 10 |
| 25933 | Yellow wire nut, 18-10 AWG | 100 | 30-074 | 1 | 10 |
| 25934 | Red wire nut, 18-8 AWG | 100 | 30-076 | 1 | 10 |
| 25935 | Greenie conn., 14-10 AWG | 100 | 30-092 | 1 | 10 |
| 25936 | Tan twister conn., 22-10 AWG | 100 | 30-341 | 1 | 10 |
| 25976 | Tan twister conn., 22-10 AWG | 500 | 30-641 | 1 | 10 |
| 25937 | Gray twister conn., 16-8 AWG | 50 | 30-342 | 1 | 20 |
| 25938 | Yellow wing nut, 18-10 AWG | 100 | 30-451 | 1 | 10 |
| 25939 | Red wing nut, 18-10 AWG | 100 | 30-452 | 1 | 10 |
| 25979 | Red wing nut, bag, 18-10 AWG | 500 | 30-652 | 1 | 10 |
| 25940 | Blue wing nut, 14-6 AWG | 25 | 30-454 | 1 | 10 |



SERVICE & INSTALLATION

Wire Connectors

MARS SERIES **259 & 842**



MARS Wire Connectors

MARS wire connectors are available in five color coded models: gray, blue, orange, yellow and red. Some features include a positive grip design and flame retardant thermoplastic shell. The large throat provides easy wire entrance and the deep skirt prevents shorts and grounds.

| MARS NO. | DESCRIPTION | MARS PACK |
|----------|---------------------------------------|-----------|
| 25860 | Gray wire connector, 300V (25/bag) | 1 |
| 25880 | Gray wire connector, 300V (100/bag) | 1 |
| 25861 | Blue wire connector, 300V (25/bag) | 1 |
| 25881 | Blue wire connector, 300V (100/bag) | 1 |
| 25862 | Orange wire connector, 600V (25/bag) | 1 |
| 25882 | Orange wire connector, 600V (100/bag) | 1 |
| 25863 | Yellow wire connector, 600V (25/bag) | 1 |
| 25883 | Yellow wire connector, 600V (100/bag) | 1 |
| 25864 | Red wire connector, 600V (25/bag) | 1 |
| 25884 | Red wire connector, 600V (100/bag) | 1 |
| 25868 | Yellow wing connector, 600V (25/bag) | 1 |
| 25888 | Yellow wing connector, 600V (100/bag) | 1 |
| 25869 | Red wing connector, 600V (25/bag) | 1 |
| 25889 | Red wing connector, 600V (100/bag) | 1 |
| 25870 | Blue wing connector, 600V (10/bag) | 1 |
| 25800 | Blue wing connector, 600V (50/bag) | 1 |



25882



25878

MARS Wire Connectors - Jar

| MARS NO. | DESCRIPTION | MARS PACK |
|----------|--|-----------|
| 25875 | MARS Yellow Wire connectors, 600V, 100/Jar | 1 |
| 25876 | MARS Orange Wire connectors, 600V, 100/Jar | 1 |
| 25877 | MARS Red Wire connectors, 600V, 50/Jar | 1 |
| 25878 | MARS Winged Blue Wire connectors, 600V, 25/Jar | 1 |

Wiregard Color-Coded Screw-On Wire Connectors

MARS now offers Gardner Bender wire connectors. The industry's standard screw-on connector, with high quality, performance and durability.

- UL listed, CSA approved.
- Color-coded for easy size selection.
- Makes quick, secure connections for positive continuity. Tightens without ratcheting, removable for re-use. Fluted shell surface allows for easy finger-tight connections.
- Thermoplastic shell shields against environmental extremes. Flame retardant up to 221 degrees F.
- Superior flash-over protection. High-dielectric shell features deep skirt design to prevent exposure of bare wire.
- Versatile size selection covers building wire combinations from #22 to #10 AWG.
- Complies with Federal Specification W-5-610d.

| MARS NO. | MFG. NO. | MODEL/SIZE | COLOR | BOX QTY. | CASE QTY. |
|----------|----------|------------|--------|----------|-----------|
| 25950 | 10-001 | GB-1 | Gray | 100 Box | 10 |
| 25941 | 10-002 | GB-2 | Blue | 100 Box | 10 |
| 25942 | 10-003 | GB-3 | Orange | 100 Box | 10 |
| 25943 | 10-004 | GB-4 | Yellow | 100 Box | 10 |
| 25944 | 10-006 | GB-6 | Red | 100 Box | 10 |



25950



25941



25942



25943



25944

GB
Gardner Bender

Stranded Copper Building Wire, 19 Strands 10-14 Ga. THHN, 16-18 Ga. TFFN, 600V, 90°C

| MARS NO. | DESCRIPTION | | | MARS PACK |
|----------|-------------|--------|------------|-----------|
| 84289 | 16 gauge | red | 100' spool | 1 |
| 84292 | 16 gauge | black | 100' spool | 1 |
| 84295 | 16 gauge | white | 100' spool | 1 |
| 84301 | 16 gauge | blue | 100' spool | 1 |
| 84304 | 16 gauge | yellow | 100' spool | 1 |
| 84307 | 14 gauge | red | 100' spool | 1 |
| 84308 | 14 gauge | red | 500' spool | 1 |
| 84310 | 14 gauge | black | 100' spool | 1 |
| 84311 | 14 gauge | black | 500' spool | 1 |
| 84313 | 14 gauge | white | 100' spool | 1 |
| 84314 | 14 gauge | white | 500' spool | 1 |
| 84319 | 14 gauge | blue | 100' spool | 1 |

Solid Copper Building Wire, 10-14 Ga. THHN, 600V, 90°C

| MARS NO. | DESCRIPTION | | | MARS PACK |
|----------|-------------|-------|------------|-----------|
| 84361 | 14 gauge | black | 500' spool | 4 |
| 84362 | 14 gauge | white | 500' spool | 4 |
| 84363 | 14 gauge | green | 500' spool | 4 |

Stranded Copper Building Wire, 19 Strands 10-14 Ga. THHN, 16-18 Ga. TFFN, 600V, 90°C (cont.)

| MARS NO. | DESCRIPTION | | | MARS PACK |
|----------|-------------|-------|------------|-----------|
| 84322 | 12 gauge | red | 100' spool | 1 |
| 84325 | 12 gauge | black | 100' spool | 1 |
| 84328 | 12 gauge | white | 100' spool | 1 |
| 84337 | 10 gauge | red | 100' spool | 1 |
| 84340 | 10 gauge | black | 100' spool | 1 |
| 84341 | 10 gauge | black | 500' spool | 1 |
| 84343 | 10 gauge | white | 100' spool | 1 |
| 84344 | 10 gauge | white | 500' spool | 1 |
| 84346 | 10 gauge | green | 100' spool | 1 |
| 84349 | 10 gauge | blue | 100' spool | 1 |
| 84352 | 8 gauge | black | 500' spool | 1 |



SERVICE & INSTALLATION

Wire Products

MARS SERIES **842**



Non-Metallic Sheathed Cable - Romex Wire Cable Type NM-B 600V - 90°C

| MARS NO. | DESCRIPTION | MARS PACK |
|----------|---|-----------|
| 84251 | 6 AWG, 2 conductors w/ground 125' coil | 1 |
| 84253 | 8 AWG, 2 conductors w/ground 125' coil | 1 |
| 84255 | 10 AWG, 2 conductors w/ground, 250' Reel, boxed | 1 |
| 84257 | 12 AWG, 2 conductors w/ground, 250' Reel, boxed | 1 |
| 84259 | 14 AWG, 2 conductors w/ground, 250' Reel, boxed | 1 |

SJ Wire - 250 Foot Rolls

| MARS NO. | DESCRIPTION | MARS PACK |
|----------|-------------------|-----------|
| 84380 | 12/3 250 ft. roll | 1 |
| 84381 | 14/3 250 ft. roll | 1 |
| 84382 | 16/3 250 ft. roll | 1 |

Mini-Split Installation Wire

Corra/Clad MC Cable consists of UL listed THHN soft drawn annealed solid copper conductors, cabled with fillers and wrapped with an overall solid Flexi-Rib aluminum sheath. The continuous sheath provides watertight protection and it is covered with a PVC outer jacket for outdoor use or direct burial. Cost effective, easy to strip and install. Meets all national codes and is suitable for outdoor use, under concrete, underground, and through interior walls and ceilings.

Compact 600 and Shielded Low Voltage Cables offer additional options to provide power and control to mini-split installations. Compact 600 uses a TPE jacket and is flexible, easy to strip, and is burial rated.

EZ-In™ cable is an all-purpose cable that meets code for both interior and exterior use, increasing the speed of installation and making sure the job will pass inspection. EZ-In™ Mini-Split Cable can be installed without the use of conduit and may be installed indoors and outdoors in wet locations.

Corra/Clad MC Cable: 600V, UL, NEC 330 Direct Burial

| MARS NO. | DESCRIPTION | MARS PACK |
|----------|--------------------------------------|-----------|
| 84470 | 14/3 Solid THHN w/Ground – 50' Roll | 1 |
| 84471 | 14/3 Solid THHN w/Ground – 250' Reel | 1 |
| 84472 | Liquid-tight MC Cable Connector | 1 |

Compact 600 Cable: 600V, UL, UV Rated, Direct Burial

| MARS NO. | DESCRIPTION | MARS PACK |
|----------|---|-----------|
| 84473 | 14/4 Solid THHN Compact 600 – 50' Roll | 1 |
| 84474 | 14/4 Solid THHN Compact 600 – 250' Reel | 1 |
| 84479 | 14/4 Stranded THHN Compact 600V – 50' Roll | 1 |
| 84480 | 14/4 Stranded THHN Compact 600V – 250' Reel | 1 |
| 84475 | 14/7 Stranded THHN Compact 600 – 250' Reel | 1 |

Shielded Low Voltage Cable: 300V, NEC 725/800, ETL, CMR/CL3R

| MARS NO. | DESCRIPTION | MARS PACK |
|----------|--|-----------|
| 84484 | 16/2 Stranded Shielded – 250' Reel | 1 |
| 84476 | 18/2 Stranded BC Shielded – 50' Roll | 1 |
| 84478 | 18/4 Stranded BC Shielded – 50' Roll | 1 |
| 84482 | 18/2 OAS CMR/CL3R Gy – 500' Reel | 1 |
| 84483 | 18/4 OAS CMR/CL3R Gy – 500' Reel For LG Mini-Splits | 1 |

EZ-In™ Cable: 600V, UL, All Purpose, UV Rated, Direct Burial

| MARS NO. | DESCRIPTION | MARS PACK |
|----------|--------------------------------------|-----------|
| 84486 | 14/4 Stranded EZ-In, 600V, 50' Roll | 1 |
| 84487 | 14/4 Stranded EZ-In, 600V, 250' Reel | 1 |

84251



84380



84470

84471



84472



84473

84474



84475



84484



84476



84478



84486

84487





Thermostat Wire

MARS SERIES **842**

MARS 18 Gauge Thermostat Cable - UL Listed

Specifications: UL type CL2. UV rated. Temp rating -20° + 60°C. Meets UL subject 13 per article 725 of the 1990 National Electric Code (NEC) for power limited circuit cable. Soft drawn bare copper, semi-rigid pvc insulation and PVC overall jacket.

| MARS NO. | DESCRIPTION | LBS. MFT | MARS PACK |
|----------|--------------------------------------|----------|-----------|
| 84201 | 18 AWG, 2 conductors, 500 ft. spool | 15 | 4 |
| 84202 | 18 AWG, 3 conductors, 500 ft. spool | 21 | 4 |
| 84203 | 18 AWG, 4 conductors, 250 ft. spool | 27 | 4 |
| 84204 | 18 AWG, 5 conductors, 250 ft. spool | 34 | 4 |
| 84205 | 18 AWG, 6 conductors, 250 ft. spool | 40 | 4 |
| 84206 | 18 AWG, 7 conductors, 250 ft. spool | 45 | 4 |
| 84207 | 18 AWG, 8 conductors, 250 ft. spool | 51 | 4 |
| 84209 | 18 AWG, 10 conductors, 250 ft. spool | 63 | 4 |
| 84210 | 18 AWG, 12 conductors, 250 ft. spool | 74 | 4 |
| 84231 | 18 AWG, 2 conductors, 250 ft. spool | 15 | 4 |
| 84232 | 18 AWG, 3 conductors, 250 ft. spool | 21 | 4 |

MARS 20 Gauge Thermostat Cable - UL Listed

| MARS NO. | DESCRIPTION | LBS. MFT | MARS PACK |
|----------|-------------------------------------|----------|-----------|
| 84211 | 20 AWG, 2 conductors, 500 ft. spool | 11 | 4 |
| 84212 | 20 AWG, 3 conductors, 500 ft. spool | 15 | 4 |
| 84213 | 20 AWG, 4 conductors, 250 ft. spool | 20 | 4 |
| 84214 | 20 AWG, 5 conductors, 250 ft. spool | 24 | 4 |
| 84215 | 20 AWG, 6 conductors, 250 ft. spool | 27 | 4 |
| 84217 | 20 AWG, 8 conductors, 250 ft. spool | 35 | 4 |

Shielded Plenum T-Stat Wire - UL Listed - Type CL2P-Stranded

| MARS NO. | DESCRIPTION | LBS. MFT | MARS PACK |
|----------|------------------------------------|----------|-----------|
| 84461 | 18 AWG, 2 conductors, 500 ft spool | 4 | 4 |
| 84462 | 18 AWG, 3 conductors, 500 ft spool | 4 | 4 |
| 84466 | 18 AWG, 8 conductors, 500 ft spool | 4 | 4 |

84210



84211



SERVICE & INSTALLATION

Thermostat Wire

MARS SERIES **842**



18 Ga UL Thermostat Wire – Self Dispensing Coils

MARS thermostat wire is now available in self dispensing coil packs. These shrink wrapped coils are easier to use and more convenient to store than the traditional thermostat wire sold on spools/reels.

Features & benefits:

- Heavy duty shrink wrapped coils for durability
- No reels to bend, break, or rust
- Compact coils are easier to store – takes up less space
- Easier to handle
- Stacks better
- Easy and convenient to use

How to use:

- Simply punch hole in center of wrap.
(Do not remove wrap)
- Pull loose end of wire from center
(Wire will pull out easily)
- Snip off the required amount of wire
- Tuck loose end back into the coil for storage

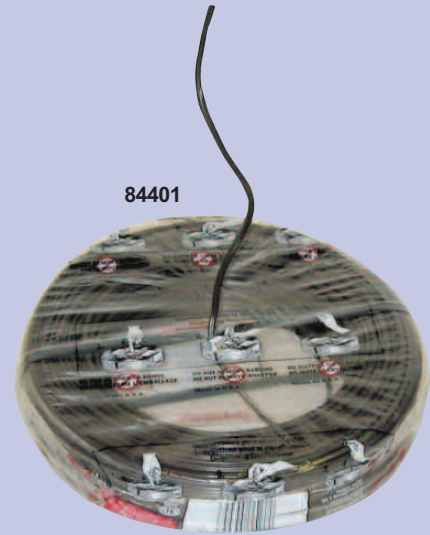

| MARS NO. | DESCRIPTION | MARS PACK |
|----------|--------------------|-----------|
| 84401 | 18/2 500 ft. Coils | 4 |
| 84402 | 18/3 500 ft. Coils | 4 |
| 84403 | 18/4 250 ft. Coils | 4 |
| 84404 | 18/5 250 ft. Coils | 4 |
| 84405 | 18/6 250 ft. Coils | 4 |
| 84406 | 18/7 250 ft. Coils | 4 |
| 84407 | 18/8 250 ft. Coils | 4 |

Plenum T-Stat Wire - Solid UL Listed

Temp rating (-20°C to 75°C) • UL type, CL2P

Thermoplastic jacket (2500 psi min)

Thermoplastic insulation (2000 psi min)

Can be used in overhead plenum area without conduit

84241



| MARS NO. | DESCRIPTION | MARS PACK |
|----------|-------------------------------------|-----------|
| 84241 | 18 AWG, 2 conductors, 500 ft. spool | 4 |
| 84242 | 18 AWG, 3 conductors, 500 ft. spool | 4 |
| 84243 | 18 AWG, 4 conductors, 250 ft. spool | 4 |
| 84244 | 18 AWG, 5 conductors, 250 ft. spool | 4 |
| 84245 | 18 AWG, 6 conductors, 250 ft. spool | 4 |
| 84246 | 18 AWG, 8 conductors, 250 ft. spool | 4 |

| MARS NO. | DESCRIPTION | MARS PACK |
|----------|-------------------------------------|-----------|
| 84441 | 18 AWG, 2 conductors, 500 ft. spool | 4 |
| 84443 | 18 AWG, 4 conductors, 500 ft. spool | 4 |
| 84444 | 18 AWG, 6 conductors, 500 ft. spool | 4 |



BX & Flexible Cable Cutter

MARS SERIES **861 & 790**

BX & Flexible Cable Cutter

Cuts BX, MC, AC, and Liquid Tight 3/8".

Features

- High durability blade provides 2X normal wear
- Storage space for replacement blades
- 25 foot drop test
- Thumbwheel for easy blade change, no tools required
- Quick Clamp feature automatically adjusts to cable size and secures it for splitting
- Automatic release ejects cable
- Cutting depth adjustment ensures clean cuts without nicking cable

| MARS NO. | DESCRIPTION | MARS PACK | CASE QTY. |
|----------|-----------------------------------|-----------|-----------|
| 86191 | BX Armor Cutter, & 1/4" Length | 1 | 5 |
| 86192 | Replacement Blade for 86191, 3/pk | 1 | 10 |

Hand Wire Caddy

Rugged Construction, epoxy coated to reduce chipping & peeling
Holds up to 8 reels, 7" D x 5" W, or 4 reels 7" D x 6" to 10" W

| MARS NO. | DESCRIPTION | MARS PACK |
|----------|--|-----------|
| 86193 | Wire Hand Caddy, 22-1/2" L x 13-1/2" W x 9-1/2" H | 1 |

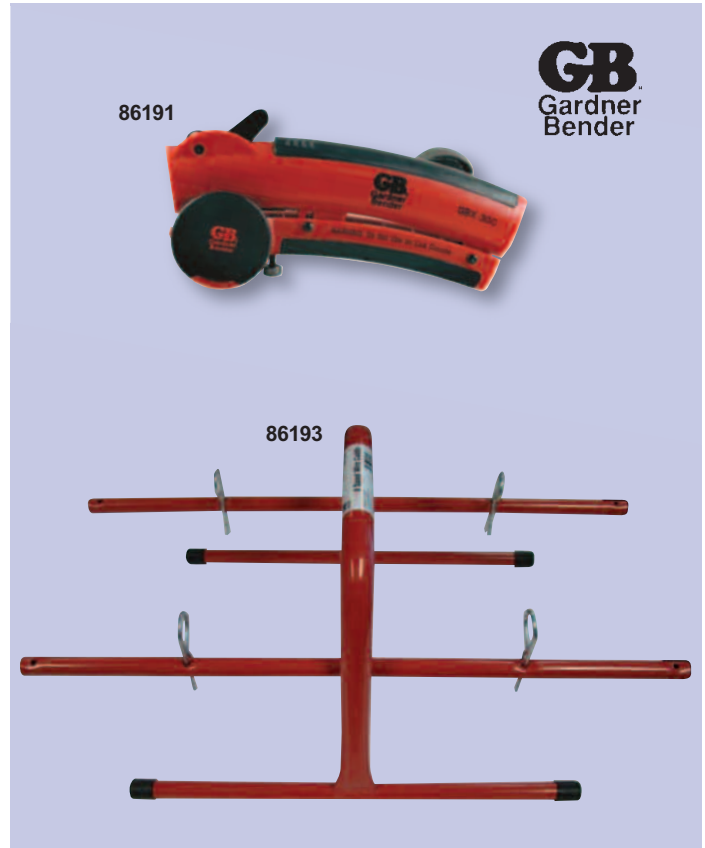

GB
Gardner
Bender

86191

86193

SERVICE & INSTALLATION



Wire Markers

MARS SERIES **256**

Adhesive Wire Markers

Wire marker dispenser measures 3" x 6" and holds 10 tape rolls at once. Rugged, sturdy case fits in your pocket. Durable long lasting tapes are excellent for wire, pipe and conduit identification.

Wire marker booklets contain 10 pages each. Plastic impregnated cloth marker resists abrasion, moisture, dirt and oil. Markers are 1-1/2" in length and can be separated into half-length sizes.

| MARS NO. | DESCRIPTION | MFG. NO. | MARS PACK | CASE QTY. |
|----------|------------------------------------|----------|-----------|-----------|
| 25920 | Wire marker dispenser, 0-9 legends | 42-301 | 1 | 5 |
| 25921 | Wire marker book, 0-9 legends | 44-101 | 5 | 5 |
| 25922 | Wire marker book, A-Z legends | 44-102 | 5 | 5 |
| 25923 | Wire marker book, 1-45 legends | 44-103 | 5 | 5 |



IDEAL

25920

25923

Light Bulbs

MARS SERIES **791**



SERVICE & INSTALLATION

Appliance Bulbs - 130 Volt

| MARS NO. | DESCRIPTION | MFG. NO. | CASE QTY. |
|----------|------------------------------------|----------|-----------|
| 79183 | 25W clear, intermediate screw base | 25T61/2 | 25 |
| 79185 | 25W clear, intermediate base | 25T8N | 25 |
| 79188 | 40W clear, intermediate base | 40T61/2 | 25 |

Pilot And Indicator Bulbs - 130 Volt

| MARS NO. | DESCRIPTION | MFG. NO. | CASE QTY. |
|----------|----------------------------------|----------|-----------|
| 79193 | 7W clear, candelabra, screw base | 7C7 | 25 |

Rough Service Bulbs 130 Volt

MARS supplies 130V rough service, 130V rough service shatterproof coated, and 120V long life general service light bulbs. The 130V design provides an extended life cycle of filament and increases energy savings.

| MARS NO. | DESCRIPTION | MARS PACK | CASE QTY. |
|----------|--------------------|-----------|-----------|
| 79171 | 50 watt 130V bulb | 6 | 120 |
| 79172 | 75 watt 130V bulb | 6 | 120 |
| 79173 | 100 watt 130V bulb | 6 | 120 |

Rough Service Coated Shatterproof Bulbs 130 Volt

MARS supplies 130V rough service, 130V rough service shatterproof coated, and 120V long life general service light bulbs. The 130V design provides an extended life cycle of filament and increases energy savings.

| MARS NO. | DESCRIPTION | MARS PACK | CASE QTY. |
|----------|--------------------|-----------|-----------|
| 79175 | 75 watt 130V bulb | 6 | 120 |
| 79176 | 100 watt 130V bulb | 6 | 120 |

General Service Bulbs - 120 Volt

| MARS NO. | DESCRIPTION | MARS PACK | CASE QTY. |
|----------|--------------------|-----------|-----------|
| 79177 | 60 watt 120V bulb | 120 | 120 |
| 79178 | 75 watt 120V bulb | 120 | 120 |
| 79179 | 100 watt 120V bulb | 120 | 120 |





Outlet Boxes

MARS SERIES **849**

4" Octagon Steel Boxes

| MARS NO. | DESCRIPTION | MARS PACK | CASE QTY. |
|----------|---------------------------|-----------|-----------|
| 84931 | 2-1/8" D 1/2" & 3/4" K.O. | 1 | 25 |
| 84932 | 1-1/2" D 1/2" K.O. | 1 | 25 |

Square Steel Boxes

| MARS NO. | DESCRIPTION | MARS PACK | CASE QTY. |
|----------|-------------------------------------|-----------|-----------|
| 84936 | 4", 2-1/2"D 1/2" & 3/4" K.O. | 1 | 25 |
| 84937 | 4", 1-1/2"D 1/2" K.O. | 1 | 25 |
| 84938 | 4", 1-1/2"D 1/2" & 3/4" K.O. | 1 | 25 |
| 84939 | 4", 1-1/4"D 1/2" K.O. | 1 | 25 |
| 84943 | 4-11/16", 2-1/8" D 1/2" & 3/4" K.O. | 1 | 25 |

2-1/8" x 4" Steel Utility Boxes

| MARS NO. | DESCRIPTION | MARS PACK | CASE QTY. |
|----------|-------------------|-----------|-----------|
| 84947 | 1-1/2"D 1/2" K.O. | 1 | 25 |
| 84948 | 1-7/8"D 1/2" K.O. | 1 | 25 |
| 84949 | 2-1/8"D 1/2" K.O. | 1 | 25 |
| 84950 | 1-7/8"D 3/4" K.O. | 1 | 25 |

Steel Extension Rings

| MARS NO. | DESCRIPTION | MARS PACK | CASE QTY. |
|----------|-----------------------------------|-----------|-----------|
| 84952 | 1-1/2"D 1/2" & 3/4" K.O. (4" sq.) | 1 | 25 |
| 84954 | 1-7/8"D 1/2" K.O. (utility) | 1 | 25 |

Square Steel Covers

| MARS NO. | DESCRIPTION | MARS PACK | CASE QTY. |
|----------|--|-----------|-----------|
| 84962 | 4", flat blank | 1 | 25 |
| 84963 | 4", 1/2" depth, single flush | 1 | 25 |
| 84964 | 4", flat, 1/2" K.O. in center | 1 | 25 |
| 84965 | 4", 1/2" raised, single toggle switch | 1 | 25 |
| 84966 | 4", 1/2" raised, 1 duplex receptacle | 1 | 25 |
| 84967 | 4", 1/2" raised, 2 toggle switch | 1 | 25 |
| 84968 | 4", 1/2" raised, 1 toggle sw. & 1 dup. recept. | 1 | 25 |
| 84969 | 4", 1/2" raised, 2 duplex receptacle | 1 | 25 |

2-1/8" x 4" Steel Utility Box Covers

| MARS NO. | DESCRIPTION | MARS PACK | CASE QTY. |
|----------|--------------------------------|-----------|-----------|
| 84987 | Duplex receptacle | 1 | 25 |
| 84988 | Toggle switch | 1 | 25 |
| 84989 | Blank | 1 | 25 |
| 84990 | Blank with 1/2" K.O. in center | 1 | 25 |
| 84991 | Single receptacle | 1 | 25 |

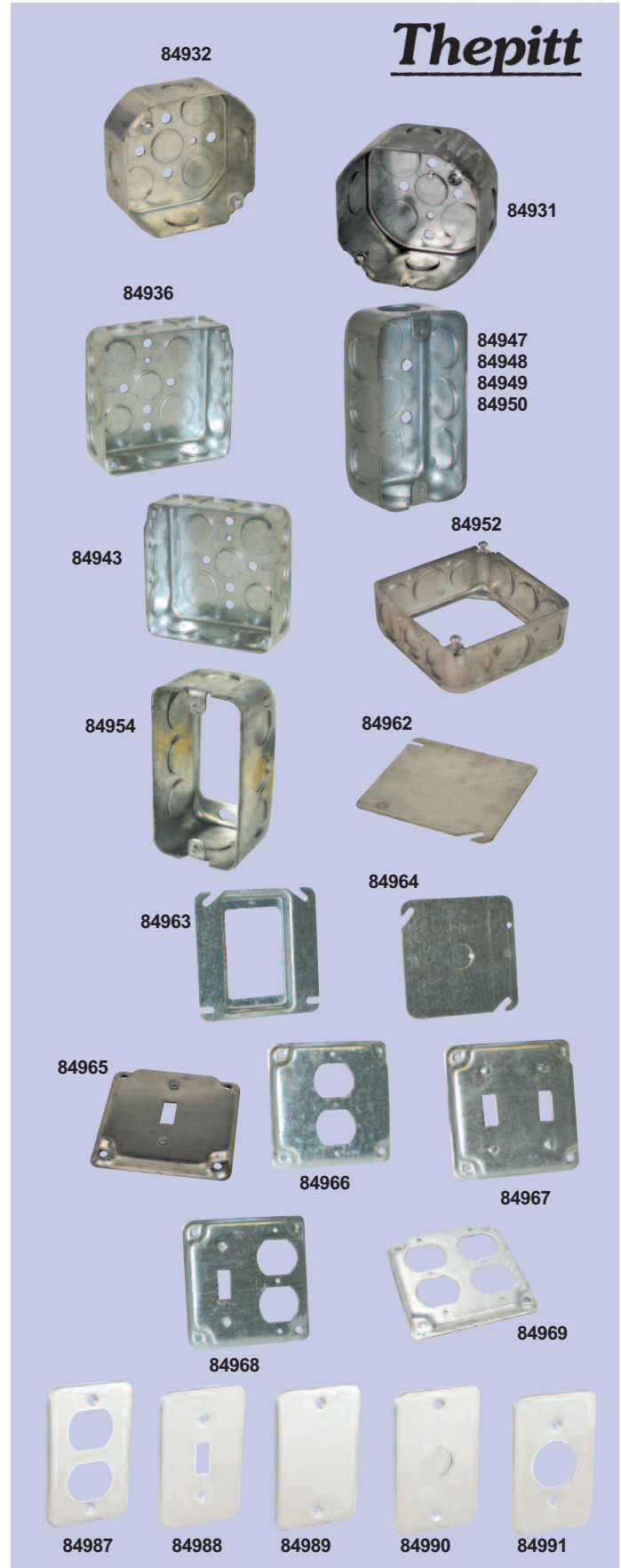

SERVICE & INSTALLATION



The largest selection of motors, components and accessories for the HVAC/R Industry

Weatherproof & PVC Outlet Boxes

MARS SERIES **849**



SERVICE & INSTALLATION

One Gang - Weatherproof Outlet Boxes

| MARS NO. | DESCRIPTION | MARS PACK | CASE QTY. |
|----------|----------------------------|-----------|-----------|
| 85901 | Three 1/2" holes with lugs | 1 | 50 |
| 85902 | Three 3/4" holes with lugs | 1 | 50 |
| 85904 | Five 1/2" holes with lugs | 1 | 50 |

Two Gang - Weatherproof Outlet Boxes

| MARS NO. | DESCRIPTION | MARS PACK | CASE QTY. |
|----------|----------------------------|-----------|-----------|
| 85910 | Three 1/2" holes with lugs | 1 | 10 |
| 85911 | Three 3/4" holes with lugs | 1 | 10 |

Self Closing GFCI Weatherproof Covers

| MARS NO. | DESCRIPTION | MARS PACK | CASE QTY. |
|----------|-------------------------------|-----------|-----------|
| 85932 | One gang for vertical devices | 1 | 10 |

Self Closing Weatherproof Covers

| MARS NO. | DESCRIPTION | MARS PACK | CASE QTY. |
|----------|---|-----------|-----------|
| 85939 | One gang vertical for single receptacle, or switch | 1 | 50 |
| 85940 | One gang for for duplex receptacle, switches or combo devices | 1 | 50 |

Weatherproof Blank Covers

| MARS NO. | DESCRIPTION | MARS PACK | CASE QTY. |
|----------|---------------------------------|-----------|-----------|
| 85950 | One gang for vertical devices | 1 | 25 |
| 85951 | Two gang with gasket and screws | 1 | 10 |

4" Octagon Steel COVERS

| MARS NO. | DESCRIPTION | MARS PACK | CASE QTY. |
|----------|-------------|-----------|-----------|
| 84980 | Flat blank | 1 | 25 |

Emergency Switch Cover Labels

| MARS NO. | DESCRIPTION | MARS PACK | CASE QTY. |
|----------|--------------------------------------|-----------|-----------|
| 84901 | Oil burner switch label; 4" x 2 1/8" | 10 | 1 |
| 84902 | Gas burner switch label; 4" x 2 1/8" | 10 | 1 |

PVC Switch Boxes - Angles Nails

| MARS NO. | DESCRIPTION | MARS PACK |
|----------|----------------------------------|-----------|
| 84910 | 16 cubic content inches, 2 1/2"D | 100 |

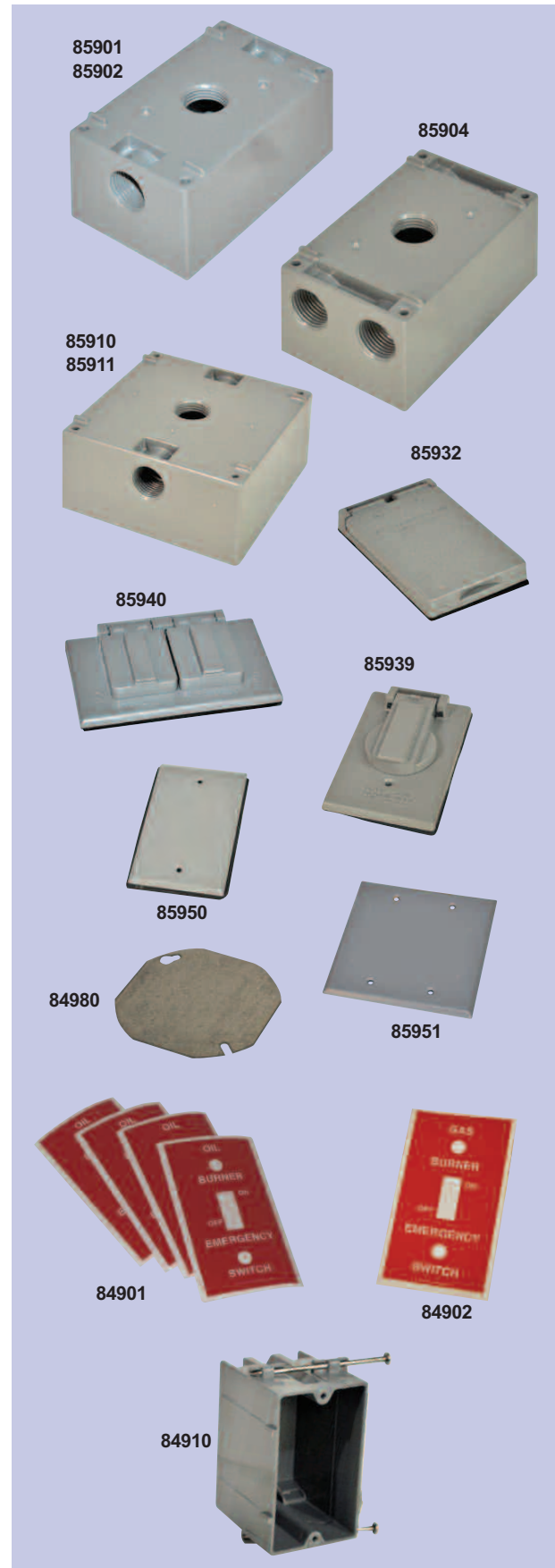



Electrical Fittings

MARS SERIES **850**

Electrical Fittings-EMT Type-Carded

| MARS NO. | DESCRIPTION | CASE QTY. |
|----------|--------------------------------------|-----------|
| 85325 | 1/2" EMT set screw connector, 3/cd | 10 |
| 85115 | 1/2" EMT set screw connector, bulk | 50 |
| 85326 | 3/4" EMT set screw connector, 2/cd | 5 |
| 85327 | 1/2" EMT set screw coupling, 2/cd | 10 |
| 85329 | 1/2" EMT compression connector, 3/cd | 10 |
| 85330 | 3/4" EMT compression connector, 2/cd | 5 |
| 85332 | 1/2" EMT compression coupling, 3/cd | 10 |
| 85333 | 3/4" EMT compression coupling, 2/cd | 5 |
| 85335 | 1/2" EMT one-hole strap, 5/cd | 10 |
| 85336 | 3/4" EMT one-hole strap, 4/cd | 10 |
| 85302 | 3/4" EMT one-hole strap, bulk | 100 |
| 85337 | 1" EMT one-hole strap, 2/cd | 10 |
| 85338 | 1 1/4" EMT one hole strap, 4/polybag | 20 |
| 85306 | 1/2" rigid IMC strap, bulk | 100 |
| 85307 | 3/4" rigid IMC strap, bulk | 100 |
| 85308 | 1" rigid IMC strap, bulk | 50 |
| 85345 | 1/2" EMT pull elbows, 1/cd | 10 |
| 85347 | 1/2" EMT two-hole strap, 5/cd | 10 |
| 85348 | 3/4" EMT two-hole strap, 4/cd | 10 |
| 85349 | 1" EMT two-hole strap, 2/cd | 10 |

Electrical Fittings-Rigid Conduit-Carded

| MARS NO. | DESCRIPTION | CASE QTY. |
|----------|---|-----------|
| 85355 | 1/2" rigid conduit offset, threaded, 2/cd | 10 |
| 85356 | 3/4" rigid conduit offset, threaded, 1/cd | 5 |
| 85359 | 1/2" rigid conduit locknut, 5/cd | 10 |
| 85360 | 3/4" rigid conduit locknut, 5/cd | 10 |
| 85364 | 3/4" x 1/2" reducing washer, 4/cd | 10 |
| 85365 | 1" x 1/2" reducing washer, 4/cd | 10 |
| 85366 | 1" x 3/4" reducing washer, 4/cd | 10 |
| 85279 | 1 1/4" x 3/4" reducing washer, bulk | 50 |
| 85280 | 1 1/4" x 1" reducing washer, bulk | 50 |
| 85281 | 1 1/2" x 1/2" reducing washer, bulk | 50 |
| 85282 | 1 1/2" x 3/4" reducing washer, bulk | 50 |
| 85284 | 2" x 3/4" reducing washer, bulk | 25 |
| 85374 | 1/2" - 1" ground clamps, 1/cd | 10 |
| 85375 | 1/2" plastic staples, 15/cd | 10 |
| 85377 | 1/2" KO seals, 4/cd | 10 |
| 85378 | 3/4" KO seals, 4/cd | 10 |

Electrical Fittings-BX/Romex/Armored-Carded

| MARS NO. | DESCRIPTION | CASE QTY. |
|----------|---|-----------|
| 85386 | 1/2" arm./flex. squeeze connector, 2/cd | 5 |
| 85387 | 3/4" arm./flex. squeeze connector, 2/cd | 5 |
| 85389 | 3/8" arm./flex. 90° squeeze conn, 2/cd | 10 |
| 85402 | 3/8" arm./flex. 90° squeeze conn, bulk | 50 |
| 85390 | 1/2" arm./flex. 90° squeeze conn, 1/cd | 5 |
| 85155 | 1/2" arm./flex. 90° squeeze conn, bulk | 25 |
| 85156 | 3/4" arm./flex. 90° squeeze conn, bulk | 10 |
| 85392 | 3/8" BX/Greenfield set screw conn, 4/cd | 10 |
| 85393 | 1/2" BX/Greenfield set screw conn, 1/cd | 10 |
| 85395 | 3/8" arm./flex. duplex connector, 1/cd | 5 |
| 85175 | 3/8" arm./flex. duplex connector, bulk | 25 |
| 85396 | 3/8" BX/MC/Romex connector, 3/cd | 10 |
| 85403 | 3/8" BX/MC/Romex connector, bulk | 100 |
| 85397 | 3/8" Romex squeeze connector, 4/cd | 10 |
| 85185 | 3/8" Romex squeeze connector, bulk | 100 |
| 85398 | 3/4" Romex squeeze connector, 2/cd | 10 |
| 85186 | 3/4" Romex squeeze connector, bulk | 25 |
| 85399 | 1" Romex squeeze connector, 2/bag | 20 |
| 85187 | 1 1/2" Romex squeeze connector, bulk | 50 |
| 85188 | 2" Romex squeeze connector, bulk | 50 |



SERVICE & INSTALLATION



The largest selection of motors, components and accessories for the HVAC/R Industry

Electrical Fittings

MARS SERIES **850**



Liquid-Tight Flexible Metallic Fittings

| MARS NO. | DESCRIPTION | MARS PACK | CASE QTY. |
|----------|----------------------------------|-----------|-----------|
| 85000 | 3/8" straight metallic connector | 25 | 250 |
| 85001 | 1/2" straight metallic connector | 20 | 250 |
| 85002 | 3/4" straight metallic connector | 10 | 100 |
| 85003 | 1" straight metallic connector | 5 | 50 |
| 85004 | 3/8" 90° metallic connector | 10 | 100 |
| 85005 | 1/2" 90° metallic connector | 10 | 100 |
| 85006 | 3/4" 90° metallic connector | 10 | 100 |
| 85007 | 1" 90° metallic connector | 5 | 50 |

Liquid-Tight PVC Flexible Non-Metallic Fittings

| MARS NO. | DESCRIPTION | MARS PACK | CASE QTY. |
|----------|--------------------------------------|-----------|-----------|
| 85015 | 3/8" straight non-metallic connector | 25 | 250 |
| 85016 | 1/2" straight non-metallic connector | 25 | 250 |
| 85017 | 3/4" straight non-metallic connector | 10 | 100 |
| 85018 | 1" straight non-metallic connector | 5 | 50 |
| 85019 | 3/8" 90° non-metallic connector | 10 | 100 |
| 85020 | 1/2" 90° non-metallic connector | 10 | 100 |
| 85021 | 3/4" 90° non-metallic connector | 10 | 100 |
| 85022 | 1" 90° non-metallic connector | 5 | 50 |

Liquid-Tight 45° PVC Connectors

Arlington's liquid-tight 45° pvc connectors are for use with non-metallic, liquid-tight conduit, type B. The 45° connector has the same smooth raceway as the 90° connector for easier pulling or pushing or wiring. These are UV rated like our other pvc fittings.

| MARS NO. | DESCRIPTION | MARS PACK | CASE QTY. |
|----------|-----------------------------------|-----------|-----------|
| 85024 | 1/2" x 45° non-metallic connector | 10 | 50 |

Liquid-Tight Screw On Connectors

This attractive one pc design allows superior liquid-tight seal & Optimum pull strength without compression nut. PVC construction produced from UV rated material for long outdoor life. Ideal for conduit assemblies & installers. "O" ring & steel locknut included.

| MARS NO. | DESCRIPTION | MARS PACK | CASE QTY. |
|----------|----------------------------|-----------|-----------|
| 84992 | 1/2" Straight Screw On | 25 | 100 |
| 84993 | 3/4" Straight Screw On | 25 | 100 |
| 84994 | 1/2" 90 Deg Sweep Screw On | 10 | 100 |
| 84995 | 3/4" 90 Deg Sweep Screw On | 10 | 100 |

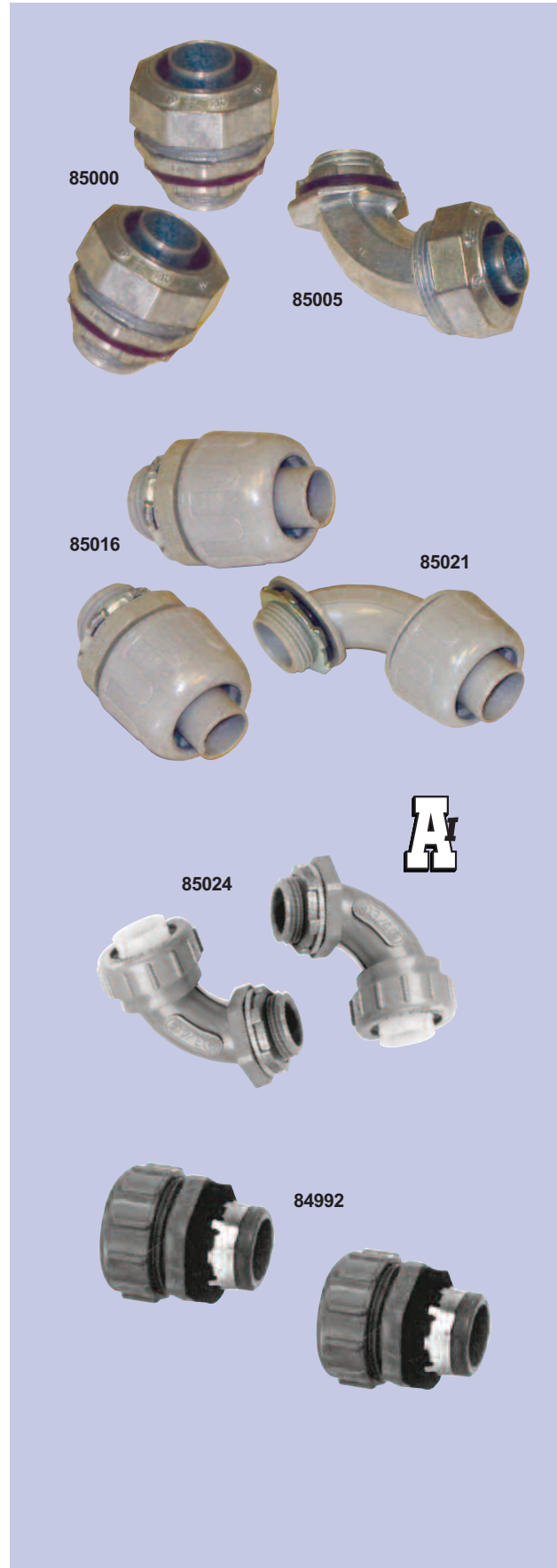

SERVICE & INSTALLATION



Appliance Cords & Cord Sets

MARS SERIES **846 & 847**

MARS Range And Dryer Receptacles

| MARS NO. | DESCRIPTION | CASE QTY. |
|----------|--|-----------|
| 84700 | 30a-250V, surface mount dryer receptacle | 10 |
| 84701 | 30a-250V, flush mount dryer receptacle | 25 |
| 84702 | 50a-250V, surface mount range receptacle | 10 |
| 84699 | 30a-250V, srfc. mnt. dryer recept., 3P4W, ground | 10 |
| 84705 | 50a-250V, srfc. mnt. range recept., 3P4W, ground | 10 |



MARS Major Appliance Extension Cords, UL Listed

| MARS NO. | DESCRIPTION | CASE QTY. |
|----------|--|-----------|
| 84625 | 15a-125V, 14/3 spt, 3 foot appliance ext. | 30 |
| 84626 | 15a-125V, 14/3 spt, 6 foot appliance ext. | 25 |
| 84627 | 15a-125V, 14/3 spt, 9 foot appliance ext. | 15 |
| 84629 | 15a-125V, 14/3 spt, 15' appl. ext., non UL | 12 |
| 84633 | 20a-250V, 12/3 spt, 6 foot appliance ext. | 25 |

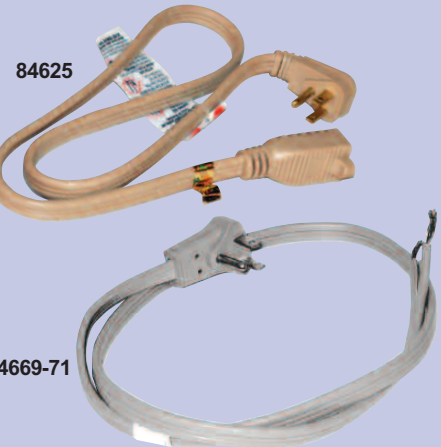

MARS Pigtails/Replacement Cords - 13 Amp, 125V

| MARS NO. | DESCRIPTION | CASE QTY. |
|----------|-------------------------------|-----------|
| 84669 | 16/3 pigtail 3 ft. SPT-3 RT | 50 |
| 84670 | 16/3 pigtail 6 ft. SPT-3 RT | 50 |
| 84671 | 16/3 pigtail 8 ft. SPT-3 RT | 50 |
| 84673 | 16/3 pigtail 3 ft. SPT-3 STR | 50 |
| 84674 | 16/3 pigtail 6 ft. SPT-3 STR | 50 |
| 84679 | 16/3 pigtail 6 ft. SJT-BL STR | 50 |
| 84681 | 14/3 pigtail 6 ft. SJT-BL STR | 50 |

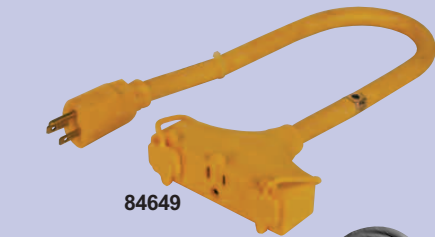

Power Block Type Extension Cords, 15a-125V - UL listed

| MARS NO. | DESCRIPTION | CASE QTY. |
|----------|-------------------------------------|-----------|
| 84649 | Power block ext. 12/3 sjtwa, 2 foot | 4 |

Outdoor Heavy Duty Ext. Cords, Orange - UL Listed - SJTWA

| MARS NO. | DESCRIPTION | CASE QTY. |
|----------|---------------------------------------|-----------|
| 84652 | Outdoor ext. 16/3, 13a-125V, 25 foot | 24 |
| 84653 | Outdoor ext. 14/3, 15a-125V, 25 foot | 14 |
| 84655 | Outdoor ext. 16/3, 13a-125V, 50 foot | 12 |
| 84656 | Outdoor ext. 14/3, 15a-125V, 50 foot | 10 |
| 84657 | Outdoor ext. 12/3, 15a-125V, 50 foot | 6 |
| 84658 | Outdoor ext. 16/3, 10a-125V, 100 foot | 6 |
| 84659 | Outdoor ext. 14/3, 13a-125V, 100 foot | 6 |



Trouble Lights, One Grounded Outlet - UL Listed

| MARS NO. | DESCRIPTION | CASE QTY. |
|----------|---|-----------|
| 84696 | Metal cage trouble light, 16/3, SJT, 13a, 25' | 8 |
| 84697 | Metal cage trouble light, 16/3, SJT, 13a, 50' | 6 |

Portable Lighting

| MARS NO. | DESCRIPTION | CASE QTY. |
|----------|--------------------------------|-----------|
| 84689 | 8-1/2" clamp light - 6 ft cord | 6 |



SERVICE & INSTALLATION



The largest selection of motors, components and accessories for the HVAC/R Industry

Cylinder Cradles and Strap

MARS SERIES **790**



Cylinder Cradles and Strap

Cylinder cradles make transportation of cylinders easy and safe. The cradles are made with Maximum Visibility webbing for day or night work.

- Polyester webbing meets 5000 lb min breaking strength
- Hardware meets 5000 lb min breaking strength
- Specialized designed lifting solutions
- Individually colored for easy identification
- Cylinder transportation



| MARS NO. | DESCRIPTION | MARS PACK |
|----------|--|-----------|
| 79061 | Shoulder Comfort Strap - to transport cylinders safely using Cradles | 1 |
| 79062 | Recovery Cylinder Cradle | 1 |
| 79063 | B Tank Cylinder Cradle | 1 |
| 79064 | Refrigerant Cylinder Cradle | 1 |
| 79065 | Nitrogen Cylinder Cradle | 1 |

SERVICE & INSTALLATION

Polypropylene Web Duct Strap

MARS SERIES **863**



Polypropylene Web Duct Strap

- UL 723 Flame and Smoke

| MARS NO. | DESCRIPTION | MARS PACK |
|----------|-------------------------|-----------|
| 86126 | Black 1 3/4" x 100 yds. | 24 |
| 86296 | Black 3" x 100 yds | 8 |
| 86297 | Silver 1-3/4" x 100 yds | 24 |
| 86298 | Silver 3" x 100 yds | 8 |

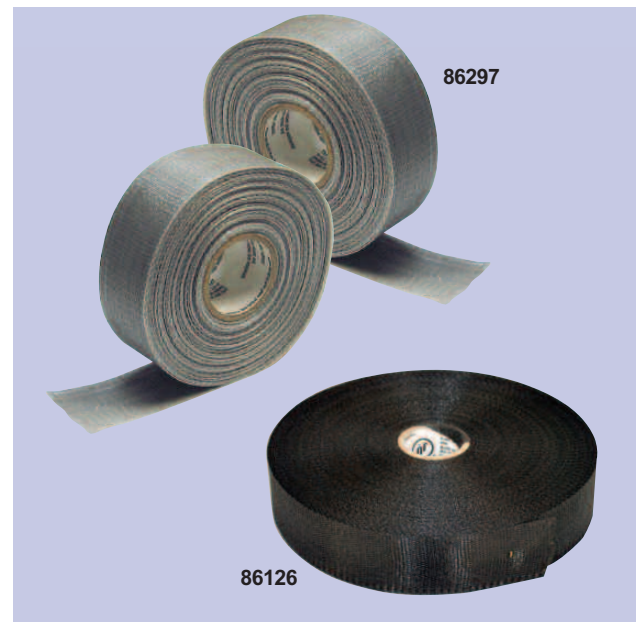

Rope, Tie Downs & Tarps

MARS SERIES **790**

Truck And Equipment Tarps

MARS equipment tarps provide a durable blue protective covering for truck beds, construction material and contractors tools.

| MARS NO. | DESCRIPTION | MARS PACK | CASE QTY. |
|----------|---------------------|-----------|-----------|
| 79115 | 8' x 10' blue tarp | 1 | 20 |
| 79116 | 12' x 12' blue tarp | 1 | 12 |

Molded Rubber Straps

Molded rubber straps are made of high quality black rubber. Sturdy hooks will not loosen.

| MARS NO. | DESCRIPTION | MARS PACK |
|----------|-------------------|-----------|
| 79591 | 19" length - bulk | 48 |
| 79592 | 24" length - bulk | 24 |
| 79593 | 35" length - bulk | 24 |

Nylon Tie-Down Straps And Tow Straps - Clamshell Pkg

| MARS NO. | DESCRIPTION | CASE QTY. |
|----------|---|-----------|
| 79596 | 10' universal tie down with non-slip cambuckle and vinyl coated steel hooks | 12 |
| 79598 | 15' ratchet tie down with "J" hooks & "D" rings | 12 |

Truck Rope-Polypropylene - USA

MARS truck rope is made of a polypropylene construction. All ropes are made in the USA. Applications range from hoisting, truck bed material tie down, job site tie off and a wide variety of other uses. MARS #79059 and #79060 include handy safety hook.

| MARS NO. | DESCRIPTION | MARS PACK | CASE QTY. |
|----------|--|-----------|-----------|
| 79053 | 3/8" x 50' yellow | 1 | 12 |
| 79055 | 3/8" x 50' blk/orange | 1 | 12 |
| 79056 | 3/8" x 100' blk/orange | 1 | 12 |
| 79057 | 1/2" x 50' blk/orange | 1 | 12 |
| 79059 | 3/8" x 50' blk/orange with safety hook | 1 | 12 |
| 79060 | 1/2" x 50' blk/orange with safety hook | 1 | 12 |

Canvas Drop Cloths

| MARS NO. | DESCRIPTION | MARS PACK | CASE QTY. |
|----------|--|-----------|-----------|
| 79118 | 9 Oz. Canvas Drop Cloth 9 x 12, 3 Mil | 1 | 6 |
| 79119 | 6 Oz. Canvas Drop Cloth 12 x 15, 1 Mil | 1 | 4 |
| 79120 | 6 Oz. Canvas Drop Cloth 4 x 12, 2 Mil | 1 | 12 |



SERVICE & INSTALLATION

Duct Straps, Pipe Hangers & Hooks

MARS SERIES **863**



Galvanized Duct Straps

The perforated, galvanized duct strap has 1/4" and 9/64" holes for nails & bolts.

| MARS NO. | DESCRIPTION | MARS PACK | CASE QTY. |
|----------|-------------------------------|-----------|-----------|
| 86025 | 28 gauge 3/4" x 10' RL bulk | 100 | 100 |
| 86026 | 28 gauge 3/4" x 50' RL boxed | 1 | 1 |
| 86027 | 28 gauge 3/4" x 100' RL boxed | 1 | 1 |
| 86031 | 20 gauge 3/4" x 10' RL bulk | 100 | 100 |
| 86032 | 20 gauge 3/4" x 25' RL boxed | 6 | 6 |
| 86033 | 20 gauge 3/4" x 50' RL boxed | 1 | 1 |

Duct Straps And Hangers

The wire duct strap is used for all square duct run below the joist. Hammers right into duct and joist. No nails, screws or rivets are needed.

The pipe hanger is the fastest way to install round 5", 6" or 7" heating pipes below the joist. No nails needed.

Duct straps are for use on all square ducts run below the joist.

The DWV pipe hangers are designed for rapid installation of both ABS and PVC plastic DWV piping with standard flat head galvanized nails. Galvanized steel construction.

| MARS NO. | DESCRIPTION | MARS PACK | CASE QTY. |
|----------|--------------------------|-----------|-----------|
| 86037 | Duct strap DS 3 | 100 | 100 |
| 86040 | DWV pipe hanger 2" x 12" | 50 | 50 |
| 86041 | DWV pipe hanger 3" x 12" | 50 | 50 |

Mechanics Hanging Wire - Plasta-Reel™

MARS presents hanging wire on a Handi-Reel™. This convenient reel unwinds easily. Hangs over post or peg on truck bed, from a 2 x 4 or nail. Plasta-Reel™ prevents tangling. This polyethylene reel is smooth and safe to handle. Never blisters, burns or cuts the skin as metal might do! 4,150 ft. per roll.

| MARS NO. | DESCRIPTION | MARS PACK | CASE QTY. |
|----------|----------------------------|-----------|-----------|
| 84418 | 18 gauge Black Ann 5 lbs. | 50 | 500 |
| 84419 | 18 gauge Galvanized 5 lbs. | 50 | 500 |

MARS Plastic Hanger Strap

- Flexible, non-conductive. 3/4" wide x .050 thick 100' roll
- 1/8" holes spaced every 3/4"
- Uses: pipe/duct hanging
- Convenient dispenser box keeps roll neat and tidy

| MARS NO. | DESCRIPTION | MARS PACK | CASE QTY. |
|----------|-------------------|-----------|-----------|
| 86177 | Hanger strap 100L | 1 | 1 |

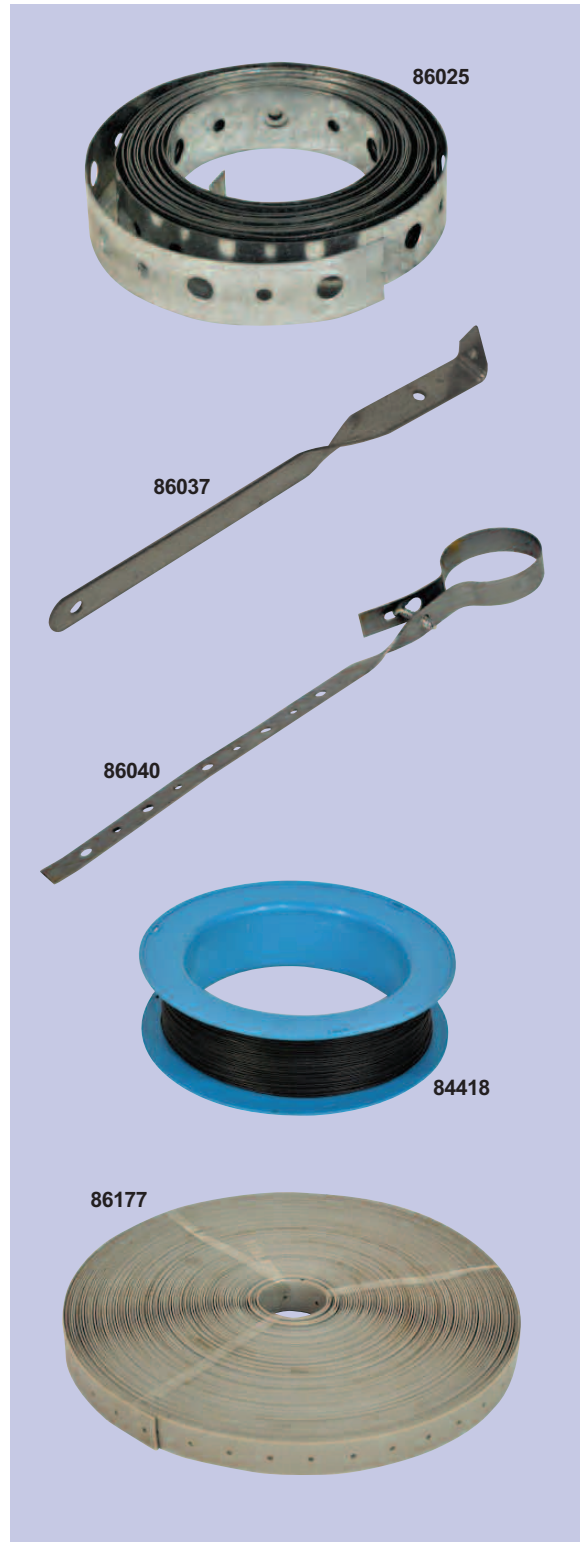



Wire Ties

MARS SERIES **865**

MARS Wire Ties, 100 Packs

MARS nylon wire ties and duct straps are available in a wide variety of styles, color and tensile strengths. They range in sizes from 4" to 36" with tensile strengths from 18 lbs. to 175 lbs. All MARS wire ties and duct straps feature the bent tip design for ease and insertion.

| MARS NO. | DESCRIPTION | | | MARS PACK | |
|----------|-------------|---------|-------------|-----------------------|---|
| 86100 | 4" | natural | standard | 3/4" dia. x 18 lbs. | 1 |
| 86101 | 4" | black | standard | 3/4" dia. x 18 lbs. | 1 |
| 86104 | 5.5" | natural | standard | 1 1/4" dia. x 40 lbs. | 1 |
| 86105 | 5.5" | black | standard | 1 1/4" dia. x 40 lbs. | 1 |
| 86106 | 8" | natural | standard | 1 3/4" dia. x 40 lbs. | 1 |
| 86107 | 8" | black | standard | 1 3/4" dia. x 40 lbs. | 1 |
| 86151 | 8" | blue | standard | 2" dia. x 50 lbs. | 1 |
| 86108 | 11" | natural | standard | 3" dia. x 50 lbs. | 1 |
| 86109 | 11" | black | standard | 3" dia. x 50 lbs. | 1 |
| 86153 | 14" | black | standard | 4" dia. x 120 lbs. | 1 |
| 86110 | 14.5" | natural | standard | 4" dia. x 50 lbs. | 1 |
| 86111 | 14.5" | black | standard | 4" dia. x 50 lbs. | 1 |
| 86112 | 6" | natural | screw mount | 1 1/4" dia. x 30 lbs. | 1 |
| 86113 | 6" | black | screw mount | 1 1/4" dia. x 30 lbs. | 1 |
| 86114 | 7.5" | natural | screw mount | 1 3/4" dia. x 50 lbs. | 1 |
| 86115 | 7.5" | black | screw mount | 1 3/4" dia. x 50 lbs. | 1 |
| 86155 | 11" | black | screw mount | 3" dia. x 50 lbs. | 1 |
| 86156 | 14" | black | screw mount | 4" dia. x 50 lbs. | 1 |
| 86157 | 14" | natural | screw mount | 4" dia. x 50 lbs. | 1 |

MARS Wire Ties, Bulk Packs

| MARS NO. | DESCRIPTION | | | MARS PACK | |
|----------|-------------|---------|----------|---------------------------------|---|
| 86116 | 8" | natural | standard | 1 3/4" dia. x 40 lbs. (1000 pk) | 1 |
| 86117 | 8" | black | standard | 1 3/4" dia. x 40 lbs. (1000 pk) | 1 |
| 86152 | 8" | blue | standard | 2" dia. x 50 lbs. (1000 pk) | 1 |
| 86118 | 11" | natural | standard | 3" dia. x 50 lbs. (500 pk) | 1 |
| 86119 | 11" | black | standard | 3" dia. x 50 lbs. (500 pk) | 1 |
| 86120 | 14.5" | natural | standard | 4" dia. x 50 lbs. (500 pk) | 1 |
| 86122 | 14.5" | black | standard | 4" dia. x 50 lbs. (500 pk) | 1 |

MARS Wire Ties, Assortment Packs

| MARS NO. | DESCRIPTION | | | MARS PACK |
|----------|-------------|----------|-----------------------------|-----------|
| 86123 | (100) 4" | (100) 8" | natural assortment | 1 |
| 86124 | (100) 8" | (50) 11" | natural assortment | 1 |
| 86125 | (200) 5" | (200) 8" | (50) 11" natural assortment | 1 |

MARS Duct Straps, 175 lbs., 50 Packs

| MARS NO. | DESCRIPTION | | | MARS PACK |
|----------|--------------------------|----------|---------|-----------|
| 86127 | 24" duct strap for up to | 6" duct | natural | 1 |
| 86128 | 36" duct strap for up to | 10" duct | natural | 1 |
| 86129 | 48" duct strap for up to | 14" duct | natural | 1 |
| 86102 | 24" duct strap for up to | 6" duct | black | 1 |
| 86103 | 36" duct strap for up to | 10" duct | black | 1 |



SERVICE & INSTALLATION

Utility Knife

MARS SERIES **256 & 274**



Ready Utility Knife

- Featuring the QUICKEST blade change in the industry.
- Rugged all steel construction
- Folds to a very compact size
- Easily and quickly change blades with the push of a button
- Set includes knife, nylon carrying case, and 5 standard blades

| MARS NO. | DESCRIPTION | MARS PACK | CASE QTY. |
|----------|---------------|-----------|-----------|
| 25784 | Utility knife | 1 | 48 |

MARS Knife Sharpener

Finally, a Knife Sharpener anyone can use! No more messy oils or stones. Sharpen knives in about 10 seconds (even serrated knives), cleavers, axes, machetes, and many other cutting tools. The full length finger guard protects your fingers. Sharpening blades are Diamond Honed Tungsten Carbide for years of reliable use. AccuSharp Knife Sharpeners will not rust and can be cleaned with soap and water or in the dishwasher.

| MARS NO. | DESCRIPTION | CASE QTY. |
|----------|----------------------|-----------|
| 27520 | MARS Knife Sharpener | 12 |

Cable Tie Tool

Cable Tie Tools are economical, lightweight and easy to use.

Ideal for heavy duty ties and duct straps. Constructed from high grade steel.

- Heavy duty construction
- Installer controls tensioning
- Squeeze to cut excess

| MARS NO. | DESCRIPTION | LENGTH | COLOR | BAG | CASE QTY. |
|----------|-------------|---------|-------|-----|-----------|
| 25683 | | 175 lbs | Red | 1 | 100 |

Ready



Access Fittings & Service Valves

MARS SERIES **654**

Braze-On Service Valves - Saddle Valves

Braze-on self-piercing copper service valves are widely used and easily installed on a charged line. After brazing the saddle portion onto the line, the steel pin with valve core penetrates the line and is locked into place simply by tightening the cap. Available in sizes from 1/4" to 1-1/8".

| MARS NO. | DESCRIPTION | MARS PACK |
|----------|----------------------|-----------|
| 65425 | 1/4" qty 6 per bag | 1 |
| 65426 | 5/16" qty 6 per bag | 1 |
| 65427 | 3/8" qty 6 per bag | 1 |
| 65428 | 1/2" qty 4 per bag | 1 |
| 65429 | 5/8" qty 3 per bag | 1 |
| 65430 | 3/4" qty 2 per bag | 1 |
| 65431 | 7/8" qty 2 per bag | 1 |
| 65432 | 1 1/8" qty 2 per bag | 1 |

Economy Line Service Valves - Extended Copper Tubes

- With valve core & flat cap (#65408)
- 1/4" male flare access fitting

| MARS NO. | DESCRIPTION | MARS PACK |
|----------|---|-----------|
| 65438 | 3/16" copper tube extension, qty. 6 / bag | 1 |
| 65439 | 1/4" copper tube extension, qty. 6 / bag | 1 |
| 65440 | 5/16" copper tube extension, qty. 6 / bag | 1 |
| 65441 | 3/8" copper tube extension, qty. 6 / bag | 1 |
| 65442 | 1/8" copper tube extension, qty. 6 / bag | 1 |
| 65434 | 5/16" copper tube extension, bulk | 100 |
| 65435 | 3/8" copper tube extension, bulk | 100 |
| 65436 | 3/16" copper tube extension, bulk | 100 |
| 65437 | 1/4" copper tube extension, bulk | 100 |
| 65443 | 1/8" copper tube extension, bulk | 100 |

Copper Tees - 1/4" Male Flare

Copper tees have bodies brazed on. Using copper for the tee portion allows tubing to be attached to each end and allows using a solderless than silver solder, such as 95-5. They are to be used where two line ends have not yet been attached or where it is desirable to cut a line rather than drive a hole on an uncharged system. Copper tees save time and money. • includes valve core and flat cap (#65408).

| MARS NO. | DESCRIPTION | MARS PACK |
|----------|----------------------------------|-----------|
| 65447 | Tee for 1/4" O.D. tube (2 bag) | 1 |
| 65448 | Tee for 5/16" O.D. tube (2 bag) | 1 |
| 65449 | Tee for 3/8" O.D. tube (2 bag) | 1 |
| 65450 | Tee for 1/2" O.D. tube (2 bag) | 1 |
| 65451 | Tee for 5/8" O.D. tube (2 bag) | 1 |
| 65452 | Tee for 3/4" O.D. tube (2 bag) | 1 |
| 65453 | Tee for 7/8" O.D. tube (2 bag) | 1 |
| 65454 | Tee for 1 1/8" O.D. tube (2 bag) | 1 |

Tees Connectors

Tee connectors are used to connect controls to check oil pressure on larger compressors having positive pressure oil pumps and to check the accuracy of oil pressure gauges installed on the equipment by the manufacturer against your gauge with known accuracy.

| MARS NO. | DESCRIPTION | MARS PACK | MARS NO. | DESCRIPTION | MARS PACK |
|----------|--|-----------|----------|---|-----------|
| 65459 | 1/4" m. flare x 1/4" f. flare nut w/ depressor tip x 1/4" m. flare on the branch w/one valve core (qty. 2 per bag) | 1 | 65461 | All brass tee connector 1/4" m. flare with valve core & cap x 1/4" m. flare x 1/4" f. flare nut with depressor tip on branch (qty. 1 per bag) | 1 |
| 65460 | 1/4" m. flare with valve core x 1/4" m. flare x 1/4" f. flare nut w/ depressor tip on the branch (qty. 2 per bag) | 1 | | | |

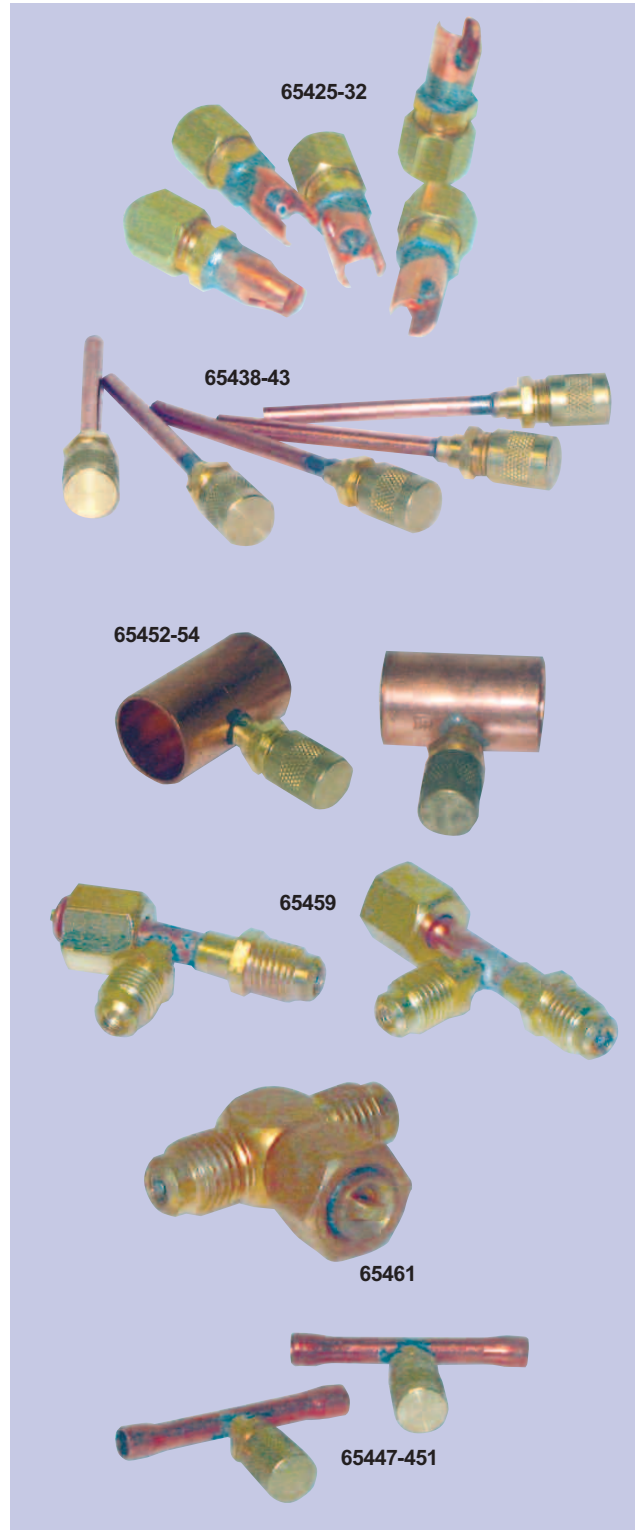

SERVICE & INSTALLATION



The largest selection of motors, components and accessories for the HVAC/R Industry

SI-55

Access Fittings & Service Valves

MARS SERIES **654**



Brass Bodies - Half Unions

MARS brass bodies have a 1/4" standard male flare above the hex. Below the hex are various threads, outside diameters and inside diameters for accepting different sizes of tubing and connections. A flat top brass cap and teflon valve core are included.

| MARS NO. | DESCRIPTION | MARS PACK |
|----------|--|-----------|
| 65401 | 1/4" MPT dry seal x 1/4" male flare 5/16" I.D. hole accommodates 5/16" O.D. tube. Qty. 2 per bag | 1 |
| 65402 | 1/8" MPT dry seal x 1/4" male flare 1/4" I.D. hole accommodates 1/4" O.D. tube. Qty. 6 per bag | 1 |
| 65403 | 1/4" male flare for 1/8" I D hole - accommodates 1/8" O.D. tube. (3/16", 1/4", 5/16" O.D. steps) Qty 6 per bag | 1 |

Brass Caps & Valve Cores

| MARS NO. | DESCRIPTION | MARS PACK |
|----------|---|-----------|
| 65408 | Round brass flat cap w/neoprene O-ring seal for 1/4" flare, qty 6 per bag | 1 |
| 65409 | Round brass cap w/ core wrench top and neoprene O-ring seal for 1/4" flare, qty 6 per bag | 1 |
| 65410 | Plastic core container - includes six valve cores and a core wrench and thread chaser | 1 |
| 65411 | Brass core remover container with wrench tip - includes three valve cores | 1 |
| 65412 | Valve core w/teflon seal, qty. 6 per bag | 1 |

Core Removal Tools With Ball Valve

MARS core removal tools are used to remove and replace valve cores in a 1/4" flare without losing refrigerant. Because it has a ball valve inside rather than a stem-type valve, the tool can be closed with just a quarter turn. This convenient compact size tool is ideal for working in close quarters.

| MARS NO. | DESCRIPTION | MARS PACK |
|----------|--|-----------|
| 65418 | Core removal tool | 1 |
| 65419 | Core removal tool w/ 1/4" male flare side port | 1 |

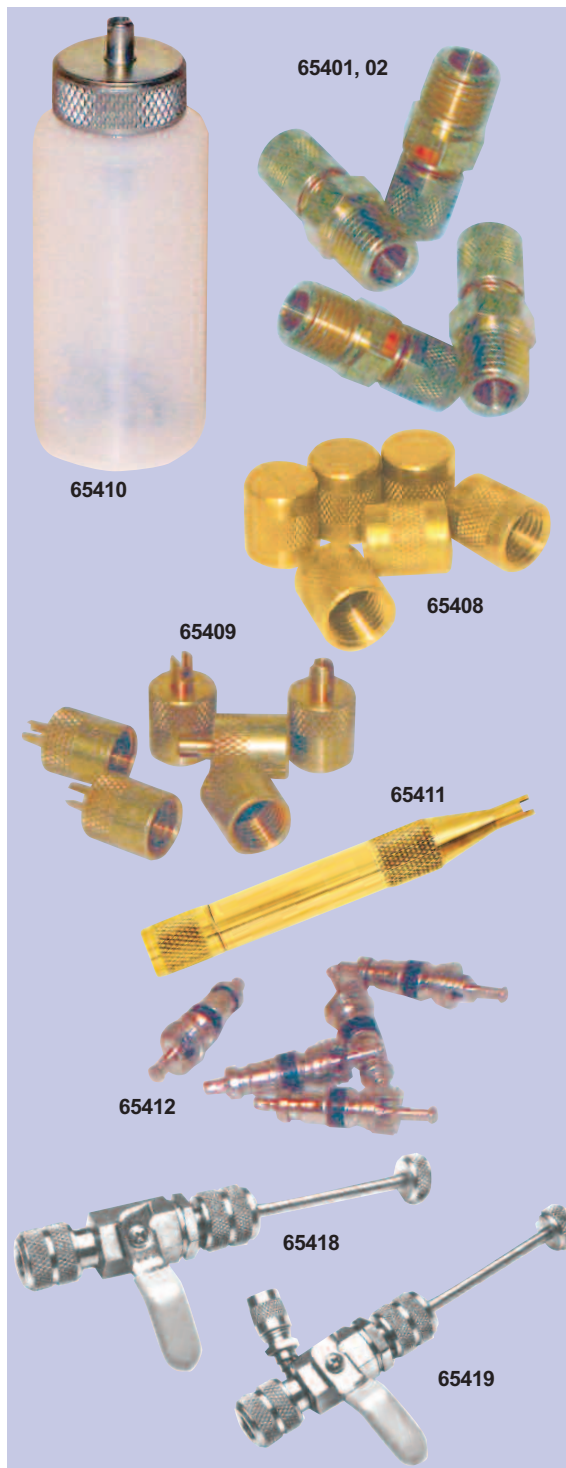



Chemicals

Thawzone liquid dehydrant chemically "dries" all refrigerants (R12, R22, R134, etc.), methyl chloride, and methylene chloride. Thawzone frees frozen systems due to moisture in five minutes. It prevents refreezing, does not leave any residue, does not contain any dissolved solids or methanol, and works with or without solid dryers. Available in 1 oz., 4 oz. and 16 oz. plastic bottles.

Leak Lock joint sealer is a soft setting pipe joint compound for sealing threaded joints, flanged joints, gasket surfaces and mating surfaces. This resin based brushable paste remains permanently flexible, adheres to internal surfaces and fills voids. It is ideal for use on metal and plastic materials subject to extreme vibrations, temperatures from -100°F (-73°C) to 400°F (204°C) full vacuums to 10,000 PSI. Leak Lock seals all refrigerants (R12, R22, R502, R134A, etc.) petroleum products, natural and manufactured gases, steam, water, air, etc. Available in 1 1/3 oz. plastic tube and 4 oz. and 1 pint brushtop plastic jars.

Red Epoxy aluminum sealer is a high performance heat cured, two part epoxy kit for patching or sealing on all metals and some plastics. Red Epoxy is cured within minutes and equipment is serviceable immediately. It is excellent for sealing threaded or unthreaded pipes and is great as a field repair kit for aluminum evaporators, coils, radiators, pipes, tanks, etc. Temperature range: -100°F (-73°C) to 300°F (149°C). Tensile strength: 600psi. working pressure tested in excess of 3000 psi. Kit includes resin & hardener. (.5 oz. tube each)

Low-Temp Gas Leak Detector is non-toxic and non-hazardous and does not contain ethylene glycol. This non-freezing, viscous florescent, bubble type gas leak detector is rated to -30°F (-34°C). The leaks appear as large strong bubbles which cling to the applied surface and are florescent under a black light. For use on hot and cold piping and equipment containing most gases such as air, natural gas, all refrigerants (R12, R134A, R22, R502, etc.) ammonia, SO₂ etc.

The mid-temp gas leak detector is non-toxic and non-hazardous. It is a viscous, fluorescent, bubble-type gas leak detector rated to 27°F (-3°C). Leaks appear as large strong bubbles which cling to the applied surface and are florescent under a black light. For use on hot and cold piping equipment containing most gases such as air, natural gas, all refrigerants (R12, R134A, R22, R502A, etc.), ammonia, SO₂ etc.

Solderlene is a high quality, paste type, non-acid soldering flux with industrial strength wetting agents to promote solder flow. For use with all low and mid temperature soft solders, both lead bearing and lead-free, on all metals except aluminum and magnesium.

Trace is a red dye trace type internal leak detector for use with mineral oil base refrigerant lubricants and hydraulic systems. Leaks show as intense red stains. Trace is non-volatile, will not sludge oil or deposit gum. Trace is soluble in the lubricant and liquid refrigerant but not the gas and travels with the lubricant. Oil separators will remove trace and should be bypassed. Trace passes through solid core dryers but the color intensity may be reduced.

| MARS NO. | DESCRIPTION | MARS PACK |
|----------|--|-----------|
| 93801 | Thawzone 1 oz. bottle | 24 |
| 93802 | Thawzone 4 oz. bottle | 12 |
| 93815 | Thawzone 16 oz. bottle | 6 |
| 93803 | Leak Lock 1 1/3 oz. tube | 12 |
| 93804 | Leak Lock 4 oz. brush top jar | 12 |
| 93805 | Leak Lock 1 pint brush top jar | 12 |
| 93806 | Red Epoxy kit .5 oz. tube | 24 |
| 93807 | Low Temp Gas Detector 8 oz. dauber bottle | 24 |
| 93808 | Low Temp Gas Detector 32 oz. trigger spray | 12 |
| 93809 | Mid-temp gas detector 8 oz. dauber bottle | 24 |
| 93810 | Mid-temp gas detector 32 oz. trigger spray | 12 |
| 93811 | Screwloose® Solderlene 4 oz. brushtop jar | 24 |
| 93812 | Solderlene 1 pint brush top jar | 12 |
| 93813 | Trace® 4 oz. bottle | 12 |
| 93814 | Trace® 16 oz. bottle | 6 |



SERVICE & INSTALLATION

Liquid Line Filter Driers

MARS SERIES **201**



MARS Liquid Line Filter Driers

The MARS Liquid Line Filter Driers are designed to offer complete protection of your refrigerant system. The desiccant block is a carefully selected blend of molecular sieve and activated alumina, providing for maximum removal of moisture, acid, and foreign materials. This molded desiccant block allows for efficient filtration and retention of solid contaminants, while insuring minimum pressure drop. The solid molded block exposes maximum surface area and provides even distribution of filtered material as the refrigerant flows through the drier. These driers are intended for use on R-134A, R-404A, R-410A, R-507, R-12, R-500, R-502

Features & Benefits:

- High moisture removal
- High organic & inorganic acid removal
- Solid block desiccant core
- For use with HCFCs, CFCs, and the lubricants that go with them
- Nickel plated SAE flare and solid copper ODF fittings
- Corrosion resistant
- Maximum working pressure 600 PSIG
- Minimum burst pressure 2500 PSIG
- UL & CSA listed

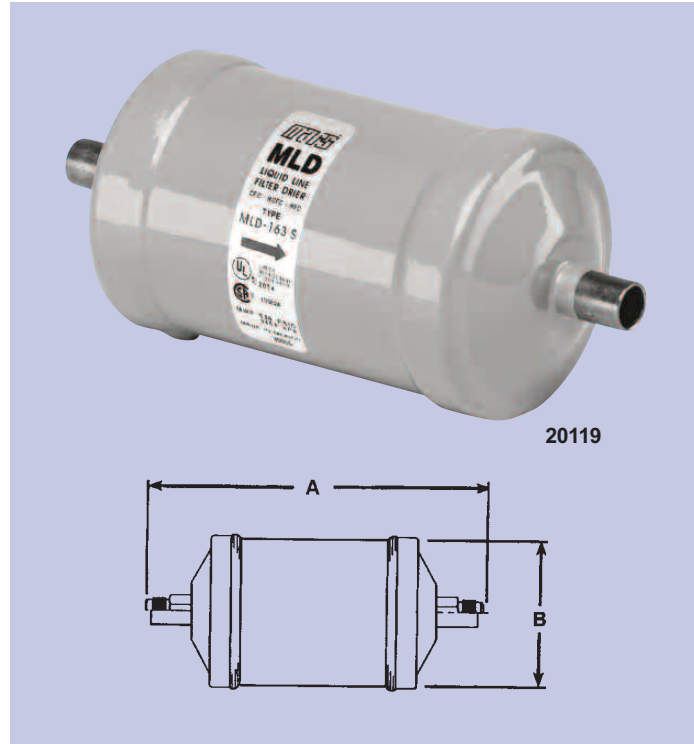

SERVICE & INSTALLATION

| MARS NO. | MODEL NO. | CONNECTIONS SIZE & TYPE | DIMENSIONS | | Flow Capacity ¹ Tons @ 1 PSI | | | CASE QTY. |
|----------|-----------|-------------------------|------------|------|---|------------|------------|-----------|
| | | | A | B | R-134A | R-22/R410A | R404A/R507 | |
| 20106 | MLD-032 | 1/4 SAE | 4.32 | 1.63 | 2.0 | 1.9 | 1.2 | 12 |
| 20107 | MLD-032S | 1/4 ODF | 3.76 | 1.63 | 3.0 | 2.8 | 1.8 | 12 |
| 20108 | MLD-052 | 1/4 SAE | 4.88 | 2.50 | 2.1 | 2.0 | 1.3 | 12 |
| 20109 | MLD-052S | 1/4 ODF | 4.33 | 2.50 | 3.0 | 2.9 | 1.9 | 12 |
| 20111 | MLD-053S | 3/8 ODF | 4.53 | 2.50 | 6.0 | 5.8 | 3.8 | 12 |
| 20112 | MLD-082 | 1/4 SAE | 5.80 | 2.50 | 2.1 | 2.1 | 1.3 | 12 |
| 20113 | MLD-082S | 1/4 ODF | 5.24 | 2.50 | 3.1 | 3.0 | 1.9 | 12 |
| 20114 | MLD-083 | 3/8 SAE | 6.10 | 2.50 | 4.9 | 4.7 | 3.0 | 12 |
| 20115 | MLD-083S | 3/8 ODF | 5.43 | 2.50 | 6.2 | 5.9 | 3.9 | 12 |
| 20116 | MLD-162 | 1/4 SAE | 6.58 | 2.50 | 2.1 | 2.1 | 1.3 | 12 |
| 20117 | MLD-162S | 1/4 ODF | 6.02 | 2.50 | 3.1 | 3.0 | 1.9 | 12 |
| 20118 | MLD-163 | 3/8 SAE | 6.89 | 2.50 | 5.1 | 4.9 | 3.2 | 12 |
| 20119 | MLD-163S | 3/8 ODF | 6.22 | 2.50 | 6.4 | 6.2 | 4.0 | 12 |
| 20120 | MLD-164 | 1/2 SAE | 7.13 | 2.50 | 8.8 | 8.4 | 5.5 | 12 |
| 20121 | MLD-164S | 1/2 ODF | 6.27 | 2.50 | 9.2 | 8.8 | 5.7 | 12 |
| 20123 | MLD-165S | 5/8 ODF | 6.54 | 2.50 | 15.3 | 14.6 | 9.5 | 6 |
| 20125 | MLD-303S | 3/8 ODF | 8.90 | 3.00 | 7.5 | 7.2 | 4.7 | 6 |
| 20126 | MLD-304 | 1/2 SAE | 9.80 | 3.00 | 9.9 | 9.5 | 6.2 | 6 |
| 20127 | MLD-304S | 1/2 ODF | 8.94 | 3.00 | 12.3 | 11.8 | 7.7 | 6 |
| 20128 | MLD-305 | 5/8 SAE | 10.18 | 3.00 | 12.6 | 12.1 | 7.9 | 6 |
| 20129 | MLD-305S | 5/8 ODF | 9.21 | 3.00 | 16.8 | 16.1 | 10.5 | 6 |
| 20130 | MLD-306S | 3/4 ODF | 9.63 | 3.00 | 18.1 | 17.4 | 11.3 | 6 |
| 20131 | MLD-307S | 7/8 ODF | 9.80 | 3.00 | 19.0 | 18.2 | 11.8 | 6 |

¹ All ratings in accordance with ARI standard 710-04, 86°F Liquid Refrigerant Temperature, 5°F Saturated Temperature
4.0 lbs./min./ton for R-134a, 2.9 lbs./min./ton for R-22, 4.0 lbs./min./ton for R-404A/R-507



Bi-Flow Heat Pump Driers

MARS SERIES **201**

MARS Bi-Flow Heat Pump Driers

The MARS Bi-Flow Heat Pump Driers are designed to provide complete protection to the heat pump or reverse cycle system. The molded block core exposes maximum surface area for efficient filtration and retention of solid contaminants. The internal check valves prevent the release of collected contaminants when the heat pump cycles from the heating to cooling modes.

The use of molecular sieve and activated alumina in the desiccant core block provide the heat pump drier maximum moisture and acid removal. The addition of charcoal to the desiccant core allows for the removal of wax that may occur at low evaporator temperatures, giving protection to your expansion device.

Features & Benefits:

- For use on R134A, R12, R22, R500, R404A, R410A, R507
- For heat pump or reverse cycle applications
- High organic & inorganic acid removal
- Solid block desiccant core
- Proven, nylon internal check valves
- High moisture removal
- Nickel plated SAE flare and solid copper ODF fittings
- Corrosion resistant paint
- Maximum working pressure 600 PSIG
- Minimum burst pressure 2500PSIG
- UL & CSA listed

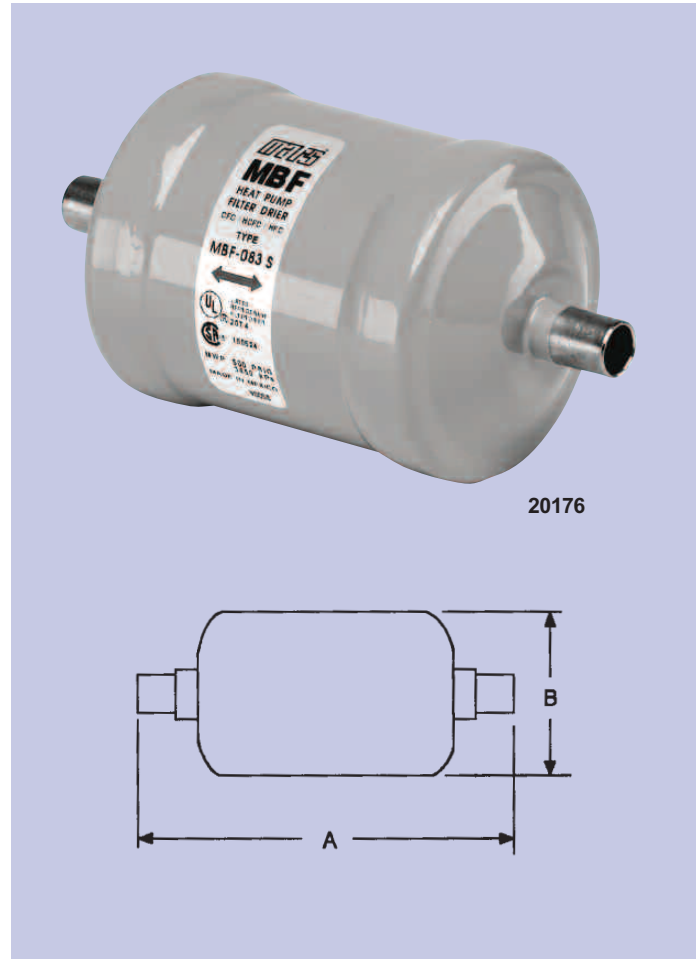

SERVICE & INSTALLATION

| MARS NO. | MODEL NO. | CONNECTIONS SIZE & TYPE | DIMENSIONS | | Flow Capacity ¹ Tons @ 1 PSI | | CASE QTY. |
|----------|-----------|-------------------------|------------|------|---|--|-----------|
| | | | A | B | R-22/R410A | | |
| 20176 | MBF-083S | 3/8 ODF | 5.63 | 2.63 | 7.4 | | 12 |
| 20178 | MBF-084S | 1/2 ODF | 5.66 | 2.63 | 9.4 | | 12 |
| 20181 | MBF-163 | 3/8 SAE | 6.97 | 3.09 | 6.7 | | 12 |
| 20182 | MBF-163S | 3/8 ODF | 6.31 | 3.09 | 7.5 | | 12 |
| 20186 | MBF-165S | 5/8 ODF | 6.63 | 3.09 | 12.4 | | 12 |

¹ All ratings in accordance with ARI standard 710-04
2.9 lbs./min./ton for R-22

Suction Line Filter Driers

MARS SERIES **201**



MARS suction line driers - flow capacities¹ in refrigerant tons at selected evaporator temps

The MARS Suction Line Filter Driers are designed to effectively clean up the refrigerant system by removing solid contaminants and harmful acids that were created during a motor burnout. As well as motor burnout applications, the MARS Suction Line Drier should be installed in remote systems with long refrigerant lines. The filter drier will collect and hold any dirt that is in the evaporator or suction line at start up. Any field built-up system requires the protection that the MARS Suction Line Drier offers.

The desiccant block core effectively removes and holds a maximum amount of contaminants with minimum pressure drop. The binding material in the core protects the core from acid decomposition and allows it to collect and hold organic and inorganic acids from motor burnout. An inlet deflector spreads the refrigerant flow evenly across the molded core to provide full filtration capacity and to prevent erosion of the core.

Features & Benefits:

- For use on R134A, R12, R22, R500, R404A, R410A, R507
- Dual access valve for accurate pressure drop readings
- Solid block desiccant core
- High organic & inorganic acid removal
- For use with HCFCs, CFCs and the lubricants that go with them
- Nickel plated SAE flare and solid copper ODF fittings
- Corrosion resistant paint
- Maximum working pressure 600 PSIG
- Minimum burst pressure 2500 PSIG
- UL & CSA listed

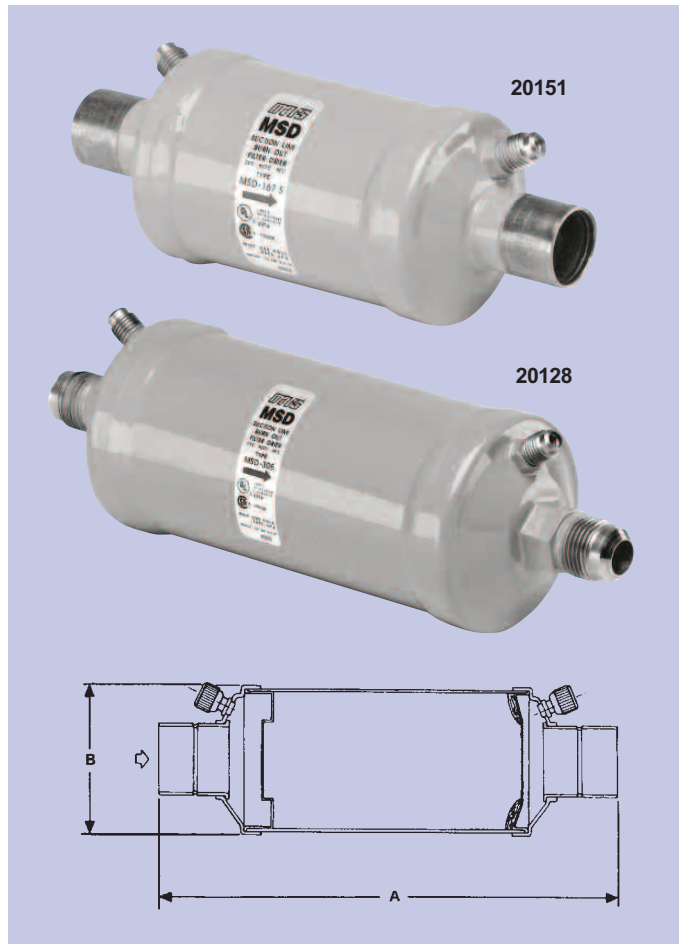

SERVICE & INSTALLATION

| MARS NO. | R-134A | | | | R-22 | | | | | R-502 | | | | | R410A Flow Capacity | | | | |
|----------|-------------------------|-----|-----|-----|-------------------------|-----|-----|-----|-----|-------------------------|-----|-----|-----|-----|-----------------------------|-----|-----|-----|-----|
| | Pressure Drop In P.S.I. | | | | Pressure Drop In P.S.I. | | | | | Pressure Drop In P.S.I. | | | | | Evaporator Temperature (F°) | | | | |
| | 2 | 1.5 | 1 | 0.5 | 3 | 2 | 1.5 | 1 | 0.5 | 3 | 2 | 1.5 | 1 | 0.5 | 3 | 2 | 1.5 | 1 | 0.5 |
| 20141 | 0.8 | 0.5 | 0.3 | 0.2 | 1.3 | 0.8 | 0.6 | 0.4 | 0.2 | 1.0 | 0.7 | 0.5 | 0.3 | 0.1 | 1.7 | 1.1 | 0.8 | 0.5 | 0.3 |
| 20143 | 1.7 | 1.2 | 0.7 | 0.4 | 2.7 | 1.8 | 1.2 | 0.8 | 0.4 | 2.2 | 1.4 | 1.0 | 0.6 | 0.3 | 2.8 | 1.9 | 1.3 | 0.8 | 0.5 |
| 20145 | 2.4 | 1.6 | 1.0 | 0.5 | 3.8 | 2.5 | 1.7 | 1.1 | 0.6 | 3.1 | 2.0 | 1.3 | 0.8 | 0.4 | 3.9 | 2.6 | 1.7 | 1.1 | 0.6 |
| 20149 | 2.2 | 1.5 | 0.9 | 0.5 | 3.4 | 2.2 | 1.5 | 1.0 | 0.5 | 2.8 | 1.8 | 1.2 | 0.8 | 0.4 | 3.5 | 2.2 | 1.5 | 1.0 | 0.5 |
| 20150 | 2.6 | 1.8 | 1.1 | 0.6 | 4.1 | 2.7 | 1.8 | 1.2 | 0.6 | 3.4 | 2.2 | 1.5 | 0.9 | 0.5 | 4.2 | 2.8 | 1.8 | 1.2 | 0.6 |
| 20151 | 2.7 | 1.8 | 1.1 | 0.6 | 4.6 | 2.8 | 1.9 | 1.1 | 0.6 | 4.3 | 2.6 | 1.7 | 1.0 | 0.6 | 4.2 | 2.8 | 1.8 | 1.2 | 0.6 |
| 20154 | 3.4 | 2.3 | 1.4 | 0.7 | 5.4 | 3.5 | 2.4 | 1.5 | 0.8 | 4.4 | 2.8 | 1.9 | 1.2 | 0.6 | 5.5 | 3.6 | 2.4 | 1.5 | 0.8 |
| 20155 | 3.8 | 2.5 | 1.6 | 0.8 | 5.9 | 3.9 | 2.6 | 1.7 | 0.9 | 4.9 | 3.1 | 2.1 | 1.3 | 0.7 | 6.0 | 4.0 | 2.6 | 1.7 | 0.9 |
| 20156 | 3.9 | 2.6 | 1.6 | 0.8 | 6.1 | 4.0 | 2.7 | 1.7 | 0.9 | 5.0 | 3.2 | 2.2 | 1.3 | 0.7 | 6.2 | 4.1 | 2.8 | 1.7 | 0.9 |

Flow Capacity In Tons Refrigerant¹ (For kW, Multiply Tons By 3.5)

¹ All ratings in accordance with ARI standard 730-04

² Example: 1.0 tons x 3.5 = 3.5 KW

| MARS NO. | MODEL NO. | SIZE & TYPE | DIMENSION | |
|----------|-----------|-------------|-----------|-----|
| | | | A | B |
| 20141 | MSD-83S | 3/8 ODF | 5.43 | 2.5 |
| 20143 | MSD-84S | 1/2 ODF | 5.48 | 2.5 |
| 20145 | MSD-85S | 5/8 ODF | 5.74 | 2.5 |

| MARS NO. | MODEL NO. | SIZE & TYPE | DIMENSION | |
|----------|-----------|-------------|-----------|-----|
| | | | A | B |
| 20149 | MSD-165S | 5/8 ODF | 6.54 | 2.5 |
| 20150 | MSD-166S | 3/4 ODF | 6.95 | 2.5 |
| 20151 | MSD-167S | 7/8 ODF | 7.13 | 2.5 |

| MARS NO. | MODEL NO. | SIZE & TYPE | DIMENSION | |
|----------|-----------|-------------|-----------|-----|
| | | | A | B |
| 20154 | MSD-306S | 3/4 ODF | 9.63 | 3.0 |
| 20155 | MSD-307S | 7/8 ODF | 9.80 | 3.0 |
| 20156 | MSD-309S | 1-1/8 ODF | 9.80 | 3.0 |



Compact Suction Line Driers

MARS SERIES **201**

MARS compact suction line driers - flow capacities in refrigerant tons at selected evaporator temperatures

The MARS compact suction line driers are designed for use in air conditioning, heat pump, and refrigeration systems in which the available space in the suction line is limited. This is especially useful in heat pump systems where the drier must be placed between the reversing valve and the compressor. This compact suction drier should be used for motor burnout clean-up applications, and installed in remote systems with long refrigerant lines. The filter drier will collect and hold any dirt that is in the evaporator or suction line at start up.

The molded desiccant core block effectively removes and holds a maximum amount of contaminants with a minimum pressure drop. The binding material in the core protects the core from acid decomposition and allows it to collect and hold organic acids from a motor burnout. An inlet deflector, spreads the refrigerant flow evenly to prevent erosion and effectively uses the full filtration capacity of the filtering system.

Features & Benefits:

- For use on R134A, R12, R22, R500, R404A, R507, R502
- High organic & inorganic acid removal
- Dual access valves for accurate pressure drop readings
- Solid block desiccant core
- For use with HCFCs, CFCs and the lubricants that go with them
- Solid copper ODF fittings
- Corrosion resistant paint
- Maximum working pressure 302 PSIG
- Minimum burst pressure 1510 PSIG

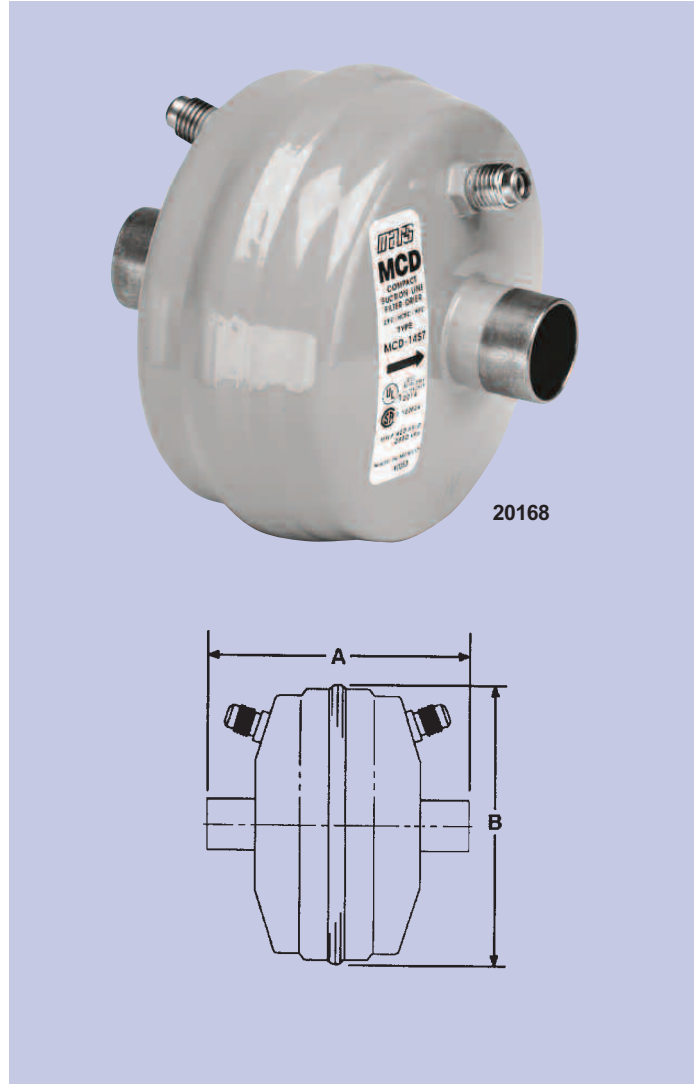

SERVICE & INSTALLATION

| MARS NO. | MODEL NO. | SIZE & TYPE | DIMENSION | | +40°F | +20°F | 0°F | -20°F | +40°F | +20°F | 0°F | -20°F | -40°F | +40°F | +20°F | 0°F | -20°F | -40°F |
|----------|-----------|-------------|-----------|------|-------------------------|-------|-----|-------|-------------------------|-------|-----|-------|-------------------------|-------|-------|-----|-------|-------|
| | | | | | R-134A | | | | R-22 | | | | R-502 | | | | | |
| | | | | | Pressure Drop In P.S.I. | | | | Pressure Drop In P.S.I. | | | | Pressure Drop In P.S.I. | | | | | |
| A | B | 2 | 1.5 | 1 | 0.5 | 3 | 2 | 1.5 | 1 | 0.5 | 3 | 2 | 1.5 | 1 | 0.5 | | | |
| 20167 | MCD-14S6 | 3/4 ODF | 4.37 | 4.57 | 3.1 | 2.1 | 1.3 | 0.7 | 4.9 | 3.2 | 2.2 | 1.4 | 0.7 | 3.6 | 2.3 | 1.5 | 0.9 | 0.5 |
| 20168 | MCD-14S7 | 7/8 ODF | 4.55 | 4.57 | 3.3 | 2.2 | 1.4 | 0.7 | 5.2 | 3.4 | 2.3 | 1.5 | 0.8 | 3.6 | 2.3 | 1.5 | 0.9 | 0.5 |

Replacement Cores

MARS SERIES **201**



MARS Interchangeable Replacement Core

The MARS replaceable cores are molded using selected desiccant materials for high acid, moisture and wax removal capabilities. They are molded for high mechanical strength using the same process used in our sealed liquid and suction line driers. The cores are fully activated and sealed in individual foil packages. The core is then packaged with a set of replacement gaskets that include a flange gasket, core gasket and a gasket for other manufacturer's shells.

The Burnout Core is for wax removal in low temperature R22 and R404A/R507 systems and for cleanup in all types of systems where motor burnout has occurred.



20193

| MARS NO. | MODEL NO. | Core Type | Dimension | | Water Capacity ¹ at 75°F | | | Water Capacity ¹ at 125°F | | |
|----------|-----------|-----------|-----------|------|-------------------------------------|------|------|--------------------------------------|------|------|
| | | | A | B | R-134A | R-22 | R502 | R-134A | R-22 | R502 |
| 20193 | MBRC-48 | Burnout | 3.66 | 5.50 | 345 | 345 | 400 | 224 | 224 | 277 |

¹R-134A = drops @ 60 ppm, R-22 = drops @ 60 ppm, R-502 = drops @ 30 ppm

SERVICE & INSTALLATION

Moisture Indicator Sight Glass

MARS SERIES **656**



MARS Sight Glass - Moisture Indicators

The MARS Moisture Indicators are constructed of forged brass bodies with brass fittings. The large viewing area of the sight glass allows for quick and easy inspection of the refrigerant as it flows through the system. Bubbles passing through the sight glass may be an indication of a low system charge or a restriction in the refrigerant system.

The moisture Indicators are designed to provide an accurate method of determining when the moisture content is dangerously wet in a refrigerant system and when the liquid line drier is no longer effective. An indicator element is highly sensitive to moisture and will gradually change color in reaction to the moisture content of the refrigerant system. Maximum working pressure is 500 PSIG. Minimum Burst pressure is 2500PSIG. UL and CSA listed.

| MARS NO | MARS MODEL NO. | DESCRIPTION | LENGTH x HEIGHT INCHES | CASE QTY. |
|---------|----------------|-------------------------|------------------------|-----------|
| 65634 | MSG-2FM | 1/4 Female x Male Flare | 2.56 x 1.29 | 12 |
| 65635 | MSG-3FM | 3/8 Female x Male Flare | 2.97 x 1.38 | 12 |
| 65636 | MSG-4FM | 1/2 Female x Male Flare | 3.99 x 1.66 | 12 |
| 65638 | MSG-2SS | 1/4 Solder x Solder | 4.57 x 1.11 | 12 |
| 65639 | MSG-3SS | 3/8 Solder x Solder | 4.69 x 1.11 | 12 |
| 65640 | MSG-4SS | 1/2 Solder x Solder | 4.88 x 1.29 | 12 |
| 65641 | MSG-5SS | 5/8 Solder x Solder | 4.88 x 1.38 | 12 |
| 65642 | MSG-7SS | 7/8 Solder x Solder | 5.90 x 1.66 | 12 |





Thermo Expansion Valves

MARS SERIES **201**

MARS Thermo Expansion Valves

The MARS Thermo Expansion Valves are used for heat pump, air conditioning, food service and commercial applications. These valves incorporate a high stability charge designed for R-22 HVAC applications. The wide range charge provides greater superheat stability, allowing two valves to cover a wide range of capabilities from 1 to 5 tons. These thermo expansion valves allow the wholesaler to consolidate inventory by replacing several valves with the two wide range valves we offer.

Features & Benefits:

- Hermetic construction eliminates external leakage
- Compact size allows installation in limited spaces
- External equalizer
- Stainless steel power element eliminates corrosion and prevents valve failure
- Integral check valve
- Maximum working pressure 600 PSIG
- Designed for R-22 applications

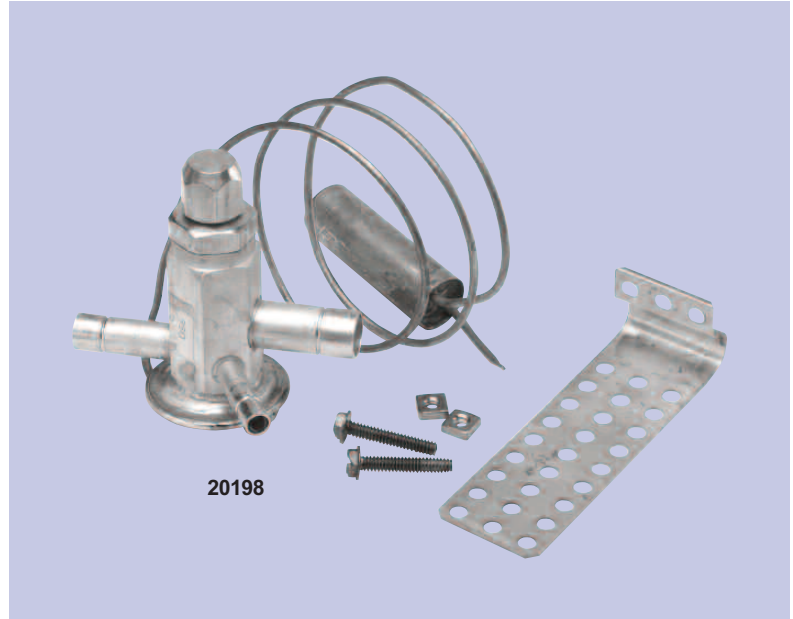

20198

| MARS NO. | MODEL NO. | CAPACITY | R-22 CAPACITY RANGE | CONNECTIONS | CAP. TUBE | CASE QTY. |
|----------|-----------|-----------|---------------------|-------------------|-----------|-----------|
| 20198 | MXV2-1/2 | 2-1/2 Ton | 1 – 3 Tons | 3/8 x 1/2 ODF S/T | 30" | 12 |
| 20199 | MXV5 | 5 Ton | 1 – 5 Tons | 3/8 x 1/2 ODF S/T | 30" | 12 |

SERVICE & INSTALLATION



Spun Copper Driers

MARS SERIES **201**

MARS Spun Copper Driers

The MARS Spun Copper Liquid Line Filter Driers are recommended for use in original equipment or replacement residential, air-conditioning or refrigeration equipment. These driers feature 100% molecular sieve for a high capacity of water retention. They provide 100 micron filtration. MARS Spun Copper driers are to be used with R-134A blends and systems with conventional refrigerants.



20101

| MARS NO. | MODEL NO. | DESCRIPTION | CONNECTIONS | | CAPACITY TONS R-134A | CAPACITY DESICCANT R-22 | LENGTH in GRAMS | OUTER in INCHES | DIAMETER |
|----------|-----------|-------------|-------------|--------|----------------------|-------------------------|-----------------|-----------------|----------|
| | | | INLET | OUTLET | | | | | |
| 20101 | MSCD-80 | Std. Duty | 1/4 | CAP | 1/3 | 1/2 | 10 | 9-5/8 | 5/8 |



The largest selection of motors, components and accessories for the HVAC/R Industry

SI-63

Spun Copper Driers

MARS SERIES **201**



MARS Spun Drier Capacity Table

Features:

- Recommended for use on original equipment, residential and commercial refrigerators, freezers and air conditioners
- XH-9 beaded molecular sieve for maximum water capacity in HFC refrigerants
- High quality – high capacity
- Hermetically sealed
- Easy break off grooved ends
- Copper shells and end tubes
- Compatible with R134

| MARS NO | DESCRIPTION | DROPS OF WATER REMOVED | | | | RECOMMENDED TONNAGE | |
|---------|-----------------|------------------------|------|------|------|---------------------|------|
| | | R-12 | | R-22 | | R-12 | R-22 |
| | | 75° | 125° | 75° | 125° | | |
| 20203 | Plugged Ends | 37.5 | 34 | 34 | 32 | 1/3 | 1/2 |
| 20303 | Plugged Ends | 37.5 | 34 | 34 | 32 | 1/3 | 1/2 |
| 20209 | Non-Directional | 37.5 | 34 | 34 | 32 | 1/3 | 1/2 |
| 20210 | Fused Ends | 37.5 | 34 | 34 | 32 | 1/3 | 1/2 |
| 20310 | Fused Ends | 37.5 | 34 | 34 | 32 | 1/3 | 1/2 |
| 20211 | Charging Drier | 74 | 38 | 68 | 64 | 3/4 | 1 |
| 20311 | Charging Drier | 74 | 38 | 68 | 64 | 3/4 | 1 |
| 20212 | Step Down Drier | 99 | 93 | 95 | 90 | 1 | 2 |
| 20213 | Double Inlet | 74 | 68 | 68 | 64 | 3/4 | 1 |
| 20214 | Fused Ends | 74 | 68 | 68 | 64 | 3/4 | 1 |
| 20215 | Charging Drier | 37.5 | 34 | 34 | 32 | 1/3 | 1 |
| 20216 | Step Down Drier | 74 | 68 | 68 | 64 | 3/4 | 1 |

MARS Spun Copper Driers

| MARS NO | DESCRIPTION | INLET | OUTLET | LENGTH | DIA. | MARS PACK |
|---------|-----------------|--------------------------|------------------|---------|------|-----------|
| 20203 | Plugged Ends | 1/4" OD | 1/4" OD | 7-3/4" | 1" | 1 |
| 20303 | Plugged Ends | 1/4" OD | 1/4" OD | 7-3/4" | 1" | 50 |
| 20209 | Non-Directional | 1/4" OD | 1/4" OD | 8-1/2" | 3/4" | 1 |
| 20210 | Fused Ends | 1/4" OD | 1/4" OD | 8-3/4" | 3/4" | 1 |
| 20310 | Fused Ends | 1/4" OD | 1/4" OD | 8-3/4" | 3/4" | 50 |
| 20211 | Charging Drier | 1/4" OD 1/4" Flare | 1/4" OD or Cap. | 8-3/4" | 1" | 1 |
| 20311 | Charging Drier | 1/4" OD 1/4" Flare | 1/4" OD or Cap. | 8-3/4" | 1" | 50 |
| 20212 | Step Down Drier | 5/16"OD | 5/16" OD or Cap. | 10-3/4" | 1" | 1 |
| 20213 | Double Inlet | (2) 1/4" OD | 1/4" OD | 8-3/4" | 1" | 1 |
| 20214 | Fused Ends | 1/4" ID 1/4" OD | 1/4" OD or Cap. | 9" | 1" | 1 |
| 20215 | Charging Drier | 1/4" ID 1/4"OD 1/4"Flare | 1/4" OD or Cap. | 9" | 3/4" | 1 |
| 20216 | Step Down Drier | 3/16, 1/4, 5/16" ID | 5/16" ID or Cap. | 8-3/4" | 1" | 1 |

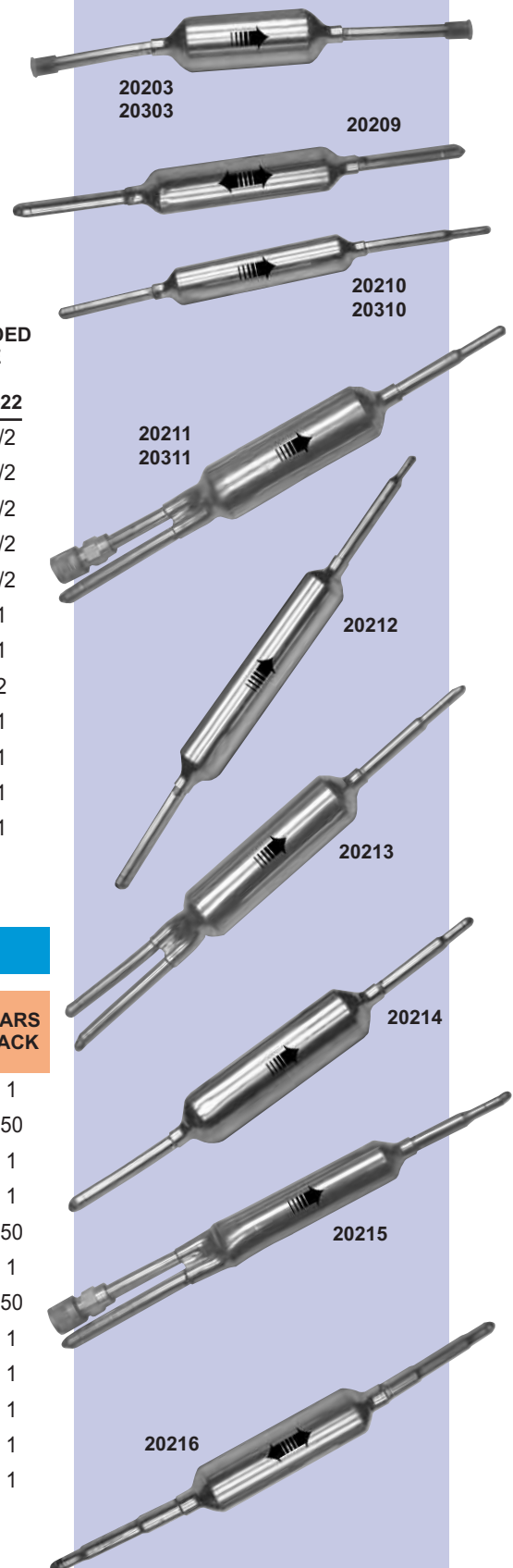



Tubing Tools

MARS SERIES **650**

Tubing Cutters And Accessories

Imperial Eastman offers a quality line of tube working tools, well recognized as standards of excellence in the HVACR industry. All tubing tools are made in the U.S.A. and come with a limited lifetime warranty.

Imperial tube cutters can be used on hard or soft copper, aluminum, brass, thin wall steel, stainless steel, monel, titanium and other metal tubing. The Hi-Duty® tube cutters (MARS #65001 and #65002) feature rollers with flare cut-off groove, fold away reamer and a spare cutting wheel. MARS #65003 is a combination tube constrictor and cutter. This combo cutter is used for brazed or sweat type connections. A roller is used in place of cutter wheel.

MARS #65004, Imp® tube cutter, requires only 1 1/4" swing radius and a 1 3/8" swing radius with 5/8" tube. This tube cutter features rollers on the bottom of the tool which allows for easier cutter engagement on tubing. The enclosed feed design minimizes contamination, assuring continued free operation. MARS #65005 requires only 1 11/16" swing radius.

The Big-Imp™ tube cutter, MARS #65006, requires only 1 15/16" swing radius and a 2 1/4" swing radius with 1 1/8" tube.

| MARS NO. | MFG. NO. | DESCRIPTION | CASE QTY. |
|----------|----------|--|-----------|
| 65001 | TC1000 | Hi-Duty® 1/8" to 1 1/8" OD | 20 |
| 65002 | 312FC | Hi-Duty® 1/4" to 1 5/8" OD | 10 |
| 65003 | TC1020 | Hi-Duty® combo 1/8" to 1 1/8" OD | 10 |
| 65004 | TC1050 | Imp® cutter 1/8" to 5/8" OD | 20 |
| 65005 | TC2050 | Imp® cutter 3/16" to 7/8" OD | 10 |
| 65006 | 174F | Big Imp™ 3/8" to 1 1/8" OD | 10 |
| 65008 | S75015 | Standard cutter wheel (10 pk) for use on #65001, 65002, 65003, 65006 | 10 |
| 65009 | S75046 | Cutter wheel for stainless steel and hard temper tubing (5 pk) for use on #65001, 65002, 65003, 65006 | 10 |
| 65010 | S74762 | Screws for cutter wheel (5 pk) for use on #65008, 65009 | 10 |
| 65011 | TC1A | Cutter wheel service kit includes: 3 standard cutter wheels 1 screw for cutter wheel | 10 |
| 65012 | TC1B | Cutter wheel stainless service kit includes: 3 cutter wheels for stainless steel and hard temper tubing 1 screw for cutter wheel | 10 |
| 65013 | TC1C | Cutter wheel service kit includes: 2 cutter wheels for #65004 1 screw for cutter wheel | 10 |
| 65014 | 206FB | Adj.-O-Matic® 1/8" - 2-5/8" OD | 1 |
| 65072 | S74761 | Cutter wheel 5 pak for use on 65014 | 1 |
| 65076 | S77511 | Screw for cutter wheel for #65072 | 1 |
| 65056 | S32633 | Cutter wheel 5 pk. on 65004, 65015 | 1 |
| 65073 | S26883 | Screw for cutter wheel for 65056 | 1 |
| 65088 | 406FA | Hi Duty Adj-O-Matic® 2" - 4-1/8" OD | 1 |
| 65074 | S74833 | Cutter wheel for 65088 | 1 |
| 65075 | S74834 | Screw for cutter wheel for #65074 | 1 |



SERVICE & INSTALLATION



The largest selection of motors, components and accessories for the HVAC/R Industry

Tubing Tools

MARS SERIES **650 & 256**



Tube Benders

Imperial lever type tube benders are used for soft copper, aluminum, brass, steel and other metal tubing. Each tool bends one size. The open size design slips over tube at any point. Our tube benders make smooth short radius bends up to 180°. Each bender tool is calibrated to show angle of bend. The wide hook grips tubing securely and the new fixed hook has easy 90° start. Our line of lever tube benders feature a swivel handle which may be repositioned to regain leverage for bends greater than 90°, eliminating bender twisting and handle crossing. The enclosed swivel mechanism provides extended life. Ideal for bending stainless steel, as well as other tubing.

Imperial Imp® triple header benders feature calibrated markings for accurate left-hand, right-hand and offset bends. 90° start requires less effort - making bending fast and easy.

Imperial spring type tube benders are for use on soft copper and aluminum tubing. These tools allow hand bending of soft tubing to any shape without collapsing walls. Special spring steel, nickel finished. End belled for quick tube removal.

| MARS NO. | MFG. NO. | DESCRIPTION | CASE QTY. |
|----------|----------|--|-----------|
| 65018 | 364FHA06 | Lever type 3/8" OD | 10 |
| 65063 | 364FHA10 | Lever type 5/8" OD | 10 |
| 65021* | 364FHB06 | Lever type with swivel handle 3/8" OD | 5 |
| 65022* | 364FHB08 | Lever type with swivel handle 1/2" OD | 5 |
| 65024 | 368FH | Triple header; 1/4", 5/16", 3/8" OD 15/16" radius to center | 10 |
| 65025 | 102F04 | Spring type 1/4" OD | 10 |
| 65026 | 102F06 | Spring type 3/8" OD | 10 |
| 65028 | 102F08 | Spring type 1/2" OD | 10 |
| 65031 | 102F10 | Spring type 5/8" OD | 10 |
| 65032 | 102F12 | Spring type 3/4" OD | 10 |
| 65033 | 102F14 | Spring type 7/8" OD | 10 |
| 65029 | 163F | Spring set; 1/4", 3/8", 1/2", 5/8" OD | 10 |

*patented

MARS Tube Benders

| MARS NO. | DESCRIPTION | MARS PACK | CASE QTY. |
|----------|---|-----------|-----------|
| 25660 | External spring type tube benders, 1/4", 3/8", 1/2" & 5/8", set of 4 | 1 | 24 |

Tubing Tool Kits

MARS #65059, 45° flaring and swaging tool kit is for use on 1/8", 3/16", 1/4", 5/16", 3/8", 7/16", 1/2" and 3/4" OD tubing. Flares or swages. Converts quickly. Features screw-type feed. Ideal close quarters tool. Swivel type swaging adapters and spreader cone are hard-chrome finished for easy operation. Self centering, slip-on forged steel yoke. Includes five swage adapters for 3/16", 1/4", 5/16", 3/8", 1/2" and 3/4" OD tubing. Packaged in a plastic kit.

MARS #65034, 45° flaring kit is for use on 1/8" - 3/4" OD tubing. This compact kit contains two flaring bars & one yoke. The self centering forged steel yoke has a slip-on feature. The swivel flaring cone reduces effort. Packaged in plastic case.

| MARS NO. | MFG. NO. | DESCRIPTION | CASE QTY. |
|----------|----------|---------------------------------|-----------|
| 65059 | 275FS | 45° flaring and swaging tool | 1 |
| 65034 | 375FS | 45° flaring kit for 1/8" - 3/4" | 1 |

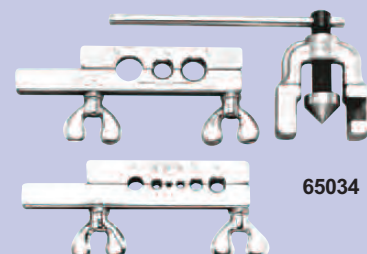
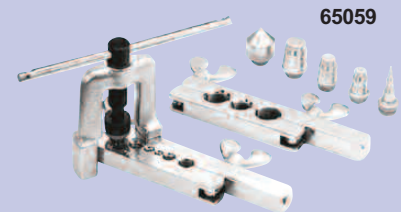
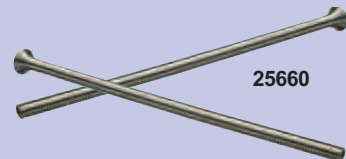
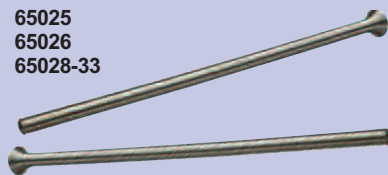
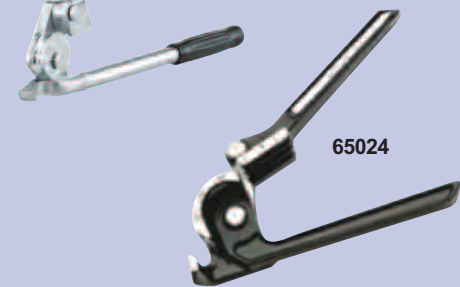



Flaring Tools

Imperial MARS #65035, Rol-Air® flaring tool, is used for soft copper, aluminum and brass. This flaring tool flares and burnishes 3/16", 1/4", 5/16", 3/8", 1/2" and 5/8" OD tubing. The faceted, hard chrome finished cone rolls out perfect 37° flares above die block - then automatically burnishes flare face. Original wall thickness is maintained at base of flare. Slip-on yoke permits use in tight quarters. The heat treated dies grip tubing without scoring.

MARS #65036, 37° flaring tool, is for use on copper, aluminum, steel, stainless steel and other metal tubing. Three rollers in flaring cone roll out a 37° flare above die block. There is an extension on the yoke for clamping in vise. This flaring tool is for 3/16", 1/4", 5/16", 3/8", 1/2" and 5/8" OD tubing and is furnished in a plastic kit.

Imperial's 45° flaring tool, MARS #65037, is for 3/16", 1/4", 5/16", 3/8", 7/16", 1/2" and 5/8" OD tubing. This tool features a self-centering yoke with swivel-type, hard chrome finished flaring cone to form better flares with less effort. The yoke is designed to permit flaring where there is little space between nut and tube end. This flaring tool is for use on soft copper, aluminum and brass tubing.

The 45° Rol-Air® flaring tool, MARS #65038, is used for flaring and burnishing 3/16", 1/4", 5/16", 3/8", 1/2" and 5/8" OD tubing. The flares are rolled out above die bar by a super-smooth faceted cone. Automatically burnishes flare face. The slip-on yoke permits use in tight quarters. Heat treated dies grip tubing without scoring. For use on soft copper, aluminum and brass tubing.

Imperial's Grabber™ Rol-Air® flaring tool flares and burnishes 3/16" to 5/8" OD tubing. This 45° flaring tool is for use on soft copper, aluminum and brass tubing. MARS #65039 features a unique, self-adjusted, tube holding mechanism which permits use in tight quarters. The faceted, hard chrome finished cone rolls out and burnishes a perfect 45° flare above the tube holding mechanism.

| MARS NO. | MFG. NO. | DESCRIPTION | CASE QTY. |
|----------|----------|--|-----------|
| 65035 | 507FB | Rol-Air® 37° for 3/16" to 5/8" OD | 1 |
| 65037 | 195FC | 45° for 3/16" to 5/8" OD | 10 |
| 65038 | 500FC | Rol-Air® 45° for 3/16" to 5/8" OD | 10 |
| 65039 | 525F | Grabber™ Rol-Air® 45° for 3/16" to 5/8" OD | 10 |
| 65046 | 103FS | 45° for 3/4", 7/8", 1" OD | 1 |
| 65047 | 203FA | 45° for 5/8" to 1-1/8" OD | 1 |
| 65048 | 296FC | 45° for 3/16" to 5/8" OD | 1 |
| 65049 | 300FB | Hi Duty 45° for 3/16" to 5/8" OD | 1 |

Pinch Off Tool

Pinch-off tool temporarily closes soft copper, aluminum or steel tubing so no liquid or gas passes. Lets you disconnect line while making repairs without loss of liquid or gas. Also opens tubing and rounds it back into shape. For use on 1/4", 3/8" and 1/2" OD tubing.

| MARS NO. | MFG. NO. | DESCRIPTION | CASE QTY. |
|----------|----------|--------------------------------|-----------|
| 65050 | 105FF | Pinch off tool (copper tubing) | 1 |



Tubing Tools

MARS SERIES **650 & 790**



Reamers, Swaging Tools, Wrenches & Tube Adapters

Imperial inner/outer reamers and deburring tools ream both inside and outside edges of tube with three hollow ground tool steel cutters. Fits comfortably in hand. MARS #65066, inner/outer reamer and deburring tool is used for copper, aluminum and brass tubing and has a blue finish.

Swaging tools are to be used on soft copper, aluminum and brass tubing. Our punch-type swaging tools make tubing connections without the use of fittings. Simply enlarge end of tube, insert another tube and solder like a sweat fitting. MARS #65069 swaging punch tool is for 1/2" OD tubing. The swaging punch kit, MARS #65070, contains four swaging punches - 1/4", 3/8", 1/2" and 5/8" OD. Packaged in vinyl case.

Imperial's tube adapter is used for charging and testing. To connect a hermetic system, pinch-off tube is cut off and adapter is slipped over cut end of tube and tightened. Synthetic rubber seal of adapter grips outside of tube. This gives a 1/4" male flare connection to system for purging, charging or testing. After system is recharged, tube is pinched off next to adapter. Adapter is then removed and tube is cut off and sealed with solder. Adapter can be used repeatedly.

MARS #65082 is a combination wrench with the four sizes most needed for servicing air conditioning units. MARS #65083 is for use on compressors with access valves in hard to reach places. This reversible ratchet is chrome plated.

| MARS NO. | MFG. NO. | DESCRIPTION | CASE QTY. |
|----------|----------|--|-----------|
| 65066 | 208F | Inner/outer reamer and deburring tool | 10 |
| 65069 | 94S | 1/2", 5/8", 7/8" OD swaging punch tool | 1 |
| 65070 | 193S | swaging punch kit | 20 |
| 65085 | 93S03 | 3/16" OD swaging punch | 20 |
| 65086 | 93S04 | 1/4" OD swaging punch | 1 |
| 65089 | 93S05 | 5/16" OD swaging punch | 1 |
| 65093 | 93S12 | 3/4" OD swaging punch | 1 |
| 65094 | 93S14 | 7/8" OD swaging punch | 1 |
| 65051 | 241F04 | Tube adapter 1/4" O.D. | 1 |
| 65082 | 124C | 9/16" and 1/2" hex; 3/16" & 1/4" sq. ratchet | 1 |
| 65083 | 127C | 1/4", 3/8", 3/16", 5/16" square ratchet | 1 |

SURE CUT Ratchet Tubing Cutter

- Cuts copper, brass, aluminum tubing and thin-wall conduit
- Ratchets for fast, easy cuts in tight areas
- Self feeding action for automatic cutting
- Strong, lightweight nylon & fiberglass handle
- Spare cutting wheel is supplied in the handle

| MARS NO. | DESCRIPTION | MARS PACK | CASE QTY. |
|----------|--------------------|-----------|-----------|
| 65201 | 5/16" to 1 1/8" OD | 1 | 12 |
| 65202 | 1/4" to 7/8" OD | 1 | 12 |
| 65203 | Replacement Blades | 1 | 12 |

EASY BEND Ratcheting Tubing Bender

- For bending OD tubing sizes from 3/8" to 7/8"
- Use on soft copper, coated soft copper, thin wall hydraulic tubing and plastic coated aluminum composite pipe
- Kit includes impact resistant carry case, tubing cutter and ID/OD reamer
- Single-hand manual ratchet operation

| MARS NO. | DESCRIPTION | MARS PACK | CASE QTY. |
|----------|---------------|-----------|-----------|
| 65210 | Tubing Bender | 1 | 3 |

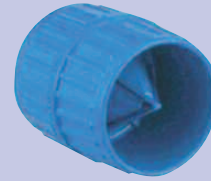

65066



65070



65069



65051



65082



65083

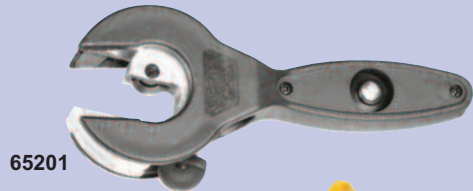

65201



65210

Service Manifolds & Accessories

MARS SERIES **651**



Service Manifolds

Imperial and Motors & Armatures, Inc., offer refrigeration and air conditioning service manifolds. The Man Handler™ 4-valve manifolds feature up to four times faster system evacuation. The 4 valve efficiency provides vacuum, low side, high side and refrigerant lines individually connected and controlled. No need to switch charging lines. T-grip controls offer non-slip operation. Other features include swivel hanger, brass hose end closure bracket and a deep, vacuum valve design. The red and blue gauges are calibrated in psi. MARS #65101 is a standard 4 valve manifold and MARS #65102 is a 4 valve manifold with four 60" std. fitting charging lines (one 3/8" line, three 1/4" lines). MARS #65103 is a 4 valve manifold with sight glass. For R-12, R-22 and R-502 refrigerants.

Imperial's convertible 2 valve brass manifolds feature non-flutter gauges, tough gauge crystals, swivel hanger, brass hose end closure spuds, soft-seat valves and color coded controls. The red and blue gauges are calibrated in psi. MARS #65104 is the standard 2 valve manifold. MARS #65105 is the 2 valve manifold with three 36" std. fitting charging lines. For R-12, R-22 and R-502 refrigerants.

| MARS NO. | MFG. NO. | DESCRIPTION | CASE QTY. |
|--------------------|----------|-------------------------------------|-----------|
| 65101 ¹ | 620C | 4 valve manifold | 20 |
| 65102 ¹ | 621C | 4 valve manifold with (4) 60" hoses | 20 |
| 65103 ¹ | 620CS | 4 valve manifold with sight glass | 1 |
| 65104 | 495C | 2 valve manifold | 30 |
| 65105 | 496C | 2 valve manifold with (3) 36" hoses | 30 |
| 65108 | 400RL | Low side repair kit for 2 valve | 1 |
| 65111 | 400RH | High side repair kit for 2 valve | 1 |
| 65109 | S8922562 | Hook assembly for 4 valve | 1 |
| 65110 | S9449101 | Closure bracket plate for 4 valve | 1 |
| 65116 | 600R | Diaphragm replacement seal kit | 1 |
| 65117 | 601R | Replacement VAC & REF knobs w/stems | 1 |
| 65118 | 602R | Replacement HI & LO | 1 |

¹Patented, UL recognized for commercial refrigeration & A/C applications

Manifold Accessories

Imperial patented, UL recognized kwik-couplers are intended for use with refrigeration/air conditioning service manifold high and low side hoses, when connecting to core valve type service fittings. Simply push to connect and pull to disconnect. Valve cores are depressed automatically without adjustments or loss of refrigerant. An automatic shut off valve retains refrigerant pressure in disconnect hose.

| MARS NO. | MFG. NO. | DESCRIPTION | CASE QTY. |
|----------|----------|---|-----------|
| 65139 | 16C | Straight coupler (45° flare) 1/4"F x 1/4"M | 20 |
| 65140 | 17C | 90° elbow coupler (45° flare) 1/4"F x 1/4"M | 20 |
| 65141 | 18C | Coupler set (#16C and 17C) | 15 |
| 65151 | 535C | Kwik charge liquid low side | 1 |

65101
65102
65103



65104
65105

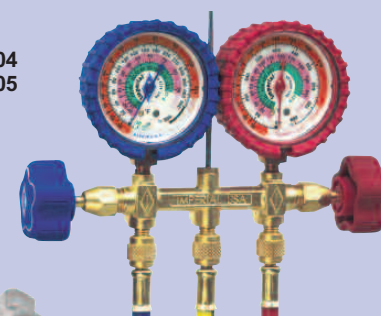

65108
65111



65139

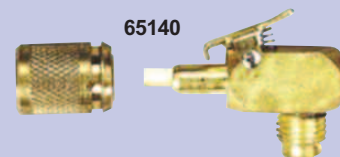

65140



65141



65151

SERVICE & INSTALLATION



The largest selection of motors, components and accessories for the HVAC/R Industry

SI-69

Vibration Absorbers

MARS SERIES **523**



Stainless Steel Vibration Absorbers

- 100% Copper connections
- Hose and copper braze welded
- Each unit dehydrated and vacuum tested
- Units individually packaged in poly bags and corrugate boxes
- UL, cUL, and CE

| MARS NO. | DESCRIPTION | MARS PACK |
|----------|---------------------------|-----------|
| 52329 | 1/4" Vibration Absorber | 1 |
| 52330 | 3/8" Vibration Absorber | 1 |
| 52331 | 1/2" Vibration Absorber | 1 |
| 52332 | 5/8" Vibration Absorber | 1 |
| 52333 | 3/4" Vibration Absorber | 1 |
| 52334 | 7/8" Vibration Absorber | 1 |
| 52335 | 1-1/8" Vibration Absorber | 1 |
| 52336 | 1-3/8" Vibration Absorber | 1 |
| 52337 | 1-5/8" Vibration Absorber | 1 |
| 52338 | 2-1/8" Vibration Absorber | 1 |
| 52339 | 2-5/8" Vibration Absorber | 1 |
| 52340 | 3-1/8" Vibration Absorber | 1 |

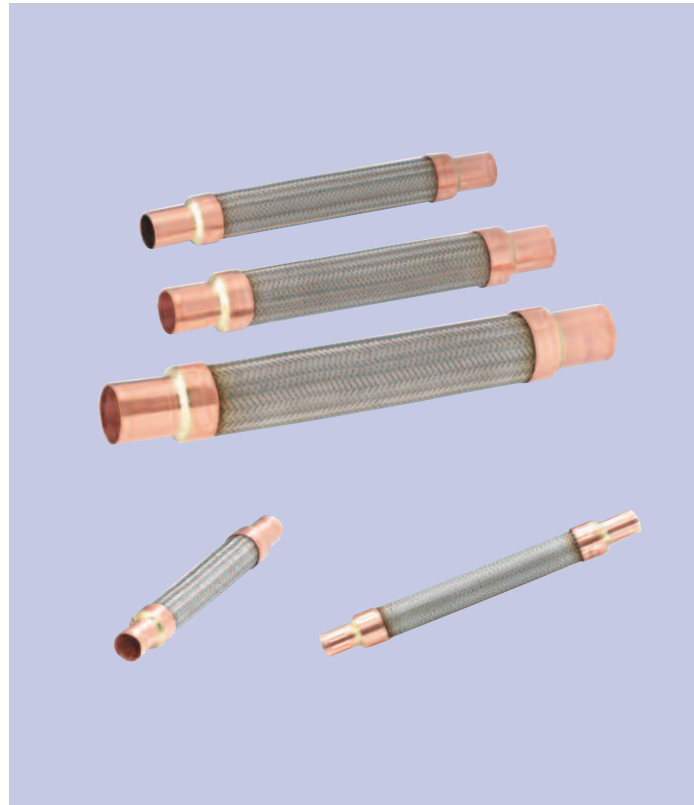



Wrot Copper Fittings

MARS SERIES **647**

9600 RS Couplings-Rolled Stop-Copper To Copper

| MARS NO. | MODEL NO. | DESCRIPTION | MARS PACK | CASE QTY. |
|----------|-----------|-------------|-----------|-----------|
| 64721 | W1001 | 3/16" O.D. | 10 | 100 |
| 64722 | W1003 | 1/4" O.D. | 100 | 1000 |
| 64720 | W10142 | 5/16" O.D. | 100 | 4000 |
| 64723 | W1009 | 3/8" O.D. | 100 | 2000 |
| 64724 | W1017 | 1/2" O.D. | 100 | 2000 |
| 64725 | W1022 | 5/8" O.D. | 100 | 1000 |
| 64726 | W1028 | 3/4" O.D. | 100 | 500 |
| 64727 | W1034 | 7/8" O.D. | 50 | 500 |
| 64728 | W1047 | 1 1/8" O.D. | 25 | 250 |
| 64729 | W1055 | 1 3/8" O.D. | 25 | 250 |

9600 Reducing Couplings - W/Stop-Copper To Copper

| MARS NO. | MODEL NO. | DESCRIPTION | MARS PACK | CASE QTY. |
|----------|-----------|--------------------|-----------|-----------|
| 64734 | W1010 | 3/8" x 5/16" O.D. | 10 | 1000 |
| 64735 | W1011 | 3/8" x 1/4" O.D. | 50 | 1000 |
| 64739 | W1025 | 5/8" x 3/8" O.D. | 10 | 2000 |
| 64740 | W1029 | 3/4" x 5/8" O.D. | 50 | 500 |
| 64741 | W1030 | 3/4" x 1/2" O.D. | 10 | 1000 |
| 64742 | W1035 | 7/8" x 3/4" O.D. | 50 | 500 |
| 64745 | W1049 | 1 1/8" x 7/8" O.D. | 25 | 250 |

9607LT 90° Elbows - Long Radius Copper To Copper

| MARS NO. | MODEL NO. | DESCRIPTION | MARS PACK | CASE QTY. |
|----------|-----------|-------------|-----------|-----------|
| 64823 | W2715 | 1/4" O.D. | 50 | 3000 |
| 64825 | W2716 | 3/8" O.D. | 50 | 2000 |
| 64826 | W2717 | 1/2" O.D. | 50 | 1000 |
| 64827 | W2722 | 5/8" O.D. | 50 | 500 |
| 64828 | W2728 | 3/4" O.D. | 50 | 500 |
| 64829 | W2734 | 7/8" O.D. | 25 | 250 |
| 64830 | W2747 | 1 1/8" O.D. | 10 | 1000 |
| 64831 | W2055 | 1 3/8" O.D. | 5 | 100 |

9607 90° Elbows-Short Radius Copper To Copper

| MARS NO. | MODEL NO. | DESCRIPTION | MARS PACK | CASE QTY. |
|----------|-----------|-------------|-----------|-----------|
| 64800 | W2003 | 1/4" O.D. | 50 | 500 |
| 64801 | W2009 | 3/8" O.D. | 50 | 2000 |
| 64802 | W2017 | 1/2" O.D. | 50 | 1000 |
| 64803* | W2022 | 5/8" O.D. | 100 | 1000 |
| 64804* | W2028 | 3/4" O.D. | 50 | 500 |
| 64805* | W2034 | 7/8" O.D. | 50 | 250 |

*intermediate radius

9607-2LT 90° Street Elbows - Long Radius

| MARS NO. | MODEL NO. | DESCRIPTION | MARS PACK | CASE QTY. |
|----------|-----------|-------------|-----------|-----------|
| 64813 | W2809 | 3/8" O.D. | 50 | 500 |
| 64814 | W2817 | 1/2" O.D. | 50 | 500 |
| 64815 | W2822 | 5/8" O.D. | 50 | 500 |
| 64816 | W2828 | 3/4" O.D. | 25 | 250 |
| 64817 | W2834 | 7/8" O.D. | 25 | 250 |
| 64818 | W2847 | 1 1/8" O.D. | 10 | 100 |
| 64819 | W2350 | 1 3/8" O.D. | 10 | 100 |

NIBCO
AHEAD OF THE FLOW™



64721-64729



64734-64745



64823-31



64800-05



64813-19

SERVICE & INSTALLATION

Brazing Alloys, Solders & Fluxes

MARS SERIES **793**



Sil-Fos Brazing Alloys - 1/8" X .05" X .20"- 1 Lb. Spool

Sil-Fos® alloys allow the joining of copper to copper without a flux and copper based alloys (brass and bronze) with a flux. Sil-Fos® is the workhorse filler metal used in the a/c and refrigeration industry. A key factor is the ductility of Sil-Fos® 15. It can be readily bent (without heating), thus permitting easier access to the backsides of joints.

The Sil-Fos® 15 is the best alloy for general copper-copper brazing in the Sil-Fos® family. The phosphorus in the Sil-Fos® product serves as the fluxing agent and no separate flux is necessary. For brass applications however, flux is recommended. For use where close fit-ups cannot be maintained Sil-Fos® 15 works well to "bridge" gaps. Sil-Fos® 15 is the most ductile of the entire Sil-Fos® family to best withstand the stresses inherent in refrigeration applications. Slow Flow.

The Sil-Fos® 6M is recommended for use where close fit-ups cannot be maintained. It has the ability to fill gaps and form fillets without affecting joint strength. Slow Flow.

The Sil-Fos® 5 is designed primarily for those applications where close fit-ups cannot be maintained. It has the ability to fill gaps and form fillets without adversely affecting joint strength. Slow Flow.

Fos-Flo® 7 is an economical, very fluid medium temperature filler metal for use with copper, brass and bronze. Withstands moderate vibration. Fast Flow.

Also available for merchandising assistance is the point of purchase display rack suitable for counter top display or hanging on pegboard. This display #78300 is available at no charge upon request with a \$1500 minimum order of Lucas brazing/solder products. Cardboard display dimensions: 25"H x 23"W x 10 1/5" deep at base x 6 1/4" deep at top (30 3/4" overall height including header).



SERVICE & INSTALLATION

| MARS NO. | AWS SPEC | COMPOSITION % | | | TEMPERATURE | | MARS PACK | CASE QTY. | |
|----------|-------------|---------------|----|------|-------------|---------|-----------------|-----------|----|
| | | Ag | Cu | P | MELT | FLOW | | | |
| 78301 | Sil-Fos® 15 | BCuP-5 | 15 | 80 | 5 | 1190° F | 1475° F (1300°) | 1 | 25 |
| 78302 | Sil-Fos® 6M | BCuP-4 | 6 | 88 | 6 | 1190° F | 1460° F (1300°) | 1 | 25 |
| 78303 | Sil-Fos® 5 | BCuP-3 | 5 | 89 | 6 | 1125° F | 1495° F (1300°) | 1 | 25 |
| 78304 | Fos-Flo® 7 | BCuP-2 | | 92.8 | 7.2 | 1310° F | 1460° F (1350°) | 1 | 25 |

Brazing Alloys, Solders & Fluxes

MARS SERIES **793**

High Silver Brazing Alloys - 1/16" Dia. Coils

In refrigeration applications, much of the brazing involves joining copper tubing. However, there are numerous applications where other materials need to be joined (steel, brass, stainless, etc.). These high silver brazing alloys facilitate the joining of these metals. The one alloy in particular which is highly recommended for virtually all above mentioned base metals is Braze® 505. It's advantages over 56% and 45% include:

- It contains 2% Nickel which enhances wetting and strength and facilitates the joining of steels, stainless steel, carbide, etc.
- It doesn't contain tin. This prevents the formation of brittle intermetallics which can cause joint failures when stresses accumulate.
- The flow characteristics can be easily manipulated by either fast or slow heating techniques - this allows bridging of gaps.
- It's available in flux-coated rod for added convenience and ease-of-use: No separate fluxing operation.

Braze® 450 is a general purpose filler metal for joining ferrous, non-ferrous and dissimilar metals with large joint clearances. Cadmium-free.

Braze® 505 is the best general purpose filler metal available. It is the only alloy recommended for stainless steel (as it retards/eliminates interface corrosion) and carbide applications. Nickel content provides superior adhesion ("wetting") to base metal surfaces. Available, and especially convenient, as flux coated rod. Cadmium-free.

Braze® 560 is the lowest temperature, Cadmium-free filler metal available. This is a good general purpose alloy for close joint tolerances.

Lucas-Milhaupt, Inc.
A Handy & Harman Company



SERVICE & INSTALLATION

| MARS NO. | AWS SPEC | COMPOSITION % | | | | | | TEMPERATURE | | MARS PACK | CASE QTY. |
|----------|--|---------------|----|----|----|-------|------|-------------|---------|-----------|-----------|
| | | Ag | Cu | Zn | Sn | Other | MELT | FLOW | | | |
| 78305 | Braze® 450 1oz | BAg-5 | 45 | 30 | 25 | | | 1225° F | 1370° F | 1 | 24 |
| 78306 | Braze® 450 3oz | | | | | | | | | 1 | 24 |
| 78307 | Braze® 450 5oz | | | | | | | | | 1 | 24 |
| 78308 | Braze® 505 1oz | BAg-24 | 50 | 20 | 28 | 2 Ni | | 1220° F | 1305° F | 1 | 24 |
| 78309 | Braze® 505 3oz | | | | | | | | | 1 | 24 |
| 78310 | Braze® 505 5oz | | | | | | | | | 1 | 24 |
| 78314 | Braze® 505 F/C, Flux coated rod, 18" stick x 1/4 lb tube | BAg-24 | 50 | 20 | 28 | 2 Ni | | 1220° F | 1305° F | 1 | 15 |

Brazing & Solder Fluxes

Where fluxing is required as part of the brazing operation, Handy Flux is recommended. Handy Flux is an all-purpose flux for use in brazing both ferrous and non-ferrous metals and alloys. Handy Flux conforms to: AWS Brazing Flux Type #3A, Federal Spec. O-F-499d (216185) Type B, Society of Automotive Engineers AMS-3410G. For soldering applications we offer two different flux products depending on the materials to be joined. They include Clean-n-Brite Flux for general purpose applications and TEC Liquid Flux where more aggressive fluxing is required for the more difficult-to-solder materials (e.g. steel, stainless steel, etc.).

| MARS NO. | DESCRIPTION | MARS PACK | CASE QTY. |
|----------|--|-----------|-----------|
| 78315 | Handy Flux - 7oz. jar w/brush cap | 1 | 24 |
| 78319 | TEC Liquid Flux - 4oz. squeeze bottle | 1 | 48 |
| 78320 | Clean-n-Brite Flux -4oz. paste w/brush | 1 | 24 |



78319



The largest selection of motors, components and accessories for the HVAC/R Industry

SI-73

Brazing Alloys, Solders & Fluxes

MARS SERIES **793**



Silver Bearing Soft Solders - 1/8" X 1 Lb. Spool

Clean-n-Brite solders are a high strength general purpose solder. They offer a higher strength than Tin/Lead solders and are safe for potable water systems. These alloys are widely used in low stress, low pressure copper-copper and copper-steel applications (e.g. sight glasses where temperature must be kept low, etc.). For copper-copper, Clean-n-Brite Paste Flux is the flux of choice. For copper-steel applications, TEC Liquid Flux is recommended as it is more aggressive at keeping the metal surfaces to be joined free of oxides. TEC is a more corrosive flux however, and subsequent flux residue removal is recommended.

Clean-n-Brite is a Lead-free, silver-bearing high-strength solder used for applications requiring close joint clearances.

Clean-n-Brite 6 is a Lead-free, silver-bearing high-strength solder used for applications requiring large joint clearances. It is the easiest Silver-bearing soft solder to work with as temperature range permits "bridging" loose fit-ups if necessary.

Clean-n-Brite No Lead is a Silver-bearing solder with good strength used in potable water system applications requiring no lead.



Lucas-Milhaupt, Inc.
A Hanay & Harman Company

SERVICE & INSTALLATION

| MARS NO. | | COMPOSITION % | | | TEMPERATURE | | MARS PACK | CASE QTY. |
|----------|-----------------------|---------------|----|------|-------------|--------|-----------|-----------|
| | | Ag | Cu | P | MELT | FLOW | | |
| 78316 | Clean-n-Brite | 3.6 | | 96.4 | 431° F | 431° F | 1 | 24 |
| 78317 | Clean-n-Brite 6 | 6 | | 94 | 431° F | 535° F | 1 | 24 |
| 78318 | Clean-n-Brite No Lead | 0.5 | 4 | 95.5 | 428° F | 446° F | 1 | 24 |

MARS Cross Reference Guide

| MARS NO. | HANDY HARMON | LUCAS MILHAUPT | J.W. HARRIS | ENGELHARD |
|----------|-------------------------|----------------|--------------------------------|----------------|
| 78301 | Sil-Fos15 | 95150 | 61035 (Stay-Silv 15) | Silvaloy 15 |
| 78302 | Sil-Fos 6M | 95120 | 66000 (Dynaflow) | Silvaloy 6 |
| 78303 | Sil-Fos 5 | 95060 | 41035 (Stay-Silv 5) | Silvaloy 5 |
| 78304 | Fos-Flo 7 | 95000 | 21035 (Stay-Silv 0) | Silvaloy 0 |
| 78305 | Braze 450 (1oz.) | 98000 | 76310 (Safety-Silv 45) | Silvaloy A-45 |
| 78306 | Braze 450 (3oz.) | 98001 | 76313 (Safety-Silv 45) | Silvaloy A-45 |
| 78307 | Braze 450 (5oz.) | 98002 | 76315 (Safety-Silv 45) | Silvaloy A-45 |
| 78308 | Braze 505 (1oz.) | 98070 | | |
| 78309 | Braze 505 (3oz.) | 98071 | | |
| 78310 | Braze 505 (5oz.) | 98072 | | |
| 78311 | Braze 560 (1oz.) | 98060 | 75310 (Safety-Silv 56) | Silvaloy A-56 |
| 78314 | Braze 505 F/C | 98110 | | |
| 78315 | Handy Flux | 97030 | 40022 (Stay-Silv Flux) | Ultra Flux |
| 78316 | Clean-n-Brite | 96000 | 10001 (Stay-Brite) | Silvabrite |
| 78317 | Clean-n-Brite 6 | 96010 | 10009 (Stay-Brite 8) | Silvabrite S |
| 78318 | Clean-n-Brite (no lead) | 96150 | 15000 (Stay-Safe 50)* | Silvabrite 100 |
| 78319 | Tec Liquid Flux | 97000 | 40002 (Stay-Clean) | 70001 |
| 78320 | Clean-n-Brite Flux | 97020 | 40027 (Stay-Clean Solder Flux) | 71003 |

* While this material does not have a chemistry exactly equivalent, it is similar in composition to Clean-n-Brite no lead and typically used in similar applications.

Soft Copper Refrigeration Coils

MARS SERIES **649**

Soft Copper Refrigeration Coils

- 50' Length
- ASTMB280
- Individually shrink wrapped rolls

| MARS NO. | SIZE | COILS/SKID | COILS/BOX |
|----------|--------|------------|-----------|
| 50014 | 1/4" | 440 | 10 |
| 50516 | 5/16" | 480 | 10 |
| 50038 | 3/8" | 416 | 8 |
| 50012 | 1/2" | 100 | 5 |
| 50058 | 5/8" | 100 | 5 |
| 50034 | 3/4" | 69 | 3 |
| 50078 | 7/8" | 60 | 3 |
| 50118 | 1-1/8" | 42 | 1 |



50014



Lines & Tubing

MARS SERIES **799**

MARS Pilot Burner Gas Lines

MARS pilot burner gas line is 6.5 ft of clean aluminum tubing with compression nuts and sleeves. Coiled and individually polybagged. 50' coils do not include fittings.

| MARS NO. | DESCRIPTION | MARS PACK |
|----------|--------------------------------|-----------|
| 79126 | 1/4" OD x 6.5' aluminum tubing | 1 |

MARS Clear Vinyl Tubing, - Boxed

| MARS NO. | DESCRIPTION | CASE QTY. |
|----------|--|-----------|
| 79131 | 1/4" ID clear tubing 32 PSI - .375 O.D. | 100 feet |
| 79132 | 3/8" ID clear tubing 27 PSI - .500 O.D. | 100 feet |
| 79133 | 1/2" ID clear tubing 24 PSI - .625 O.D. | 100 feet |
| 79134 | 5/8" ID clear tubing 21 PSI - .750 O.D. | 100 feet |
| 79135 | 3/4" ID clear tubing 19 PSI - .890 O.D. | 100 feet |
| 79136 | 7/8" ID clear tubing 16 PSI - 1.015 O.D. | 50 feet |

MARS Polyethylene Tubing, FDA Approved

| MARS NO. | DESCRIPTION | CASE QTY. |
|----------|---|-----------|
| 79137 | 1/4" OD clear tubing boxed 135 PSI @ room temp. | 100 feet |

MARS Humidifier/Icemaker Kit

The MARS humidifier/icemaker tubing kit includes 25' of FDA approved, 1/4" OD, non-toxic polyethylene tubing. Self tapping saddle valve and compression fittings also included. Polybagged.

| MARS NO. | DESCRIPTION | CASE QTY. |
|----------|-------------------------|-----------|
| 79129 | Humidifier/icemaker kit | 36 |
| 79139 | MARS saddle valve | 1 |



79126

79131-36

79137

79139



The largest selection of motors, components and accessories for the HVAC/R Industry

SI-75

SERVICE & INSTALLATION

Specialty Tools

MARS SERIES **790**



Specialty Tools

The MARS telescoping pilot match holder with magnet collapses to fit in shirt pocket. Extends to 25". Attractively packaged and barcoded for merchandising.

| MARS NO. | DESCRIPTION | MARS PACK |
|----------|--------------------|-----------|
| 79130 | Pilot match holder | 1 |

Inspection Mirrors

MARS offers inspection mirrors for virtually any application! Telescoping types available, along with round glass, oval glass, rectangular glass, round metal and rectangular metal. Attractively carded and barcoded.

| MARS NO. | DESCRIPTION | MARS PACK |
|----------|---|-----------|
| 79350 | 1 1/4" round dia.glass mirror with 6" arm, adjustable angle | 1 |
| 79351 | 2 1/4 round dia.glass mirror with 10 1/2" arm, adjustable angle | 1 |
| 79352 | 1" x 2" oval glass mirror with 6" arm, adjustable angle | 1 |
| 79353 | 2 1/8" x 3-1/2" rectangle glass mirror with 11"-12" extendible arm | 1 |
| 79358 | 2 1/4" dia.round magnifying glass mirror with vinyl grip handle 14 1/2" | 1 |

EVERSPARK Electronic Igniter

Designed to fit your hand. Makes igniting any burner or torch quick & easy. Stands up to the most demanding field applications.

MARS # 79275 is designed for soldering, brazing, cutting, welding, plumbing, heating, refrigeration, air conditioning and process piping, etc...

MARS # 79274 is designed for use with natural or bottled gas. Applications include: hot water heaters, pilots, gas bbq's, gas logs, gas appliances, industrial, residential, camping & RV's.

| MARS NO. | DESCRIPTION | CASE QTY. |
|----------|-------------------------------------|-----------|
| 79275 | Everspark Torch Ignitor | 12 |
| 79274 | Everspark II Long Reach Gas Ignitor | 12 |



SERVICE & INSTALLATION

Compressor Terminal Repair Kit

MARS SERIES **862**



Compressor Terminal Repair Kit

Zebra Instruments offers a compressor terminal repair kit. The terminals are high-temp soldered to the 10ga. Fine strand, color coded wires for the best connection. These special terminals allow clearance for compressor post, and lay flat under the safety cover, Twist on wire nuts also provided.

| MARS NO. | DESCRIPTION | MARS PACK | CASE QTY. |
|----------|--|-----------|-----------|
| 08565 | Compressor Terminal Repair Kit 1 set of 3, terminals/wires/connectors | 1 | 24 |





Compressor Stake On Repair Kits

MARS SERIES **862**

MARS Compressor Stake On Repair Kits

MARS Term-Lok compressor stake on repair kits are designed with the technician in mind! During servicing of the air conditioning system or refrigeration system, it is not unusual for a technician to remove the compressor cover to find the electrical connector or spade terminal broken or melted away from the compressor. In reconnecting the electrical power, the metal plate is often found to have deteriorated to such an extent that the conventional female connector will no longer attach to the spade type male connector. Technology for reattaching a metal plate to the metal pin without damaging the encapsulated block is not normally available thus requiring the technician to attempt various types of crimping arrangements to avoid replacing the compressor assembly (which normally does not work).

The MARS Term-Lok is a brass cylindrical tube with a diameter large enough to slip over the pins and has a stainless set screw to lock onto the terminal. Term-Lok comes in packages of one or three terminal locks with color coded 65 strands, 600 volt permanently attached wire, with wrench provided for easy application. Once installed the compressor cover may be placed back over the terminals without any obstructions.

It takes approximately 15 minutes to install on most systems, thus saving the technician time and the customer money, with virtually no call backs.

| MARS NO. | DESCRIPTION | MFG. NO. | CASE QTY. |
|----------|----------------------------------|----------|-----------|
| 86386 | Brass stake on 12 gauge - 3 wire | TLC-3-12 | 1 |
| 86388 | Brass stake on 10 gauge - 3 wire | TLC-3-10 | 1 |
| 86390 | Brass stake on 8 gauge - 3 wire | TLC-3-8 | 1 |

Term-Lok

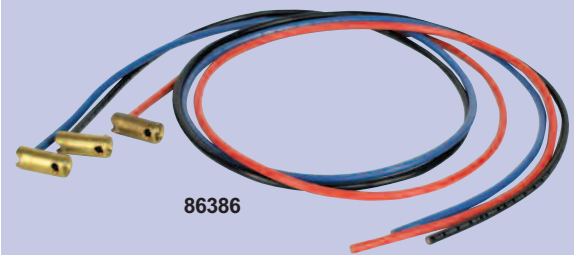

86386

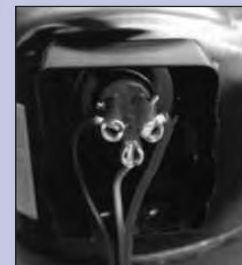

SERVICE & INSTALLATION



Solderless Terminals

MARS SERIES **862**

Quick Disconnects - Insulated (105°C)

MARS solderless terminals are competitively priced, yet manufactured of superior quality materials to rigid quality control standards. Seams are brazed to ensure perfect crimps EVERY TIME!

MARS solderless terminals are UL listed and CSA certified. Terminals are all manufactured in the USA. They are provided in clear, reclosable plastic display boxes. These attractive boxes, with clear and easy-to-read labels provide for visual inspection of the product and encourage impulse buying.

All packages display a MARS bar code for your convenience. MARS solderless terminals are available in two different package sizes. Both sizes enhance contractor self service. The MARS mini-pak display boxes contain very reasonable quantities with all types and sizes sold at one price. Perfect for the handyman, do-it-yourselfer and your sales and counter people. The MARS mini-pak is excellent for that small, unique HVACR odd job. The MARS super-pak contains much larger quantities of the more common solderless terminals at a super value. The contractor and tradesman will make great use of this size reclosable package. Ask your MARS sales representative about our solderless terminal merchandiser program!

| MARS NO. | MINI-PAK QTY | SIZE | DESCRIPTION | MARS NO. | SUPER PAK QTY. |
|----------|--------------|-------|-------------------------------------|----------|----------------|
| 86200 | 20 | 22-18 | .250 (1/4) female tab | 86500 | 100 |
| 86201 | 20 | 16-14 | .187 (3/16) female tab | 86501 | 100 |
| 86202 | 20 | 16-14 | .250 (1/4) female tab | 86502 | 100 |
| 86203 | 15 | 12-10 | .250 (1/4) female tab | 86503 | 50 |
| 86219 | 20 | 22-18 | .187 (3/16) female tab | | |
| 86205 | 20 | 16-14 | .250 (1/4) male tab | 86505 | 100 |
| 86207 | 12 | 22-18 | .250 (1/4) female full insul. | 86507 | 100 |
| 86208 | 12 | 16-14 | .250 (1/4) female full insul. | 86508 | 100 |
| 86209 | 8 | 12-10 | .250 (1/4) female full insul. | 86509 | 50 |
| 86220 | 7 | 16-14 | .250 (1/4) female flag fully insul. | 86520 | 25 |
| 86221 | 6 pair | | combo of #86208, 09 | | |
| 86211 | 12 | 16-14 | .250 (1/4) male fully insul. | | |
| 86216 | 12 | 22-18 | .250 (1/4) male/female p/back | | |
| 86217 | 12 | 16-14 | .250 (1/4) male/female p/back | 86517 | 100 |
| 86218 | 8 | 12-10 | .250 (1/4) male/female p/back | 86518 | 50 |



86200-03
86219

86205

86207-09

86211

86216-18



The largest selection of motors, components and accessories for the HVAC/R Industry

SI-77

Solderless Terminals

MARS SERIES **862**



Quick Disconnects - Non-Insulated (149°C)

| MARS NO. | MINI-PAK QTY. | SIZE | DESCRIPTION | MARS NO. | SUPER-PAK QTY. |
|----------|---------------|-------|------------------------|----------|----------------|
| 86226 | 25 | 16-14 | .250 (1/4) female tab | 86526 | 100 |
| 86229 | 25 | 16-14 | .250 (1/4) female flag | 86529 | 100 |
| 86236 | 13 | 12-10 | .250 (1/4) female flag | | |

Quick Disconnects - Hi Temp To 900°F

| MARS NO. | MINI-PAK QTY. | SIZE | DESCRIPTION | MARS NO. | SUPER-PAK QTY. |
|----------|---------------|-------|---------------------------|----------|----------------|
| 86239 | 15 | 16-14 | .250 (1/4) female tab | | |
| 86240 | 12 | 12-10 | .250 (1/4) female tab | | |
| 86241 | 15 | 16-14 | .250 (1/4) female w/crimp | | |
| 86242 | 15 | 16-14 | .250 (1/4) female flag | | |
| 86243 | 10 | 12-10 | .250 (1/4) female flag | | |
| | | 16-14 | .187 (3/16) male tab | 86544 | 100 |

Rings - Insulated (105°C)

| MARS NO. | MINI-PAK QTY. | SIZE | DESCRIPTION | MARS NO. | SUPER-PAK QTY. |
|----------|---------------|-------|---------------------|----------|----------------|
| 86251 | 20 | 22-18 | #8 stud 11/64 i.d. | 86551 | 100 |
| 86252 | 20 | 22-18 | #10 stud 13/64 i.d. | | |
| 86253 | 20 | 16-14 | #6 stud 9/64 i.d. | | |
| 86254 | 20 | 16-14 | #8 stud 11/64 i.d. | 86554 | 100 |
| 86255 | 20 | 16-14 | #10 stud 13/64 i.d. | 86555 | 100 |
| 86258 | 12 | 12-10 | #8 stud 11/64 i.d. | | |
| 86259 | 12 | 12-10 | #10 stud 13/64 i.d. | 86559 | 50 |
| 86260 | 12 | 12-10 | 1/4 stud 17/64 i.d. | | |
| 86262 | 5 | 8 | 1/4 stud 17/64 i.d. | 86562 | 25 |
| 86263 | 3 | 6 | 1/4 stud 17/64 i.d. | | |

Rings - Non-Insulated (149°C)

| MARS NO. | MINI-PAK QTY. | SIZE | DESCRIPTION | MARS NO. | SUPER-PAK QTY. |
|----------|---------------|-------|---------------------|----------|----------------|
| 86275 | 15 | 22-18 | #10 stud 13/64 i.d. | 86569 | 100 |
| | | 12-10 | #10 stud 13/64 i.d. | | |

Rings - High Temp To 900°F

| MARS NO. | MINI-PAK QTY. | SIZE | DESCRIPTION |
|----------|---------------|-------|---------------------|
| 86283 | 20 | 16-14 | #10 stud 13/64 i.d. |
| 86285 | 15 | 12-10 | #10 stud 13/64 i.d. |



SERVICE & INSTALLATION



Spade Flanged - Insulated (105°C)

| MARS NO. | MINI-PAK QTY. | SIZE | DESCRIPTION |
|----------|---------------|-------|---------------------|
| 86294 | 15 | 16-14 | #10 stud 13/64 i.d. |
| 86295 | 12 | 12-10 | #10 stud 13/64 i.d. |

Spade - Insulated (105°C)

| MARS NO. | MINI-PAK QTY. | SIZE | DESCRIPTION | MARS NO. | SUPER-PAK QTY. |
|----------|---------------|-------|---------------------|----------|----------------|
| 86300 | 20 | 22-18 | #8 stud 11/64 i.d. | 86600 | 100 |
| 86303 | 20 | 16-14 | #8 stud 11/64 i.d. | 86603 | 100 |
| 86304 | 20 | 16-14 | #6 stud 9/64 i.d. | | |
| 86301 | 15 | 16-14 | #10 stud 13/64 i.d. | 86601 | 100 |
| 86302 | 12 | 12-10 | #10 stud 13/64 i.d. | 86602 | 50 |

Spade Flanged - Non- Insulated (149°C)

| MARS NO. | MINI-PAK QTY. | SIZE | DESCRIPTION |
|----------|---------------|-------|---------------------|
| 86307 | 20 | 22-18 | #8 stud 11/64 i.d. |
| 86308 | 20 | 22-18 | #10 stud 13/64 i.d. |

Spade - Non- Insulated (149°C)

| MARS NO. | MINI-PAK QTY. | SIZE | DESCRIPTION |
|----------|---------------|-------|---------------------|
| 86315 | 25 | 22-18 | #10 stud 13/64 i.d. |
| 86317 | 15 | 12-10 | #10 stud 13/64 i.d. |

Spade Hi Temp To 900°F

| MARS NO. | MINI-PAK QTY. | SIZE | DESCRIPTION | MARS NO. | SUPER-PAK QTY. |
|----------|---------------|-------|---------------------|----------|----------------|
| 86323 | 20 | 16-14 | #10 stud 13/64 i.d. | 86623 | 100 |

Butt Connectors And Plugs And Receptacles

| MARS NO. | MINI-PAK QTY. | SIZE | DESCRIPTION | MARS NO. | SUPER-PAK QTY. |
|----------|---------------|-------|--------------------------|----------|----------------|
| 86329 | 20 | 22-18 | Insulated | 86629 | 100 |
| 86330 | 20 | 16-14 | Insulated | 86630 | 100 |
| 86331 | 15 | 12-10 | Insulated | 86631 | 50 |
| | | 16-14 | Non-insulated | 86633 | 100 |
| 86334 | 20 | 12-10 | Non-insulated | | |
| | | 8 | Non-insulated | 86635 | 25 |
| | | 22-18 | Plug insulated | 86637 | 50 pairs |
| | | 16-14 | Recept - fully insulated | | |
| | | | Plug insulated | 86638 | 50 pairs |
| | | | Recept - fully insulated | | |



Solderless Terminals

MARS SERIES **862 & 930**



Closed End Connectors (105°C)

| MARS NO. | MINI-PAK QTY. | SIZE | DESCRIPTION | MARS NO. | SUPER-PAK QTY. |
|----------|---------------|-------|----------------------|----------|----------------|
| 86341 | 25 | 22-18 | Insulated crimp type | | |
| 86342 | 20 | 16-14 | Insulated crimp type | 86642 | 100 |
| 86343 | 15 | 12-10 | Insulated crimp type | 86643 | 50 |

Tab Adapters - Non Insulated (149°C)

| MARS NO. | MINI-PAK QTY. | SIZE | DESCRIPTION | MARS NO. | SUPER-PAK QTY. |
|----------|---------------|------|----------------------------------|----------|----------------|
| 86350 | 20 | - | .250 (1/4) 2 male x 1 female | 86650 | 100 |
| 86351 | 15 | - | .250 (1/4) 2 male x 1 female | 86651 | 50 |
| | | | 8 stud, male tab, straight, .250 | | |
| 86353 | 12 | - | .250 (1/4) 2 male x 1 female | | |

Compressor Terminals - Non Insulated (149°C)

| MARS NO. | MINI-PAK QTY. | SIZE | DESCRIPTION | MARS NO. | SUPER-PAK QTY. |
|----------|---------------|-------|------------------------------------|----------|----------------|
| 86358 | 13 | 12-10 | .250 (1/4) tab notched for bending | 86658 | 50 |
| 86359 | 8 | 12-8 | .250 (1/4) tab | 86659 | 50 |

Spade Spring - Insulated (105°C)

| MARS NO. | MINI-PAK QTY. | SIZE | DESCRIPTION | MARS NO. | SUPER-PAK QTY. |
|----------|---------------|-------|-------------|----------|----------------|
| 86366 | 20 | 16-14 | #8 stud | 86666 | 100 |
| 86367 | 20 | 16-14 | #6 stud | | |

Line Tap Connectors

| MARS NO. | MINI-PAK QTY. | SIZE | DESCRIPTION |
|----------|---------------|-------|-------------|
| 86373 | 8 | 18-14 | tap blue |

Compressor Terminal W/Wire Kit

| MARS NO. | DESCRIPTION | MARS PACK |
|----------|---|-----------|
| 86379 | Includes 3 color coded #10AWG type AWM extra flexible lead wires in 10" lengths. One end with .250" x .032" female tab 12-10 quick disconnect. Other end stripped 5/16". Supplied with three 12-10 shrink tube butt connectors. | 1 |

Push-On Terminal Kit

The MARS push on terminal kit includes; four push on terminal adapters and four screws. Converts screw type terminals to push on. Use with the MARS 18000 series contactors.

| MARS NO. | DESCRIPTION | MARS PACK |
|----------|---|-----------|
| 93103 | (4) push on terminal adapters (4) screws | 1 |



SERVICE & INSTALLATION



Slic-Tite® paste - thread sealants

- Contains more Teflon particles for greater sealing power • Use on metal, PVC, CPVC, and ABS plastic pipe threads • For sealing water, air, steam, natural gas, LP gas, refrigerants, ammonia, gasoline, and oil
- Do not use on Oxygen service, use Teflon tape or Oxytite® Paste • Washes off hands and clothing easily • Non-toxic, non-drying • Sealing temperature range: -50° F to 500° F (-46° C to 260° C)
- Working pressures: 3,000 PSI (204 BAR) for Gas, 10,000 PSI (680 BAR) for liquids
- USDA approved for use in federally inspected meat and poultry plants.

| MARS NO. | DESCRIPTION | MARS PACK | CASE QTY. |
|----------|---------------------|-----------|-----------|
| 95400* | 1.5 oz. tube | 12 | 24 |
| 95401 | 1/4 pt. w/ brushcap | 24 | 24 |
| 95402 | 1/2 pt. w/ brushcap | 24 | 24 |
| 95403 | 1 pt. w/ brushcap | 24 | 24 |
| 95406 | 1qt. w/ brushcap | 12 | 12 |

* packaged in one dozen per display box

Slic-Tite® Stik w/ Teflon - Thread Sealant

- PTFE thread compound in handy stick form • use on metal and PVC pipe thread connections for water, air, natural gas, steam, gasoline, oil, refrigerants and ammonia
- Do not use on Oxygen service, use Teflon tape • working pressures: 5,000 PSI (340 BAR) - liquid to 500 PSI (34 BAR) -gas
- Temperature range: -50° F to 350° F (-46° C to 177° C)

| MARS NO. | DESCRIPTION | MARS PACK | CASE QTY. |
|----------|-----------------|-----------|-----------|
| 95407* | 1 1/4 oz. stick | 12 | 24 |

* packaged in one dozen per display box

Low Density Teflon Tape

- Thickness 3 mils. • Standard grade, low density
- Provides a highly resistant seal on pipe threads for all types of service
- Suitable for use with solvents, chemicals, oxygen, and on food lines
- Non-toxic • Permits easy disassembly, even after years of service
- Meets Mil. Spec. T-27730A
- Sealing temperature range: -450° F to 550° F (-268° C to 288° C)
- Working pressures: 2,000 PSI (136 BAR)
- Sold in case quantities only

| MARS NO. | DESCRIPTION | MARS PACK | CASE QTY. |
|----------|-------------|-----------|-----------|
| 95409 | 1/2" x 260" | 144 | 144 |
| 95410 | 1/2" x 520" | 144 | 144 |
| 95412 | 3/4" x 520" | 144 | 144 |

High Density Slic-Tite® Teflon Tape

- Thickness 3 mils. • High density
- Provides a highly resistant seal on pipe threads for all types of service
- Made in USA • Suitable for use with solvents, chemicals, oxygen, and on food lines
- Non-toxic • Permits easy disassembly, even after many years
- Meets Mil. Spec. T-27730A
- Sealing temperature range: -450° F to 550° F, (-268° C to 288° C)
- Working pressures: 2,000 PSI (136 BAR)

| MARS NO. | DESCRIPTION | MARS PACK | CASE QTY. |
|----------|-------------|-----------|-----------|
| 95525 | 1/4" x 300" | 12 | 12 |
| 95526 | 1/4" x 600" | 12 | 12 |
| 95527 | 1/2" x 300" | 12 | 12 |
| 95528 | 1/2" x 600" | 12 | 12 |
| 95530 | 3/4" x 300" | 12 | 12 |
| 95532 | 1" x 300" | 12 | 12 |



LA·CO®

95402

95407

95409

95528

SERVICE & INSTALLATION

Plumbing & Piping Products

MARS SERIES **954**



SERVICE & INSTALLATION

T.O.T.® Pipe Joint Compound

- No-drip, siliconized for fast application on metal threads
- For water, steam, air, and natural gas service
- Lead free, non-toxic
- Certified by NSF to meet ANSI/NSF Std. 61 for use on potable water
- Do not use on Oxygen service, use Teflon® tape or Oxytite
- Sealing temperature: up to 350° F (177° C)
- Working pressures: to 500 PSI (34 BAR) for liquids to 350 PSI (24 BAR) for gases

| MARS NO. | DESCRIPTION | MARS PACK | CASE QTY. |
|----------|---------------------|-----------|-----------|
| 95415 | 1/2 pt. w/ brushcap | 48 | 48 |

Pipetite® Paste - Pipe Thread Compound

- Soft set pipe thread compound
- For refrigerants, butane, gasoline, oil, as well as water, steam, air, natural and lp gas
- Use on metal threads
- Classified by Underwriters Laboratories in USA and Canada
- Do not use on oxygen service, use Teflon® or Oxytite®
- Sealing temperature: up to 400° F (204° C)
- Pressures: to 5,000 PSI (340 BAR) for liquids to 2,600 PSI (177 BAR) for gases

| MARS NO. | DESCRIPTION | MARS PACK | CASE QTY. |
|----------|---------------------|-----------|-----------|
| 95419 | 1/4 pt. w/brush cap | 24 | 24 |
| 95420 | 1/2 pt. w/brush cap | 24 | 24 |

Anaerobic Pipe Thread Sealant

- Contains Teflon® for a positive seal
- Anaerobic adhesive provides locking power
- Contains no solvents, won't shrink and weaken seal
- Seals and locks in the absence of air
- Ideal for threads in heavy vibration areas such as compressors and reciprocating equipment
- Classified by Underwriters Laboratories in USA and Canada
- Do not use on Oxygen service, use Teflon® tape or Oxytite
- Sealing temperature range: -65° F to 400° F (-54° C to 204° C)
- Working pressures: to 10,000 PSI (680 BAR) for liquids to 3,000 PSI (204 BAR) for gases

| MARS NO. | DESCRIPTION | MARS PACK | CASE QTY. |
|----------|-------------------|-----------|-----------|
| 95421 | 50 ml (1.69 oz.) | 12 | 12 |
| 95422 | 250 ml (8.45 oz.) | 6 | 6 |

Teflon Cords

- Use as packing for faucets, valves, pumps, etc. Also as gasket between flanges
- Smaller sizes come packaged in a unique Visu-Kit that keeps cord clean and ready for use. The durable kit can be mounted over the work bench or carried in a tool box
- Sealing temperature range: -450° F to 550° F (-268° C to 288° C)

| MARS NO. | DESCRIPTION | MARS PACK | CASE QTY. |
|----------|-------------|-----------|-----------|
| 95425 | 3/32" x 50' | 6 | 6 |
| 95426 | 5/32" x 50' | 6 | 6 |
| 95427 | 7/32" x 10' | 6 | 6 |

LA-CO®

95415



95420



95421



95425

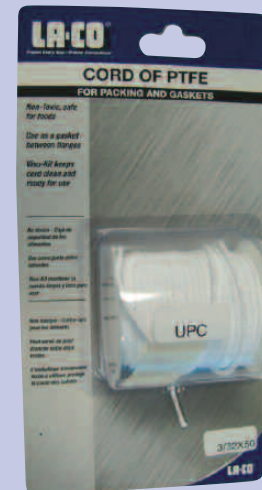



Heat-Seal Stik®

- Fast repairs completed in 90 seconds
- One part epoxy, no mixing or measuring needed
- Stick melts, seals and cures in one operation
- Use on aluminum, copper and other metals, glass and ceramics
- Ideal for use on high and low side of refrigeration systems
- Sealing temperature : up to 350° F (177° C)
- Pressures: to 600 PSI (41 Bar)

| MARS NO. | DESCRIPTION | MARS PACK | CASE QTY. |
|----------|-----------------------|-----------|-----------|
| 95430 | 3/8 oz. stick, carded | 12 | 12 |

Bloc-it® Heat Absorbing Paste

- Effectively absorbs surface heat
- Protects adjoining surfaces that may be damaged by excessive heat
- Safe to use: non-toxic, no asbestos, harmless to skin, and odorless
- Easy to use: apply directly to surface from tube
- Easy to clean: wipe off with cloth or wash with water. Leaves no stains
- Typical uses: protects rubber and plastic components in ball, dielectric, and solenoid valves during soldering; protects painted or finished surfaces from adjacent soldering, brazing or welding; prevents distortion to light gauge metals during brazing or welding

| MARS NO. | DESCRIPTION | MARS PACK | CASE QTY. |
|----------|-------------|-----------|-----------|
| 95455 | 10 oz. tube | 24 | 24 |

Cool Gel - Heat Dissipating Spray

- Helps prevent heat damage to components and surrounding materials during soldering, brazing, and welding
- Unique gelled formula sticks to surfaces without dripping or running off
- Clear, non-staining gel leaves no residue, eliminating cleanup
- Safe, non-toxic, harmless to skin and odorless
- Saves time - by eliminating the costly disassembly of valves and other components before soldering, brazing or welding
- Protects the seals and seats in ball, dielectric, and solenoid valves
- Protects painted and finished surfaces from discoloration due to adjacent torch operations
- Protects soldered joints from loosening when soldering adjacent joints

| MARS NO. | DESCRIPTION | MARS PACK | CASE QTY. |
|----------|-------------|-----------|-----------|
| 95536 | 1 quart | 12 | 12 |

Regular Flux Paste

- Super detergent action cleans as it solders
- Non-acid, non-toxic, lead free
- Contains no zinc chloride
- Use with all common soft solders including: tin-silver, 96/4, 94/6, 95/5, 50/50, 40/60 and 60/40
- For use on copper, brass, galvanized iron, lead, zinc, tin, silver, nickel, mild steel, terne plate, and malleable iron
- Meets Mil. Spec. Mil-F4995 Type II, Meets ASTM B813
- Water soluble for faster flushing from pipe lines

| MARS NO. | DESCRIPTION | MARS PACK | CASE QTY. |
|----------|------------------|-----------|-----------|
| 95441 | 2 oz | 48 | 48 |
| 95443 | 4 oz. w/brushcap | 48 | 48 |
| 95444 | 1 lb | 24 | 24 |



95430



95455



95536



95443

Plumbing & Piping Products

MARS SERIES **954**



Silver Brazing Flux Paste

- Powerful cleaning action reduces waste of expensive silver solders
- Packed in break-resistant plastic jars
- Use with torch, furnace, resistance or induction heating
- Meets Mil. Spec. MIL-F-4883
- Certified by NSF to meet ANSI/NSF Std. 61 for use on potable water
- Temperature range: 1000° F to 1700° F (538° C to 927° C)

| MARS NO. | DESCRIPTION | MARS PACK | CASE QTY. |
|----------|------------------|-----------|-----------|
| 95448 | 2 oz. | 48 | 48 |
| 95449 | 6 oz. w/brushcap | 24 | 24 |

Regular Soldering Flux Liquid

- Contains no zinc chloride or other heavy metal chloride
- Non-acid, non-toxic, lead free
- Use with new lead-free, tin/silver, plus 40/60, 50/50, 60/40 and 95/5 solders
- For high speed production and mechanized soldering equipment
- For use on copper, galvanized iron, sheet lead, zinc, nickel, tin, silver, mild steel, terne plate, malleable iron
- Packed in break resistant plastic bottles

| MARS NO. | DESCRIPTION | MARS PACK | CASE QTY. |
|----------|-------------|-----------|-----------|
| 95445 | 1 qt. | 12 | 12 |

Aluminum Flux Paste & Solder Kit

- Complete repair kit for tradesmen and repairmen
- Solders aluminum easily
- For repairing aluminum evaporators and tubing, ducts, and gutters
- Also solders aluminum to copper
- Blister carded for impulse sales

| MARS NO. | DESCRIPTION | MARS PACK | CASE QTY. |
|----------|---|-----------|-----------|
| 95454 | 1 oz. of alum. flux and 1/2 oz. of #60 solder | 12 | 12 |

Flux-Rite 90® Flux

- Meets ASTM B-813
- Completely water soluble for faster flushing from pipe lines
- Super detergent action cleans as it solders
- Non-acid, non-toxic, lead-free
- Contains no zinc chloride
- Use with all common soft solders including: tin-silver, 96/4, 94/6, 95/5, 50/50, 40/60 and 60/40
- For use on copper, brass, galvanized iron, lead, zinc, tin, silver, nickel, mild steel, terne plate, and malleable iron

| MARS NO. | DESCRIPTION | MARS PACK | CASE QTY. |
|----------|-------------|-----------|-----------|
| 95456 | 4 oz. | 24 | 24 |

Visu-Glow® Leak Detector

- High visibility, fluorescent color shows brightly, even in dimly lit places
- High viscosity, stays on vertical surfaces
- Makes it easy to find leaks
- Temperature range: 15° F to 200° F (-9° C to 93° C)
- Safe for oxygen
- Non-corrosive, non-toxic

| MARS NO. | DESCRIPTION | MARS PACK | CASE QTY. |
|----------|-------------|-----------|-----------|
| 95462 | 8 oz. | 24 | 24 |

Sure-Check® All Temperature Leak Detector

- All temperature formula: -55° F to 200° F (-48° C to 93° C)
- Ultra-sensitive, long-lasting bubbles
- Available in handy spray bottle
- Fluorescent for improved visibility
- Safe for oxygen
- Non-corrosive, non-toxic
- Green liquid

| MARS NO. | DESCRIPTION | MARS PACK | CASE QTY. |
|----------|-------------|-----------|-----------|
| 95466 | 1 pint | 24 | 24 |
| 95468 | 1 quart | 12 | 12 |

LA-CO®



95449



95445



95454

95456



95466



95462

SERVICE & INSTALLATION



Residential Self Regulating Pipe Tracing Cable

- Cut to length (3 watts/ft @ 120VAC) up to 75 ft.
- Braided metal jacket for dry location application
- Connection kit provides end seal and plugs into standard 120 VAC outlet
- Automatically varies heat output with changes in surrounding temperature
- For use on plastic or metal pipes

| MARS NO. | DESCRIPTION | MARS PACK | CASE QTY. |
|----------|---------------------------------|-----------|-----------|
| 70701 | 100' Reel | 1 | 1 |
| 70704 | Connection Kit | 1 | 10 |
| 70705 | Pre-set Thermostat (38 degrees) | 1 | 10 |

Commercial Pipe Freeze Protection Cable

- No thermostat, no plug
- 2 foot orange 14/3 cold lead
- Jacketed for wet or dry applications
- 120 VAC unless noted
- For use on metal pipes only

| MARS NO. | DESCRIPTION | MARS PACK | CASE QTY. |
|----------|---------------------------------|-----------|-----------|
| 70720 | 3.28' length, 23 watts | 1 | 20 |
| 70721 | 6.56' length, 46 watts | 1 | 20 |
| 70722 | 6.56' length, 46 watts (240V) | 1 | 20 |
| 70723 | 9.84' length, 69 watts | 1 | 20 |
| 70724 | 13.12' length, 92 watts | 1 | 20 |
| 70725 | 13.12' length, 92 watts (240V) | 1 | 20 |
| 70726 | 16.41' length, 115 watts | 1 | 20 |
| 70727 | 19.69' length, 138 watts | 1 | 20 |
| 70728 | 19.69' length, 138 watts (240V) | 1 | 20 |
| 70729 | 22.97' length, 161 watts | 1 | 10 |
| 70730 | 26.25' length, 184 watts (240V) | 1 | 10 |
| 70731 | 29.53' length, 207 watts | 1 | 10 |
| 70732 | 32.81' length, 230 watts (240V) | 1 | 10 |

Residential Pipe Freeze Protection Cable

- For use on plastic or metal pipes
- Jacketed for wet or dry applications
- Preassembled ready to install
- Plugs into standard 120 VAC outlet
- Built-In fixed thermostat

| MARS NO. | DESCRIPTION | MARS PACK | CASE QTY. |
|----------|-----------------------|-----------|-----------|
| 70710 | 3' length, 21 watts | 1 | 10 |
| 70711 | 6' length, 42 watts | 1 | 10 |
| 70712 | 9' length, 63 watts | 1 | 10 |
| 70713 | 12' length, 84 watts | 1 | 10 |
| 70714 | 15' length, 105 watts | 1 | 10 |
| 70715 | 18' length, 126 watts | 1 | 5 |
| 70716 | 24' length, 168 watts | 1 | 5 |
| 70717 | 30' length, 210 watts | 1 | 5 |
| 70718 | 40' length, 280 watts | 1 | 5 |



SERVICE & INSTALLATION

Commercial Sr Trace Self Regulating Pipe Tracing Cable

- Cut to length, up to 458' (120VAC)
- Wet (J jacket) or dry (copper braid) applications
- Automatically varies heat output with changes in surrounding temperature

| MARS NO. | DESCRIPTION | MARS PACK | CASE QTY. |
|----------|---|-----------|-----------|
| 70742 | 250' reel, J jacket 5 watts/ft, (120V) | 1 | 1 |
| 70743 | 250' reel, J jacket 5 watts/ft (240V) | 1 | 1 |
| 70744 | Heat shrink end seal kit | 1 | 5 |
| 70745 | Heat shrink power/end connection kit | 1 | 1 |
| 70746 | Heat shrink splice and "T" connection kit | 1 | 2 |
| 70747 | 250' reel, CB Jacket (120V) | 1 | 1 |

Hose Clamps

MARS SERIES **783**



Ideal 52 Series - 1/2" Clamps

Ideal manufacturers a broad line of standard worm drive and specialty hose clamps designed to satisfy a wide range of applications. The completely mechanical design locks the one piece housing directly to the band using the full strength of the material to provide maximum anti-shear protection. No spot welds to rupture under stress or corrosion, and a one piece housing can not come apart under high loading.

Ideal's 52 series clamps are comprised of a 1/2" stainless steel band with carbon steel housing and a 5/16" plated hex head screw.

| MARS NO. | DESCRIPTION | MARS PACK | CASE QTY. |
|----------|-----------------------------------|-----------|-----------|
| 79310 | Size 06 3/8"-7/8" clamp dia. | 10 | 100 |
| 79311 | Size 08 7/16"-1" clamp dia. | 10 | 100 |
| 79312 | Size 10 1/2"-1 1/8" clamp dia. | 10 | 100 |
| 79313 | Size 12 1/2"-1 1/4" clamp dia. | 10 | 100 |
| 79314 | Size 16 3/4"-1 1/2" clamp dia. | 10 | 100 |
| 79315 | Size 20 3/4"-1 3/4" clamp dia. | 10 | 100 |
| 79317 | Size 24 1"-2" clamp dia. | 10 | 100 |
| 79318 | Size 28 1 5/16"-2-1/4" clamp dia. | 10 | 100 |
| 79316 | Size 32 1 9/16"-2 1/2" clamp dia. | 10 | 100 |
| 79319 | Size 36 7/8"-2 3/4" clamp dia. | 10 | 100 |
| 79345 | Size 40 1-1/8"-3" clamp dia. | 10 | 100 |
| 79309 | Size 72 3-1/8"-5" clamp dia. | 10 | 100 |

Ideal 67-5 Series 1/2" Clamps

Ideal's 67-5 series clamps are all stainless steel. They are comprised of a 1/2" 300 series stainless steel band, housing and a 5/16 hex head screw.

| MARS NO. | DESCRIPTION | MARS PACK | CASE QTY. |
|----------|-----------------------------------|-----------|-----------|
| 79320 | Size 06 3/8"-7/8" clamp dia. | 10 | 100 |
| 79321 | Size 08 7/16"-1" clamp dia. | 10 | 100 |
| 79322 | Size 10 1/2"-1 1/8" clamp dia. | 10 | 100 |
| 79323 | Size 12 1/2"-1 1/4" clamp dia. | 10 | 100 |
| 79324 | Size 16 3/4"-1 1/2" clamp dia. | 10 | 100 |
| 79325 | Size 20 3/4"-1 3/4" clamp dia. | 10 | 100 |
| 79328 | Size 24 1"-2" clamp dia. | 10 | 100 |
| 79307 | Size 28 1 5/16"-2 1/4" clamp dia. | 10 | 100 |
| 79326 | Size 32 1 9/16"-2 1/2" clamp dia. | 10 | 100 |
| 79327 | Size 36 7/8"-2 3/4" clamp dia. | 10 | 100 |
| 79308 | Size 72 3"-5" clamp dia. | 10 | 100 |
| 79304 | Size 128 6 1/2"-8 1/2" clamp dia. | 50 | 100 |
| 79305 | Size 152 8"-10" clamp dia. | 50 | 100 |
| 79306 | Size 188 10"-12" clamp dia. | 50 | 50 |

Ideal 50" All Stainless 1/2" Clamp For Ducts

| MARS NO. | DESCRIPTION | MARS PACK | CASE QTY. |
|----------|-----------------------------|-----------|-----------|
| 79329 | Size 248 14"-16" clamp dia. | 50 | 100 |

IDEAL





Hose Clamps & Merchandisers

MARS SERIES **783**

Ideal 52 Series Micro Gear Clamps

Ideal's 52 series micro-gear clamps consist of a 5/16" stainless steel band with carbon steel housing and 1/4" plate hex-head screw.

| MARS NO. | DESCRIPTION | MARS PACK | CASE QTY. |
|----------|-----------------------------------|-----------|-----------|
| 79330 | Size 04 7/32"-5/8" clamp dia. | 10 | 100 |
| 79331 | Size 06 5/16"-7/8" clamp dia. | 10 | 100 |
| 79332* | Size 12 9/16"-1 1/4" clamp dia. | 10 | 100 |
| 79333* | Size 16 11/16"- 1 1/2" clamp dia. | 10 | 100 |
| 79334* | Size 20 7/8"-1 3/4" clamp dia. | 10 | 100 |

* size 12 and larger have a stainless steel housing

Ideal 62M Series Micro Gear Clamps

Ideal's 62M series micro gear clamps are all stainless. They are comprised of a 5/16" stainless steel band, housing and 1/4" hex-head screw.

| MARS NO. | DESCRIPTION | MARS PACK | CASE QTY. |
|----------|----------------------------------|-----------|-----------|
| 79340 | Size 04 7/32"-5/8" clamp dia. | 10 | 100 |
| 79341 | Size 06 5/16"-7/8" clamp dia. | 10 | 100 |
| 79342 | Size 12 9/16"-1 1/4" clamp dia. | 10 | 100 |
| 79343 | Size 16 11/16"-1 1/2" clamp dia. | 10 | 100 |
| 79344 | Size 20 7/8"-1 3/4" clamp dia. | 10 | 100 |



IDEAL

SERVICE & INSTALLATION

Flexible Gas Appliance Fittings & Valves

MARS SERIES **734 & 643**



Flexible Stainless Steel Gas Range Connectors 1/2" I.D. (5/8" O.D.) With Fittings

Brass Craft coated stainless steel gas connectors are known for superior quality and reliable performance. The ProCoat polymer based yellow coating resists corrosion from sea, salt, UV rays and the harsh chemical vapors from common household cleaning, plumbing repair and building products such as: ammonia, chlorine, solder flux, muratic acid, and bleach. These ProCoat gas connectors provide great strength and flexibility making installation easier.

| MARS NO. | DESCRIPTION | MARS PACK | CASE QTY. |
|----------|--------------------------|-----------|-----------|
| 73402 | 18"L-1/2" MIP x 1/2" MIP | 1 | 25 |
| 73403 | 24"L-1/2" MIP x 1/2" MIP | 1 | 25 |
| 73404 | 36"L-1/2" MIP x 1/2" MIP | 1 | 25 |
| 73405 | 48"L-1/2" MIP x 1/2" MIP | 1 | 25 |
| 73410 | 24"L-3/4" FIP x 3/4" FIP | 1 | 25 |
| 73411 | 36"L-3/4" FIP x 3/4" FIP | 1 | 25 |
| 73412 | 48"L-3/4" FIP x 3/4" FIP | 1 | 25 |
| 73418 | 36"L-1/2" FIP x 1/2" FIP | 1 | 25 |
| 73419 | 48"L-1/2" FIP x 1/2" FIP | 1 | 25 |
| 73422 | 12"L-3/4" FIP x 3/4" MIP | 1 | 25 |
| 73423 | 18"L-3/4" FIP x 3/4" MIP | 1 | 25 |
| 73424 | 24"L-3/4" FIP x 3/4" MIP | 1 | 25 |
| 73425 | 36"L-3/4" FIP x 3/4" MIP | 1 | 25 |
| 73426 | 48"L-3/4" FIP x 3/4" MIP | 1 | 25 |
| 73427 | 60"L-3/4" FIP x 3/4" MIP | 1 | 25 |
| 73429 | 12"L-1/2" FIP x 1/2" MIP | 1 | 25 |
| 73430 | 18"L-1/2" FIP x 1/2" MIP | 1 | 25 |
| 73431 | 24"L-1/2" FIP x 1/2" MIP | 1 | 25 |
| 73432 | 36"L-1/2" FIP x 1/2" MIP | 1 | 25 |
| 73433 | 48"L-1/2" FIP x 1/2" MIP | 1 | 25 |
| 73434 | 60"L-1/2" FIP x 1/2" MIP | 1 | 12 |

Flexible Stainless Steel Gas Dryer Connectors 3/8" I.D. (1/2" O.D.) With Fittings

| MARS NO. | DESCRIPTION | MARS PACK | CASE QTY. |
|----------|--------------------------|-----------|-----------|
| 73438 | 24"L-1/2" MIP x 1/2" MIP | 1 | 25 |
| 73439 | 36"L-1/2" MIP x 1/2" MIP | 1 | 25 |
| 73440 | 48"L-1/2" MIP x 1/2" MIP | 1 | 25 |
| 73445 | 24"L-1/2" FIP x 1/2" MIP | 1 | 25 |
| 73446 | 36"L-1/2" FIP x 1/2" MIP | 1 | 25 |
| 73447 | 48"L-1/2" FIP x 1/2" MIP | 1 | 25 |
| 73448 | 60"L-1/2" FIP x 1/2" MIP | 1 | 12 |

Flexible Stainless Steel Gas Dryer Connectors 3/8" I.D. (1/2" O.D.) With Valves

| MARS NO. | DESCRIPTION | MARS PACK | CASE QTY. |
|----------|-------------------------------|-----------|-----------|
| 73457 | 18"L-1/2" MIP x 1/2" FIP-BALL | 1 | 25 |
| 73458 | 24"L-1/2" MIP x 1/2" FIP-BALL | 1 | 25 |
| 73459 | 36"L-1/2" MIP x 1/2" FIP-BALL | 1 | 25 |

Flexible Stainless Steel Gas Heater Connectors 1/4" I.D. (3/8" O.D.) With Fittings

| MARS NO. | DESCRIPTION | MARS PACK | CASE QTY. |
|----------|--------------------------|-----------|-----------|
| 73461 | 12"L-1/2" FIP x 1/2" MIP | 1 | 25 |
| 73464 | 36"L-1/2" FIP x 1/2" MIP | 1 | 25 |

Steel Gas Fittings For 7/8" O.D. Connectors

With MARS male gas fittings, wholesalers need fewer items on the shelf and contractors need fewer parts on the job. Tapped gas fittings hook up gas connectors to male or female iron pipe and female in-line gas valves. One fitting does many jobs.

| MARS NO. | DESCRIPTION | MARS PACK | CASE QTY. |
|----------|--|-----------|-----------|
| 73480 | straight-5/8" OD x 1/2" MIP (tapped 3/8" FIP) | 25 | 25 |
| 73481 | straight-5/8" OD x 3/4" MIP (tapped 1/2" FIP) | 25 | 25 |

Steel Gas Fittings For 1/2" O.D. Connectors

| MARS NO. | DESCRIPTION | MARS PACK | CASE QTY. |
|----------|-----------------------------|-----------|-----------|
| 73483 | straight-1/2" OD x 1/2" FIP | 25 | 25 |

MARS Gas Ball Valves

MARS gas ball valves are for use with natural, manufactured and mixed gases, as well as liquified petroleum and LP gas/air mixtures. Corrosion fighting chrome plated brass ball and aluminum, quarter turn handle. MARS gas ball valves feature threads that conform to all appropriate standards.

| MARS NO. | DESCRIPTION | MARS PACK | CASE QTY. |
|----------|------------------------------|-----------|-----------|
| 73492 | straight-1/2" OD x 1/2" FIP | 10 | 10 |
| 73494 | straight-5/8" OD x 3/4" FIP | 10 | 10 |
| 73495 | straight-1/2" FIP x 1/2" FIP | 10 | 10 |
| 73496 | straight-3/4" FIP x 3/4" FIP | 10 | 10 |

NIBCO Gas Ball Valves - Type GB1

- Tamper proof brass ball valve
- Female x Female threads
- Lever Handle
- 5 psi for indoor shutoff
- 1/2 psi for indoor appliance connections
- AGA 3-88, CGA 9.1, CGA 9.2, CR91-002, ANSI Z21.15

| MARS NO. | NOM. SIZE | DIMENSIONS (INCHES) | | | | MARS PACK | CASE QTY. |
|----------|-----------|---------------------|------|------|------|-----------|-----------|
| | | A | B | C | D | | |
| 64317 | 1/2 | 2.21 | 1.34 | 1.93 | 0.47 | 20 | 120 |
| 64318 | 3/4 | 2.38 | 1.41 | 1.93 | 0.59 | 10 | 120 |

MARS Cross Reference Guide

| MARS NO. | NIBCO | MUELLER | B & K | HAMMOND | LEGEND |
|----------|---------|---------|---------|---------|-----------|
| 64317 | GB1 1/2 | T220012 | 110-523 | 875 1/2 | T3000 1/4 |
| 64318 | GB1 3/4 | T220034 | 110-524 | 875 3/4 | T3000 3/4 |

SERVICE & INSTALLATION

PVC Cement, Cleaner & Primer

MARS SERIES **730**

Oatey All Purpose Cement - ABS, PVC, CPVC

Oatey all purpose cement is a heavy bodied, clear cement recommended for use on ABS, PVC or CPVC pipe and fittings. For all pipe schedules, potable water pressure pipe, gas, conduit, drain waste and vent pipe. Flows freely and provides a thick layer of cement on the pipe. Helps to fill gaps in larger diameter pipe and loose fitting joints. Apply at temperature 40°F to 100°F. Exceeds performance requirements of ASTM D-2564, D-2864, D-2235, F-493. Special applicator brush cap for fast and easy installation.



| MARS NO. | DESCRIPTION | MARS PACK |
|----------|--------------|-----------|
| 73161 | 4 oz. clear | 24 |
| 73162 | 8 oz. clear | 24 |
| 73163 | 16 oz. clear | 24 |

Oatey Heavy Duty Cement - PVC

Oatey heavy duty cement is recommended for use on pvc pipe and fittings up to 12" in diameter for schedule 40 and schedule 80 potable water pressure pipe, gas, conduit, drain waste and vent pipe. This heavy bodied cement flows freely and provides a thick layer of cement on the pipe. A special brush cap applicator is provided. Apply at temperatures 40°F to 100°F. This clear cement helps to fill gaps in larger diameter pipe and loose fitting joints. Exceeds ASTM D-2564.



| MARS NO. | DESCRIPTION | MARS PACK |
|----------|--------------|-----------|
| 73165 | 4 oz. clear | 24 |
| 73166 | 8 oz. clear | 24 |
| 73167 | 16 oz. clear | 24 |

Oatey Regular Cement - PVC

Oatey regular cement is recommended for use on PVC pipe and fittings up to 4" for DWV or schedule 40 and up to 2" for schedule 80 potable water pressure pipe, gas, conduit, drain waste and vent pipe. It flows freely and sets up quickly. Apply at temperatures 40°F to 100°F. Exceeds ASTM D-2564. Special brush top applicator.



| MARS NO. | DESCRIPTION | MARS PACK |
|----------|--------------|-----------|
| 73174 | 4 oz. clear | 24 |
| 73175 | 8 oz. clear | 24 |
| 73176 | 16 oz. clear | 24 |
| 73177 | 32 oz. clear | 12 |

Oatey Rain-R-Shine™ Cement - PVC

Oatey Rain-R-Shine™ is a blue colored cement recommended for PVC pipe and fittings up to 6" in diameter. A very fast setting cement formulated for wet conditions and/or when quick pressurization and fast installation is needed. For schedule 40 and schedule 80 potable water pressure pipe, irrigation, gas, conduit, drain waste and vent pipe. This medium bodied cement flows freely and covers with a thicker layer than regular PVC. Apply at temperatures 40°F to 100°F.



| MARS NO. | DESCRIPTION | MARS PACK |
|----------|-------------|-----------|
| 73150 | 4 oz. blue | 24 |
| 73151 | 8 oz. blue | 24 |

Oatey Clear Primer - NSF Listed - PVC, CPVC

Oatey clear primer is a clear aggressive primer for use on PVC and CPVC pipe and fittings for all schedules and diameters. This NSF listed formula removes all surface dirt, grease and grime as well as softens pipe in preparation for solvent cement. Meets ASTM F-656.

| MARS NO. | DESCRIPTION | MARS PACK |
|----------|--------------|-----------|
| 73186 | 16 oz. clear | 24 |

Oatey All Weather Cement-PVC

Oatey all weather cement is recommended for use on PVC pipe and fittings up to 6" in diameter. Formulated for fast initial set up at temperatures down to 10°F, for schedule 40 and schedule 80 potable water pressure pipe, gas, conduit, drain waste and vent pipe. This medium bodied, clear cement flows freely and maintains good gap filling properties. Apply at temperatures 10°F to 100°F. Exceeds ASTM D-2564.



| MARS NO. | DESCRIPTION | MARS PACK |
|----------|--------------|-----------|
| 73156 | 16 oz. clear | 24 |
| 73157 | 32 oz. clear | 12 |

Oatey Purple Primer - PVC, CPVC

Oatey purple primer is recommended for use on PVC and CPVC pipe and fittings, all schedules and diameters. This purple tinted aggressive primer is formulated to remove surface dirt, grease and grime, as well as, soften the pipe surface to allow for a fast, secure and permanent solvent weld. For use in area where code calls for verification that a primer has been used. Exceeds ASTM F-656.



| MARS NO. | DESCRIPTION | MARS PACK |
|----------|---------------|-----------|
| 73178 | 4 oz. purple | 24 |
| 73179 | 8 oz. purple | 24 |
| 73180 | 16 oz. purple | 24 |
| 73185 | 32 oz. purple | 24 |

Oatey All Purpose Cleaner - PVC, CPVC, ABS

Oatey all purpose cleaner is recommended for use on ABS, PVC and CPVC pipe and fittings, all schedules and diameters. This fast acting cleaner removes surface dirt, grease and grime. Flows freely and evaporates quickly. Does not penetrate pipe surface. Apply at temperatures 40°F to 100°F.



| MARS NO. | DESCRIPTION | MARS PACK |
|----------|--------------|-----------|
| 73170 | 8 oz. clear | 24 |
| 73171 | 16 oz. clear | 24 |
| 73172 | 32 oz. clear | 12 |

SERVICE & INSTALLATION

Schedule 40 PVC Fittings & Traps

MARS SERIES **730**

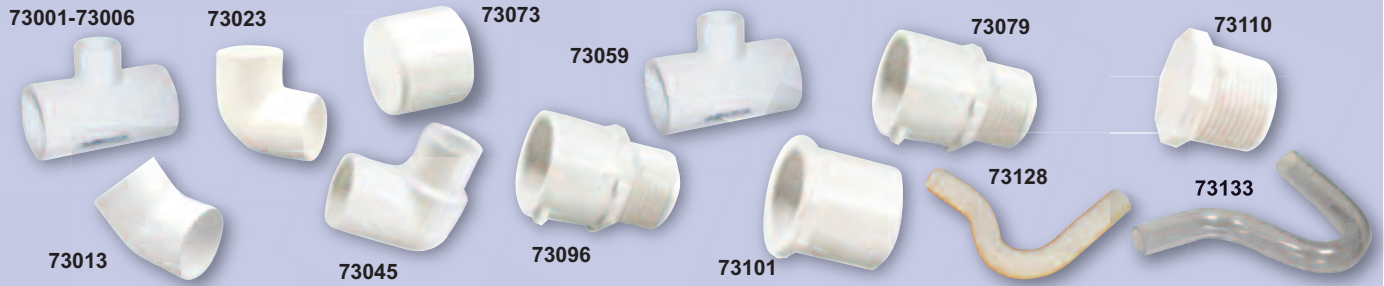

SERVICE & INSTALLATION

Schedule 40 - PVC Couplings

| MARS NO. | DESCRIPTION | MARS PACK |
|----------|------------------|-----------|
| 73001 | 1/2" slip x slip | 100 |
| 73002 | 3/4" slip x slip | 50 |
| 73003 | 1" slip x slip | 50 |
| 73006 | 2" slip x slip | 25 |

Schedule 40 - PVC Elbow 45°

| MARS NO. | DESCRIPTION | MARS PACK |
|----------|------------------|-----------|
| 73013 | 3/4" slip x slip | 50 |

Schedule 40 - PVC Elbow 90°

| MARS NO. | DESCRIPTION | MARS PACK |
|----------|------------------|-----------|
| 73023 | 1/2" slip x slip | 50 |
| 73024 | 3/4" slip x slip | 50 |
| 73025 | 1" slip x slip | 50 |
| 73033 | 3/4" slip x FPT | 50 |

Schedule 40 - PVC Street Elbow 90°

| MARS NO. | DESCRIPTION | MARS PACK |
|----------|------------------|-----------|
| 73045 | 3/4" slip x slip | 50 |
| 73051 | 3/4" slip x MPT | 50 |

Schedule 40 - PVC Caps

| MARS NO. | DESCRIPTION | MARS PACK |
|----------|-------------|-----------|
| 73073 | 3/4" slip | 100 |
| 73075 | 3/4" FPT | 100 |

Schedule 40 - PVC Reducing Adapters

| MARS NO. | DESCRIPTION | MARS PACK |
|----------|----------------------|-----------|
| 73096 | 3/4" MPT x 1/2" slip | 50 |

Schedule 40 - PVC Tees

| MARS NO. | DESCRIPTION | MARS PACK |
|----------|---------------------------|-----------|
| 73059 | 1/2" all slip | 50 |
| 73060 | 3/4" all slip | 50 |
| 73061 | 1" all slip | 50 |
| 73058 | 3/4" slip x FPT x slip | 50 |
| 73066 | 3/4" clean-out tee (2 pk) | 1 |

Schedule 40 - PVC Adapters

| MARS NO. | DESCRIPTION | MARS PACK |
|----------|-----------------|-----------|
| 73079 | 1/2" slip x MPT | 50 |
| 73080 | 3/4" slip x MPT | 50 |
| 73081 | 1" slip x MPT | 50 |
| 73086 | 3/4" slip x FPT | 50 |
| 73087 | 1" slip x FPT | 50 |

Schedule 40 - PVC Reducing Bushings

| MARS NO. | DESCRIPTION | MARS PACK |
|----------|-----------------------|-----------|
| 73101 | 3/4" slip x 1/2" slip | 50 |
| 73102 | 1" slip x 3/4" slip | 50 |

Schedule 40 - PVC Plugs

| MARS NO. | DESCRIPTION | MARS PACK |
|----------|---------------|-----------|
| 73110 | 3/4" MPT plug | 50 |

Schedule 40 - PVC Traps

| MARS NO. | DESCRIPTION | MARS PACK |
|----------|-----------------------------|-----------|
| 73126 | 3/4" P-trap | 1 |
| 73128 | 3/4" mini P-trap | 1 |
| 73129 | 3/4" super P-trap | 1 |
| 73131 | 3/4" R trap | 1 |
| 73133 | 3/4" PVC P-trap Clear | 1 |
| 73134 | 3/4" PVC Mini P-trap Clear | 1 |
| 73135 | 3/4" PVC Super P-trap Clear | 1 |
| 73136 | 3/4" PVC R-trap Clear | 1 |

MARS Nylon & Galvanized Fittings & Nipples

MARS SERIES **730**

Excellent for clear vinyl tubing! All nylon parts are white.

Adapter Nylon Fitting

| MARS NO. | DESCRIPTION | CASE QTY. |
|----------|--------------------------------------|-----------|
| 73201 | Adapter 1/4 barb x 1/4 MPT - 10/pack | 1 |
| 73203 | Adapter 3/8 barb x 3/8 MPT - 10/pack | 1 |
| 73204 | Adapter 3/8 barb x 1/2 MPT - 8/pack | 1 |
| 73206 | Adapter 1/2 barb x 1/2 MPT - 6/pack | 1 |
| 73207 | Adapter 1/2 barb x 3/4 MPT - 4/pack | 1 |
| 73208 | Adapter 5/8 barb x 3/4 MPT - 4/pack | 1 |
| 73209 | Adapter 3/4 barb x 3/4 MPT - 4/pack | 1 |

Elbow Nylon Fitting

| MARS NO. | DESCRIPTION | CASE QTY. |
|----------|-----------------------------------|-----------|
| 73227 | Elbow 3/8 barb x 3/8 MPT - 4/pack | 1 |
| 73229 | Elbow 1/2 barb x 1/2 MPT - 4/pack | 1 |
| 73230 | Elbow 1/2 barb x 3/4 MPT - 4/pack | 1 |
| 73231 | Elbow 5/8 barb x 1/2 MPT - 4/pack | 1 |
| 73232 | Elbow 5/8 barb x 3/4 MPT - 4/pack | 1 |
| 73234 | Elbow 3/4 barb x 3/4 MPT - 4/pack | 1 |
| 73243 | Hose mender 3/8 barb - 5/pack | 1 |
| 73244 | Hose mender 1/2 barb - 4/pack | 1 |
| 73245 | Hose mender 5/8 barb - 4/pack | 1 |

Tee Nylon Fitting

| MARS NO. | DESCRIPTION | CASE QTY. |
|----------|-------------------------------------|-----------|
| 73252 | Tee 3/8 x 3/8 x 3/8 barb - 5/pack | 1 |
| 73253 | Tee 1/2 x 1/2 x 1/2 barb - 4/pack | 1 |
| 73265 | Drain plug 3/4 square head - 5/pack | 1 |
| 73268 | Drain plug 3/4 hex head - 5/pack | 1 |

NIBCO DWV Couplings

| MARS NO. | DESCRIPTION | CONNECTION TYPE | CASE QTY. |
|----------|--------------------------|-----------------|-----------|
| 73269 | 2" coupling | hub x hub | 100 |
| 73270 | 3" coupling | hub x hub | 50 |
| 73271 | 3" X 2" adapter coupling | hub x hub | 50 |

NIBCO DWV Couplings 90° Elbows

| MARS NO. | DESCRIPTION | CONNECTION TYPE | CASE QTY. |
|----------|-------------------------------|-----------------|-----------|
| 73274 | 2" 90° elbow long turn | hub x hub | 50 |
| 73275 | 3" 90° elbow long turn | hub x hub | 25 |
| 73278 | 2" 90° street elbow long turn | spg x hub | 20 |

NIBCO DWV Couplings 45° Elbows

| MARS NO. | DESCRIPTION | CONNECTION TYPE | CASE QTY. |
|----------|---------------------|-----------------|-----------|
| 73280 | 2" 45° elbow | hub x hub | 50 |
| 73281 | 3" 45° elbow | hub x hub | 20 |
| 73282 | 2" 45° street elbow | spg x hub | 50 |



SERVICE & INSTALLATION



The largest selection of motors, components and accessories for the HVAC/R Industry

Condensate Products

MARS SERIES **932 & 934**



SERVICE & INSTALLATION

MARS Condensate Clean-Out Tablets

MARS **TAB™**, condensate and drip pan clean-out tablets, prevent plugging of air conditioning condensate drip pans and drain lines.

MARS **TAB™** does not release any chlorine or other noxious fumes. This economical, simple positive protection can be used on steel, copper, galvanized, painted surfaces and other materials without damage. It is one of the few treatments that will not stain exterior wall when line drains outside.

| MARS NO. | DESCRIPTION | MARS PACK |
|----------|---|-----------|
| 93202 | MARS TAB™ (100 tablets per bottle) | 18 |

MARS One-Shot® Kits - 12 Applications Per Can

MARS One-Shot® is all it takes to instantly clear clogs. MARS One-Shot® drain opener kit instantly clears blockages in all types of fixtures and drains while simultaneously delivering a specially designed enzyme ingredient. This enzyme continues to dissolve grease buildup in the drain long after the initial blockage was cleared. The kit includes: One-Shot drain opener can 7 oz., three foot extension hose and twist fit adapter for ice markers and condensate drain pans.

Benefits & Features:

- Enzyme activated
- No ozone depleting chemicals
- Safe for sewers & septic systems
- Works instantly
- Sanitary and easy to use
- Universal adapter for all types of fixtures
- Seamless aluminum container will not rust
- For drains from 3/8" i.d. to 7/8 i.d.
- Made in the USA
- 12 applications per can

For Use On:

- Condensate pans
- Ice machines
- Bar sinks
- Toilets
- Bathtubs
- Kitchen sinks
- Shower drains
- Floor drains.
- Lavatories

| MARS NO. | DESCRIPTION | MARS PACK |
|----------|-------------------------------------|-----------|
| 93220 | MARS One-Shot® drain opener (7 oz.) | 25 |
| 93221 | MARS One-Shot® refill can (7 oz.) | 36 |

Panseal

Seals and Restores Leaking and Rusted Drain Pans

Panseal is a unique multi-component 2 part epoxy designed to quickly and permanently seal, repair, and restore leaking and corroded drain pans. The product is available in caulk gun cartridges for easy application, gallon size containers for larger surfaces such as cooling towers, patch kits for vertical surfaces and single use 250 gram burst-seal bags. All contain pre-measured amounts of resin and hardener.

- Works in standing water
- Seals leaks immediately
- No surface preparation
- No system down time
- Works on both metal and plastic pans
- 100% solids and entirely free of solvents and volatile organic compounds

| MARS NO. | DESCRIPTION | MARS PACK |
|----------|-------------------|-----------|
| 93526 | Panseal Cartridge | 1 |
| 93527 | Panseal Gallon | 1 |
| 93528 | Panseal Patch | 1 |
| 93579 | Panseal Bag | 1 |
| 93500 | Cartridge Nozzle | 12 |



X-Treme Tape

MARS SERIES **932**

X-Treme Tape

Originally developed for the military, X-Treme Tape is a high quality wrap made from a special silicone compound that adheres to itself when wrapped under tension. 1"W x 10'L roll is packaged in a clamshell and sold in 18 count display cases. Great for emergency repairs of all kinds:

- No Adhesive, bonds to itself
- Cures into a homogeneous mass
- Won't melt up to 500° F
- Remains flexible to -60° F
- Forms a permanent air & water tight seal
- Tensile strength of 600 psi
- Insulates to 8,000 Volts
- Conforms to irregular shapes, stretches to 3x's its length

| MARS NO. | DESCRIPTION | MARS PACK | CASE QTY. |
|----------|--------------|-----------|-----------|
| 93299 | X-Treme tape | 18 | 18 |



93299

SERVICE & INSTALLATION

Circuit Protection Products

MARS SERIES **832**

Circuit Protection

The ZBreaker set from Zebra Instruments protects systems that you install or service from damage caused by shorts, overheating, or wiring problems. A sticker is included so that, if the Tech desires, he can inform his customer where to press the "reset" button and possibly save a midnight service call.

The same circuit breakers now found on many high-end transformers and systems, but at a great price! Kit includes wires and pre-installed terminals that allow you to easily plug it in to the connectors where a plastic-type fuse existed. 3 Amp Size.

| MARS NO. | DESCRIPTION | MARS PACK | CASE QTY. |
|----------|-------------------|-----------|-----------|
| 08574 | ZBreaker Set – 3A | 1 | 24 |

The Short-Pro Tool is a 24 volt system "short-finder". This helps the tech locate a control voltage short. A built-in automatically resetting circuit breaker turns on a bright red LED when tripped. As the tech removes the short, the breaker automatically resets, the LED goes out, and the circuit is restored. Lightweight and compact, with two 18" leads.

| MARS NO. | DESCRIPTION | MARS PACK | CASE QTY. |
|----------|-----------------------|-----------|-----------|
| 08577 | Short Finder Pro Tool | 1 | 24 |



08574

08577

MARS Multimeters

MARS SERIES **657**



MARS Digital Multimeters

MARS digital multimeter #65748 is a compact pocket sized multimeter for measuring DC and AC voltage, DC current, resistance and diode. This economy digital multimeter offers full range overload protection and low battery voltage indication. Unit comes complete with a 9V battery and test leads, and also includes a temperature probe.

SPECIFICATIONS

| FUNCTION | RANGE | RESOLUTION | ACCURACY |
|-----------------|---|----------------|-----------------------------|
| DCV | 200 mV | 100 μ V | $\pm 0.5\%$ of rdg $\pm 2D$ |
| | 2 V | 1 mV | |
| | 20 V | 10 mV | |
| | 200 V | 100 mV | |
| | 1000 V | 1 V | |
| AC (50/60Hz) | 200 V | 100 mV | $\pm 0.8\%$ of rdg $\pm 2D$ |
| | 750 V | 1 V | |
| DCA | 200 μ A | 0.1 μ A | $\pm 1\%$ of rdg $\pm 2D$ |
| | 2000 μ A | 1 μ A | $\pm 1\%$ of rdg $\pm 2D$ |
| | 20 mA | 10 μ A | $\pm 1\%$ of rdg $\pm 2D$ |
| | 200 mA | 100 μ A | $\pm 1.2\%$ of rdg $\pm 2D$ |
| | 10 A | 10 mA | $\pm 2\%$ of rdg $\pm 2D$ |
| OHM | 200 Ω | 100 m Ω | $\pm 0.8\%$ of rdg $\pm 2D$ |
| | 2000 Ω | 1 Ω | $\pm 0.8\%$ of rdg $\pm 2D$ |
| | 20 K Ω | 10 K Ω | $\pm 0.8\%$ of rdg $\pm 2D$ |
| | 200 K Ω | 100 K Ω | $\pm 0.8\%$ of rdg $\pm 2D$ |
| | 2000 K Ω | 1 K Ω | $\pm 1\%$ of rdg $\pm 2D$ |
| Diode Test | Test current 1.6mA: Voltage 2.8V | | |
| Transistor Test | 0-1000 hFE of PNP or NPN transistors | | |
| * Temperature | -4 $^{\circ}$ F to 2498 $^{\circ}$ F -20 $^{\circ}$ C to 1370 $^{\circ}$ C | | |



65748



65749

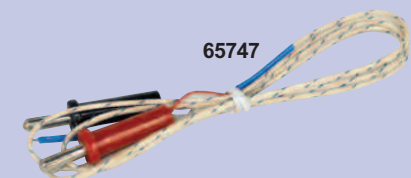

65747

MARS Digital Clamp-On Meters

Features:

- AC Current • DC/AC Voltage • Resistance • Continuity Check
- Continuity check buzzer sounds at approx. 50 ohm max
- Peak Hold & Data Hold • 1.3" (33mm) Clamp Jaw Opening
- Large 0.68", 3-1/2 digit LCD with low battery indicator
- Includes test leads, manual and carry case
- Overload protection provided for all ranges
- Meets IEC 1010 Safety Standard • 9 volt battery included

Range: 0-600 A

Resolution: 1 A

Frequency: 50/60 Hz (+/- 1.5% rdg +/- 4 dgt)
40-400 Hz (+/- 2.5% rdg +/- 4 dgt)

MARS Multimeters

| MARS NO. | DESCRIPTION | MARS PACK |
|----------|-----------------------------------|-----------|
| 65748* | Digital multimeter w/temperature | 1 |
| 65749 | Digital clamp-on meter | 1 |
| 65747 | Replacement temp. leads for 65748 | 1 |

SERVICE & INSTALLATION



MARS Capacitor Tester

Features:

- Easy to use
- 9V battery and test leads included
- Low battery indicator

Specifications:

| Range | Resolution | Accuracy | Test Frequency |
|---------|------------|--------------|----------------|
| 200pF | 0.1pF | ± (0.8% + 7) | 800Hz |
| 2000pF | 1pF | ± (0.8% + 5) | |
| 20nF | 10 pF | | |
| 200nF | 100pF | ± (0.5% + 5) | 80Hz |
| 2 μF | 1000pF | ± (0.8% + 5) | |
| 20 μF | 0.01 μF | | |
| 200 μF | 0.1 μF | ± (2.0% + 5) | 8Hz |
| 2000 μF | 1 μF | ± (2.0% + 5) | |
| 20mF | 10 μF | ± (5.0% + 5) | |

MARS Analog Multimeter

The MARS analog multimeter, MARS #86143, offers fuse and diod protection. This meter is ideal for testing electrical and electronic circuits. This pocket size, lightweight meter features easy to read, two color scale, recessed safety designed input terminals and 12 ranges plus separate off position. Comes complete with test leads, battery, fuse and instruction manual.

Specifications:

- DC voltage: 0-10/50/250/500Vdc
- AC voltage: 0-50/250/500Vdc
- DC current: 0-50/250mAdc
- Battery: 1.5V button cell/1.5V "AA"
- Resistance: 0-10M Ohm (5K Ohm mid-scale)
- Decibels: -20 to +56dB (on AC ranges)

MARS Test Instruments

| MARS NO. | DESCRIPTION | MARS PACK |
|----------|--------------------------------|-----------|
| 65746 | MARS capacitor tester | 1 |
| 86143 | MARS economy analog multimeter | 1 |

Safety Power Adapters

Zebra'Dapter's provide visual indication of voltage levels before damage can occur. One is a fused power tap cordset & the other is a cheater cord used for a safer way to obtain and use 120V power. They are lighted to show the voltage level available, and if the indicator light is ignored, the fused circuit provides a last line of defense to protect you and your customer's equipment. These adapters are significantly a safer way to obtain 120V power.

MARS No. 08566 (Male end) has an in-Line fuse. (Two fuses included). Safer Power from Outlet to test Motors, Components & Systems

MARS No. 08567 (Female end) shows the voltage level at the plug. Used to check 120V power to run vacuum pumps, charging scales, drop lights, etc. lighting

Lighted Plug confirms Power

- No light means no power
- Normal light means 120VAC
- A brilliant light means you accidently hooked it up to 240VAC

| MARS NO. | DESCRIPTION | MARS PACK | CASE QTY. |
|----------|--------------------------------------|-----------|-----------|
| 08566 | Fused Cheater Power Cord (male end) | 1 | 12 |
| 08567 | Fused Power Tap Cordset (female end) | 1 | 12 |



SERVICE & INSTALLATION

Electrical Testers

MARS SERIES **861**



MARS Volt Stick

The Volt Stick is an instrument for safely checking the presence of an AC voltage in cables, wall outlets, fuses, circuit breakers, junction boxes, power tools and appliances. Also, distinguishes between live and neutral wire in single or three phase supplies. No current flow is needed for correct operation of the Volt Stick. When a voltage is detected, a red indicator in the plastic tip of the Volt Stick illuminates. No contact is needed, unit operates at 1/8" distance from device.

Specifications

- Voltage range: 110 to 480 volts AC
- Not sensitive to stray electromagnetic static
- Response time: instantaneous
- Case breakdown: 4000 volts
- Operation temp: 0° to 120°F
- Batteries: two AAA, 1.5 volt alkalines included

| MARS NO. | DESCRIPTION | MARS PACK | CASE QTY. |
|----------|-------------|-----------|-----------|
| 86142 | Volt Stick | 1 | 12 |

MARS Voltage Tester - Carded

The low voltage tester with insulated leads is the fast, easy way to trace and check low voltage AC or DC circuits from 5 to 50 volts. The built-in indicator lamp lights up dim or bright depending on the voltage tested. Comes with pocket clip.

| MARS NO. | DESCRIPTION | MARS PACK |
|----------|--------------------|-----------|
| 86140 | Low voltage tester | 1 |

86142

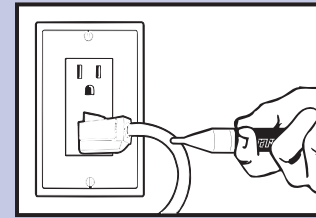
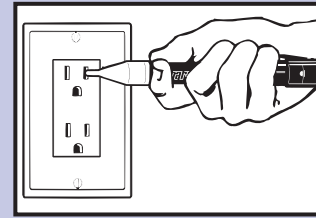

86140

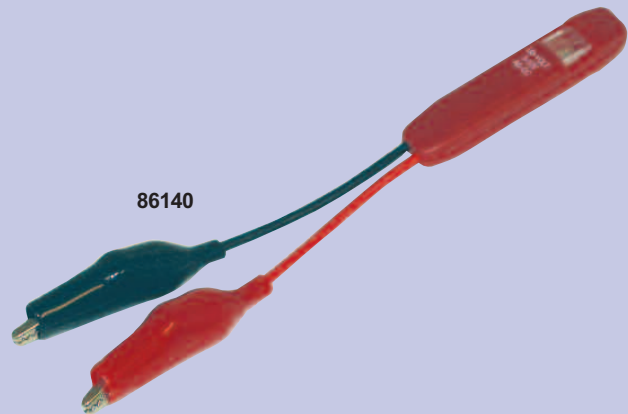



Heat Shrink Tubing & Test Leads

MARS SERIES **861**

MARS Heat Shrink Tubing - Black

The MARS heat shrink tubing shrinks to fit approximately one half its diameter. This polyolefin, flame retardent tubing insulates wiring, repairs cords, covers tool handles, makes strong rope loops and neat ends. It may be easily assembled over irregular shapes. UL and CSA rated. Operating temperature; -55°C to 110°C. Shrink temperature; 120°C to 250°C. Attractively packaged in a dispenser disk for easy dispensing. Simply unwind and cut the amount you need, then wind the unused tubing back into the disk. This clear disk permits visual stock status and keeps tubing clean and protected. Disk packs are center punched for merchandising.

| MARS NO. | TUBE SIZE | EXPAND DIA. | RECOVER DIA. | LENGTH | MARS PACK | CASE QTY. |
|----------|-----------|-------------|--------------|--------|-----------|-----------|
| 86163 | 3/16" | .187 | .093 | 4' | 1 | 10 |
| 86164 | 1/4" | .250 | .125 | 4' | 1 | 10 |
| 86165 | 5/16" | .312 | .156 | 4' | 1 | 10 |
| 86166 | 3/8" | .375 | .187 | 4' | 1 | 10 |
| 86167 | 1/2" | .500 | .250 | 4' | 1 | 10 |
| 86168 | 3/4" | .750 | .375 | 4' | 1 | 10 |

MARS Heat Shrink Tubing Kit And Replacement Packs

| MARS NO. | DESCRIPTION | KIT QTY | MARS PACK | CASE QTY. |
|----------|-------------------------------|---------|-----------|-----------|
| 86170 | Heat shrink tubing kit | | | |
| 86173 | 3/8" exp. i.d. red 4"L 24/bag | 12 | 1 | 1 |

MARS Test Leads - Pkg'd In Poly Bags

| MARS NO. | CLIP SIZE | TYPE | CASE COLORS | WIRE SIZE | L | BAG QTY. |
|----------|-----------|-----------|----------------------------|-----------|-----|----------|
| 86070 | Sm | Alligator | Wht, red, blk, yellow, grn | 18 | 18" | 10 |
| 86071 | Med | Alligator | Red/blk w/boots | 18 | 24" | 2 |
| 86073 | Lg | Alligator | Red/blk w/boots | 14 | 24" | 2 |
| 86074 | Lg | Battery | Red/blk w/boots | 16 | 36" | 2 |

MARS Special Leads - Pkg'd In Poly Bags

| MARS NO. | CLIP SIZE | DESCRIPTION | WIRE SIZE |
|----------|-----------|--|-----------|
| 86075 | Med | 6'-2 wire test cord w/red & blk insul. clips | 16 |
| 86076 | Med | 24" - 3 wire test cord w/fem plug & 3 insul. clips | 16 |

MARS Alligator & Battery Clips - Pkg'd in Zip Lock Bag

| MARS NO. | CLIP SIZE | TYPE | DESCRIPTION | BAG QTY. |
|----------|-----------|-----------|--------------------------------------|----------|
| 86078 | Med | Alligator | Red/blk (1 ea. color boot - 2 clips) | 1 pr. |
| 86079 | Sm | Battery | Red/blk (1 ea. color boot - 2 clips) | 1 pr. |
| 86080 | Med | Battery | Red/blk (1 ea. color boot - 2 clips) | 1 pr. |
| 86081 | Lg | Battery | Red/blk (1 ea. color boot - 2 clips) | 1 pr. |

Zebra Alligator Leads - Clamshell

| MARS NO. | CLIP SIZE | TYPE | DESCRIPTION | BAG QTY. |
|----------|-----------|-----------|--------------------------------|----------|
| 08572 | Sm | Alligator | 5 different colors (up to 6A) | 5 |
| 08573 | Med | Alligator | 8 different colors (up to 15A) | 8 |

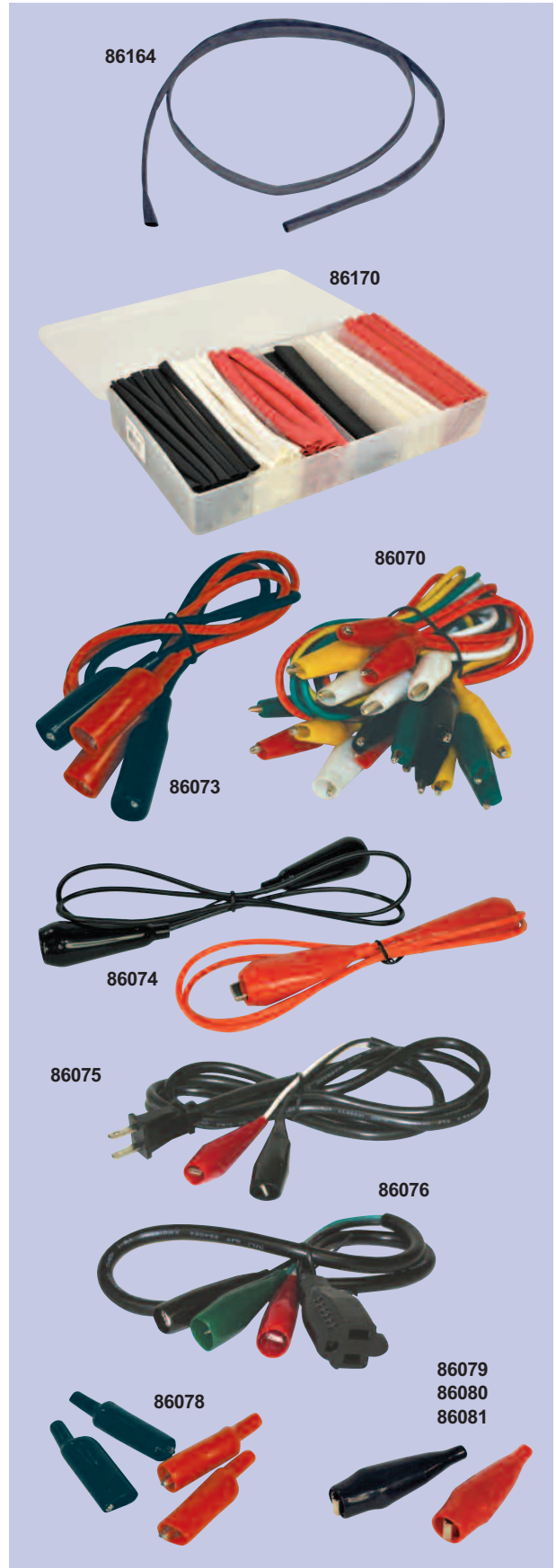

SERVICE & INSTALLATION



The largest selection of motors, components and accessories for the HVAC/R Industry

Batteries

MARS SERIES **794**



SERVICE & INSTALLATION

Eveready Industrial Alkaline - Bulk

Motors & Armatures, Inc., and the Eveready Battery Company offer a complete line of alkaline, general purpose and lantern batteries. These high quality batteries are made in the U.S.A. and are competitively priced.

The Eveready Energizer Industrial Alkaline batteries are environmentally safe. The new black and green shell signifies the "ZMA" (zero mercury added) formulation. This provides a better discharge rate, lower impedance and better low temperature performance than carbon zinc. These ZMA alkaline batteries are also less sensitive to changes in the discharge rate or duty cycle.

| MARS NO. | DESCRIPTION | MARS PACK | CASE QTY. |
|----------|-----------------------|-----------|-----------|
| 79401 | D cell - 1.5V | 12 | 72 |
| 79402 | C cell - 1.5V | 12 | 72 |
| 79403 | AA - 1.5V | 24 | 144 |
| 79404 | AAA - 1.5V | 24 | 144 |
| 79406 | 6V GP lantern battery | 12 | 72 |
| 79405 | 9V | 12 | 72 |
| 79458 | lithium coin - 3V | 6 | 6 |

Eveready Industrial Alkaline - Carded

| MARS NO. | DESCRIPTION | MARS PACK | CASE QTY. |
|----------|-----------------|-----------|-----------|
| 79441 | D cell - 2 pack | 12 | 48 |
| 79442 | C cell - 2 pack | 12 | 48 |
| 79443 | AA - 4 pack | 12 | 48 |
| 79444 | AAA - 4 pack | 12 | 48 |
| 79445 | 9V - 2 pack | 12 | 48 |
| 79457 | AAAA - 2 pack | 6 | 6 |

Bulk Battery Counter Display

Increase your battery sales with the MARS battery counter display. This attractive, eye-catching display incorporates a gravity feed design that conveniently dispenses one battery at a time. This space saver display holds (11) D cells, (14) C cells, (26) AA cells, (36) AAA cells and (14) 9V batteries. Purchase three MARS bulk packs of each alkaline battery size and receive your display FREE! Ask your MARS Representative for details!

| MARS NO. | DESCRIPTION | MARS PACK |
|----------|-------------------------|-----------|
| 79410 | Counter display (empty) | 1 |

Eveready Watch/Calculator Batteries

| MARS NO. | DESCRIPTION | MARS PACK | CASE QTY. |
|----------|---|-----------|-----------|
| 79467 | #386 1.5V repl. SR43W, SP386, GP86, H, S150, SG12 | 6 | 480 |
| 79468 | #393 1.5V repl. SR48, RW48, F, SR754W, 546, 515 | 5 | 100 |
| 79469 | #357 1.5V repl. SR44, RW42, J, SR44W, 541, 547 | 6 | 480 |





Flashlights & Laser Engraving Program

MARS SERIES **792**

MAGLITE® Laser Engraving Program

Motors & Armatures is pleased to offer the Mag-Lite Laser Engraving Program. A Maglite® flashlight can be permanently laser engraved with your company's name or logo. This makes an outstanding gift when you, or your company want to be remembered in the very finest light.

Flashlights are available in our standard blister pack or an attractive presentation gift box for an additional nominal fee per flashlight. The minimum order quantity for the Maglite® Laser Engraving Program is 48 pieces per size.

Engraving Charges

Mini Maglite AA, AAA & Solitaire(50¢ per imprint area)
 Standard Maglite(\$1.00 per imprint area)

***Note: Engraving is not available on Mag's rechargeable flashlight**
Set Up Charge \$50.00 (ea. size)

Artwork Mag requires camera ready artwork. An authorization release to print corporate logos must be obtained prior to engraving.

Lead Time Approximately five days after receipt of artwork and order, paper proof will be sent via fax for approval. If the fax transmission is sufficient for approval, Mag must be notified so that the actual flashlights may be engraved.

Following approval of the sample, the order will be shipped within approximately ten to fifteen working days.

Special Colors A minimum 10,000 unit order and approximately three week leadtime is required on special color orders.

Imprint Area

| | Head | Switch | Knurl | End |
|----------------------|------------|-------------|--------------|-------------|
| Solitaire® | N/A | N/A | 5/16 x 1-1/4 | 5/16 x 1/4 |
| Mini Maglite® AAA | 7/16 x 5/8 | 5/16 x 3/8 | 5/16 x 1-3/4 | 5/16 x 1/2 |
| Mini Maglite® AA | 5/8 x 3/4 | 7/16 x 1/4 | 7/16 x 2-1/8 | 7/16 x 1/2 |
| Standard Maglite® 2C | 1-7/16 x 1 | 3/4 x 1-3/4 | 3/4 x 2-3/4 | 3/4 x 1/2 |
| Standard Maglite® 3C | 1-7/16 x 1 | 3/4 x 1-3/4 | 3/4 x 3-3/4 | 3/4 x 1-3/8 |
| Standard Maglite® 4C | 1-7/16 x 1 | 3/4 x 1-3/4 | 3/4 x 4-3/4 | 3/4 x 2-1/8 |
| Standard Maglite® 5C | 1-7/16 x 1 | 3/4 x 1-3/4 | 3/4 x 5-3/4 | 3/4 x 2-7/8 |
| Standard Maglite® 6C | 1-7/16 x 1 | 3/4 x 1-3/4 | 3/4 x 7-3/4 | 3/4 x 3-5/8 |
| Standard Maglite® 2D | 1-7/16 x 1 | 1 x 1-3/4 | 1 x 2-3/4 | 1 X 1-3/4 |
| Standard Maglite® 3D | 1-7/16 x 1 | 1 x 1-3/4 | 1 x 3-3/4 | 1 X 3 |
| Standard Maglite® 4D | 1-7/16 x 1 | 1 x 1-3/4 | 1 x 4-3/4 | 1 X 4/3/8 |
| Standard Maglite® 5D | 1-7/16 x 1 | 1 x 1-3/4 | 1 x 5-3/4 | 1 X 5-1/2 |

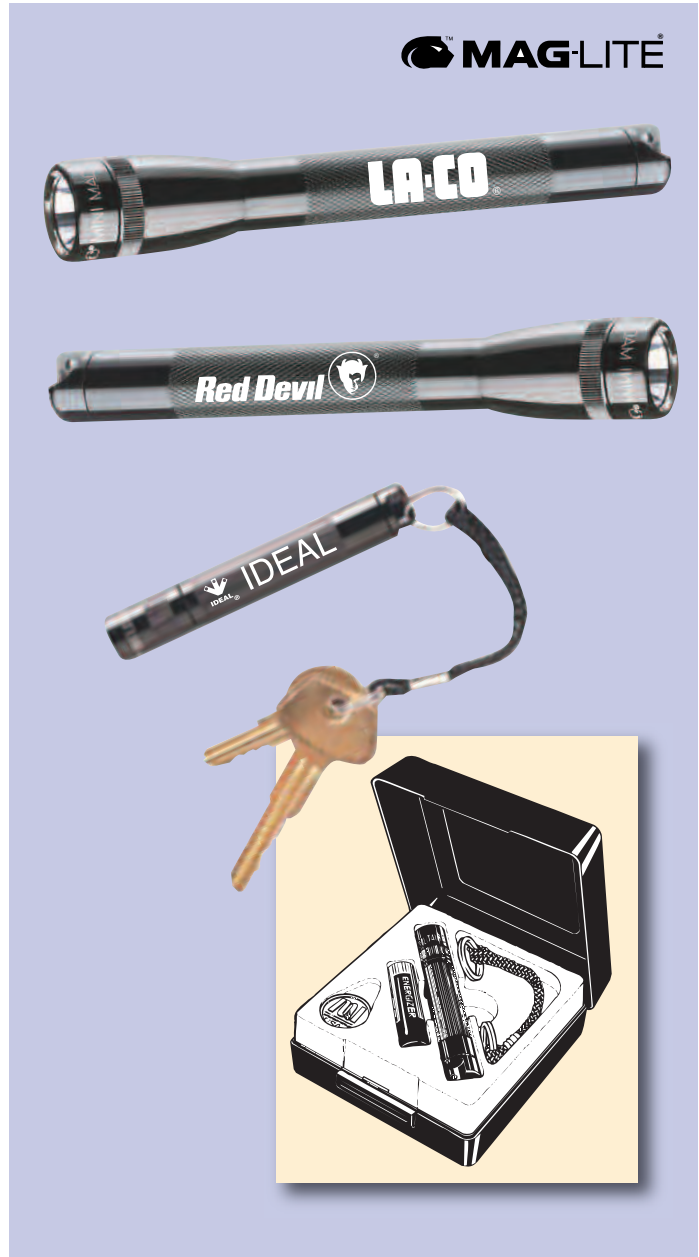

SERVICE & INSTALLATION

Flashlights

MARS SERIES **792**



SERVICE & INSTALLATION

MAGLITE® Flashlights

MARS and Maglite® are committed to providing a full selection of flashlight products designed for use by professionals. Features include anodized aircraft aluminum with knurled grip, o-ring sealed for minimum water resistance and adjustable beams from pinpoint spot to flood. All Maglite flashlights are designed and tested for high impact, precise illumination and longer use. All units have a limited lifetime warranty for repair and replacement of all internal and external components.

| MARS NO. | DESCRIPTION | MAG. NO. | CASE QTY. |
|----------|------------------------------|----------|-----------|
| 79205 | Mini-mag AAA (black) | M3A016 | 12 |
| 79201 | Mini-mag AA (black) | M2A016 | 12 |
| 79230 | Mini-mag AA (blue) | M2A116 | 12 |
| 79252 | Mini-mag AA (camouflage) | M2A026 | 12 |
| 79207 | Mag-light 2C-cell (black) | S2C016 | 12 |
| 79203 | Mag-light 2D-cell (black) | S2D016 | 12 |
| 79204 | Mag-light 3D-cell (black) | S3D016 | 12 |
| 79210 | Mag-light 4D-cell (black) | S4D016 | 12 |
| 79202 | AA combo pack (black) | M2A01C | 12 |
| 79215 | AA mag holster combo (black) | M2A01H | 12 |

MAGLITE® Led Flashlights

| MARS NO. | DESCRIPTION | MAG. NO. | CASE QTY. |
|----------|---------------------------------------|-----------------|-----------|
| 79238 | MiniMaglite 2AA LED (black) | SP221H | 6 |
| 79239 | Maglite 2D-cell LED (black) | SP221H | 6 |
| 79212 | MiniMaglite XL200 3AAA LED (black) | XL200- S3016 | 6 |
| 79240 | Maglite Pro 2AA LED (black) | SP2P01H | 6 |
| 79241 | Maglite Pro + 2AA LED (black) | SP+P01H | 6 |

MAGLITE® Accessories

| MARS NO. | DESCRIPTION | MAG. NO. | CASE QTY. |
|----------|----------------------------|----------|-----------|
| 79222 | AA nylon holster (black) | AM2A056 | 12 |
| 79226 | AA leather holster (black) | AM2A026 | 12 |

MAGLITE® Replacement Lamps

| MARS NO. | DESCRIPTION | MAG. NO. | CASE QTY. |
|----------|--------------------------|----------|-----------|
| 79223 | AA/AAA bulb 2 pack | LM2A001 | 12 |
| 79221 | 2D-2C krypton bulb | LMSA201 | 12 |
| 79220 | 3D-3C krypton bulb | LMSA301 | 12 |
| 79219 | 4D-4C krypton bulb | LMSA401 | 12 |
| 79278 | Halogen Replacement lamp | LR00001 | 12 |

Upgrade LED Kits for MAGLITE®

| MARS NO. | DESCRIPTION | MAG. NO. | CASE QTY. |
|----------|--------------------------------|-------------|-----------|
| 79233 | AA LED Upgrade | LRB-07 | 6 |
| 79232 | AA LED Upgrade II-White | LRB2-07 | 6 |
| 79234 | C & D LED Upgrade | LRB-07-PR | 6 |
| 79227 | AA MiniMaglite IQ Switch | NIQ-07-AA | 6 |
| 79228 | AA MiniMaglite LED Upgrade II | LRB2-07-1W | 6 |
| 79229 | AA MiniMaglite LED II & Switch | NIQ2-07-1WC | 6 |



Lumilite® Lanterns & Industrial Flashlights

Motors & Armatures is pleased to re-introduce Lumilite Flashlights. Our Lumilite product offering provides the wholesaler with high quality lanterns and flashlights at competitive prices and attractive packaging.

The Lumilite 6-Volt Krypton Lanterns are constructed of heavy duty yellow plastic. These lantern flashlights use one 6 volt spring terminal battery. The MARS #79471 is a 6-volt lantern with 4-D battery adapter, 4-D batteries and provided with clamshell packaging.

The 6-Volt Z-Lite Lantern, MARS #79472, features a gray rubberized body. This floatable lantern features an adjustable stand for hands free operation. The unit is provided in clamshell packaging and includes a 4-D battery adapter and 4-D batteries. Unit will operate with a 6-volt spring terminal battery or the 4-D battery adapter.

Lumilite Industrial Flashlights feature a rugged, shockproof polypropylene body. All units come with a super bright krypton bulb and batteries. Yellow safety color. Attractive clamshell packaging. Available in 2AA, 2D, 2D with magnet and 3D sizes.

The Lumilite LED Headlight, MARS #79477, includes an adjustable strap with head cushion and 2 AA batteries. The ratchet headlight rotates up and down for directional beam.

| MARS NO. | DESCRIPTION | MARS PACK | CASE QTY. |
|----------|---|-----------|-----------|
| 79472 | 6-volt Z-Lite lantern w/4D adapter & 4D batteries | 1 | 6 |
| 79474 | 2D flashlight w/batteries | 1 | 12 |
| 79475 | 2D with magnet and batteries | 1 | 12 |
| 79476 | 3D flashlight with batteries | 1 | 12 |

MARS Extendable Magnetic Flashlight

Introducing the MARS Extendable Magnetic Flashlight

The extendable, flexible, lighted, magnetic pickup tool
Tool box utility in your shirt pocket

- Flexible shaft
- Telescopes from 6" to 21"
- 3 Super bright LED's
- Durable machined aluminum body
- Powerful magnetic head and tail
- Uses 4 LR44 batteries (included)

| MARS NO. | DESCRIPTION | MARS PACK |
|----------|--------------------------------|-----------|
| 79479 | Extendable Magnetic Flashlight | |

MARS Accessories

| MARS NO. | DESCRIPTION | MARS PACK |
|----------|---------------------------------|-----------|
| 79460 | LR44, Batteries for 79479, 4 pk | 1 |



SERVICE & INSTALLATION

Electronic P/T Chart

MARS SERIES **657**



Electronic Refrigerant Pressure/Temperature Chart

"Throw away your worn out paper charts"

- Pocket sized
- Includes 61 refrigerants
- Pressure readings in PSI, BAR & MPa
- Temp readings in Fahrenheit and Celsius
- Battery included
- Clamshell packaging

| MARS NO. | MARS PACK |
|----------|-----------|
| 65700 | 1 |



65700

SERVICE & INSTALLATION

Infra-Red Thermometers

MARS SERIES **255**



MARS Infra-Red Laser Thermometer

- Built-in laser pointer
- Data hold & Auto power off
- Temperature Range: -50°C to 350°C (-58°F to 662°F)
- Accuracy: ±2% of reading or ±2°C/±4°F • D:S=8:1
- Complete with 9V battery
- Quickly and easily take the surface temperature of any object. Just point, pull the trigger, and read the temperature on the display.
- °C / °F switchable button
- Backlit LCD display

| MARS NO. | DESCRIPTION | MARS PACK | CASE QTY. |
|----------|----------------------|-----------|-----------|
| 25580 | Infrared thermometer | 1 | 500 |

25580





Scales

MARS SERIES **790**

Pelouze Refrigerant Scales

MARS #79040, the 250 lb platform scale, is ideal for weighing heavy packages and containers. Activated by either hand or foot, the unique "memory lock" holds reading when dial is obscured. The platform and body feature a combination of steel subframe and glass fiber reinforced nylon. Scratch, rust and chemical resistant

The Pelouze electronic scale #79042 features a heavy duty "no-slip" platform, LCD display, and a wall mount control panel. Automatic shut off. Low battery indicator. Displays in 0.2lb/0.1kg increments. All steel construction. Tare functions and remote display head on a 9' cord. Operates on AC adapter (included) or a 9V battery (not included).

MARS #79043 is the ideal electronic scale for heavy duty weighing. This 400 lb x 1/2 lb scale features an easy to read LCD display, automatic shut off, and low battery indicator. The control panel can be wall mounted for easy viewing. Tare functions. Strain gauge weighing operates on AC adapter (included) or one 9V battery (not included).

| MARS NO. | DESCRIPTION | MARS PACK | CASE QTY. |
|----------|------------------------------------|-----------|-----------|
| 79040 | 250 lb. x 1 lb. platform scale | 1 | 1 |
| 79042 | 150 lb. x .2 lb. electronic scale | 1 | 4 |
| 79043 | 400 lb. x 1/2 lb. electronic scale | 1 | 1 |

MARS Hand Held Scale

- Ideal for weighing and checking most gas and refrigerant cylinders
- Easy to use
- Push button for accuracy
- Auto shut off
- Max scale up to 55 lbs
- 9V battery included
- Accuracy up to +/- 2%
- LBS/KGS switch

| MARS NO. | DESCRIPTION | MARS PACK |
|----------|-------------------------|-----------|
| 79039 | Digital hand held scale | 1 |



SERVICE & INSTALLATION



Refrigerant I.D. Labels

MARS SERIES **790**

MARS Refrigerant I.D. Labels

MARS refrigerant I.D. labels are color coded to conform to each particular refrigerant. Each label specifies the type of refrigerant, the chemical name, the UN # and a space for the name and address of the cylinder owner. These self-adhering labels are 4 1/2" x 3 1/2", except for MARS #79528, Refrigerant Evacuation Certificate, which is 7 1/2" x 4 1/2".

| MARS NO. | DESCRIPTION | MARS PACK |
|----------|---|-----------|
| 79522 | R-22 Refrigerant I.D. Labels (10 pk) | 1 |
| 79523 | R-134A Refrigerant I.D. Labels (10 pk) | 1 |
| 79516 | SUVA® HP62 Refrig. Labels (10 pk) | 1 |
| 79511 | R-407A Refrigerant I.D. Labels (10 pk) | 1 |
| 79512 | R-407C Refrigerant I.D. Labels (10 pk) | 1 |
| 79536 | GENETRON® AZ-20 Refrig. Labels (10 pk) | 1 |
| 79526 | R-421A Refrigerant I.D. Labels (10 pk) | 1 |
| 79525 | R-422B Refrigerant I.D. Labels (10 pk) | 1 |
| 79527 | R-422D Refrigerant I.D. Labels (10 pk) | 1 |
| 79506 | R-438A Refrigerant I.D. Labels (10 pk) | 1 |
| 79513 | R-507 Refrigerant I.D. Labels (10 pk) | 1 |
| 79528 | Refrigerant evacuation certification (5 pk) | 1 |
| 79514 | R-508B SUVA® refig. Label (10 pk) | 1 |

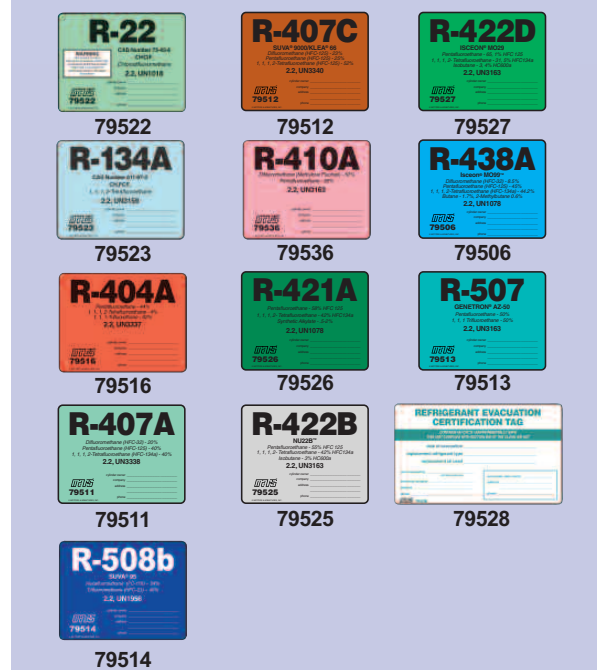

The largest selection of motors, components and accessories for the HVAC/R Industry

Thermometers

MARS SERIES **255**



MARS Pocket Bi-Metal Dial Thermometers

MARS pocket dial thermometers consist of stainless steel cases with 5" stem. Thermometers are completely waterproof. Units are protected by flexible plastic case with clip. They can be recalibrated for accuracy.

| MARS NO. | DESCRIPTION | MARS PACK | CASE QTY. |
|----------|-------------------------------------|-----------|-----------|
| 25510 | 1" dial -40° F to 160°F thermometer | 1 | 12 |
| 25520 | 1" dial 0° F to 220°F thermometer | 1 | 12 |



MARS Pocket Digital Thermometers

MARS #25531 deluxe digital pocket thermometer features an on/off switch and a data hold button. The easy to read LCD digits can be displayed in both fahrenheit and centigrade. The new slim design fits nicely in your pocket. Pocket clip and battery are included. $\pm 2^\circ$ accuracy. Uses MARS #79467 replacement battery. Water and drop resistant. Auto power off is also a new feature.

The multi feature round digital thermometer features an "on/off" switch and "clear" button. This pocket thermometer displays both fahrenheit and centigrade. A "min/max" button is also featured and a clear protective plastic sheath with pocket clip is included.

| MARS NO. | DESCRIPTION | MARS PACK | CASE QTY. |
|----------|--|-----------|-----------|
| 25531 | Deluxe digital pocket, -40°F to 300°F, -50°C to +150°C | 1 | 12 |
| 79467 | #386 replacement battery for #25531 | 6 | 480 |
| 79468 | #393 replacement battery for #25532 | 6 | 48 |

Deltatrak Environmental Temperature Recorders

The 5 day **disposable** temperature recorder is an inexpensive, one-time use temperature recorder indispensable for HVAC/R uses. It gives an accurate 5-day strip chart recording of a wide ambient temperature range. It can be easily changed on the job! After use, recycle it. Drop in any mailbox using the postage paid return label.

Single-Use Deltatrak features & benefits:

- Inexpensive (cheaper than renting a recorder)
- Factory calibrated, no need for field calibration
- Security sealed, tamper proof and built rugged
- Ideal monitor/verification of performance of HVAC or refrigeration units, after installation or repair
- Worry-free from loss or breakage of an expensive recorder
- Simple to understand & use
- The DeltaTRAK cost can easily be charged to the job at a profit
- Ideal to use when a number of jobs are in progress and several recorders become necessary
- Never need to repair since they are used only once
- Ideal for the occasional user of a recorder
- Displays both Fahrenheit and Centigrade.

| MARS NO. | DESCRIPTION | MARS PACK | CASE QTY. |
|----------|------------------------|-----------|-----------|
| 25563 | 5 day disposable model | 1 | 20 |

MARS Refrigerator/Oven Thermometers

Horizontal refrigerator/freezer thermometer is most often specified for commercial applications. Hang, stand, or permanent mount. Stainless steel refrigerator or oven models utilize 2" easy to read dial. Hang or stand.

| MARS NO. | DESCRIPTION | MARS PACK | CASE QTY. |
|----------|--|-----------|-----------|
| 25540 | Horizontal glass tube refrig. -40°F to 80°F, -40°C + 0° to +26°C | 1 | 6 |
| 25542 | Stainless steel refrigerator -20°F to 80°F, -29°C to +26°C | 1 | 6 |

Visual Heat Exchanger Inspection System

The Visible Defects Heat Exchanger Inspection System is a tool that provides service technicians with an accurate, cost effective, and non-destructive means for evaluating heat exchangers in fuel fired furnaces. Cracked heat exchangers emit carbon monoxide gas into the living space of the dwelling which can result in sickness or death.

To perform the test, the technician simply inserts the brass spray nozzle fully into the air side of the heat exchanger and slowly pulls the nozzle out while spraying the patent pending green fluorescent dye and coating the inside of the heat exchanger. Next, the technician uses the black UV light to illuminate any dye that breaches the wall (via a crack) between the air-side and combustion-side of the heat exchanger. The test is fast, easy, and very effective. The real value lies in the fact that the service technician can easily show the furnace owner the existing problem.

The kit includes:

- Instructional Video
- Patent Pending Spray Applicator w/2 Nozzles
- Super Bright LED UV Light
- UV Blocking Safety Glasses
- Acrylic Inspection Mirror
- 2 Gallons of Crack Finder Dye
- 1 year Warranty

| MARS NO. | DESCRIPTION | MARS PACK | CASE QTY. |
|----------|----------------------------|-----------|-----------|
| 93800 | VD Detection kit | 1 | 1 |
| 93816 | Dye-Gallon Refill | 1 | 4 |
| 93817 | 22" Replacement Nozzle Set | 1 | 1 |
| 93818 | Replacement Spray Bottle | 1 | 1 |



93800

Welding/Brazing/Cutting/Heating Tools

MARS SERIES **256**



SERVICE & INSTALLATION

Oxy Fuel Outfits

These light/medium duty outfits are designed for a variety of HVAC, Plumbing, Refrigeration and general maintenance work. They include cylinders and a tough, lightweight polypropylene carrier. All components are UL listed.

- Torch Handles are machined from high quality forged brass and feature a Tube-in-a-Tube design for high handle strength.
- Oxygen and acetylene regulators are compact rear entry inlet design for better balance and come with 2" easy view gauges.
- Check valves prevent reverse flow of gases which can cause dangerous mixtures. • All cylinders are shipped empty.

MARS #26901

Kit Includes:

- | | |
|---|---------------------------------|
| 1 welding/brazing tip | 1 single flint striker |
| 1 multi-flame rosebud tip | 1 pair torch end check valves |
| 1 torch handle | 1 plastic carrier |
| 1 acetylene regulator (rear mount) | 1 "type 40" oxygen cylinder |
| 1 oxygen regulator (rear mount) | 1 "MC" acetylene cylinder |
| 1 1/2" grade "R" welding & soldering hose | 1 eye cup style welding goggles |

MARS #26902

Kit includes:

- All items included with 26901
1 cutting attachment

Welding/Brazing/Heating Tips

MARS welding & brazing tips have red copper tip ends and are ideal for soldering, brazing, heating and hardfacing, etc. Interchangeable with all major manufacturers.

| MARS NO. | METAL THICKNESS | DRILL SIZE | OXYGEN (PSIG) | ACETYLENE (PSIG) | ACETYLENE (SCFH) |
|----------|-----------------|------------|---------------|------------------|------------------|
| 26904 | 3/64" – 3/32" | 60(.040) | 3/5 | 3/5 | 3/6 |
| 26905 | 1/16" – 1/8" | 56(.046) | 3/5 | 3/5 | 5/10 |
| 26906 | 1/8" – 3/16" | 53(.060) | 4/7 | 3/6 | 8/18 |
| 26907 | 3/16 – 1/4" | 49(.0730) | 5/10 | 4/7 | 10/25 |

MARS Rosebud tips are multi-flamed tips designed for heating in confined areas.

| MARS NO. | OXYGEN (PSIG) | BRAZING CAPACITY FOR COPPER |
|----------|---------------|-----------------------------|
| 26903 | 15 | 1/2" – 6" |

Air Acetylene Swirl Flame Tips

MARS swirl flame tips are constructed with replaceable stainless steel tips ends, an industry exclusive, for easy repair and maintenance. These tips produce a very hot flame that expands the heat zone providing maximum combustion efficiency for fast soldering and brazing. All swirl flame tips are interchangeable with all major manufacturers.

| MARS NO. | COPPER TUBING CAPACITY SOFT SOLDER | SILVER SOLDER |
|----------|------------------------------------|---------------|
| 26911 | 1/4"-1" | 1/8"-1/2" |
| 26912 | 3/4"-1 1/2" | 1/4"-3/4" |
| 26913 | 1"-2" | 1/2"-1" |

26902

26901

26903

26904-26907

26911

26912

26913

CROSS REFERENCE

| MARS # | TurboTorch | Uniweld | Victor | GOSS | Prest-O-Lite | Sure Fire |
|--------|------------|------------|--------|----------|--------------|-----------|
| 26902 | | K46NP-T | | | | |
| 26901 | | K23C-T | | | | |
| 26903 | VMA-1-15 | TYPE17 #30 | | | | |
| 26904 | 193-02P | TYPE 17#1 | 1-W-J | | | |
| 26905 | 194-02P | TYPE17#2 | 2-W-J | | | |
| 26906 | 195-02P | TYPE17#3 | 3-W-J | | | |
| 26907 | 196-02P | TYPE17#4 | 4-W-J | | | |
| 26908 | | TYPE17#5 | 5-W-J | | | |
| 26909 | | TYPE17#6 | 6-W-J | | | |
| 26911 | A-3 | A-3 | 3 | QD-SJ-3A | | |
| 26912 | A-5 | A-5 | 5 | QD-SJ-4A | AA1301 | |
| 26913 | A-8 | A-8 | | QD-SJ-5A | | |

MARS hardware and fasteners are competitively priced and exhibit superior quality required by the HVACR contractor and tradesman.

All fasteners are available in two different package configurations. Both configurations enhance contractor self service and encourage impulse purchases.

Round Head Combo Slotted/Phillips Machine Screws - Steel Zinc Plated

| MARS NO. | MINI-PAK QTY. | DESCRIPTION |
|----------|---------------|----------------|
| 79808 | 25 | 1/4-20 x 3/4 |
| 79809 | 25 | 1/4-20 x 1 |
| 79811 | 25 | 1/4-20 x 1 1/2 |

Hexagon Nuts - Steel Zinc Plated

| MARS NO. | MINI-PAK QTY. | DESCRIPTION | MARS NO. | SUPER-PAK QTY. |
|----------|---------------|---------------------|----------|----------------|
| 79836 | 25 | 6-32 for 1/8 bolt | | |
| 79837 | 25 | 8-32 for 5/32 bolt | | |
| 79838 | 25 | 1/4-20 for 1/4 bolt | 80038 | 100 |
| 79839 | 25 | 3/8-16 for 3/8 bolt | 80039 | 100 |

Pan Hd Combo Slotted/Phillips Tap Screws - Zinc Chromate

| MARS NO. | MINI-PAK QTY. | DESCRIPTION |
|----------|---------------|-------------|
| 79860 | 25 | 12 x 1 |

Indented Hex Washer Hd Slotted Drill Screws - Zinc Plated

| MARS NO. | MINI-PAK QTY. | DESCRIPTION | MARS NO. | SUPER-PAK QTY. |
|----------|---------------|----------------------|----------|----------------|
| 79871 | 25 | 8 x 1/2 x 1/4 hd | 80071 | 100 |
| 79872 | 25 | 10 x 3/4 x 5/16 hd | 80072 | 100 |
| 79873 | 25 | 10 x 1 x 5/16 hd | 80073 | 100 |
| 79874 | 25 | 10 x 1 1/4 x 5/16 hd | | |
| 79875 | 25 | 10 x 1 1/2 x 5/16 hd | | |
| 79876 | 25 | 10 x 2 x 5/16 hd | | |

Indented Hex Washer Hd Self Drill Screw - Steel Zinc Chrom.

| MARS NO. | MINI-PAK QTY. | DESCRIPTION | MARS NO. | SUPER-PAK QTY. |
|----------|---------------|--------------------|----------|----------------|
| 79887 | 25 | 8 x 1/2 x 1/4 hd | 80087 | 100 |
| | | 8 x 3/4 x 1/4 hd | 80088 | 100 |
| 79889 | 25 | 10 x 1/2 x 5/16 hd | 80089 | 100 |
| 79890 | 25 | 10 x 3/4 x 5/16 hd | 80090 | 100 |
| 79891 | 25 | 10 x 1 x 5/16 hd | 80091 | 100 |



79808

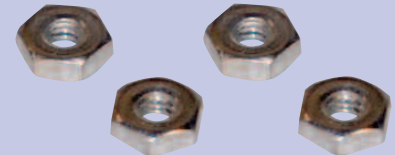

79836



79860

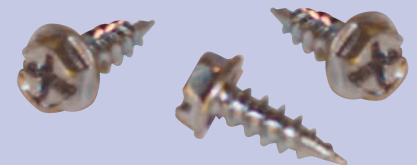

79871



79887

MARS Hardware

MARS SERIES **798**



Drywall Screw - Bugle Hd Phillips 20 Ga. Max Steel Stud, Blk

| MARS NO. | MINI-PAK QTY. | DESCRIPTION |
|----------|---------------|-------------|
| 79904 | 25 | 6 x 1 5/8 |
| 79905 | 25 | 6 x 2 |

Fender Washers - Steel Zinc Chromate

| MARS NO. | MINI-PAK QTY. | DESCRIPTION | MARS NO. | SUPER-PAK QTY. |
|----------|---------------|--------------------------|----------|----------------|
| 79916 | 25 | 1/4 x 1 for 1/4 bolt | | |
| 79917 | 25 | 1/4 x 1 1/4 for 1/4 bolt | 80117 | 100 |
| 79918 | 25 | 3/8 x 1 1/4 for 3/8 bolt | 80118 | 100 |
| 79919 | 25 | 3/8 x 1 1/2 for 3/8 bolt | | |

Flat Wrought Washers - Steel Zinc Chromate

| MARS NO. | MINI-PAK QTY. | DESCRIPTION |
|----------|---------------|----------------------|
| 79939 | 25 | 1/4 USS for 1/4 bolt |
| 79940 | 25 | 3/8 USS for 3/8 bolt |

Flat SAE Washers - Steel Zinc Chromate

| MARS NO. | MINI-PAK QTY. | DESCRIPTION | MARS NO. | SUPER-PAK QTY. |
|----------|---------------|----------------------|----------|----------------|
| 79930 | 25 | 10 SAE for 3/16 bolt | | |
| 79931 | 25 | 1/4 SAE for 1/4 bolt | 80131 | 100 |
| 79932 | 25 | 3/8 SAE for 3/8 bolt | 80132 | 100 |

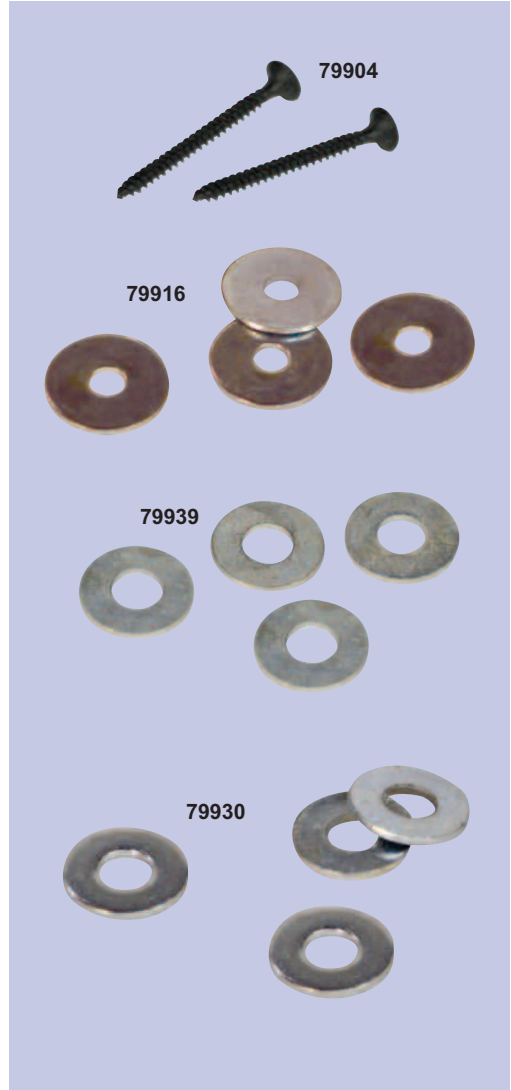

SERVICE & INSTALLATION



Spring Wing Toggle Bolts - Zinc Plated - Mushroom Head

| MARS NO. | MINI-PAK QTY. | DESCRIPTION |
|----------|---------------|-------------|
| 79953 | 10 | 1/4-20 x 4 |

MARS Plastic Anchor Kits

| MARS NO. | DESCRIPTION | MARS PACK | CASE QTY. |
|----------|--|-----------|-----------|
| 79974 | Plastic conical anchor with pan head combo kit contents: (100) 1/4 plastic anchors, (100) #10 x 1 pan combo hd screw zinc, (1) 1/4 x4 masonry drill | 1 | 200 |
| 79975 | Plastic conical anchor with hex washer head kit contents: 100) 1/4 plastic anchors, (100) #10 x 1 hex washer hd slot screws zinc, (1) 1/4 x4 masonry drill | 1 | 200 |
| 79976 | Plastic screw-in anchor with pan head combo kit contents: (50) plastic screw-in anchors, (50) #8 1 1/2 pan combo hd screw zinc | 1 | 100 |
| 79977 | Metal screw-in anchor with pan head combo kit contents: (50) metal screw-in anchors, (50) #8 1 1/2 pan combo hd screws zinc | 1 | 100 |

Green Grounding Screws & Box Clips

| MARS NO. | MINI-PAK QTY. | DESCRIPTION | MARS PACK |
|----------|---------------|---|-----------|
| 80160 | 25 | 10-32 x 3/8" slotted hex head washer type | 1 |

Plastic Anchor Kits

Plastic anchors are designed to be used with either woodscrews or sheet metal screws. They are recommended for quick, easy fastening of fixtures such as thermostats, thermostat guards, shelf brackets, cabinets, mirrors, pictures, etc. All plastic anchor kits include plastic anchor, screws and carbide masonry drill bit. All kits are packaged in a durable, see-through reclosable plastic storage case.

| MARS NO. | DESCRIPTION | CASE QTY. |
|----------|--|-----------|
| 80168 | 8-10 x 7/8" plastic anchor kit with slotted pan screw, contains: (100) 8-10 conical anchors, (100) 8 x 1" slotted pan screw, (1) 3/16" x 4" carbide masonry drill bit | 1 |
| 80169 | 8-10 x 7/8" plastic anchor kit with pan combo screw, contains: (100) conical anchors, (100) 8 x 1" phillips/slotted pan screw, (1) 3/16" x 4" carbide masonry drill bit | 1 |
| 80171 | 10-12 x 1" plastic anchor kit with slotted pan screw, contains: (100) 1/4" conical anchors, (100) 10 x 1 1/4" phillips, slotted pan screw, (1) 1/4" x 4" carbide masonry drill bit | 1 |
| 80172 | 10-12 x 1" plastic anchor kit with hex washer slotted screw, contains: (100) 1/4" conical anchors, (100) 10 x 1 1/4" hex washer slotted screw, (1) 1/4" x 4" carbide masonry drill bit | 1 |
| 80174 | 14-16 x 1 3/8" plastic anchor kit with slotted pan screw, contains: (50) conical anchors, (50) 14 x 1" slotted pan screw, (1) 5/16" x 4" carbide masonry drill bit | 1 |

Hollow Wall Anchor Kits

| MARS NO. | DESCRIPTION | CASE QTY. |
|----------|--|-----------|
| 80179 | #6 hollow wall anchor kit, contains: (50) #6 hollow wall plastic anchors (50) 6 x 1" slotted phillips pan screw | 1 |
| 80180 | #8 hollow wall anchor kit, contains: (50) #8 self drill hollow wall plastic anchors (50) 8 x 1 1/4" slotted phillips pan screw | 1 |



SERVICE & INSTALLATION

MARS Brushes

MARS SERIES **788**



SERVICE & INSTALLATION

Tube Fitting Brushes - Heavy Duty Stainless Steel

| MARS NO. | DESCRIPTION | | MARS PACK |
|----------|-------------|---------------------------------|-----------|
| 78801 | 1/4" OD | 1/8" ID fitting brush (2 bag) | 6 |
| 78802 | 3/8" OD | 1/4" ID fitting brush (2 bag) | 6 |
| 78803 | 1/2" OD | 3/8" ID fitting brush (2 bag) | 6 |
| 78804 | 5/8" OD | 1/2" ID fitting brush (2 bag) | 6 |
| 78805 | 3/4" OD | 5/8" ID fitting brush (2 bag) | 6 |
| 78806 | 7/8" OD | 3/4" ID fitting brush (2 bag) | 6 |
| 78808 | 1 1/8" OD | 1" ID fitting brush (2 bag) | 6 |
| 78809 | 1 3/8" OD | 1 1/4" ID fitting brush (2 bag) | 3 |

Tube Cleaning Brushes

| MARS NO. | DESCRIPTION | MARS PACK |
|----------|---------------------------------------|-----------|
| 78818 | 3/8" x 3/4" OD refrig. 4-1 brush tool | 12 |
| 78819 | 1/2" x 3/4" OD refrig. 4-1 brush tool | 12 |
| 78820 | 5/8" x 7/8" OD refrig. 4-1 brush tool | 12 |

Refrigeration Coil Brush

| MARS NO. | DESCRIPTION | MARS PACK |
|----------|---|-----------|
| 78828 | 5/8" to 1 5/8" fiber condenser cleaner 32" | 12 |
| 78829 | 5/8" to 1 5/8" tapered condenser cleaner 29" | 12 |
| 78830 | 3/4" to 1 5/8" tapered refrig. coil brush 28" | 12 |

Fin And Coil Brushes

| MARS NO. | DESCRIPTION | MARS PACK |
|----------|--|-----------|
| 78833 | Fin and coil whiskbrush, 6 3/4" | 12 |
| 78834 | Fin and comb scraping tool, adjustable | 12 |
| 78835 | 6-in-one fin comb (8, 9, 10, 12, 14, 15 fins per inch) | 12 |

Acid And Flux Brushes

| MARS NO. | DESCRIPTION | MARS PACK |
|----------|-----------------------------|-----------|
| 78839 | #1 acid brush 1/4" - 48 box | 1 |
| 78840 | #2 acid brush 3/8" - 48 box | 1 |
| 78841 | #1 acid brush 1/4" - 10 bag | 10 |
| 78842 | #2 acid brush 3/8" - 6 bag | 10 |





Flue And Boiler Brushes

| MARS NO. | DESCRIPTION | MARS PACK |
|----------|---|-----------|
| 78945 | 1-1/2" x 1-1/8", 30" OAL, Specialty Boiler Brushes - WEIL MCLAIN | 6 |
| 78946 | 1/2" x 1", 27" OAL, Flat, Specialty Boiler Brushes - COLUMBIA | 6 |
| 78947 | 2-1/4", 20" OAL, Tapered, Specialty Boiler Brushes - SLANT FIN | 6 |
| 78948 | 1-1/2" x 1-1/8" x 36" OAL, HD, Gold Series Original, Specialty Boiler Brushes - WEIL MCLAIN | 6 |
| 78949 | 1/2" - 1" Taper, 30" OAL, Horsehair, Specialty Boiler Brushes - TAPERED | 6 |
| 78950 | 1-7/8" - 1-1/8" Taper, 42" OAL, Horsehair, Specialty Boiler Brushes - TAPERED | 6 |
| 78951 | 1" Dia., 16" OAL, Horsehair Brushes for Boilers Burners, Radiators, Flues, Vents and Nozzles | 6 |
| 78952 | 2" Dia., 27" OAL, Horsehair Brushes for Boilers Burners, Radiators, Flues, Vents and Nozzles | 6 |
| 78953 | 3" Dia., 27" OAL, Tampico/Fiber Tube Brushes for Boilers Burners, Radiators, Flues, Vents and Nozzles | 6 |
| 78954 | 2" Dia., 42" OAL, Horsehair Brushes for Boilers Burners, Radiators, Flues, Vents and Nozzles | 6 |
| 78955 | 3" Dia., 42" OAL, Tampico/Fiber Tube Brushes for Boilers Burners, Radiators, Flues, Vents and Nozzles | 6 |

These brushes have 3" brush lengths and 1/2" or 3/4" loop handles for easy hanging.

| MARS NO. | DESCRIPTION | MARS PACK |
|----------|--|-----------|
| 78956 | 1/2" Dia., 18" OAL, Stainless Steel Fine-Wire Single Spiral Brushes for Small Boilers, Burners, Nozzles & Fans | 12 |
| 78957 | 3/4" Dia., 24" OAL, Stainless Steel Fine-Wire Single Spiral Brushes for Small Boilers, Burners, Nozzles & Fans | 12 |
| 78958 | 1-1/2" Dia., 42" OAL, Carbon Steel Fine-Wire Single Spiral Brushes for Small Boilers, Burners, Nozzles & Fans | 6 |

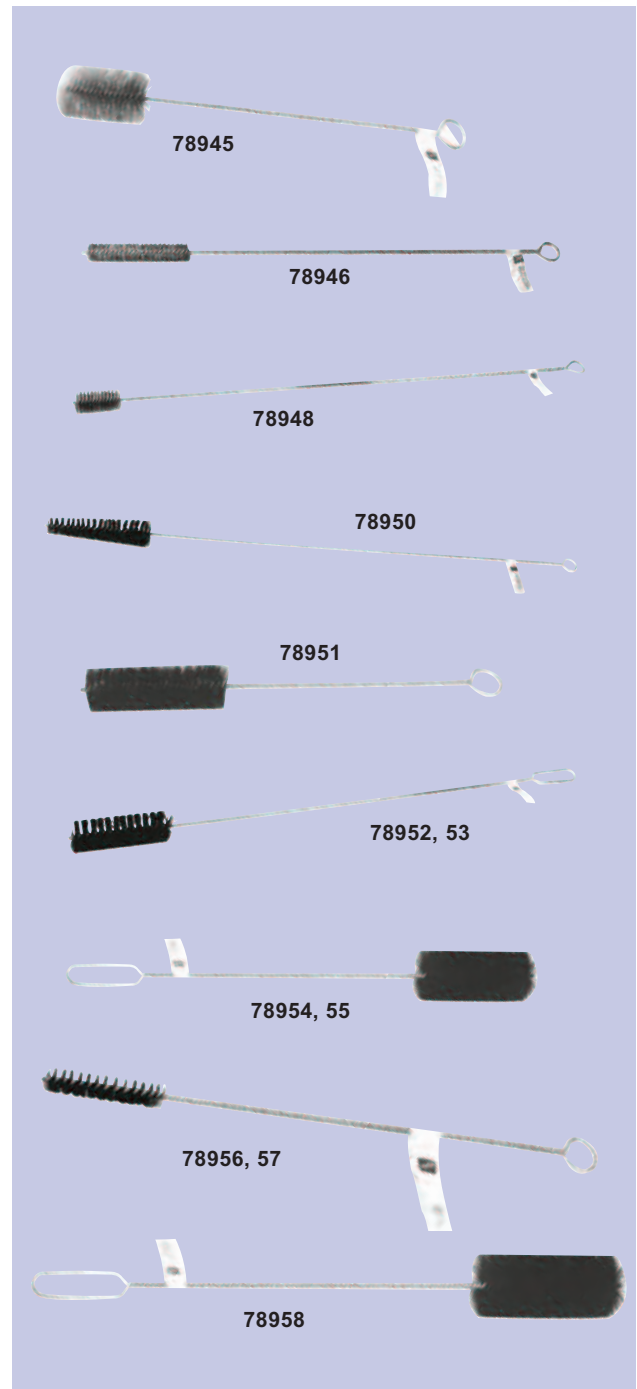

MARS Brushes

MARS SERIES **788**



SERVICE & INSTALLATION

Applicator Brushes, Natural Bristle

| MARS NO. | DESCRIPTION | MARS PACK |
|----------|--|-----------|
| 78902 | 1 1/2" economy paint brush-wood handle | 36 |
| 78903 | 2" economy paint brush-wood handle | 24 |
| 78904 | 2 1/2" economy paint brush-wood handle | 12 |
| 78905 | 3" economy paint brush-wood handle | 12 |
| 78906 | 4" economy paint brush-wood handle | 12 |

Utility And Appliance Brushes

| MARS NO. | DESCRIPTION | MARS PACK |
|----------|---|-----------|
| 78910 | Plastic handle stainless brush, 3 x 7 rows, 3 pk. | 12 |
| 78911 | Wood handle stainless brush, 2 x 9 rows, 3 pk. | 12 |
| 78912 | 1 1/16" dia. parts cleaning brush | 6 |
| 78913 | Bent handle carbon scratch brush, 4 x 18 rows | 12 |
| 78915 | Shoe handle carbon scratch brush, 4 x 16 rows | 12 |

Abrasive Cloth And Pads

| MARS NO. | DESCRIPTION | MARS PACK |
|----------|--|-----------|
| 78920 | 1 1/2" x 5 yds. open coat white cloth | 24 |
| 78921 | 1 1/2" x 10 yds. open coat white cloth | 24 |
| 78922 | 1 1/2" x 25 yds. open coat white cloth | 20 |
| 78923 | 1 1/2" x 5 yds. open nylon mesh cloth | 24 |
| 78924 | 1 1/2" x 10 yds. open nylon mesh cloth | 24 |
| 78925 | 1 1/2" x 25 yds. open nylon mesh cloth | 20 |
| 78926 | 4" x 6" med. nylon abrasive pad, maroon, 10 pk | 1 |
| 78928 | 1 1/2" x 10 yds. competitive abrasive cloth | 1 |
| 78918 | 1 1/2" x 25 yds. competitive abrasive cloth | 1 |

Accessories

| MARS NO. | DESCRIPTION | MARS PACK |
|----------|---|-----------|
| 78930 | Solder/braze heat shield, 9" x 12" x 1/2" temperatures exceeding 2500°F | 10 |
| 78931 | Solder heat shield, 9" x 12" temperatures up to 2500°F | 10 |
| 78932 | Heavy duty deburring tool, 3 blades | 10 |
| 78933 | Deburring tool replacement blades, 5 pack | 10 |
| 78935 | Heavy duty plastic stackable utility box, 12"x6"x6" | 12 |





PowerCrown Outward Clinch Tackers

Model PC4000-OC1 & PC4000-OC2 Features:

- Easy squeeze design
- Compact, lightweight
- Convenient bottom load
- Unique design turns staple legs outward
- For pipe wrap, duct board and corrugated

| MARS NO. | DESCRIPTION | MFG. NO. | CASE QTY |
|----------|------------------------|----------------|----------|
| 73349 | Outward Clinch Tacker | T6-80C2 | 12 |
| 73346 | 1/4" Staples / 5M Box | STCR5019 1/4" | 20 |
| 73347 | 3/8" Staples / 5M Box | STCR5019 3/8" | 20 |
| 73350 | 1/2" Staples / 4M Box | STCR5019 1/2" | 20 |
| 73351 | 9/16" Staples / 4M Box | STCR5019 9/16" | 20 |

PowerCrown Outward Clinch Tacker - Model PC3000-OC2

Model PC3000-OC2 Features:

- Professional quality
- Drives 1/2" light wire Bostitch PowerCrown staples
- Powerful direct drive
- Unique design turns staple legs outward
- Convenient bottom load
- For pipe wrap, duct board and corrugated

| MARS NO. | DESCRIPTION | MFG. NO. | CASE QTY |
|----------|-------------------------|---------------|----------|
| 73343 | Outward Clinch Tacker | T6-60C2 | 12 |
| 73348 | 1/2" Staples / 5.8M Box | STCR2619 1/2" | 20 |

PowerClench™ Stapling Plier

Model P6C-8 Features:

- Ergonomic design
- Easy squeeze action
- Fast loading of staples
- Top loading

| MARS NO. | DESCRIPTION | MFG. NO. | CASE QTY |
|----------|-------------------------|----------|----------|
| 73352 | Stapling Plier | P6C-8 | 12 |
| 73353 | 3/8" staples / 5.8M Box | STH5019 | 20 |

MARS Multi Purpose Cutters

| MARS NO. | DESCRIPTION | MARS PACK | CASE QTY. |
|----------|---|-----------|-----------|
| 25656 | Compound ratchet action cutter, cuts hose, cable and plastic pipe 1 1/8" OD, replaceable blade, internal parts and pivots all stainless | 1 | 12 |

Vise-Grip® Locking Pliers And Clamps

MARS offers Vice-Grip hand tools for the HVAC/R contractor. MARS #25700 is a "Quick Pierce" Vise-Grip for the extraction of refrigerant from A/C units and appliances. Excellent for recovery applications. This plier adjusts to various tube sizes.

| MARS NO. | DESCRIPTION | MARS PACK | CASE QTY. |
|----------|-------------------------------------|-----------|-----------|
| 25700 | MARS Quick Pierce tool (pouch) | 1 | 1 |
| 25688 | Quick Pierce replacement tip (bulk) | 1 | 100 |



STANLEY
BOSTITCH
Stanley Fastening Systems

73343
73349



73346
73347
73348
73351
73353

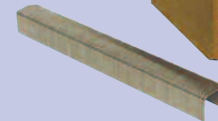

73352



25656

Master
VISE-GRIP



25700

SERVICE & INSTALLATION

Hand Tools

MARS SERIES **283**



Channellock Pliers

For over a century Channellock has been the leader in manufacturing professional quality tools for all trades. All tools are made in the U.S.A. The MARS line of Channellock tools are housed in attractive merchandiser hang type style packaging to generate impulse sales and increase your profits.

Channellock pliers are hand honed perfectly matched cutters which are heat treated to hold their edge. These pliers are precision made of fine polished, high carbon drop forged steel and features blue plastic comfort grips. MARS #28310, 9" linemans Wiremaster™ plier provides high leverage and an enclosed joint design to hold cutter in perfect alignment for the life of the plier.

Channellock Long Nose Pliers feature slender, perfectly matched jaws with no side wobble to provide a firm grip on fine work in tight places. MARS #28316 and #28317 also feature a side cutter.

The popular Tongue and Groove Pliers provide right angle teeth that grip in all directions for maximum bite and minimum wear. The undercut tongue and groove design assures the strongest non-slip jaw action and the patented PermaLock® fastener provides safer and smoother working than the old-time bolt and nut.

The Channellock crimping tool, MARS #28333, is used for crimping and cutting of both insulated and non-insulated solderless connections and terminals.

SERVICE & INSTALLATION

| MARS NO. | DESCRIPTION | MFG. NO. | CASE QTY. |
|----------|--|----------|-----------|
| 28301 | 7" cutting plier - lap joint diagonal | 337 | 20 |
| 28303 | 7 3/4" cutting plier - lap joint curved diag. | 447 | 20 |
| 28305 | 6" cutting plier - box joint | 436 | 20 |
| 28310 | 9" Wire Master™ linemans plier | 349 | 20 |
| 28311 | 9" high leverage linemans plier | 369 | 20 |
| 28316 | 7 1/2" Long Nose Plier with side cutter | 317 | 20 |
| 28317 | 6" Long Nose Plier with side cutter | 326 | 20 |
| 28323 | 9 1/2" Tongue & Groove Plier 5 Adjustments - 1 1/2" capacity | 420 | 20 |
| 28324 | 6 1/2" Tongue & Groove Plier 5 adjustments - 7/8" capacity | 426 | 20 |
| 28325 | 10" Tongue & Groove Plier 7 adjustments - 2" capacity | 430 | 20 |
| 28326 | 12" Tongue & Groove Plier 7 adjustments - 2 1/2" capacity | 440 | 20 |
| 28327 | 16" Tongue & Groove Plier | 460 | 20 |
| 28333 | Crimping tool | 909 | 20 |

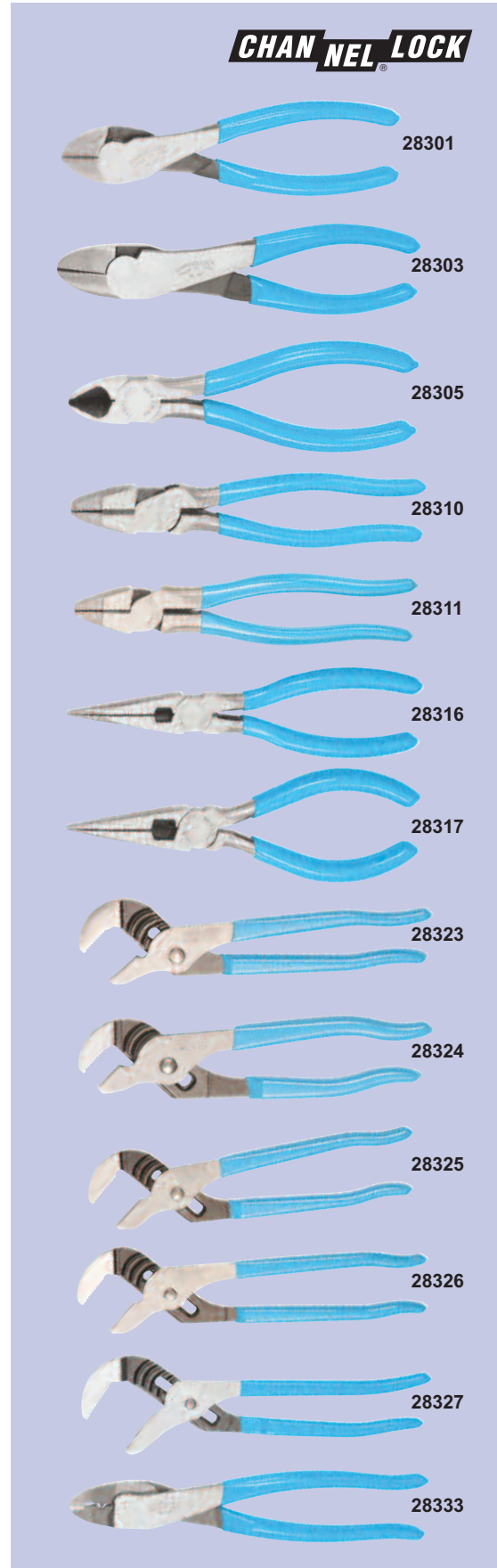



Fuse Pullers

MARS #25915, medium fuse puller is molded of tough, high impact nylon for greater strength. Handles with no-slip gripping surface, protective finger stops and yellow color are provided for extra safety.

| MARS NO. | DESCRIPTION | MFG. NO. | MARS PACK | CASE QTY. |
|----------|---------------------------------------|----------|-----------|-----------|
| 25915 | 7-1/4" medium puller for 0-100A fuses | 34-016 | 1 | 10 |

Torpedo Level

Torpedo level measures 9" and consists of aluminum frame. Has magnetic edge and "v" grooved edge for pipe work. A window in each vial provides easy reading of plumb, level and 45° mitre in dim lighting.

| MARS NO. | DESCRIPTION | MFG. NO. | MARS PACK | CASE QTY. |
|----------|------------------|----------|-----------|-----------|
| 25840 | 9" torpedo level | 35-205 | 1 | 3 |

Terminal Strips, 600V, 30a, UL & CSA

| MARS NO. | DESCRIPTION | MFG. NO. | MARS PACK | CASE QTY. |
|----------|---------------------------|----------|-----------|-----------|
| 25952 | 3 circuit terminal strip | 89-203 | 1 | 10 |
| 25953 | 4 circuit terminal strip | 89-204 | 1 | 10 |
| 25954 | 6 circuit terminal strip | 89-206 | 1 | 10 |
| 25955 | 8 circuit terminal strip | 89-208 | 1 | 10 |
| 25956 | 10 circuit terminal strip | 89-210 | 1 | 10 |
| 25957 | 12 circuit terminal strip | 89-212 | 1 | 10 |

Tap-Pak® Fish Tape

IDEAL Tape-Pak® fish tape reels and winders provide maximum strength and flexibility for fishing long runs of conduit. The case is built of high impact plastic that never dents or rusts. Use as a handle for pulling on fish tape to eliminate the dangers of bare-handed pulling as well as handy tape storage system. High grade tempered steel tape is fully protected and locked in reel when not in use so tape cannot kink spring free. Excellent for snaking long runs of thermostat wire.

| MARS NO. | DESCRIPTION | MFG. NO. | MARS PACK | CASE QTY. |
|----------|-----------------------------|----------|-----------|-----------|
| 25849 | 50' fish tape - 8 1/2" dia. | 31-033 | 1 | 1 |

Safe-T-Grip® Fuse Pullers

IDEAL's Safe-T-Grip® Fuse Pullers provide maximum efficiency and convenience when removing or replacing cartridge fuses. Constructed of fully insulated, reinforced, high-dielectric engineering plastic. Notched handles for a no-slip safe grip. Clearly marked amperage ranges. Moisture resistant...will not warp. Bright yellow in color.

| MARS NO. | DESCRIPTION | MFG. NO. | MARS PACK | CASE QTY. |
|----------|-----------------------------------|----------|-----------|-----------|
| 25911 | 5" midget for fuses 9/32-1/2 dia. | 34-001 | 1 | 1 |
| 25912 | 7 1/2" pocket for 0-100A fuses | 34-002 | 1 | 10 |
| 25913 | 11 3/4" giant for 31-600A fuses | 34-003 | 1 | 1 |



25915

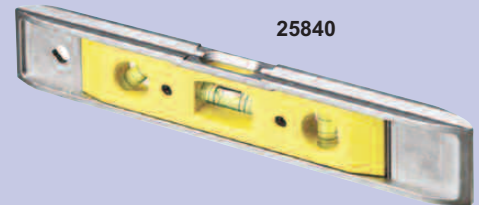

25840



25952



25849



25911

25912

25913

SERVICE & INSTALLATION

Electricians Hand Tools

MARS SERIES **256, 650 & 798**



Wire Strippers And Crimpers

Preferred by professionals for over three decades and originated by IDEAL, these quality built T[®]-strippers feature built in wire cutters, looping holes, cushioned plastic grips and precision knife-type blades that give an accurate, easy strip every time.

The MARS #25705 stripper is a versatile seven-function tool featuring spring loaded handles for quick and easy use, cushioned grips for comfort and a locking panel to keep jaws closed when not in use. It strips, cuts wire, crimps terminals, cuts bolts and screw, gauges 6-18 AWG wire, loops wire and reams conduit (reams and de-burrs).

The multi-crimp tool provides excellent leverage for sure, easy crimping and cutting...even in close quarters. Crimps bare or insulated terminals and splices on wire sizes 10-22 AWG.

| MARS NO. | DESCRIPTION | MFG. NO. | MARS PACK | CASE QTY. |
|----------|---|----------|-----------|-----------|
| 25701 | T [®] -5 Stripper 10-18 AWG solid | 45-120 | 1 | 10 |
| 25702 | T [®] -6 Stripper 16-26 AWG strand | 45-121 | 1 | 10 |
| 25703 | T [®] -8 Stripper 8-16 AWG strand | 45-124 | 1 | 10 |
| 25705 | 7-in-1 Stripper Crimper | 45-777 | 1 | 5 |
| 25711 | Multi-crimp Tool | 30-429 | 1 | 5 |

Refrigeration Wrenches

The Kwik-tite[®] ratchet wrenches (MARS #65079, 80, 81, 87) feature open jaw design which makes it easy to slip wrench onto fittings and fasteners - even in tight quarters. Flips quickly into tightening position with a sure grip on all hex surfaces. MARS #65082 is a combination wrench with the four sizes most needed for servicing air conditioning units. MARS #65083 & #65084 are designed for use on compressors with access valves in hard to reach places. This reversible ratchet is chrome plated.

| MARS NO. | MFG. NO. | DESCRIPTION | CASE QTY. |
|----------|----------|--|-----------|
| 65082 | 124C | 9/16" and 1/2" hex; 3/16" & 1/4" sq. ratchet | 1 |
| 65083 | 127C | 1/4", 3/8", 3/16", 5/16" square ratchet | 1 |

MARS Drill Screw Chuck With Magnetic Insert

| MARS NO. | DESCRIPTION | MARS PACK |
|----------|----------------------------|-----------|
| 79990 | 1/4" hex x 1 5/8", 1/card | 12 |
| 79991 | 5/16" hex x 1 5/8", 1/card | 12 |

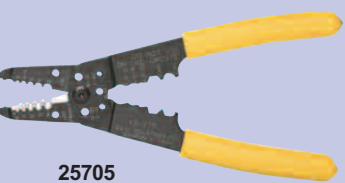
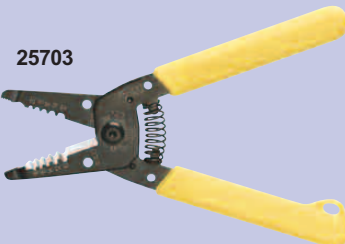
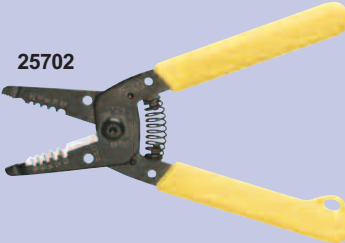
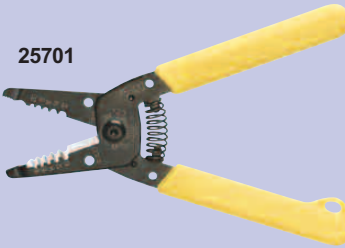

SERVICE & INSTALLATION



Hand Tools, Bits & Blades

MARS SERIES **256, 933 & 216**

MARS 6-in-1 Super Driver

The MARS Super driver features a comfort grip handle. The soft easy grip promotes excellent torque. This six-in-one driver includes 3/16" & 1/4" slotted bits, #1 & #2 phillips bits and 1/4" & 5/16" nutdriver. These screwdrivers are packaged twelve per counter display box.

| MARS NO. | DESCRIPTION | MARS PACK | CASE QTY. |
|----------|--------------------------|-----------|-----------|
| 25984 | MARS 6-in-1 super driver | 12 | 12 |

Red Devil Putty Knives And Wall Scrapers

Red Devil offers professional high quality putty knives and wall scrapers. The black polypropylene comfort grip handles are shatterproof and solvent resistant for safety. Durable, high carbon, steel precision-ground blades extend through handles for maximum dependability. The blade has a mirror lacquered finish to prevent rust. Made in the U.S.A.

| MARS NO. | DESCRIPTION | MARS PACK | CASE QTY. |
|----------|----------------------------------|-----------|-----------|
| 93402 | 1 1/4" wide stiff putty knife | 12 | 72 |
| 93280 | 1 1/2" wide stiff putty knife | 12 | 72 |
| 93403 | 1 1/4" wide flexible putty knife | 12 | 72 |
| 93281 | 2" wide flexible putty knife | 12 | 72 |
| 93404 | 3" wide flexible putty knife | 6 | 72 |

Magnetic Nut Setters

| MARS NO. | DESCRIPTION | CASE QTY. |
|----------|--------------------------------------|-----------|
| 21620 | 1/4" mag nut setter 2 9/16"L (1/cd) | 96 |
| 21621 | 5/16" mag nut setter 2 9/16"L (1/cd) | 60 |
| 21627 | 1/4" mag nut setter 6"L (1/cd) | 72 |
| 21628 | 5/16" mag nut setter 6"L (1/cd) | 72 |

Flex A Bit™ Kits (Patented Worldwide)

| MARS NO. | DESCRIPTION | CASE QTY. |
|----------|---------------------------------------|-----------|
| 21669 | 11" industrial flex a bit plus (1/cd) | 36 |

Superior Tool Mini Hacksaw And Blades

| MARS NO. | DESCRIPTION | MARS PACK | CASE QTY. |
|----------|---|-----------|-----------|
| 25668 | 10" mini hacksaw - cuts wood, plaster, steel, brass, etc., cushioned handle | 1 | 6 |
| 25669 | 6" high carbon steel repl. blades (10/card) | 1 | 6 |



SERVICE & INSTALLATION

Knives & Blades

MARS SERIES **274 & 932**



Utility Knives And Blades

MARS #27401, retractable utility knife features a four position metal slider which accepts any utility blade. Zinc die cast construction. One heavy duty blade is provided with tool. Replacement heavy duty utility blades, MARS #27403, fits most utility knives. Used for cutting drywall, fiberglass, wood, plastic, cardboard and more!

| MARS NO. | DESCRIPTION | MARS PACK | CASE QTY. |
|----------|---------------------------------------|-----------|-----------|
| 27401 | Retractable utility knife with blade | 5 | 100 |
| 27403 | H.D. utility blade (10 per dispenser) | 10 | 60 |

Breakaway Knives And Blades

MARS #27410, is a heavy duty, retractable, 8 point, breakaway knife with a unique internal blade storage. The strong steel shank is molded into the durable plastic handle. Blade locks in place. Snap-cap tool accepts all standard 8 point blades. Ideal for cutting and trimming cardboard, wood, leather and more. Knife is carded and packaged with 3 blades.

The 13 point heavy duty retractable breakaway knife also features a unique internal blade storage where the steel shank is molded into the durable plastic handle. The blade locks in place and the snap-cap doubles as a pocket clip. Accepts all standard 13 point blades. Ideal for cutting and trimming wall coverings, vinyl, paper and more. Knife packaged with 3 blades.

| MARS NO. | DESCRIPTION | MARS PACK | CASE QTY. |
|----------|-----------------------------------|-----------|-----------|
| 27410 | H.D. 8 point knife with 3 blades | 10 | 100 |
| 27411 | 8 point break blade (5/card) | 10 | 60 |
| 27412 | H.D. 13 point knife with 3 blades | 10 | 200 |

Red Devil Knives And Blades

Red Devil's all purpose adjustable utility knife, #93271 is made of diecast metal and has a unique button lock blade to cut in 3 different positions. Contains an extra blade and is carded for hanging.

The heavy duty utility knife, #93274, has a breakaway blade design and has many uses. Posi-lock pull back button retains blade safely and tightly in cutting position. Stainless steel break away blade has eight sharp cutting edges. The automatic razor knife, #93275, is a heavy duty premium break away blade tool. The package includes 80 cutting edges, 3 blades in knife, 7 in dispenser. Both break away knives come attractively carded for your display.

| MARS NO. | DESCRIPTION | MARS PACK | CASE QTY. |
|----------|----------------------------------|-----------|-----------|
| 93271 | Adjustable utility knife | 6 | 72 |
| 93273 | Blade for 93271, 5/card | 10 | 120 |
| 93274 | Heavy duty utility knife | 6 | 72 |
| 93275 | Automatic razor knife | 12 | 72 |
| 93276 | Blades for 93274, 93275, 3/card | 10 | 150 |
| 93277 | Blades for 93274,5, 10/dispenser | 12 | 144 |

Techni Edge



SERVICE & INSTALLATION



Protective Garments & Safety Equipment

MARS SERIES **257, 795 & 782**

Knee Pads

The Superflex™ knee pads provide super duty protection for tough jobs. The long, soft rubber black cap is designed for traction and full knee coverage. Color: black. MARS #25679 includes a buckle fastening system.

| MARS NO. | DESCRIPTION | CASE QTY. |
|----------|----------------------------------|-----------|
| 25679 | Superflex™ knee pads with buckle | 20 |

Dust Masks

| MARS NO. | DESCRIPTION | CASE QTY. |
|----------|------------------------------------|-----------|
| 79170 | 50 pc. box, dust mask | 12 |
| 79169 | 20 pc. box, dust & mist respirator | 12 |

MARS Disposable Shoe Covers

Amphibious shoe covers are waterproof and made of a 6 MIL copolymer with a non slip embossed sole. In addition to providing protection to the customer's property, Amphibious shoe covers also keep the shoes dry when working in wet grass or hosing down equipment. Premium shoe covers are made of heavyweight breathable polypropylene with a non-slip PVC zigzag sole.

| MARS NO. | DESCRIPTION | MARS PACK | CASE QTY. |
|----------|--|-----------|-----------|
| 79195 | Amphibious shoe covers - 300 XL covers/box | 1 | 10 |
| 79100 | Premium shoe covers - 300 XL covers/box | 1 | 10 |
| 79103 | Premium shoe covers - 50 XL covers/box | 1 | 1 |
| 79199 | Copolymer shoe covers - 5 XL covers/box | 1 | 1 |

MARS Smoke Candles

| MARS NO. | DESCRIPTION | CASE QTY. |
|----------|--------------------------------|-----------|
| 79534 | 4000 cu. ft. smoke, 30 seconds | 12 |
| 79535 | 8000 cu. ft. smoke, 1 minute | 12 |



SERVICE & INSTALLATION

Industrial Work Gloves

MARS SERIES **782**



Cotton/Jersey Gloves

| MARS NO. | DESCRIPTION | MARS PACK | CASE QTY. |
|----------|--|-----------|-----------|
| 79143 | 8 oz. cotton canvas gloves/individual pack | 1 | 12 |
| 79149 | 10 oz. cotton hob nob/individual pack | 1 | 12 |
| 79151 | 9 oz. brown jersey glove/individual pack | 1 | 12 |
| 79148 | 9 oz. hob nob jersey | 1 | 12 |
| 79153 | Fleece lined cotton jersey/individual pack | 1 | 12 |

Leather Gloves

| MARS NO. | DESCRIPTION | MARS PACK | CASE QTY. |
|----------|--|-----------|-----------|
| 79157 | Leather palm safety cuff/individual pack | 1 | 12 |
| 79159 | Split cowhide leather (suede) | 1 | 12 |
| 79166 | Grain cowhide leather | 1 | 12 |
| 79162 | Medium truckers glove | 1 | 12 |
| 79165 | Large truckers glove | 1 | 12 |

PVC/Nitrile/Neoprene Gloves

| MARS NO. | DESCRIPTION | MARS PACK | CASE QTY. |
|----------|-------------------------------|-----------|-----------|
| 79145 | PVC long gauntlet cuff gloves | 1 | 12 |
| 79147 | Coated neoprene gauntlet cuff | 1 | 12 |

MARS Disposable Gloves

Disposable vinyl, latex, and nitrile gloves are heavy weight 5 mil and powdered. Packaged in a convenient dispenser box.

| MARS NO. | DESCRIPTION | MARS PACK | CASE QTY. |
|----------|----------------------------------|-----------|-----------|
| 79096 | Nitrile Gloves - L 100/box | 1 | 10 |
| 79097 | Nitrile Gloves - XL 100/box | 1 | 10 |
| 79092 | Latex Gloves - L 100/box | 1 | 10 |
| 79098 | Latex Gloves - XL 100/box | 1 | 10 |
| 79093 | Vinyl Gloves - L 100/box | 1 | 10 |
| 79099 | Vinyl Gloves - XL 100/box | 1 | 10 |
| 79200 | Black Nitrile Gloves - L 100/box | 1 | 10 |

Black Mamba Gloves

- Made with a patented NITREX® polymer
- Super strong (6.0 mils) powder free nitrile glove
- 3 times the chemical and puncture resistance of a comparable thickness latex or vinyl glove
- Grip rite finish for secure handling

| MARS NO. | DESCRIPTION | MARS PACK | CASE QTY. |
|----------|-----------------------------------|-----------|-----------|
| 79200 | Black Nitrile Gloves – L 100/box | 1 | 10 |
| 79138 | Black Nitrile Gloves – XL 100/box | 1 | 10 |



SERVICE & INSTALLATION

Hand Cleaners

MARS SERIES **931 & 932**



Goop Hand Cleaners

For nearly 50 years, Goop has been the only name you need to know in hand cleaners. It's a name that wholesalers and contractors alike know and trust. Goop is non-toxic and biodegradable. Goop will remove almost anything...from almost everything. Use Goop to clean the dirtiest, greasiest hands. Use it for other tough cleaning jobs as well, such as removing stains from washable clothing, cleaning vinyl, plastic, canvas, floor tile - or whatever else gets dirty.

| MARS NO. | DESCRIPTION | MARS PACK |
|----------|-------------|-----------|
| 93150 | 14 oz. can | 12 |

Orange Goop Hand Cleaners

For customers who want a fresh orange scent in a tough, natural liquid hand cleaner, get the Orange Goop. There are no harsh solvents - just natural citrus. Available in regular or pumice formula. Biodegradable, too. Orange Goop...just another example of how we're giving today's contractors what they want.

| MARS NO. | DESCRIPTION | MARS PACK |
|----------|---|-----------|
| 93157 | 14 oz. can | 12 |
| 93160 | 16 oz. liquid squeeze bottle | 12 |
| 93162 | 1/2 gallon orange pumice liquid w/ pump | 6 |
| 93163 | 16 oz. liquid squeeze bottle w/ pumice | 12 |

CRC Citrus Hand Cleaner

CRC Mechanix Orange™ citrus hand cleaners are petroleum solvent free, natural formulations that effectively remove grease, oil, grime, paint and inks safely and quickly. The citrus based formula is PH balanced, highly concentrated and fortified with aloe vera, and other conditioners to help keep hands soft and smooth. All this with the great new scent of citrus. Fine pumice is easy on your skin.

| MARS NO. | DESCRIPTION | MARS PACK |
|----------|--------------------------|-----------|
| 93228 | Mechanix Orange™, 16 oz. | 12 |

Scrubs in-a-Bucket™

Scrubs in-a-Bucket™ provide fast, easy and effective hand cleaning with portability. Can be used anywhere, anyplace, anytime on the toughest soils, greases, tar, graphite...even printers ink. Each dispensing canister contains 10 1/2" x 12 1/4" perforated high-strength absorbent cleaning towels, treated with a gentle-to-the-skin but effective heavy duty grease cutting and soil lifting formulation. Pumice performance, without the messy, gritty pumice! Leaves skin lotion-soft, with a natural citrus fragrance. Contains germ fighting Triclosan. No rinsing, no drying, no residue. Also ideal for cleaning tools, work in process and for spills.

| MARS NO. | DESCRIPTION | MARS PACK | CASE QTY. |
|----------|---------------------------------|-----------|-----------|
| 93201 | Scrubs in-a-Bucket™ (72 towels) | 6 | 42 |
| 93203 | Scrubs in-a-Bucket™ (30 towels) | 6 | 72 |



SERVICE & INSTALLATION



The largest selection of motors, components and accessories for the HVAC/R Industry

Maintenance Products

MARS SERIES **787, 790 & 932**



MARS Zoom Spout® Products

Used by virtually every mechanic and technician in the heating, ventilation, air conditioning and refrigeration field.

93240 Zoom Spout® Oiler

- Contains 4 oz. highest quality turbine oil
- Rust and oxidation inhibited
- Paraffin base...non-gumming
- Use on motor bearings and bushings
- Squeeze bottle action
- Spout extends to 14", wipes dry
- SAE 10 weight
- Non detergent

93241 Rust Buster

- Loosens rusted bolts, nuts, shafts, etc.
- Cleans corroded and dirty parts
- Contains no harsh chemicals such as acid or alkali
- Spout wipes itself dry
- Contents always visible
- Won't short out
- Spout extends to 14"

| MARS NO. | DESCRIPTION | MARS PACK | CASE QTY. |
|----------|-------------------------|-----------|-----------|
| 93240 | Zoom Spout® Oiler 4 oz. | 12 | 72 |
| 93241 | Rust Buster 4 oz. | 12 | 72 |

MARS Maintenance Products

| MARS NO. | DESCRIPTION | MARS PACK | CASE QTY. |
|----------|---------------------------------------|-----------|-----------|
| 79036 | WD-40 8 oz. spray smart straw, No CA | 12 | 24 |
| 79037 | WD-40 11 oz. spray smart straw, No CA | 12 | 12 |
| 79006 | WD-40 8 oz. spray smart straw CA | 12 | 24 |
| 79007 | WD-40 11 oz. spray smart straw CA | 12 | 12 |

Kimberly-Clark Disposable Wiper/Towels

Kimberly-Clark® Kimtex® wipers are heavy duty oil and solvent wipers. Strong and durable, cloth-like feel and performance.

Kimberly-Clark® Kimtowels® are highly absorbent and versatile multi-ply tissue wipers. They quickly absorb water, oil and grease. Textured side for tough jobs and soft side for personal wiping. Contains no additives or glues.

Kimberly-Clark® Teri® wiper is durable for demanding jobs. Strong, even when wet. This 4-ply tissue wiper traps dirt and absorbs liquids quickly. Made with 100% recycled paper.

Workhorse™ manufactured rags by Kimberly-Clark® are made of a Hydroknit™ fast absorbing material. Workhorse™ rags stand up to water, oil, solvents and chemicals without falling apart. Amazingly strong when wet. Highly resistant to rips and tear wet or dry. Workhorse™ is the versatile and economical alternative to rags.

| MARS NO. | DESCRIPTION | MARS PACK | CASE QTY. |
|----------|---|-----------|-----------|
| 79110 | Kimtex® 100 pc. pop-up™ box, 9-3/4" x 16-3/4" | 1 | 5 |
| 79109 | Kimtowels® 88 pc. pop-up™ box, 9-3/4" x 16-3/4" | 1 | 10 |
| 79105 | Teri® wipers 136 pc. pop-up™ box, 9-3/4" x 16-3/4" | 1 | 10 |
| 79111 | Workhorse™ manufactured rags, 150 pc. brag box, 12" x 16-3/4" | 1 | 1 |

MARS Shop Towels

MARS shop towel rags are 100% cotton material. This 15" x 15" red cloth towel is extra absorbent and ideal for cleaning up grease on tools or machinery. Long lasting and machine washable. Hemmed edges.

The MARS 100% cotton terry towel is an all purpose, white terry cloth towel that can be used for drying, polishing, dusting and waxing.

| MARS NO. | DESCRIPTION | MARS PACK | CASE QTY. |
|----------|--------------------------------|-----------|-----------|
| 79025 | White terry towel (12 pack) | 1 | 12 |
| 79026 | Red cloth shop towel (12 pack) | 1 | 18 |
| 79027 | Red cloth shop towel (50 pack) | 1 | 6 |



SERVICE & INSTALLATION



Maintenance Products

MARS SERIES **787, 790 & 932**

32 oz. Spray Bottle

| MARS NO. | DESCRIPTION | MARS PACK |
|----------|---------------------|-----------|
| 79009 | 32 oz. Spray Bottle | 12 |

Blue Huck Towels

- Excellent absorbency!
- 5 lb. box
- Lint free
- Prewashed
- Approx. 22" x 13"
- 30-35 towels in box

| MARS NO. | DESCRIPTION | MARS PACK |
|----------|------------------|-----------|
| 79024 | Blue Huck Towels | 1 |

Dyna-Wipes

- No Water Needed
- Removes Odors From Hands
- Gentle On Hands With 4 Skin Conditioners
- Non-Flammable
- Towel Size 9" x 12", 80 Towels In Each Tub

Use Them For:

- Hands
- Vinyl Windows
- Sports Equipment
- Leather
- Vinyl
- Much More!!
- Soiled Garments
- Tools & Equipment
- Counters
- Keyboards
- Stainless Steel Surfaces

Removes:

- Coffee Stains
- Permanent Marker
- Nail Polish
- Labels & Residue
- Urethane Sealants
- Carpet Spots
- Tar & Asphalt
- Gasket Cement
- Paints & Varnishes
- Many Inks
- Caulking
- Tree Pitch
- Scuff Marks
- Pipe Cement
- Most Graffiti
- Crayon Marks
- Counter Stains
- Plumbers Cement
- Tape Residue

Keep some with you... Wherever you go!

- RV's
- Cars
- Work Vans
- Shops
- Hiking
- Kitchens
- Fishing
- Garages
- Boats
- Sports
- Camping
- Bathrooms

| MARS NO. | DESCRIPTION | MARS PACK |
|----------|-------------|-----------|
| 93200 | Dyna-Wipes | 8 |



SERVICE & INSTALLATION



The largest selection of motors, components and accessories for the HVAC/R Industry

Sealant Products

MARS SERIES **934**



MARS RTV Silicone Sealants

MARS HVAC/R Silicone Sealant is a superior quality silicone which remains flexible from -85° to 500°F. Never dries out. Has excellent adhesion to metals and can be used for virtually every HVAC need.

| MARS NO. | DESCRIPTION | MARS PACK | CASE QTY. |
|----------|----------------------------------|-----------|-----------|
| 93246 | Silicone sealant almond 10.1 oz. | 12 | 12 |
| 93249 | Silicone sealant clear 10.1 oz. | 12 | 12 |
| 93251 | Silicone sealant white 10.1 oz. | 12 | 12 |
| 93252 | Silicone sealant gray 10.1 oz. | 12 | 12 |
| 93264 | Silicone sealant black 10.1 oz. | 12 | 12 |
| 93253 | Silicone sealant clear 2.8 oz. | 12 | 12 |
| 93254 | Silicone sealant white 2.8 oz. | 12 | 12 |

MARS Heat Resistant Silicone

MARS HVAC/R Hi-Temp Red Silicone Sealant is a superior quality silicone which was formulated to perform at temperatures ranging from -85°F to 500°F (-65°C to 260°C) for continuous operation and 600°F (316°C) for intermittent exposure. These features make MARS HVAC/R Hi-Temp red Silicone ideal for use around furnace vent pipes, restaurant hoods and heat exchangers.

| MARS NO. | DESCRIPTION | MARS PACK | CASE QTY. |
|----------|-------------------------------------|-----------|-----------|
| 93255 | Hi-Temp. silicone red 10.1 oz. | 12 | 12 |
| 93247 | Heat resistant silicone red 2.8 oz. | 12 | 12 |

Fire Stop Caulk

Red Devil Fire Stop Caulk effectively seals penetration openings against the spread of fire, smoke, toxic gases and water when applied properly.

- A Latex-based, high-solids Fire Stop compound
- No Shrinkage
- Withstands temperatures up to 2000° F and is up to 4 hour fire rated
- Sandable and Paintable
- Meets Fed. Specs ASTM E-814 (UL 1479) and ASTM E-84 (UL 723) and many UL Classifications

| MARS NO. | DESCRIPTION | CASE QTY. |
|----------|----------------------------------|-----------|
| 93293 | Firestop Caulk, 10.5 FL Oz.- Red | 12 |

Red Devil Celulon And Acrylic Caulk

Celulon™ plumbing and HVAC adhesive sealant is sometimes preferred over silicone. This easy to apply adhesive sealant adheres to all substances, is paintable, cleans up with water and has no offensive odor. Used to seal A/C ducts and lines. Application temp: 40° to 90°F. Service temp: -25° to 200°F.

| MARS NO. | DESCRIPTION | MARS PACK | CASE QTY. |
|----------|-------------------------------------|-----------|-----------|
| 93256 | Celulon HVAC sealant clear 10.1 oz. | 12 | 12 |
| 93257 | Celulon HVAC sealant white 10.1 oz. | 12 | 12 |
| 93258 | 35 yr. acrylic caulk gray 10.1 oz. | 12 | 12 |



SERVICE & INSTALLATION



Red Devil Butyl Sealants

Red Devil's butyl sealant is a high performance rubber-like sealant that is ideal for tough outdoor jobs and below grade applications. (marine usage above waterline) It can be used wherever watertight seal is required. This paintable sealant provides excellent adhesion to most building surfaces including aluminum, stone, wood, brick, fiberglass, plastic, metal, etc. This sealant is ideal for use on window/door frames, aluminum gutters, chimney roofs, concrete foundations etc. Sealant remains rubbery and flexible from 0°F to 225°F after full cure.

| MARS NO. | DESCRIPTION | MARS PACK | CASE QTY. |
|----------|-----------------------------|-----------|-----------|
| 93290 | Butyl sealant white | 12 | 12 |
| 93291 | Butyl sealant aluminum gray | 12 | 12 |
| 93292 | Butyl sealant bronze | 12 | 12 |

Red Devil Specialty Products

Red Devil's blacktop & roof repair is water resistant and stays flexible. This butyl rubber asphalt sealant adheres to cinder block, wood asphalt, concrete, brick and metal. Use on blacktop driveway cracks, chimney flashings, shingles & skylights. Apply at temperatures between 10°F & 100°F. Full cure in 72 hours

Red Devil speed demon latex caulk is a general purpose caulk that applies easily, dries quickly is paintable and won't stain or bleed.

Red Devil's QPF™ tub & tile caulk provides a long lasting water-tight seal around tubs, showers & sinks. This odorless and mildew resistant caulk is paintable & wont stain or bleed. The acrylic based caulk features a quick protection formular (QPF) which forms a protective outer covering in seconds allowing a bath or shower within 3-4 hours use of application.

| MARS NO. | DESCRIPTION | MARS PACK | CASE QTY. |
|----------|-------------------------------|-----------|-----------|
| 93244 | Blacktop & roof repair black | 12 | 12 |
| 93265 | Speed demon latex caulk white | 12 | 12 |
| 93248 | Tub & tile caulk white | 12 | 12 |

Expanding Foam Sealing Products

MARS foam sealant is a multi-purpose expanding polyurethane foam sealant, designed for the professional contractor. Excellent for HVAC projects and wall/floor penetrations. It is ideal for sealing around air conditioners, vents, ducts, electrical and plumbing penetrations. The Handi-Foam, MARS #93243, is a two component polyurethane foam to seal, bond, retrofit, insulate and dampen sound. Excellent for use in the HVAC, plumbing, roofing, cold storage, transportation and building maintenance applications, Expands and cures within seconds. Conforms to any shape. Each kit contains 2 cans (.88 lbs. ea.) of polyurethane expanding foam, two spray nozzles with 24" hoses and 1" clamp. Covers one cubic foot (12 board feet).

| MARS NO. | DESCRIPTION | MARS PACK | CASE QTY. |
|----------|---------------------|-----------|-----------|
| 93268 | Foam sealant 12 oz. | 12 | 12 |
| 93267 | Foam sealant 24 oz. | 12 | 12 |
| 93243 | Handi-Foam | 1 | 12 |

MARS Duct Seal Putty

MARS Duct Sealing Putty is a non-hardening, non-toxic, gray putty compound used for countless applications in the refrigeration, heating and cooling, electrical trade, and plumbing fields. It can be shaped by hand to any form, and reused if necessary, for plugging openings through foundations, sealing around electrical boxes, refrigeration tube entry and so much more.

| MARS NO. | DESCRIPTION | MARS PACK | CASE QTY. |
|----------|--------------------|-----------|-----------|
| 93520 | 1 lb. slug - boxed | 1 | 10 |
| 93521 | 5 lb. slug - boxed | 1 | 10 |
| 93522 | 2 lb. slug - boxed | 1 | 10 |



SERVICE & INSTALLATION

Sealant Products

MARS SERIES **934**



Caulking Guns

For your convenience, MARS also offers easy to load and operate caulking guns. Guns hold the standard 10.3 oz. cartridges. MARS #93269 skeleton gun is ideal for large jobs. This heavy duty but light weight unit saves time in loading for the busy contractor. The professional skeleton gun, MARS #93278, offers three times more thrusting power with a smooth rod parallel frame. The professional ratchet type caulking gun, MARS #93279, is a professional conventional type gun recommended for sealants from light to heavy consistencies.

| MARS NO. | DESCRIPTION | MARS PACK | CASE QTY. |
|----------|------------------------------------|-----------|-----------|
| 93269 | Skeleton caulking gun | 1 | 24 |
| 93278 | Professional skeleton caulking gun | 1 | 12 |
| 93270 | Econo conventional caulking gun | 1 | 24 |
| 93279 | Professional ratchet caulking gun | 1 | 24 |



Pipe Insulating Cork Tape

MARS SERIES **932**



MARS Cork Tape - 1/8" x 2" x 30' Roll

MARS Cork Tape is ozone resistant and specially designed for all types of climate. It insulates cold pipes for all kinds of air conditioners, freezers, and refrigerators. Cork Tape helps stop condensation problems. It is ideal for retarding heat gain in cold pipes and prevents heat loss in hot pipes. Can also be used for gasketing purposes. MARS Cork Tape sticks to all kinds of dry metals. This flexible tape seals tightly without drying. Temperature range: -20°F to 200°F / -29°C to 93°C.

Corktape is made from virgin cork specially imported from Portugal & Spain and has the following characteristics:

1. Compared to other cork tapes - our cork tape features rubber/asphalt & 100% virgin cork instead of asbestos / saw dust as used by other manufacturers.
2. The width is always 2" wide unlike other brands where size varies from 1-3/4" - 2".
3. Very good adhesion property. It sticks on the metal pipe tightly and does not come out in one piece if unwrapped.
4. A wide service temperature range -29° F - +200° F
5. Once installed the outer surface dries creating a shield against unwanted dust and dirt while the inner side remains wet. So even after a year or two, the user can remove the cork tape and reapply elsewhere without any change in the properties of the tape. Other brands such as Prestite/Virgin are mostly wet outside and inside making it vulnerable to dust and dirt which eventually deteriorates its insulation properties.

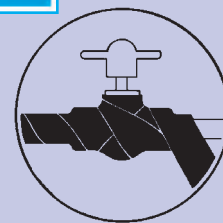

Thickness To Prevent Pipe Condensation

| Ambient Temperature & %RH | Pipe Temperature | |
|---------------------------|-----------------------------------|-----------------------------------|
| | 50°F (10°C) | 32°F (0°C) |
| 77°F (25°C) & 50% RH | Double Layer | Triple Layer |
| 85°F (29°C) & 70% RH | Double Layer plus Double Layer | Triple Layer Plus Triple Layer |

| MARS NO. | DESCRIPTION | MARS PACK | CASE QTY. |
|----------|-------------|-----------|-----------|
| 93505 | Cork Tape | 1 | 12 |

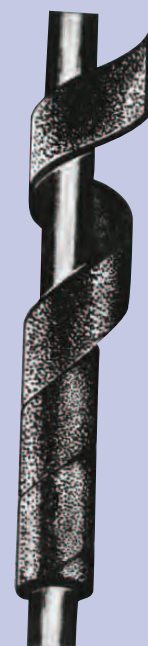

Physical properties:

Composition:
Polymer based material containing synthetic rubbers, asphalt and approximately 50% cork by volume. It has a grainy rubber-like consistency and contains no asbestos.

Solid Contents:
99.8%

Color:
Black

Thermal Conductivity:
0.60 BTU/hr /ft²/F/in at 75°F

Moisture / Vapor Transmission:
0.02 perms.
(ASTM E-90 Procedure C)

Water Absorption:
0.01% by volume
(ASTM D-1056)

Ozone Resistance:
Good



Self Adhesive Insulation Foam Tape

MARS SERIES **932**

MARS Foam Tape - 1/8"X 2"X 30' Roll

MARS Foam Tape is a self-adhering closed cell thermal insulation tape. This flexible tape is ideal for wrapping hot or cold pipings and fittings. The energy saving and very easy to use Foam Tape is excellent for preventing condensation problems. MARS Foam Tape is designed for retarding heat loss in hot pipings and preventing heat gain or frost formation on cold, chilled water pipings or refrigerant lines. Adheres firmly to all metals. Temperature range: -20°F to 200°F / -29°C to 93°C.

1. Good weather and UV resistant - reason being EPDM (Ethylene Propylene Diene Monomer) is the main compound in the manufacturing of Foamtape. In practice EPDM is also used in the manufacturing of glass window strips of cars, which lasts for more than 10 years outdoors without any replacement (inspite of being exposed to rain, heat & cold).
2. The specially coated acrylic adhesive provides extra adhering strength compared to other tapes. Once installed, the special adhesive will act as the bonding agent and won't let the tape delaminate.
3. Low thermal conductivity (0.26 BTU. in/sq. ft. hr. deg. F at 75°F) to prevent heat loss/heat gain and save energy.
4. An ozone friendly product manufactured under strict supervision of trained personnels with quality check at every production point.
5. Low halogen contents. Tests have proved that MARS Foam Tape (or FOAMTAPE excluding the adhesive) has chlorine and bromine content of 4.36% and 1.35% compared to NBR/PVC (Armstrong, Rubatex) based brand insulation which has 12.45% and 6.14% respectively.
6. Our vulcanization system uses negligible amount of Sulphur (chemical which corrodes copper tubings) and this special vulcanization process decomposes chemicals almost completely.

Thickness To Prevent Pipe Condensation

| Ambient Temperature and Relative Humidity | Pipe Temperature | |
|---|-------------------------------|------------------------------|
| | 50°F (10°C) | 35°F (2°C) |
| 80°F (27°C) & 50% RH | Single Layer | 50% Overlap |
| 85°F (30°C) & 70% RH | 50% Overlap plus Single Layer | 50% Overlap Plus 50% Overlap |

| MARS NO. | DESCRIPTION | MARS PACK | CASE QTY. |
|----------|-------------|-----------|-----------|
| 93506 | Foam Tape | 1 | 12 |

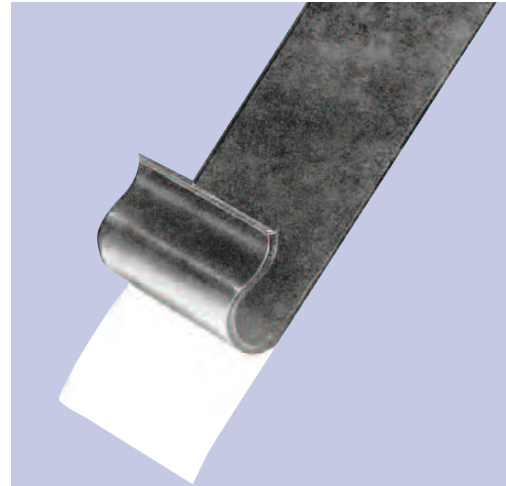

Physical properties:

Composition:

Closed cell, elastomeric thermal insulation.

Color:

Black

Density:

6±1 pounds per cubic feet.
(0.09-0.12 g/cm³)
(ASTM D-1667)

Thermal Conductivity:

0.26 BTU in./ft² hr. °F at 75°F
(0.04 W/mK at 24°C)
(ASTM C-177)

Water Absorption:

Max 5% by weight
(ASTM D-1056)

Water Vapor Permeability:

0.15 Perm-inch (ASTM C-355)

Temperature Range:

-20°F (-29°C) to +200°F (+93°C)

SERVICE & INSTALLATION



Maintenance Products

MARS SERIES **934**

Mortite Pipe Wraps

Mortite's no-drip® tape stops cold water pipe sweating permanently. Won't dry out, crack or shrink. This self-adhering tape insulates hot water pipes up to 160°F. No-drip® tape molds around valves, joints, tees and irregular fittings. The 2"W x 30'L roll covers 30 lineal feet of 1/2" O.D. pipe. Provides clean, neat appearance.

| MARS NO. | DESCRIPTION | CASE QTY. |
|----------|-------------------------------|-----------|
| 93516 | No-drip® tape - 2" x 30' roll | 10 |



Maintenance Products

MARS SERIES **932**



Mortite Weather Stripping Products

MARS #93507, air conditioner window seal, seals the gap between window sill and air conditioner. This permanent, all season foam strip prevents heat loss in winter, cooling loss in summer. Attractively packaged in a colorful poly bag for pegboard merchandising.

Mortite's closed-cell foam tape, MARS #93509 seals better in hot and cold climates. This durable vinyl tape stands up to extreme cold temperatures and will not freeze. Closed-cell means the cells prevent air from passing through the weatherstrip tape and won't absorb moisture. Self adhering, seals out drafts, dust and insects better than open-cell tape. MARS #93509 cushions and eliminates noisy vibrations around storm windows, A/C's and small appliances.

| MARS NO. | DESCRIPTION | CASE QTY. |
|----------|--|-----------|
| 93507 | Foam strip - 1/4" x 1-1/4" x 42"L | 12 |
| 93509 | Closed cell foam tape 3/8"T x 3/4"W x 10'L | 12 |

Mortite A/C Foam Filter

Mortite's air conditioner filter helps to keep the room free from outside dust and dirt while increasing efficiency. This polyurethane foam filter is easy to install. And the 15" x 24" size can be cut to fit all window and through-wall air conditioners. Easy to clean - requires only regular detergent and water. Reusable.

| MARS NO. | DESCRIPTION | CASE QTY. |
|----------|-------------------------|-----------|
| 93524 | Foam filter - 15" x 24" | 24 |

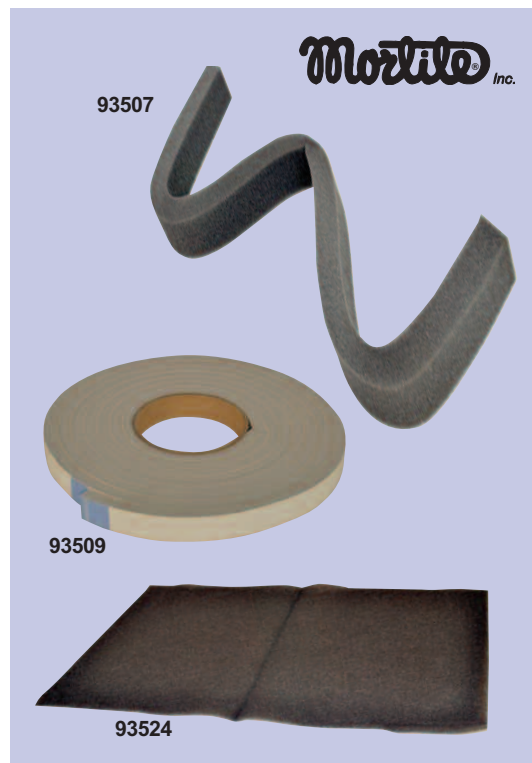

SERVICE & INSTALLATION

Tapes & Supplies

MARS SERIES **789**



Cloth Duct Tapes

MARS is committed to supply high quality tape products to the HVACR industry. MARS offers 5 grades of the most popular duct tapes for a wide variety of applications.

MARS #79070 is the tape of choice for professional contractors. This double-calendered adhesive system is designed to meet the most rigorous demands of HVAC and asbestos removal specialists. Also available in black.

MARS #79072 and 79073 are recommended for use in many heating, air conditioning, ventilating and refrigeration applications.

MARS #79074 and 79075 has an excellent adhesion for a wide variety of surfaces. Excellent for most industrial applications.

MARS econo grade is an all around economical duct tape product for binding, patching and repair applications.

MARS #79088 is a heavy duty printed duct tape used to seal metal duct work, fiberglass insulations and to cover thermal insulations. Will not twist or curl during application. Meets UL723. Max temp 200°F with 4-1/2" repeat.

| MARS NO. | DESCRIPTION | SIZE | MARS PACK |
|----------|---------------------------|--------------|-----------|
| 79070 | Premium grade silver | 2" x 60 yds. | 24 |
| 79071 | Premium grade black | 2" x 60 yds. | 24 |
| 79072 | Professional grade silver | 2" x 60 yds. | 24 |
| 79073 | Professional grade black | 2" x 60 yds. | 24 |
| 79074 | Industrial grade silver | 2" x 60 yds. | 24 |
| 79075 | Industrial grade black | 2" x 60 yds. | 24 |
| 79076 | Plumbers grade silver | 2" x 60 yds. | 24 |
| 79077 | MARS econo grade silver | 2" x 60 yds. | 24 |
| 79088 | Heavy duty printed black | 2" x 60 yds. | 24 |

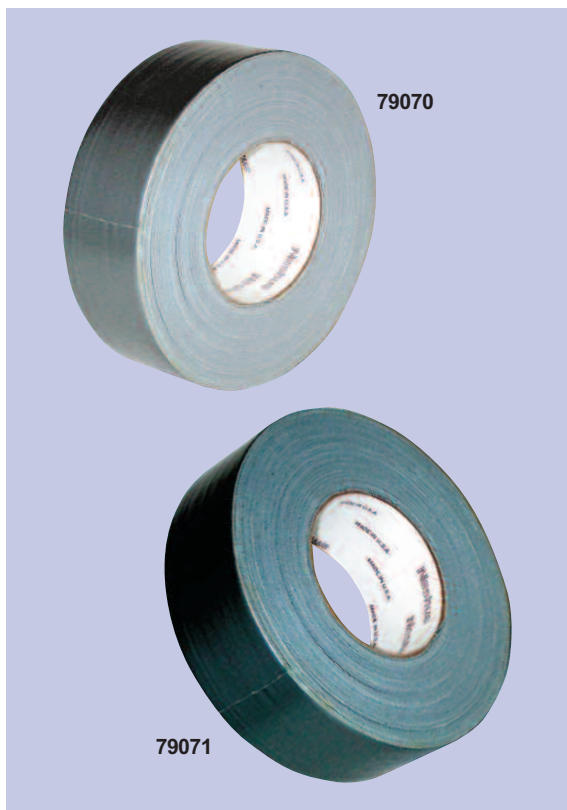



MARS Foil Duct Tapes

MARS #79081 and 79082 are dead-soft aluminum foils with aggressive adhesive properties. The FSK foil scrim kraft tape is a fiberglass scrim reinforced foil that gives the tape high tensile strength, yet it is flexible and easy to use.

| MARS NO. | DESCRIPTION | SIZE | MARS PACK |
|----------|-----------------------|--------------|-----------|
| 79081 | Aluminum foil tape | 2" x 50 yds. | 24 |
| 79082 | Aluminum foil tape | 3" x 50 yds. | 16 |
| 79083 | Foil scrim kraft tape | 2" x 50 yds. | 24 |
| 79084 | Foil scrim kraft tape | 3" x 50 yds. | 16 |

U.L. Listed Tapes

MARS #79087 is a UL181A-P listed foil. This foil product has a more technically sophisticated acrylic adhesive system designed to meet the more stringent demands of UL.

| MARS NO. | DESCRIPTION | SIZE | MARS PACK |
|----------|--------------------|------------------|-----------|
| 79087 | U.L. 181 foil tape | 2 1/2" x 60 yds. | 16 |

Spray Adhesive

MARS #79094 is especially designed to bond polyethylene to itself, concrete block, wood and other hard to bind surfaces. Does not contain methylene chloride. Very quick, aggressive tack. Excellent for HVAC insulation applications.

| MARS NO. | DESCRIPTION | MARS PACK |
|----------|----------------------------|-----------|
| 79094 | Spray adhesive, 17 fl. oz. | 12 |

Liquid Electrical Tape

| MARS NO. | DESCRIPTION | MARS PACK |
|----------|--------------------------------------|-----------|
| 86135 | Liquid electrical tape (black), 4oz. | 1 |

PVC Electrical Tape

PVC electrical tape provides excellent adhesion to aluminum and copper conductors and plastic and rubber insulations where quick identification is most needed. Due to its primary use in low temperatures, it can be stretched to conform to any shape without breaking. UL listed and CSA approved. PVC electrical tape is designed for general splicing and as a protective outer jacket. Flame retardant and cold and weather resistant. UL listed and CSA approved.

| MARS NO. | DESCRIPTION | MARS PACK | CASE QTY. |
|----------|--------------------|-----------|-----------|
| 86186 | 3/4" x 66' - red | 1 | 100 |
| 86187 | 3/4" x 66' - white | 1 | 100 |
| 86188 | 3/4" x 66' - green | 1 | 100 |
| 86189 | 3/4" x 66' - blue | 1 | 100 |
| 86184 | 3/4" x 60' - black | 1 | 100 |
| 86133* | 3/4" x 60' - black | 10 | 100 |

* Non-UL



SERVICE & INSTALLATION

Tapes & Supplies

MARS SERIES **954 & 788**



Low Density Teflon Tape

- Thickness 3 mils.
- Standard grade, low density
- Provides a highly resistant seal on pipe threads for all types of service
- Suitable for use with solvents, chemicals, oxygen, and on food lines
- Non-toxic
- Permits easy disassembly, even after years of service
- Meets Mil. Spec. T-27730A
- Sealing temperature range: -450°F to 550°F (-268°C to 288°C)
- Working pressures: 2,000 PSI (136 BAR)
- Sold in case quantities only

| MARS NO. | DESCRIPTION | MARS PACK | CASE QTY. |
|----------|-------------|-----------|-----------|
| 95409 | 1/2" x 260" | 44 | 144 |
| 95410 | 1/2" x 520" | 44 | 144 |
| 95412 | 3/4" x 520" | 44 | 144 |

High Density Slick-Tite® Teflon Tape

- Thickness 3 mils.
- High density
- Provides a highly resistant seal on pipe threads for all types of service
- Made in USA
- Suitable for use with solvents, chemicals, oxygen, and on food lines
- Non-toxic
- Permits easy disassembly, even after many years
- Meets Mil. Spec. T-27730A
- Sealing temperature range: -450°F to 550°F (-268°C to 288°C)
- Working pressures: 2,000 PSI (136 BAR)

| MARS NO. | DESCRIPTION | MARS PACK | CASE QTY. |
|----------|-------------|-----------|-----------|
| 95525 | 1/4" x 300" | 12 | 12 |
| 95526 | 1/4" x 600" | 12 | 12 |
| 95527 | 1/2" x 300" | 12 | 12 |
| 95528 | 1/2" x 600" | 12 | 12 |
| 95530 | 3/4" x 300" | 12 | 12 |
| 95532 | 1" x 300" | 12 | 12 |

MARS Teflon Tapes

| MARS NO. | DESCRIPTION | MARS PACK |
|----------|---|-----------|
| 78940 | 1/2" x 260" - STD grade white teflon tape | 12 |
| 78941 | 1/2" x 520" - STD grade white teflon tape | 12 |
| 78942 | 1/2 x 260" - hi-density pink teflon tape | 10 |
| 78944 | 1/2" x 260" - hi-density yellow (UL) gas tape | 10 |

LA-CO®

95409



95528



78940





Plews Standard Grease Fitting

Standard grease fittings are precision engineered to withstand rugged use in most automotive and industrial applications. The feature steel fittings with corrosion resistant plated finish and built-in ball check.

The small grease fitting assortments contain the three most popular 1/4"-28 threaded fittings used when making a "change-over" from plugs to fittings. Ideal for the contractor.

Plews small 4-way grease fitting tool (MARS #93385) is for most popular 1/4"-28 and 6 mm fittings. Tap repairs 1/4"-28 threads. Wrench removes 5/16" and 3/8" hex fittings and plugs. Wrench installs new fittings. "Easy-out" removes broken fittings. Large tool (MARS #93384) is designed for 1/8" NPT fittings. Tap repairs 1/8" NPT threads. Wrench removes 7/16" and 3/8" hex fittings and plugs. Wrench installs new fittings. 1/8" NPT "Easy-out" removes broken fittings.

| MARS NO. | DESCRIPTION | MARS PACK | CASE QTY. |
|----------|---|-----------|-----------|
| 93375 | 1/8" npt, short-straight fitting, 100/box | 11-150 | 1 |
| 93376 | 1/8" npt, short-straight fitting, 10/card | 11-151 | 10 |
| 93378 | 1/8" npt, short 45° fitting, 5/card | 11-159 | 10 |
| 93372 | 1/8" npt, short-90° fitting, 5/card | 11-167 | 10 |
| 93388 | 1/4" npt, straight fitting, 5/card | 11-201 | 10 |
| 93383 | 8 assorted grease fitting kit | 11-955 | 10 |
| 93384 | Large 4-way grease fitting tool | 11-901 | 5 |
| 93385 | Small 4-way grease fitting tool | 11-903 | 10 |
| 93386 | 1/4"-28 thread, short-straight fitng, 10/card | 11-101 | 10 |

Standard fitting assortment includes:

| 93383 Qty. | Description | Thread |
|------------|----------------|---------|
| 4 | short-straight | 1/4"-28 |
| 2 | short 45° | 1/4"-28 |
| 2 | short 90° | 1/4"-28 |

Plews Handled And Pistol Oilers

When you reach for an oiler, make sure it's a Plews! Plews oilers are truly the finest in the industry; for either the professional or the handyman. Epoxy finish handled oilers and pistol oilers are made of heavy duty, drawn steel bodies. Durable epoxy finish resists rust. Zinc plated, detachable flex spouts are featured.

| MARS NO. | DESCRIPTION | MARS PACK | CASE QTY. |
|----------|---------------------------------|-----------|-----------|
| 93390 | Pint oiler w/9" flexible spout | 50-337 | 1 |
| 93393 | 6 oz. oiler w/6" flexible spout | 50-516 | 10 |

Plews Plastic Funnels

| MARS NO. | DESCRIPTION | MARS PACK | CASE QTY. |
|----------|--|-----------|-----------|
| 93396 | 5 1/2" utility funnel, 1 pint | 75-062 | 1 |
| 93397 | 7" heavy duty funnel, 2 quart | 75-070 | 1 |
| 93398 | 5 3/4" utility funnel w/screen includes 13" flex extension | 75-007 | 1 |

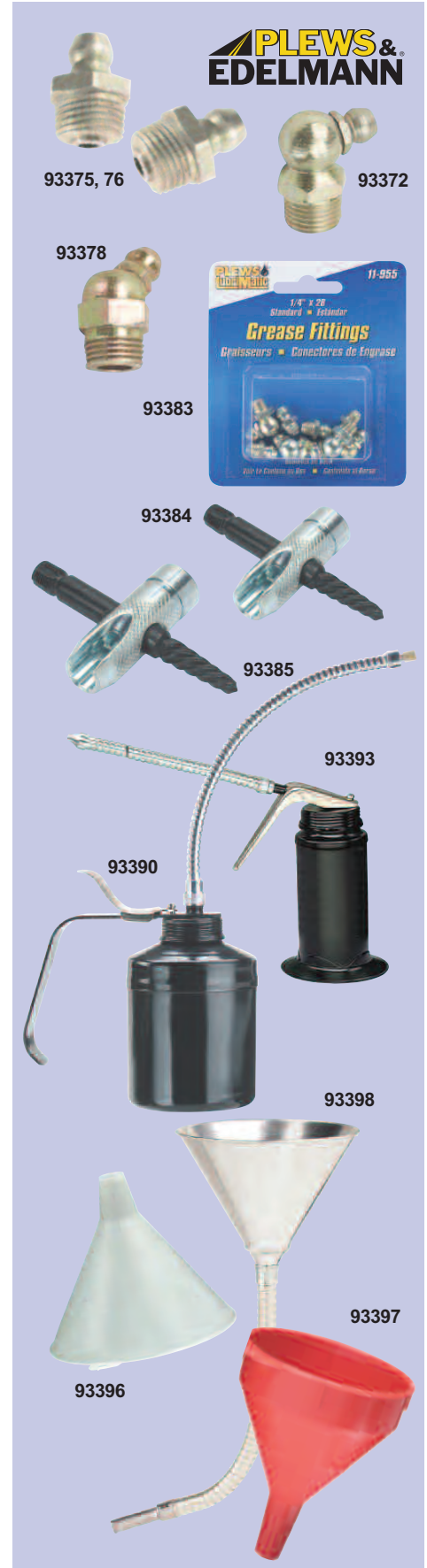

SERVICE & INSTALLATION

Maintenance Products

MARS SERIES **933**



Plews Grease Guns

Plews grease guns allow one hand operation and are perfect for hard to reach jobs. Precision pump develops up to 7000 p.s.i. Easy three-way loading by standard 14 oz. cartridge or suction filled. There is a head cap port for adding air bleeder or bulk loader fitting. Available in two different styles. Both feature tough all-steel construction with rugged baked enamel finish and tough zinc plated handles. New non-slip knurl on barrel allows for positive grip.

The mini grease gun kit is a compact "tool box" size grease gun that goes where other grease guns can't.

Features include:

- Zinc die cast head cap
- Pistol grip for easy one hand operation combined with heavy duty performance
- Uses standard 3 oz. cartridge
- Kit includes gun with rigid pipe and coupler and one 3 oz. multi purpose grease cartridge

MARS #93353 is a general purpose grease gun with professional features. This grease gun offers 2 way loading: 14 oz. cartridge or suction. The lever action gun includes 5-3/8" pipe and coupler. Develops up to 6,000 psi. Durable baked enamel finish.

MARS #93355, professional grease gun features variable/short stroke for easy use in confined areas. This lever action gun provides an air bleeder and bulk loader fitting for 3-way loading (14 oz. cartridge, bulk or suction). Grease gun includes 5-3/8" pipe and coupler. Plated lever with comfortable oversized grip is also featured. Develops up to 10,000 psi.

| MARS NO. | DESCRIPTION | MARS PACK | CASE QTY. |
|----------|------------------------------------|-----------|-----------|
| 93350 | Pistol grease gun, 12" hose | 30-415 | 1 5 |
| 93351 | Pistol grease gun, with pipe ass'y | 30-425 | 1 5 |
| 93352 | Mini grease gun kit, 3 oz. | 30-132 | 1 10 |
| 93353 | Lever action grease gun, 14 oz. | 30-445 | 1 10 |
| 93355 | Professional grease gun, 14 oz. | 30-475 | 1 10 |



Plews Multi Purpose Grease

Plews multi-purpose lithium grease is a long lasting, hard working formula which delivers high performance in a wide range of heavy duty applications. NLG1 #1-1/2, drop point 350° F.

| MARS NO. | DESCRIPTION | MARS PACK | CASE QTY. |
|----------|-------------------------------------|-----------|-----------|
| 93361 | Multi purpose cartridge, 14 oz. | 11-310 | 1 40 |
| 93362 | Multi purpose cartridge, 3 oz./4 pk | 11-300 | 1 10 |

Plews Lubrication Accessories

Plews standard jaw-type couplers feature a spring loaded ball check valve. Fits all 1/8" NPT threads. For all hand operated lube equipment (not for power lubricating equipment).

Recommended working pressure is 3,000 psi. Heavy duty coupler recommended working pressure is 4,000 psi.

For use on hand operated grease guns only, heavy duty hoses have high quality 1/8" NPT male fittings on each end. Recommended working pressure is 3,000 psi. Burst pressure is 12,000 psi. Meets U.S. Government Specification MIL-L-4387C.

| MARS NO. | DESCRIPTION | MARS PACK | CASE QTY. |
|----------|-------------------------------|-----------|-----------|
| 93365 | Standard grease gun coupler | 05-031 | 1 10 |
| 93366 | Heavy duty grease gun coupler | 05-035 | 1 10 |
| 93367 | Heavy duty grease hose, 12" | 10-212 | 1 10 |
| 93369 | Heavy duty grease hose, 18" | 10-219 | 1 10 |

SERVICE & INSTALLATION



Maintenance Products

MARS SERIES **954**

Epoxy-Stik™

- Cures rock hard with no shrinkage
- Safe on portable water systems
- Withstands temperatures up to 250° F
- Hardens in 5-10 minutes, full cure in 24 hours
- Can be applied under water
- After 1 hour can be drilled, tapped, filed, sawed, sanded and painted

| MARS NO. | DESCRIPTION | MARS PACK | CASE QTY. |
|----------|-------------|-----------|-----------|
| 95522* | 4 oz. stick | 24 | 24 |

* Packaged in one dozen per display box

Sharpie® #15 Fiber Tip Marker (Dura-Ink #15)

- Fine tip • Ideal for fine line marking • Extra tough tip, won't spread
- Smear resistant, water resistant
- Marks on metal, wood, cardboard, paper, plastic, glass, etc.
- For identification of parts, layout work, marking cartons and crates
- Meets U.S. Fed. Spec. TT-1-544

| MARS NO. | DESCRIPTION | MARS PACK | CASE QTY. |
|----------|-------------|-----------|-----------|
| 95488 | Black | 12 | 72 |

Valve Action™ Paintmarker

- Marking range: -50° to 150°F / -46° to 66° C • Marks w/ real paint, dries in minutes
- Valve action nib releases paint as needed for continuous marking
- Marks on all surfaces including: metal, wood, glass, plastic, rubber, cardboard and paper • Lead - free, low halogens
- The fiber nib is replaceable to assure complete use of each marker
- Durable metal barrel • Meets California VOC regulations

| MARS NO. | DESCRIPTION | MARS PACK | CASE QTY. |
|----------|-------------|-----------|-----------|
| 95480 | Black | 12 | 48 |
| 95481 | Red | 12 | 48 |
| 95485 | Yellow | 12 | 48 |

Dura-Ink® Fiber Tip Markers

- Larger ink supply, heavy duty metal barrel
- Water - resistant, fade - resistant
- Chisel tip makes fine lines or broad marks
- Meets Fed. Spec. TT-1- 544
- Use on cardboard, wood, metal, paper, ceramics, glass, etc.
- For identification of equipment, marking shipping cartons, sign making, etc.
- #20 is medium size, #25 is king size

| MARS NO. | DESCRIPTION | MARS PACK | CASE QTY. |
|----------|---|-----------|-----------|
| 95500 | Dura - Ink® #25 - black | 12 | 48 |
| 95516 | Markal Dura-Ink #25 Black Marker (2-pk) | 1 | 24 |
| 95519 | Black | 1 | 36 |

Pipe Joint Compound

| MARS NO. | DESCRIPTION | MARS PACK | CASE QTY. |
|----------|---------------------------|-----------|-----------|
| 95432 | Oyltite Stick 1 oz. | 12 | 24 |
| 95433 | Pipertite Stick 1-1/4 oz. | 12 | 144 |



LA-CO®

95522



95488

95485



95500



95432



95433

SERVICE & INSTALLATION



The largest selection of motors, components and accessories for the HVAC/R Industry

SI-133

Maintenance Products

MARS SERIES **954 & 730**



E-Z Break® Anti-Seize Compound

- Copper-based anti-seize and lubricating compound
- Resists rust and corrosion
- Recommended for coating nuts, bolts, valves, flanges, splines, for easy break out after years of service
- Meets Mil. Spec. Mil-A-907E
- Authorized by USDA for use in federally inspected meat and poultry plants
- Temperature: to 1800° F (982° C)

| MARS NO. | DESCRIPTION | MARS PACK | CASE QTY. |
|----------|-------------------|-----------|-----------|
| 95472 | 10 oz. w/brushcap | 24 | 24 |

Pierce® Rust Remover Penetrant

- Drives under rust and penetrates into the tightest crevices to protect against rust and corrosion
- Removes asphalt, tar, grease, dirt from metal surfaces
- Colorless moisture repellent film guards against continuing rust and corrosion
- Use on all equipment tools, chain saws, cables, ignition systems, threaded parts, and any rotating or sliding metal surfaces.
- Lubricates and eliminates squeaks

| MARS NO. | DESCRIPTION | MARS PACK | CASE QTY. |
|----------|----------------------------|-----------|-----------|
| 95423 | 12 oz. aerosol w/extension | 24 | 24 |

Spray Weld

All-in-one cleaner, primer & cement in a handy aerosol can.

- Valve sprays in any angle, even when can is upside down!
- Commercial grade fast-setting, heavy-bodied, CFC's free aerosol propellant
- 11 oz. can yields up to 300 - 3/4" joints. That's over 100 more joints than a quart can of traditional brush-on cement!
- All-weather formula works Hot or Cold, Wet or Dry
- Sets in 1-2 minutes!
- Pressure test to 100 PSI in as little as 30 minutes!

For use on:

SDR 35CL200, Schedules 20, 40 & 80 up to 6" dia.

| MARS NO. | DESCRIPTION | MARS PACK |
|----------|-------------|-----------|
| 73010 | Clear | 12 |
| 73011 | Purple | 12 |

Permatex® Adhesives & Sealants

Permatex® PermaPoxy™ 5 Minute General Purpose Epoxy and 30 Minute High Strength General Purpose Epoxy

- Versatile easy to use, clear appearance, 2 part adhesive and filler system. No need to weld or braze
- Fills gaps and will not shrink
- Temperature range -60°F to 180°F (-51°C to 82°C).
- 5 min. general purpose epoxy - permanent strength up to 3400 PSI
- 30 min high strength - permanent strength up to 3500 PSI

Permatex® Super Glue

This formulation was specially designed for a faster, long-lasting bond. It is easily applied and works on non-porous materials including metal, plastics, rubber, vinyl, paper, wood, textiles, and cork gaskets. Permanent transparent bond fills gaps to .004".

| MARS NO. | DESCRIPTION | MARS PACK | CASE QTY. |
|----------|--------------------------------------|-----------|-----------|
| 95555 | 5 Min Epoxy, .84 fl oz | 12 | 12 |
| 95556 | 30 Min Epoxy, .84 fl oz dual syringe | 12 | 12 |
| 95557 | Super Glue Gel tube, 2 grams | 12 | 12 |
| 95558 | Super Glue tube, 2 grams | 12 | 12 |



SERVICE & INSTALLATION



CRC Lubricants

CRC products incorporate the **MSD(L)**™, a removable material safety data sheet printed on the reverse side of the label. With this new labeling system, a MSDS is always where you need it the most, right on the product you are using!

CRC 3-36 is a multi purpose lubricant and penetrant that forms a clear film that lubricates and stops corrosion. Its high affinity for metal allows it to penetrate and displace moisture leaving a long lasting rust preventing film. Available in aerosol with a nonflammable CO2 propellant and 360° valve.

CRC Screwloose® Penetrating Oil is a no compromise penetrant that attacks rust and corrosion, penetrating through oxides and soil to free corroded fasteners and mechanical components.

CRC Power Lube® is a unique new lubricant that incorporates a sophisticated additives package with Teflon® to provide long lasting protection against friction and wear. It is able to work longer and better than other lubricants under the extremes of pressure and the environment. Unlike most lubricants with Teflon®, it contains no chlorinated solvents.

CRC Cutting Oil is a superior thread cutting lubricant for use on all types of metal. The low odor formula is safe for soft metals such as brass and aluminum, and is non-staining. The same formula is also used for steel and galvanized metal, and cuts without that strong sulphur smell. Aerosol formulation with viscosity improved for increased cling, and reduces waste.

CRC White Lithium grease with Teflon® is a high purity, high quality grade 2 white lithium based grease with an additive package that includes Teflon® for superior lubrication. It is truly white, smooth and buttery in consistency for optimum surface coverage. It has both rust and oxidation inhibitors to provide durable lubrication and protection in any application.

| MARS NO. | DESCRIPTION | MARS PACK |
|----------|--------------------------------------|-----------|
| 93208 | 3-36 Multi Purpose Lubricant, 11 oz. | 12 |
| 93211 | Screwloose® Penetrating Oil, 11 oz. | 12 |
| 93212 | Power Lube® Teflon Lubricant, 11 oz. | 12 |
| 93213 | Cutting Oil, 12 oz. | 12 |
| 93214 | White Lithium Grease, 10 oz. | 12 |
| 93284 | 2-26 Lubricant, 11 oz. | 12 |

CRC Specialty Products

The Wasp and Hornet Killer Plus™ is a fast acting, high strength insecticide that kills wasps, hornets, black widow spiders, fire ants and scorpions. Will not damage plastic connectors and other insulating materials. Provides a dense accurate spray that will reach over 20 feet. Excellent for the A/C contractor.

HydroForce™ Glass Cleaner Professional Strength is formulated to clean streak-free – the first time and every time. The ammonia-fortified formula quickly cleans the toughest dirt, dust, fingerprint and haze deposits without leaving unsightly streaks due to residue. HydroForce™ is versatile and safe to use on all glass surfaces. The foaming, ready-to-use formula allows for greater coverage and less run-off when cleaning vertical surfaces. HydroForce™ is biodegradable, non-corrosive, non-flammable and non-abrasive. Let us prove it to you.

CRC Rubberized Spray Undercoating is a specially formulated rubberized product that dries quickly and is exceptionally resistant to abrasion, rust and corrosion. Seals underbody, fender, panels, frame, hood, doors, weld joints, etc., against moisture, salt and road debris.

Ask your MARS representative for information on how to become a full line CRC distributor and also for details on additional CRC problem solving products.

| MARS NO. | DESCRIPTION | MARS PACK |
|----------|---------------------------------------|-----------|
| 93226 | Wasp and Hornet Killer Plus™, 14 oz. | 12 |
| 93227 | HydroForce Glass Cleaner, 18 oz. | 12 |
| 93233 | Rubberized spray undercoating, 16 oz. | 12 |



SERVICE & INSTALLATION

Maintenance Products

MARS SERIES **931**



CRC Cleaners/Degreasers

CRC Heavy Duty Degreaser is a chlorinated solvent based cleaner/degreaser that is chemically stable and extremely effective in most heavy duty applications. It has no fire or flash point, evaporates quickly with no residue and is non-conductive. New formula contains no ozone depleting compounds. Effectively removes grease, tar, oil, adhesives, etc. to increase operating efficiency.

CRC Industrial Contact Cleaner is designed to quickly and effectively clean sensitive electrical and electronic components. It has no flash point and evaporates quickly, leaving no residue. Contains no CFC's or VOC's

CRC QD Contact Cleaner is an alcohol based precision cleaner that is **100% free of CFC's**. For use on non-energized equipment, it evaporates rapidly and is harmless to most plastics. For use on electrical and electronic components where precision cleaning is necessary.

The CRC Contact Cleaner 2000™ is a revolutionary precision cleaning solvent designed to meet today's environmental challenges. This high purity solvent is a new generation HCFC and does not exhibit the same ozone depleting properties as conventional CFC solvents. It evaporates rapidly, has no flash point and leaves no residue (may affect some plastics).

CRC Gasket Remover is a solvent based high strength cleaner that effectively loosens and helps remove fiber gaskets, adhesives and sealants. It helps protect equipment surfaces by eliminating damage caused by scraping. Also removes paint and graffiti.

SERVICE & INSTALLATION

| MARS NO. | DESCRIPTION | MARS PACK |
|----------|------------------------------------|-----------|
| 93215 | Heavy Duty Degreaser, 19 oz. | 12 |
| 93217 | Industrial Contact Cleaner, 14 oz. | 12 |
| 93218 | QD Contact Cleaner, 11 oz. | 12 |
| 93219 | Contact Cleaner 2000™, 14 oz. | 12 |
| 93222 | Gasket Remover, 12 oz. | 12 |
| 93294 | Lectra Clean | 12 |





Maintenance Products

MARS SERIES **932 & 790**

CRC Food Grade Silicone

CRC Food Grade Silicone forms a colorless, tasteless, non-toxic and non-staining film that is authorized by the USDA for use in federally inspected meat and poultry plants. Its silicone lubrication film meets FDA specifications for incidental food contact.

| MARS NO. | DESCRIPTION | MARS PACK |
|----------|-----------------------------|-----------|
| 93210 | Food Grade Silicone, 10 oz. | 12 |

CRC RTV Silicone

CRC RTV Silicone Adhesive/Sealants are the perfect way to seal, bond and protect. With the press of the nozzle, a precise bead of high purity silicone is easily applied. No lumps, gaps, bubbles or waste. The package keeps the silicone fresh with the product in the nozzle forming a self sealing plug. Convenient and easy to use.

| MARS NO. | DESCRIPTION | MARS PACK |
|----------|-------------|-----------|
| 93236 | 8 oz. clear | 12 |

CRC Corrosion Inhibitors

CRC Zinc-It® Instant Cold Galvanize is a high performance 95% zinc-rich coating that restores hot dipped galvanized properties to ferrous metals. Its sacrificial coating helps fight rust and corrosion creepage with a durable, flexible film.

CRC Belt Dressing extends the life of drive belts by improving traction and allowing runs under reduced belt tension. Formulated with a synthetic polymer that is non-drying, water resistant and chemically stable. It also meets FDA regulations for incidental food contact.

| MARS NO. | DESCRIPTION | MARS PACK |
|----------|-----------------------|-----------|
| 93223 | Zinc-It®, 13 oz. | 12 |
| 93224 | Belt Dressing, 10 oz. | 12 |

Industrial All Purpose Spray Enamel

Krylon TOUGH COAT® acrylic alkyd enamels feature a high-solids formula that ensures maximum coverage and performance. Tough Coat delivers the ultimate in protection, durability, high gloss, color retention and applies with a smooth even coverage. Fast-drying to the touch in 15 minutes. Ideal for light to heavy duty painting projects both indoors & outdoors.

| MARS NO. | DESCRIPTION | REFRIG. ID # | CASE QTY. |
|----------|----------------------|--------------|-----------|
| 78976 | Machinery light gray | R-23 | 6 |
| 78987 | Machinery dark gray | R-123 | 6 |
| 78981 | OSHA white (gloss) | R-12, R-406A | 6 |
| 78982 | White (flat) | | 6 |
| 78983 | OSHA black (gloss) | | 6 |
| 78984 | Black (flat) | | 6 |
| 78985 | Aluminum | | 6 |

Reflect-All™ All Purpose Spray Coating

Reflect-All™ is a revolutionary light-reflective paint that can be applied to virtually any surface. The reflective microbeads capture, intensify and reflect light back to the source resulting in amazing nighttime visibility.

Reflect-All™ has unlimited applications. Wherever low-light or nighttime safety is a must, Reflect-All™ is your brilliant answer!

Goes on semi-transparent and dries in 10 minutes.

| MARS NO. | DESCRIPTION | MARS PACK |
|----------|---------------------|-----------|
| 78995 | Reflect-All™ 12 oz. | 6 |



SERVICE & INSTALLATION

Pipeseal

MARS SERIES **934**



Pipeseal

Pipeseal is a unique multi-component epoxy designed to quickly and permanently patch, seal and repair cracks, holes and leaks in all types of pipe.

Seals Holes in Pipe to Full Pressure in Under Five Minutes!

- Works on all types of pipes including copper, steel, lead, cast iron and aluminum.
- Heat activated - Hardens fully in less than 1 minute.
- Withstands pressures up to 1200psi.
- No wrap/plug required.
- Suitable for refrigerant lines.
- Extreme chemical resistance
- 100% solids - No VOCs
- Permanently seals holes of up to 1/4 in. in diameter.

INSTRUCTIONS:

- 1** Prepare Surface around pipe hole/crack with sand paper or file.
- 2** Remove clip and cut-off the end with the clear material and apply entire content to mixing surface; ensure mixing surface is not porous.
- 3** Thoroughly mix entire contents.
- 4** Apply to pipe with a wooden stick or trowel.
- 5** Cover a 2-inch-wide area around pipe hole/crack.
- 6** Apply heat with a heat gun/hair dryer (approx. 140°) until Pipeseal cures and hardens (usually within 1minute).

| MARS NO. | DESCRIPTION | MARS PACK | CASE QTY. |
|----------|-------------|-----------|-----------|
| 93629 | Pipeseal | 1 | 12 |



Sprayers & Garden Hoses

MARS SERIES **797 & 790**



Chapin Sprayers & Accessories

MARS #79067, 2 gallon (1.5 gallon usable) polyethylene sprayer is a high density sprayer that resists breaking, leaking and chemical corrosion. This sprayer has a polymer shut off with lock on feature and a polymer nozzle that adjusts from fine spray to 30' stream, with a poly/brass extension that rotates 360°. Reinforced 36" hose resists crimping, cracking and leaking.

The Chapin acid sprayer is the ideal sprayer for cleaning and degreasing air conditioning coils, engines and many other uses. This 2 gallon (1.5 gallon usable) heavy-duty polyethylene tank features a new built-in relief valve/pressure gauge for added safety and polymer shut offs with lock off features to prevent accidental spraying. A 12" extension tube with adjustable poly cone nozzle ensures for better control when spraying chemically active liquids. Sprays coarse stream to fine mist. 42" hose included

MARS #79069, hand held pressure sprayer is a 48 oz. multi purpose sprayer for small areas. Heavy duty, chemical resistant poly tank features adjustable nozzle control for fine mist or straight stream spraying.

| MARS NO. | DESCRIPTION | MARS PACK | CASE QTY. |
|----------|-------------------------------|-----------|-----------|
| 79067 | 2 gallon polyethylene sprayer | 1 | 1 |
| 79068 | 2 gallon acid sprayer | 1 | 1 |
| 79069 | 48 oz. hand held sprayer | 1 | 1 |

Swan Garden Hoses

Fairlawn® reinforced garden hose combines excellent quality and good value. This light duty, three-ply strength hose offers good pressure capacity and is flexible for easy handling. Solid brass couplings. Two year warranty.

MARS #79539 and 79540, premium rubber hose, provide superior flexibility and pressure capacity. Maximum kink resistance and burst strength make this hose very durable. Handles hot water up to 160°F. Seal-tite™ washerless leakproof coupling. Lifetime warranty.

The professional hot water hose is designed for a wide range of applications requiring hot water use up to 200°F. The heavy duty rubber construction offers maximum wear and abrasion resistance. Industrial style reinforcing for high burst pressure and kink resistant. Seal-tite™ washerless leakproof coupling. All hoses are made in the U.S.A.

MARS #79641 and 79642, WeatherFlex® Hose is an all-weather reinforced garden hose with its popular mint green Clear Tough™ jacket. Its medium duty construction makes it perfect in all seasons by staying pliable in cold weather. Comes with Eco couplings and patented Hose Armour™ to prevent kinking at the spigot.

| MARS NO. | DESCRIPTION | MARS PACK | CASE QTY. |
|----------|-------------------------------|-----------|-----------|
| 79538 | Fairlawn® - 5/8" x 50' | 1 | 5 |
| 79539 | Premium rubber - 5/8" x 25' | 1 | 5 |
| 79540 | Premium rubber - 5/8" x 50' | 1 | 5 |
| 79541 | Hot water rubber - 5/8" x 25' | 1 | 5 |
| 79542 | Hot water rubber - 5/8" x 50' | 1 | 5 |
| 79641 | All weather - 5/8" x 50' | 1 | 5 |
| 79642 | All weather - 5/8" x 75' | 1 | 5 |

Gilmour Full Size Pistol Grip Nozzles

| MARS NO. | DESCRIPTION | MARS PACK | CASE QTY. |
|----------|--------------------------------------|-----------|-----------|
| 79581 | Insulated chrome plated | 1 | 24 |
| 79582 | Insulated threaded front | 1 | 24 |
| 79583 | Vinyl cushioned grip | 1 | 24 |
| 79584 | Metalized threaded front | 1 | 48 |
| 79560 | Hose washers, fits 5/8" hoses, 20/pk | 1 | 1 |



| Features of Gilmour® Pistol Grip Nozzles | | | | |
|---|--------------------------|--------------------------------------|---------------------------|---------------------|
| | 79581 | 79582 | 79583 | 79584 |
| Nozzle features | chrome plated, full-size | chrome plated, full-size | metal full-size | metalized full-size |
| All brass valve stem with permanent adjusting nut on all | | | | |
| Hold-open clip on all | | | | |
| Patented, insul. grip & industrial strength lever | yes | yes | no | no |
| Unique features | brass head insert | rubber head guard, brass head insert | vinyl molded comfort grip | |
| Stainless steel spring on all | | | | |
| Lifetime duck packing seal on all | | | | |
| Male hose threaded for attaching accessories | no | yes | yes | yes |
| Pack carded on all | | | | |

SERVICE & INSTALLATION

Custom Leather Craft Products

MARS SERIES **790**



Custom Leather Craft Products

Professional contractors require professional tools and accessories. Carrying a CLC Softside Tool Carrier is like owning a workshop to go. Loads of pockets, rugged polyester fabric, reinforced bottom panels, heavy duty stitching and bar tacking at critical stress points are features that make CLC a requested brand.

| MARS NO. | DESCRIPTION | MARS PACK |
|----------|--|-----------|
| 79279 | 28 Pocket Tool Pouch <ul style="list-style-type: none"> 7" x 5-1/2" multi compartment tray slides into bottom of pouch Box shaped design prevents tipping Padded carrying handle and adjustable shoulder strap 8"L x 8"W x 17"H | 1 |
| 79280 | 15 Pocket, 16" Center Tray Tool Bag <ul style="list-style-type: none"> 13-1/2" x 9" multi compartment tray stores in middle of bag 8 pockets outside and 7 pockets inside Padded carrying handle and adjustable shoulder strap 16"L x 9"W x 9"H | 1 |
| 79281 | 4 Pocket Tool Holder <ul style="list-style-type: none"> Hang, strap, or clip on workbelts, suspenders, or pants Securely holds small tools or accessories | 1 |
| 79282 | 23 Pocket Large Tool Carrier <ul style="list-style-type: none"> 11" x 6" multi compartment plastic tray that slides into the bottom of the carrier 16 multi use outside pockets and 7 inside to organize tools & accessories Box shaped design prevents tipping 11"L x 10"W x 19"H | 1 |
| 79283 | 26 Pocket Backpack Bag <ul style="list-style-type: none"> 20 inside and 6 outside pockets organize a variety of tools & accessories Exclusive Tools-In-A-Row system folds open, then open again to layout your most used tools Padded adjustable shoulder straps | 1 |
| 79285 | Mini Cell Phone Holder <ul style="list-style-type: none"> Specially designed to securely hold newer and smaller cell phones Versatile 2-way attachment for belt pants, etc. Elastic side panels and inside padding for protection | 1 |
| 79286 | Large Cell Phone Holder <ul style="list-style-type: none"> Hang, strap, clip onto workbelts, suspenders, and pants Holds most brands of large cell phones Elastic side pockets for pens, pencils, small tools, etc. | 1 |
| 79287 | Plastic Cap Swivel Kneepads <ul style="list-style-type: none"> One size fits all Exclusive grooved cap design prevents thread abrasion Foam padded with easy on/off hook and loop fasteners | 1 |
| 79270 | Ultraflex® Non-Skid Professional Kneepads <ul style="list-style-type: none"> One size fits all Upper cap design for all day comfort and protection Soft, flexible outer shell protects and grips most surfaces without scratching or scuffing Slot n dot strap connections, Memory Flex™ synthetic rubber straps | 1 |
| 79288 | Work Crew Gloves-L | 1 |
| 79289 | Work Crew Gloves-XL <ul style="list-style-type: none"> Synthetic leather palm is tough, soft, and comfortable Lycra side panels provide flexibility Spandex back ensures snug fit | 1 |





Custom Leather Craft Products

MARS SERIES **790**

| MARS NO. | DESCRIPTION | MARS PACK |
|----------|---|-----------|
| 79263 | 14 Pocket Large Traytote Bag <ul style="list-style-type: none"> • 2 Pockets inside, 12 outside • 13 1/2" x 6" multi-compartment plastic tray included, slides securely into bottom of bag. • 16"L x 9"W x 12"H | 1 |
| 79290 | Work Right OC™-M | 1 |
| 79291 | Work Right OC™-L | 1 |
| 79292 | Work Right OC™-XL <ul style="list-style-type: none"> • Padded synthetic palm material is soft and comfortable • Open cuff design with textured pull-on tab for easy-on, easy off • Textured fingertip pads provide added abrasion resistance • Padded knuckles for protection against bumps • Stretch spandex back for flexibility and fit | 1 |
| 79264 | Tradesmen High Dexterity Gloves-M (pair) <ul style="list-style-type: none"> • Clarino® synthetic leather is tough, soft and comfortable to wear, resists shrinking, stretching and hardening • Flexible neoprene wrist cuff keeps debris out • Flex-Spot™ thumb design for better flexibility • Stretch spandex for flexibility and fit • Padded knuckles provide protection against bumps | 1 |
| 79265 | Tradesmen High Dexterity Gloves-L (pair) | 1 |
| 79266 | Tradesmen High Dexterity Gloves-XL (pair) | 1 |
| 79267 | Mossy Oak® 16" Bigmouth® Bag <ul style="list-style-type: none"> • 12 Multi-use pockets inside and 10 outside to organize tools and accessories • Heavy duty stitching and bar tacking at all stress points • 16"L x 8.5"W x 10"H | 1 |
| 79268 | Mossy Oak® 12" Bigmouth Bag <ul style="list-style-type: none"> • 17 Multi-use pockets inside and 6 outside to organize and accessories • Opens wide for easy access to bags contents • Adjustable shoulder strap and padded reinforced web carrying handles • 12"L x 8.5"W x 8"H | 1 |
| 79269 | 48 Pocket Bucket Pockets <ul style="list-style-type: none"> • 14 Double row pockets inside and 34 triple row outside to organize a wide range of tools and accessories • Security pocket with hook and loop closure • Drill pocket with hook and loop handle strap • Designed to fit most 3 1/2 - 5 gallon buckets • Measuring tape strap and key clip included | 1 |
| 79276 | 50 Pocket Double Zipper Tote Bag <ul style="list-style-type: none"> • 9 Multi-use pockets inside and 41 outside to organize tools and accessories • Double pull zipper for easy access • Padded bottom will not scratch, mar countertops, floors and upholstery like metal tool boxes • 18"L x 6"W x 9"H | 1 |
| 79277 | 75 Pocket-Tool Backpack <ul style="list-style-type: none"> • 7"x 5" multi compartment plastic tray included • Adjustable padded shoulder straps and carry handles • 13"W x 17-1/2"H x 9"D | 1 |
| 79284 | 5 Pocket Cell Phone <ul style="list-style-type: none"> • The cell phone, tool and accessory holder you can HANG - STRAP - CLIP on workbelts, web suspenders, pants, etc. • Holds most brands of compact cell phones • Securely holds small tools and accessories like pliers, mini-flashlight, screwdrivers, multi-tools, etc. • Versatile 3-way attachment for pants, web suspenders, work aprons, etc. | 24 |

"Tools Not Included"



SERVICE & INSTALLATION



The largest selection of motors, components and accessories for the HVAC/R Industry

Tool Boxes & Organizers

MARS SERIES **790**



Tool Boxes

All Plano tool boxes and stowaway boxes are constructed of premium quality impact resistant plastics. Solid brass hardware and sturdy ABS drawbolt type latches, withstands rugged wear. All boxes are made in the U.S.A. and have a lifetime warranty!

The Plano Tote-More®, MARS #79368, features a multi compartment drawer and convenient handle for portability. Open top for easy access. Unit measures 14 3/4" L x 9 1/8" W x 6 7/8" H.

| MARS NO. | DESCRIPTION | MARS PACK |
|----------|--------------------------------|-----------|
| 79368 | Tote More® w/draw - gray/black | 4 |

Plano Tool Boxes

| MARS NO. | DESCRIPTION | MARS PACK |
|----------|---|-----------|
| 79643 | Clear StowAway 18 Fixed Compartments, 11.13" x 7.94" x 11.63" | 6 |
| 79644 | Clear StowAway - 5 to 9 Adj. Compt. Pro-Latch, 1' Deep Storage, 8.38"x5.38"x 9.88" | 6 |
| 79645 | Graphite Gray & Black 16" Tool Box with bulk storage space and tray, Removable StowAway Organizer built into the top, 19.38" x 16" x 16.63" | 4 |
| 79646 | Graphite Gray & Black 20" tool box with bulk storage space and tray, Heavy Duty handle, 22.38" x 20.69" x 19" | 4 |
| 79647 | Graphite Gray & Iron Yellow 22" tool box with extra deep storage space and tray, 21.88"x12.75"x13.75" | 1 |

Stowaways - Plastic

MARS stowaway boxes are ideal for the professionals or do it yourselfers. These utility boxes hold bolts, screws, washers, bits, solderless terminals and many other small items. MARS #79378 has 6-18 adjustable compartments and measures 11" L x 7 1/4"W x 1 3/4"H. MARS #79379 has 4-24 adjustable compartments and measures 13 3/4"L x 9 1/8"W x 2"H.

| MARS NO. | DESCRIPTION | MARS PACK |
|----------|---|-----------|
| 79378 | 6-18 adj. stowaway box - translucent gray | 6 |
| 79379 | 4-24 adjustable stowaway box - translucent gray | 6 |

Storage Bins

- Heavy duty bins securely stack on top of each other, sit on shelving and hang from racks, panels, rails and carts
- Anti slide stop prevents stacked bins from shifting forward
- Guaranteed not to crack or break under normal load conditions
- Sturdy one piece construction is water, rust and corrosion proof.
- Large front label are for easy coding and scanning
- Curved bottom hopper makes it easy to retrieve small parts

| MARS NO. | DESCRIPTION | MARS PACK |
|----------|--|-----------|
| 79764 | 12" Blue Shelf Bin 11 5/8" L x 4 1/8" W x 4" H | 24 |
| 79765 | 12" Blue Shelf Bin 11 5/8" L x 6 5/8" W x 4" H | 12 |
| 79766 | 12" Blue Shelf Bin 11 5/8" L x 8 3/8" W x 4" H | 12 |

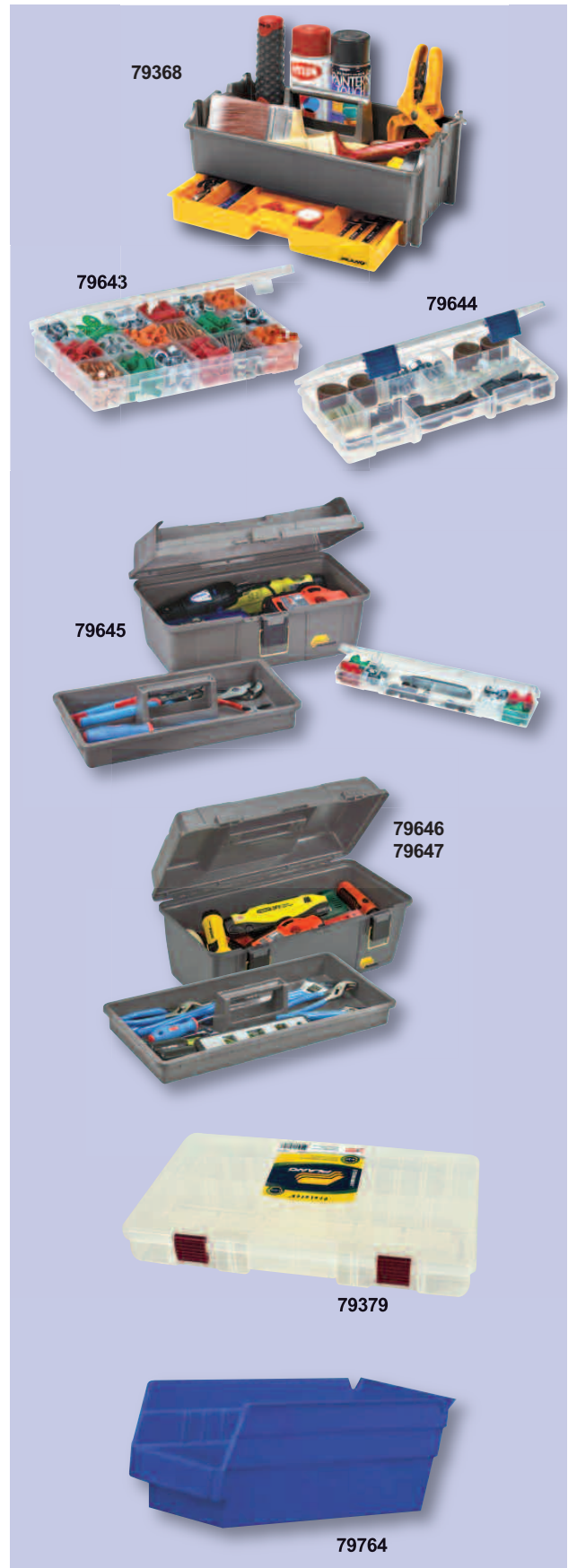

SERVICE & INSTALLATION



Clipboards & Formholders

MARS SERIES **790**

MARS Clipboards And Formholders

MARS aluminum Style A Formholder is versatile, efficient and easy to use. It can be used by both left and right handed people and will accommodate forms ruled either lengthwise or across the width. The storage compartment below keeps completed forms dry and protected.

The MARS Snapaks are very popular aluminum formholders that accommodate loose forms or sales books. Unit opens like a book. Clipboard is included on inside front cover. A hinged aluminum strap on inside back cover holds copies or sales books securely in place. The entire holder folds into a compact protective box to keep forms safe and dry.

The MARS #79558 Redi-Rite is a clipboard on a box. This is the holder to have when you need to carry many forms. Extra storage capacity. All aluminum construction.

MARS #79559 Portfolio is simple yet functional. The cover is hinged on the left with a light spring action so it stays open and stays shut. Paper will stay safe under cover from wind, rain and dirt. Aluminum construction.

| MARS NO. | DESCRIPTION | CASE QTY. |
|----------|-----------------------------|-----------|
| 79552 | "A" formholder 8-1/2" x 12" | 12 |
| 79555 | Snapak 8-1/2" x 12" | 12 |
| 79558 | Redi-Rite 8-1/2" x 12" | 6 |
| 79559 | Portfolio 8-1/2" x 12" | 12 |



"A" Formholder



Snapak



Redi-Rite

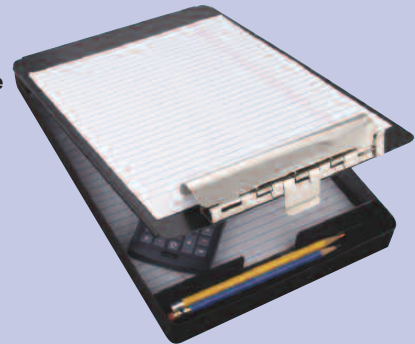

Portfolio

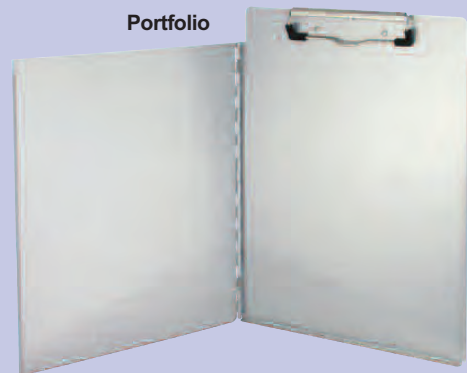

SERVICE & INSTALLATION

HVAC/R Textbooks

MARS SERIES **790**



SERVICE & INSTALLATION

Reference Textbooks

Motors & Armatures is pleased to offer textbooks for the HVAC/R and electrical professionals.

Modern Refrigeration and Air Conditioning is the leader in the refrigeration and air conditioning field! It teaches fundamental principles and service techniques. The text tells and shows how to diagnose and remedy HVAC problems. It provides an excellent blend of theory with job-qualifying skills. Fully covers the practical application of refrigeration in all its branches including: Domestic, Commercial, Air Conditioning, Heat Pumps, Automotive Air Conditioning, Thermoelectric, Solar Energy, and Special Devices. Includes up-to-date information on refrigerant recovery, recycling, and reclaiming.

Emphasizing practical skills and presenting complete, up-to-date information, **Heating and Cooling Essentials** is the ideal introductory book for individuals who plan to enter the HVAC field. Special attention is paid to skills essential to the new technician, such as the familiarity with tools, materials, and fasteners; the ability to read dimensions and perform other math-related activities; and the ability to perform installation, service, and repair techniques. **Heating and Cooling Essentials** provides the new technician with a thorough discussion on temperature/pressure relationships, refrigerants (including the new ones that are replacing CFCs) and refrigerant recycling, valves and flow controls, compressors, HVAC electrical systems and components, major types of heating systems (including heat pumps), and the vital topic of customer relations.

Doolin's Trouble Shooters Bible is used by technicians and contractors everywhere. Partial contents include: electric motors, heat pumps, ice machines, gas and electric heating, central systems, servicing of commercial equipment, basic refrigeration and basic electricity. This reference book is available in a spanish edition as well.

| MARS NO. | DESCRIPTION | MARS PACK | CASE QTY. |
|----------|---|-----------|-----------|
| 78701 | Modern refrigeration & A/C | 1 | 8 |
| 78702 | Heating & cooling essentials | 1 | 10 |
| 78710 | Doolin's trouble shooters bible | 1 | 22 |
| 78711 | Doolin's trouble shooters spanish edition | 1 | 22 |

HVAC Professional Reference Books

DeWalt HVAC Technician Certification Exam Guide MARS # 78725

This comprehensive exam study guide for electricians can be utilized in every state. Based on the 2005 NEC, this book is ideal for preparing to take any one of the licensing exams currently required in the electrical industry. This book includes realistic sample exams with answer keys.

DeWalt HVAC/R Professional Reference-Master Edition MARS # 78726

This expanded edition contains approx. twice as much info as the earlier edition. This comprehensive jobsite solution for HVAC/R technicians covers formulas, design data, heating, ventilation, piping, service, troubleshooting, electrical motors & much more.

DeWalt HVAC Estimating Professional Reference MARS # 78727

This professional reference guide is the ideal pocket tool for any mechanical estimator. This book guides you through each step of the HVAC bidding process; includes checklist, worksheets, forms and more.

| MARS NO. | DESCRIPTION |
|----------|---|
| 78725 | DeWalt HVAC Technician Certification Exam Guide |
| 78726 | DeWalt HVAC/R Professional Reference-Master Edition |
| 78727 | DeWalt HVAC Estimating Professional Reference |

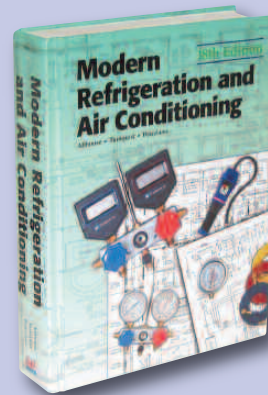

78701



78702



78710



78725

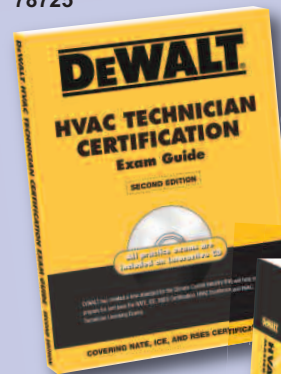

78726



78727