

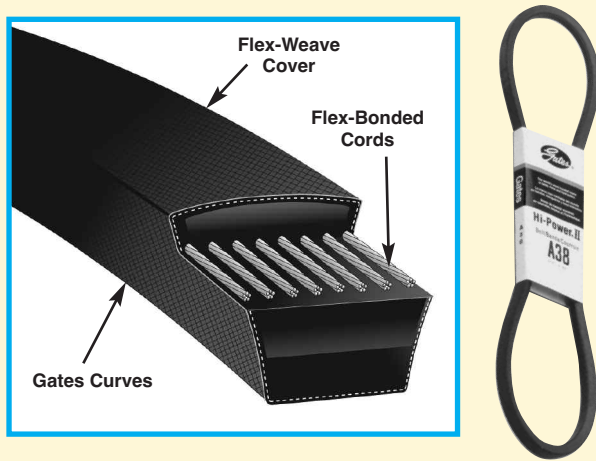

Gates V-Belts

MARS SERIES **741**



Gates Hi-Power® II Belts

Gates Hi-Power II belts are engineered for classical applications. They have patented concave sidewalls to distribute wear evenly while providing proper belt support for improved service life. Flex-bonded cords and flex-weave covers make them the No. 1 choice for heavy-duty conventional V-belt drives. Hi-Power II belts also resist the effects of oil, heat, ozone, weather and aging while meeting RMA standards for static conductivity.

Features & Benefits:

- See page AM-32
- MARS Pack 1

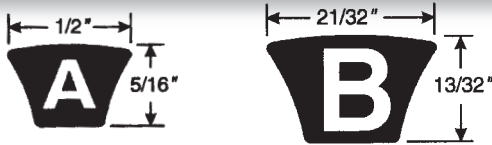

MARS NO.	Desc.	Case Qty.	MARS NO.	Desc.	Case Qty.	MARS NO.	Desc.	Case Qty.	MARS NO.	Desc.	Case Qty.	MARS NO.	Desc.	Case Qty.
A BELTS			A BELTS cont.			A BELTS cont.			B BELTS cont.			B BELTS cont.		
74328	A24	185	74368	A62	50	74404	A103	50	74443	B51	40	74481	B89	30
74329	A25	185	74369	A63	50	74405	A105	25	74444	B52	40	74482	B90	30
74330	A26	150	74370	A64	50	74406	A110	5	74445	B53	40	74528	B91	25
74331	A27	150	74371	A65	75	74407	A112	45	74446	B54	40	74483	B92	30
74332	A28	150	74372	A66	75	74408	A120	35	74447	B55	30	74484	B93	30
74333	A29	150	74373	A67	75	74409	A128	35	74448	B56	20	74485	B94	30
74334	A30	150	74374	A68	50	74410	A133	2	74449	B57	40	74486	B95	30
74335	A31	150	74375	A69	7	74411	A136	2	74450	B58	35	74487	B96	30
74336	A32	150	74376	A70	42	74412	A144	15	74451	B59	35	74488	B97	30
74337	A33	150	74377	A71	75	74416	A158	2	74452	B60	35	74489	B98	5
74338	A34	150	74378	A72	75	74417	A173	2	74453	B61	35	74490	B99	15
74339	A35	130	74379	A73	75	74415	A180	2	74454	B62	35	74491	B100	30
74340	A36	130	74380	A74	42	B BELTS			74455	B63	35	74519	B101	30
74341	A37	110	74381	A75	75	74517	B28	10	74456	B64	35	74520	B102	30
74342	A38	110	74382	A76	75	74526	B280	2	74457	B65	35	74492	B103	30
74343	A39	110	74383	A77	75	74518	B29	95	74458	B66	35	74493	B105	30
74344	A40	110	74384	A78	75	74517	B28	10	74459	B67	25	74494	B106	30
74345	A41	90	74385	A79	50	74422	B30	20	74460	B68	25	74495	B108	30
74346	A42	90	74386	A80	75	74423	B31	95	74461	B69	25	74530	B109	25
74347	A43	90	74387	A81	25	74424	B32	10	74462	B70	20	74496	B110	25
74348	A44	90	74388	A82	50	74425	B33	10	74463	B71	25	74497	B112	15
74349	A45	90	74389	A83	60	74426	B34	25	74464	B72	25	74521	B114	30
74350	A46	90	74390	A84	25	74427	B35	100	74465	B73	35	74498	B115	30
74351	A47	90	74391	A85	50	74428	B36	25	74466	B74	35	74499	B116	30
74352	A48	90	74392	A86	10	74429	B37	20	74467	B75	35	74500	B118	30
74353	A49	90	74393	A87	10	74430	B38	90	74468	B76	35	74501	B120	30
74354	A50	90	74394	A88	30	74431	B39	20	74469	B77	35	74529	B122	5
74355	A51	90	74395	A89	60	74432	B40	75	74470	B78	35	74502	B124	30
74356	A52	50	74396	A90	60	74433	B41	75	74471	B79	35	74503	B126	35
74357	A53	50	74397	A91	60	74434	B42	75	74472	B80	35	74504	B128	30
74358	A54	50	74398	A92	60	74435	B43	75	74473	B81	35	74505	B131	20
74359	A55	50	74399	A93	60	74436	B44	75	74474	B82	30	74525	B133	20
74360	A56	50	74400	A94	60	74437	B45	75	74475	B83	30	74506	B136	20
74361	A57	50	74401	A95	60	74438	B46	65	74476	B84	30	74507	B140	20
74362	A58	50	74402	A96	50	74439	B47	60	74477	B85	35	74522	B142	20
74363	A59	50	74531	A97	5	74440	B48	60	74478	B86	30	74508	B144	20
74366	A60	50	74532	A98	4	74441	B49	60	74479	B87	25	74510	B150	15
74367	A61	50	74403	A100	35	74442	B50	40	74480	B88	20	74511	B154	2



The largest selection of motors, components and accessories for the HVAC/R Industry

AM-31

AIR MARS

Gates V-Belts

MARS SERIES **741**



Gates Truflex® V-Belts

GatesTruflex® belts offer improved performance on light duty, fractional horsepower (FHP) V-belt drives. Their unique patented construction provides smooth, quiet operation with less vibration.

Features & Benefits:

- Gates Curves provide proper cord support and full contact with the sheave-groove for uniform loading, uniform wear, and increased belt life.
- Flex-Bonded Cords are strongly bonded to the body of the belt resulting in equal load distribution and the absorption of bending stress without cord reduction.
- Flex-Weave® Cover is a patented fabric construction for longer cover life, providing extended protection to the belt core from oil, dirt and heat.
- Meets RMA static conductivity requirements.
- Meets RMA oil and heat resistant standards.
- MARS Pack 1

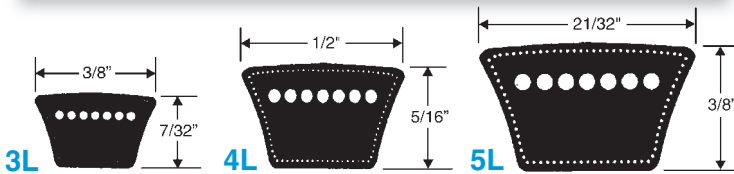
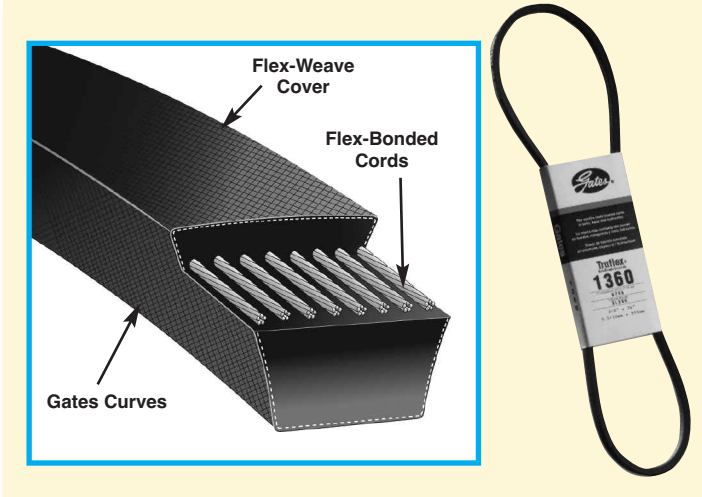

MARS NO.	Desc.	Case Qty.
B BELTS cont.		
74512	B158	10
74513	B162	20

3L BELTS		
74103	3L170	100
74104	3L180	100
74105	3L190	100
74106	3L200	100
74107	3L210	100
74108	3L220	100
74109	3L230	100
74110	3L240	100
74111	3L250	100
74112	3L260	100
74113	3L270	100
74114	3L280	10
74115	3L290	100
74116	3L300	10
74117	3L310	1
74118	3L320	100
74119	3L330	150
74120	3L340	100
74121	3L350	100
74122	3L360	100
74124	3L380	1
74125	3L390	1
74126	3L400	1
74128	3L420	1
74129	3L430	150
74130	3L440	50
74132	3L460	1

4L BELTS		
74153	4L150	5
74154	4L160	124
74155	4L170	25

MARS NO.	Desc.	Case Qty.
4L BELTS cont.		
74156	4L180	100
74157	4L190	100
74158	4L200	100
74159	4L210	150
74160	4L220	100
74162	4L230	100
74163	4L240	100
74164	4L250	100
74165	4L260	100
74166	4L270	100
74167	4L280	100
74168	4L290	50
74169	4L300	50
74170	4L310	70
74171	4L320	50
74172	4L330	50
74173	4L340	50
74174	4L350	50
74175	4L360	75
74176	4L370	50
74177	4L380	50
74178	4L390	100
74179	4L400	50
74180	4L410	50
74181	4L420	50
74182	4L430	110
74183	4L440	50
74184	4L450	110
74185	4L460	50
74186	4L470	110
74187	4L480	50
74188	4L490	50
74189	4L500	110
74190	4L510	75
74191	4L520	75
74192	4L530	74

MARS NO.	Desc.	Case Qty.
4L BELTS cont.		
74193	4L540	60
74194	4L550	60
74195	4L560	60
74196	4L570	60
74197	4L580	60
74198	4L590	60
74199	4L600	80
74200	4L610	40
74201	4L620	80
74202	4L630	50
74203	4L640	75
74204	4L650	50
74205	4L660	75
74206	4L670	70
74207	4L680	74
74208	4L690	75
74209	4L700	75
74210	4L710	75
74211	4L720	75
74212	4L730	75
74213	4L740	75
74214	4L750	75
74215	4L760	75
74216	4L770	75
74217	4L780	75
74218	4L790	75
74219	4L800	75
74220	4L810	75
74221	4L820	75
74222	4L830	5
74223	4L840	60
74224	4L850	2
74225	4L860	2
74226	4L870	75
74227	4L880	55
74228	4L890	55

MARS NO.	Desc.	Case Qty.
4L BELTS cont.		
74229	4L900	55
74230	4L910	55
74231	4L920	55
74232	4L930	55
74233	4L940	1
74234	4L950	1
74235	4L960	55
74236	4L970	55
74237	4L980	1
74238	4L990	55
74239	4L1000	55

5L BELTS		
74246	5L240	150
74247	5L250	150
74248	5L260	150
74249	5L270	50
74250	5L280	35
74251	5L290	130
74252	5L300	130
74253	5L310	50
74254	5L320	10
74255	5L330	10
74256	5L340	90
74257	5L350	10
74258	5L360	90
74259	5L370	10
74260	5L380	20
74261	5L390	90
74262	5L400	90
74263	5L410	75
74264	5L420	75
74265	5L430	75
74266	5L440	75
74267	5L450	75
74268	5L460	75

MARS NO.	Desc.	Case Qty.
5L BELTS cont.		
74269	5L470	75
74270	5L480	75
74271	5L490	75
74272	5L500	75
74273	5L510	55
74274	5L520	60
74275	5L530	60
74276	5L540	25
74277	5L550	50
74278	5L560	25
74279	5L570	15
74280	5L580	25
74281	5L590	15
74282	5L600	35
74283	5L610	35
74284	5L620	20
74285	5L630	60
74286	5L640	60
74287	5L650	60
74288	5L660	25
74289	5L670	15
74290	5L680	27
74291	5L690	60
74292	5L700	10
74293	5L710	50
74294	5L720	25
74295	5L730	25
74296	5L740	50
74297	5L750	50
74298	5L760	50
74299	5L770	50
74300	5L780	15
74301	5L790	50
74302	5L800	15
74303	5L810	55
74304	5L820	55

MARS NO.	Desc.	Case Qty.
5L BELTS cont.		
74305	5L830	55
74306	5L840	55
74307	5L850	55
74308	5L860	55
74309	5L870	55
74310	5L880	55
74311	5L890	55
74312	5L900	55
74313	5L910	55
74314	5L920	55
74315	5L930	55
74316	5L940	55
74317	5L950	55
74318	5L960	55
74319	5L970	55
74320	5L980	55
74321	5L990	55
74322	5L1000	55

AIR MARS

AM-32

The largest selection of motors, components and accessories for the HVAC/R Industry





Gates V-Belts

MARS SERIES **741**

Gates Tri-Power® Belts-AX, BX

Constructed with Gates proprietary Vextra® construction, this belt has a superior combination of flex and load carrying capacity, as well as less stretch resulting in less maintenance. Suitable for all industrial applications, particularly where small or sub-minimal sheave diameters are required.

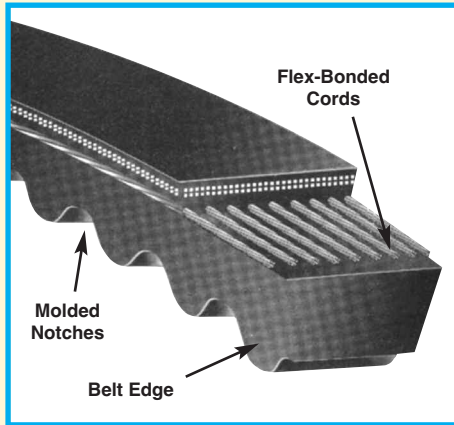

Super HC® Molded Notch Belts-5VX

Constructed with Gates proprietary construction, this belt has a superior combination of flex and load carrying capacity, as well as transmitting more horsepower than the classical cross sections in the same amount of drive space. Suitable for all industrial applications, particularly where space, weight and horsepower capacity are critical.

Features & Benefits:

- Notches molded in to the belt during manufacturing, make this belt well suited for drives with smaller diameter sheaves.
- Belt edge is machined for even sheave groove contact resulting in less slip and wear.
- Flex bonded cords are strongly bonded to the body of the belt resulting in equal load distribution and the absorption of bending stress without cord deterioration.
- Meets RMA oil and heat resistant standards
- Meets RMA static conductivity requirements.
- MARS Pack 1

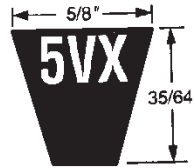
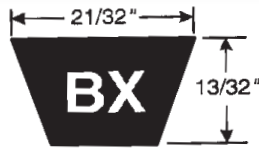
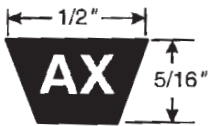

MARS NO.	Desc.	Case Qty.
5L BELTS		
74305	5L830	55
74306	5L840	45
74307	5L850	40
74308	5L860	40
74309	5L870	40
74310	5L880	40
74311	5L890	40
74312	5L900	40
74313	5L910	40
74314	5L920	40
74315	5L930	45
74316	5L940	45
74317	5L950	45
74318	5L960	45
74319	5L970	45
74320	5L980	45
74321	5L990	45
74322	5L1000	45

MARS NO.	Desc.	Case Qty.
AX BELTS		
74556	AX21	15
74557	AX22	5
74558	AX23	5
74553	AX24	5
74560	AX25	20
74566	AX26	25
74561	AX27	20

MARS NO.	Desc.	Case Qty.
AX BELTS cont.		
74555	AX28	20
74563	AX29	20
74564	AX30	10
74565	AX31	10
74554	AX32	50
74567	AX33	14
74568	AX34	15
74569	AX35	15
74570	AX36	15
74571	AX37	15
74572	AX38	10
74562	AX39	10
74573	AX40	10
74574	AX41	10
74575	AX42	15
74576	AX43	30
74604	AX44	10
74608	AX45	10
74577	AX46	55
74579	AX47	10
74578	AX48	5
74580	AX49	20
74598	AX50	10
74581	AX51	10
74599	AX52	5
74551	AX53	5
74582	AX54	15

MARS NO.	Desc.	Case Qty.
AX BELTS cont.		
74583	AX55	5
74600	AX56	10
74601	AX57	10
74584	AX58	5
74552	AX59	10
74585	AX60	4
74586	AX61	5
74587	AX62	5
74588	AX63	15
74589	AX64	10
74602	AX65	5
74603	AX66	5
74559	AX67	5
74590	AX68	5
74592	AX69	5
74749	AX70	5
74757	AX71	5
74514	AX72	5
74591	AX75	5
74593	AX80	5
74750	AX82	1
74594	AX85	1
74595	AX87	1
74596	AX90	5
74597	AX96	5

MARS NO.	Desc.	Case Qty.
BX BELTS		
74650	BX28	1
74662	BX30	1
74605	BX32	1
74666	BX34	10
74609	BX35	1
74610	BX36	5
74611	BX37	1
74612	BX38	4
74709	BX39	1
74613	BX39	40
74614	BX40	15
74615	BX41	1
74616	BX42	4
74617	BX43	5
74618	BX44	10
74710	BX45	10
74619	BX46	15
74620	BX48	10
74621	BX50	20
74607	BX51	50
74622	BX52	10
74623	BX53	5
74624	BX54	20
74625	BX55	1
74626	BX56	5
74629	BX58	10
74630	BX59	25

MARS NO.	Desc.	Case Qty.
BX BELTS cont.		
74631	BX60	25
74627	BX61	15
74632	BX62	20
74628	BX63	20
74633	BX64	10
74634	BX65	15
74635	BX66	10
74636	BX67	10
74637	BX68	5
74638	BX70	10
74639	BX71	10
74641	BX72	15
74640	BX73	5
74646	BX75	10
74648	BX76	5
74651	BX77	5
74655	BX78	5
74656	BX79	5
74642	BX80	5
74643	BX81	10
74658	BX82	5
74644	BX83	5
74652	BX84	5
74645	BX85	2
74659	BX90	5
74661	BX93	1
74660	BX95	1

continued on next page



The largest selection of motors, components and accessories for the HVAC/R Industry

AM-33

Gates V-Belts

MARS SERIES **741**



MARS NO.	Case Desc.	Qty.	MARS NO.	Case Desc.	Qty.	MARS NO.	Case Desc.	Qty.	MARS NO.	Case Desc.	Qty.	MARS NO.	Case Desc.	Qty.
BX BELTS cont.			3VX BELTS			5VX BELTS cont.			5VX BELTS cont.			AP Belts		
74606	BX96	1	74515	3VX315	1	74702	5VX670	1	74696	5VX1080	10	74746	AP46	1
74681	BX97	30	74516	3VX355	1	74703	5VX710	1	74697	5VX1120	10	74751	AP51	1
74683	BX99	5	74547	3VX670	1	74689	5VX750	12	74698	5VX1150	10	74755	AP55	1
74647	BX100	1	74523	3VX710	1	74708	5VX780	1	74699	5VX1180	1	74756	AP56	1
74649	BX103	1	74548	3VX750	5	74704	5VX800	1	74700	5VX1320	10	74758	AP58	1
74685	BX108	1	74550	3VX800	1	74690	5VX900	13	74701	5VX1400	20	74760	AP59	1
74670	BX112	30	74524	3VX850	1	74691	5VX930	5	74725	5V630	1	Miscellaneous Belts		
74686	BX116	1	74527	3VX900	1	74706	5VX950	1	74726	5V710	1	74991	C85	1
74687	BX128	1	5VX BELTS			74692	5VX960	10	74728	5V750	1	74990	C100	5
74705	BX133	10	74711	5VX500	1	74693	5VX1000	10	74729	5V800	1	74998	C136	1
74748	BX162	1	74688	5VX530	10	74694	5VX1030	10				74796	CX96	1
74759	BX173	1				74695	5VX1060	1						

Gates Accessories

MARS SERIES **741**



Gates Maintenance Tools

Belt Sizer

Measures FHP belts up to 107" to determine equivalent Truflex® belt numbers.

MARS NO.	Gates No.
74100	7401-0012

Sheave Gauge

Helps to identify worn sheaves and damaged belts.

MARS NO.	Gates No.
74099	7401-0014

Tension Tester

Pencil type tension tester is for use with all small v-belts and synchronous belts. Maximum deflection force 30 lbs.

MARS NO.	Gates No.
74101	7401-0076

Gates Merchandiser

Includes 12 three foot long strips with 8 hooks each.

MARS NO.	Gates No.
74000	7645-0003

