



Tjernlund Side Wall Venting Products

Reference Guide

Any non-condensing gas or oil fired heater that can be vented by natural draft can be Side Wall Vented with a Tjernlund Power Venter. Power Venters are available in a variety of capacities and also packaged for specific applications. All models feature built-in interlock controls and most have post-purge operation. Selection is based on type of fuel, burner type and the BTU/hr. input rating of the heater(s).

Safety proven Side Wall Venting Systems save time and money and are an excellent choice for electric-to-gas conversions, renovations, new construction and for replacing deteriorated chimneys. Side Wall Venting saves costly materials and labor on two, three or more story runs. Install heaters where it was previously impossible...in most cases up to 100 equivalent feet from an outside wall.



Venting for heating appliances doesn't have to go through the roof. Neither does the cost.

New Use our easy Side Wall Vent System Selection Tool @ www.tjernlund.com

Side Wall Power Vent Systems

Universal Control Model UC1

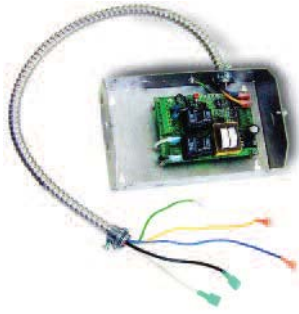

Solid state control interlocks any burner control circuit. Features include: adjustable pre and post purge, LED status/diagnostic indicators, prover switch delay to avoid burner start up and wind induced short cycling. Interlocks with any 24-120 VAC burner control circuit and also includes "dry" contact actuation option. Selectable voltage eliminates false activation by burner control check circuits.

Visit www.tjernlund.com to view brochure #8500004

Millivolt Gas Water Heater Venting Packages MODELS VP-2F & VP-3F



For Side Wall venting millivolt gas water heaters. Excellent for electric-to-gas conversions, renovations, new construction or for replacing old chimneys. Vents up to 75 equivalent feet and includes: Post-Purge Relay/Timer, Gas Pressure Switch, Thermocouple Junction Adapter, Linear Limit Spillage Switch and Vent Hood. Factory pre-wired electrical box and 24V Control Cables eliminate need for an electrician.

Visit www.tjernlund.com to view brochure #8500567

Power Venters Models HSJ, HS1, HS2, HS3, HS4, HS5

Includes
UC1



A full range of models from small residential to large commercial capacities. All models feature the UC1 interlock control, factory set Fan Proving Switch and adjustable damper to fine tune

vent system draft. Can be used on natural gas, LP and oil-fired furnaces, boilers and water heaters. We recommend using the SideShot vent systems for oil fired applications and do not recommend using the models HS3, 4, 5 for oil due to the potential volume of soot if the burner goes out of adjustment. Select the appropriately sized VH1-Series Vent Hood to complete your side wall vent system.

SideShot® Oil and Deluxe Gas Side Wall Vent Systems Models SS1, SS1C, SS2

Includes
UC1



The most technologically advanced side wall vent systems available. Now includes the UC1 Universal Control. Designed for oil fired heating equipment or a deluxe gas vent system. Patented terminus prevents staining by propelling flue gases away from the building exterior.

Features: zero clearance installation, pre-wired operation and safety controls and stainless steel construction in all critical components. The second generation SS2 features a self-cleaning blower wheel, ultra fine draft adjustment and slide out venter assembly.

Visit www.tjernlund.com to view brochure #8500000

Gas Power Venters and Vent Packages Models GPAK-JT*, GPAK-1T*, GPAK-1TR*

Primarily used for 80+ gas furnaces and boilers. Complete kit includes the Power Venter, VH1-4 4" Vent Hood and DC4 4" Draft Control packaged together.

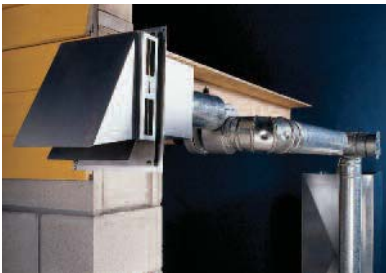

Visit www.tjernlund.com to view brochure #8500370

Accessories

Vent Hoods

Models VH1-3, VH1-4, VH1-6, VH1-8, VH1-10



Specially designed to terminate Tjernlund Side Wall Vent Systems. They are also an approved method of terminating many horizontally vented appliances. Vent hoods feature heavy duty, corrosive-resistant aluminum construction. Models VH1-3, 4 and 6 also have built in clearances from combustibles. Building exteriors are kept clean while the structure's exterior aesthetics remain undisturbed. All mounting hardware is included.

Accessories

Multiple Appliance Controls

Models MAC1E, MAC4E



Used with any UC1 controlled venter to interlock additional 24/115 VAC heaters. Powered by and communicates with the UC1 through a factory wired whip. For one additional 24/115 VAC heater add the MAC1E. To interlock up

to four more additional 24/115 VAC heaters, add the MAC4E. MAC4E's can be daisy chained together for greater than 5 heaters. **Important:** Total combined BTU/hr. input of all heaters and total equivalent pipe lengths must be within venter's capacity.

Barometric Draft Controls

Models DC4, DC5, DC6, DC7, DC8, DC9, DC10
DC4G, DC6G, DC7G, DC8G, DC9G, DC10G



Quality engineered and manufactured to maintain a consistent draft on a wide range of oil and gas fired heating equipment. May be used with chimney vented or power vented heating equipment. For fan assisted gas, oil or solid fuel applications with vent diameters from 4"-10", choose the DC4 thru DC10.

For LP and natural gas applications with vent diameters from 4"-10", choose the DC4G thru DC10G.

Visit www.tjernlund.com to view brochure #8500490

Millivolt Interlock Kit

Model WHKE



For use with UC1 Universal Control, MAC1E or MAC4E auxiliary controls. The WHKE gas pressure switch actuates the venter through the A - B Dry contacts. The Linear Limit switch disables the heater in the event of a venting malfunction. Includes JA1 thermocouple junction adapter. To interlock

millivolt water heater(s) only with a UC1 controlled venter add a WHKE for each millivolt heater. To interlock a millivolt water heater and one 24/115 VAC furnace or boiler with a UC1 controlled venter, add a WHKE and a MAC1E.

Side Wall Venting Termination Requirements

NOTE: Termination of a Side Wall Vent System with a device other than the Tjernlund VH1 Series Hood could affect system performance and result in a possible safety hazard. Consult Vent Hood Instructions for complete installation details.

Vent Hood Termination Code Requirements for U.S. Installations

If possible, locate the Vent Hood on a wall that does not face the direction of prevailing winds. This will diminish the possibility of appliance interruption during periods of extreme winds and prevent oil odors caused by backdrafts.

If possible, locate the Vent Hood no closer than 3 feet from an inside corner of an L-shaped structure.

Terminate the vent system so that proper minimum clearances are maintained as cited in the latest edition of the National Fuel Gas Code (NFPA #54) and the latest edition of NFPA #211, or as follows:

- Not less than 7 feet above grade when located adjacent to public walkways...
- At least 3 feet above any forced air inlet located within 10 feet...
- At least 4 feet below, 4 feet horizontally from or 1 foot above any door, window or gravity air inlet into any building...
- At least 12 inches above grade...
- So that the flue gases are not directed so as to jeopardize people, overheat combustible structures or enter buildings, and...
- Not less than 2 feet from an adjacent building.

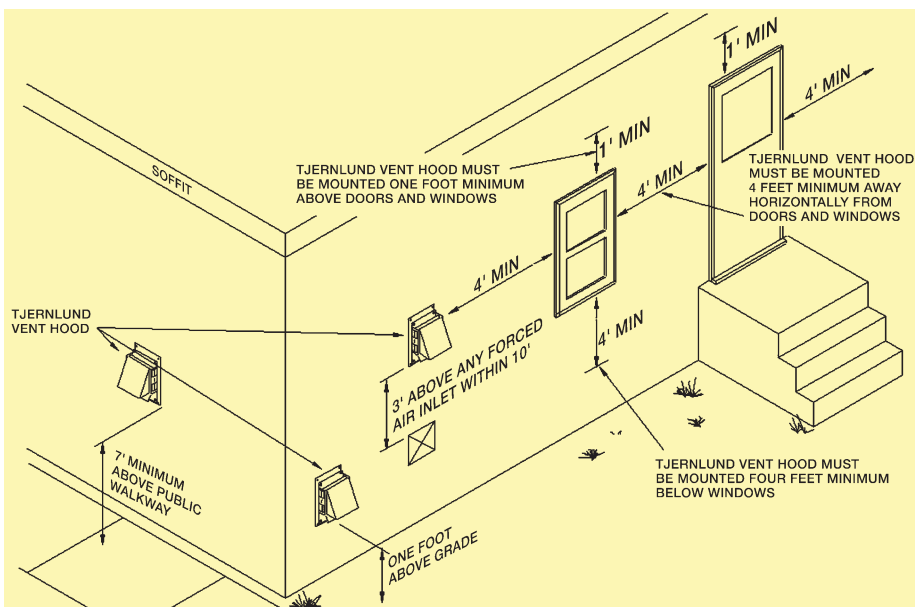

Selecting the Proper Power Venter

NOTE: The vent pipe diameter in a Power Vent system is usually smaller than that of a chimney vented appliance. Select the Power Venter based on the BTU/hr input of the appliance(s) rather than the diameter of the appliance vent outlet. Use a tapered reducing collar or transition fitting to reduce vent pipe to diameter listed in selection table. To determine equivalent feet, add the total length of straight vent pipe plus 10 feet for each 90 degree elbow and 5 feet for each 45 degree elbow.

HS Series (Residential/Light Commercial)

Model Numbers	Vent Pipe Dia.	BTU/hr Input	Maximum Pipe Length (Ft.) At Stack Temp.			CFM at 70° F				
			Gas Fired		Oil Fired	0" SP	.50" SP	.75" SP	1.0" SP	1.4" SP
			300° F	400° F						
HSJ	4"	50,000	100'	100'	100'	110	85	67	10	-
		75,000	100'	100'	100'					
		100,000	100'	100'	100'					
		125,000	35'	23'	-					
HS1	4"	150,000	100'	60'	35'	158	115	95	12	-
		200,000	87'	57'	27'					
		250,000	40'	12'	-					
	6"	150,000	100'	100'	100'					
		200,000	100'	100'	100'					
		300,000	100'	92'	-					
HS2	6"	350,000	100'	100'	100'	286	235	215	196	158
		400,000	100'	100'	100'					
		450,000	100'	100'	67'					
		500,000	100'	72'	-					
		550,000	94'	-	-					
	8"	600,000	15'	-	-					
		350,000	100'	100'	100'					
		400,000	100'	100'	100'					
		450,000	100'	100'	100'					
		600,000	100'	100'	100'					

HS3, 4, 5 Series (Commercial)

Model Numbers	Vent Pipe Dia.	BTU/hr Input	Maximum Pipe Length (Ft.) at Stack Temp.		CFM at 70° F										
			100% Dilution 300°F	25% Dilution 400°F	0" SP	.50" SP	.75" SP	1.0" SP	1.4" SP						
			GAS FIRED Atmospheric with Draft Hood or Draft Diverter	GAS FIRED Power Burner with Barometric											
HS3	8"	450,000	100'	100'	500	425	380	325	110						
		500,000	100'	100'											
		600,000	100'	100'											
	10"	700,000	7'	100'											
		450,000	100'	100'											
		700,000	21'	100'											
HS4	8"	700,000	100'	100'	925	800	730	620	425						
		800,000	100'	100'											
		900,000	100'	100'											
		1,000,000	70'	100'											
		1,100,000	32'	100'											
		1,200,000	5'	100'											
		10"	700,000	100'						100'					
	800,000		100'	100'											
	900,000		100'	100'											
	1,000,000		100'	100'											
	1,100,000		97'	100'											
	1,200,000		14'	100'											
	HS5		10"	1,200,000						100'	100'	1425	1250	1200	1130
		1,400,000		100'						100'					
1,600,000		100'		100'											
1,825,000		29'		100'											
1,200,000		100'		100'											
12"		1,400,000	100'	100'											
		1,600,000	100'	100'											
		1,825,000	72'	100'											
		14"	1,200,000	100'	100'										
			1,400,000	100'	100'										
1,825,000	100'		100'												

NOTE: For capacities over 1,825,000 BTU/hr., consult factory.

Selecting the Proper SideShot® Vent System

Verify that the total BTU/hr. input of the heating appliance(s) falls within the proper category listed. All BTU/hr. capacity ranges are based on a maximum of 50 equivalent feet. To determine equivalent feet, add the total length of straight vent pipe plus 10 feet for each 90 degree elbow and 5 feet for each 45 degree elbow. Vent runs of over 15 linear feet should use an approved insulated vent connector to prevent problems related to condensation.

NOTE: BTU inputs less than 105,000 may require use of insulated vent pipe for linear runs exceeding 10 feet.

MODEL	Natural & LP Gas	Flame Retention Oil Burner	Conventional Oil Burner	Max. Equivalent Feet
SS1	50,000 - 160,000 BTU/hr.	50,000 - 220,000 BTU/hr. 1.55 gal/hr. max	50,000 - 180,000 BTU/hr. 1.25 gal/hr. max	50
MODEL	Flame Retention Oil Burner	Conventional Oil Burner	Max. Equivalent Feet	
SS1C	50,000 - 315,000 BTU/hr. 2.25 gal/hr. max.	50,000 - 223,000 BTU/hr. 1.59 gal/hr. max.	50 15.2 meters	

Model	Flame Retention Oil Burner	Fan Assisted Natural & LP Gas	Atmospheric Natural & LP Gas	Max. Equivalent Feet
SS2	70,000 - 168,000* 1.2 gal/hr. max.	40,000 - 150,000 BTU/hr	40,000 - 125,000 BTU/hr	50

*Maximum capacity based on 13% CO₂ and Max. 500°F inlet temperature. Consult factory for details.

Model Selection Tables

GPAK* Series Selection Table

Models	Vent Pipe Diameter	BTU/hr Input	Maximum Total Vent Pipe Length		
			Atmospheric A	Fan Assisted B	*40,000 ATM +Column B C
GPAK-JT*	4"	45,000	100'	60'	60'
		75,000	100'	60'	60'
		100,000	100'	60'	N/A
		120,000	45'	60'	N/A
GPAK-1T*	4"	100,000	100'	60'	60'
		120,000	100'	60'	60'
		150,000	100'	60'	60'
		200,000	87'	N/A	N/A
		250,000	40'	N/A	N/A

NOTES:

- If the appliance flue outlet is greater than 4", install a tapered reducer after the draft hood, draft diverter or barometric draft control, reducing vent pipe diameter to 4". All vent pipe from the appliance to the Power Venter may be 4".
- Table is based on straight vent pipe. 90 degree elbows are equivalent to 6 feet of straight vent pipe.
- Determine maximum pipe length from type of equipment being vented and GPAK Model. **Column A pipe runs over 30 linear feet should use Type "B" vent. Column B & C pipe runs over 15 linear feet should use Type "B" vent.**
- Column C allows for up to a 40,000 BTU/hr. input atmospheric water heater common vented with a fan assisted appliance from column B.
- All reducers and vent pipe are to be supplied by the installer and are available from your local heating wholesaler.
- GPAK* Series include a DC-4 Draft Control and VH1-4 Vent Hood and are authorized for use on furnaces eligible for the HTPV Corrective Action Program. Installations for the HTPV Program must use Type "B" vent.
- Also available, GPAK-1TR* for use with Rheem, Ruud, Weatherking and Heat Controller brands.

VP Series Millivolt Water Heater Vent Packages

Models	Burner Capacity	Maximum Venting Length	Vent Pipe Diameter
VP-2F	Up to 60,000 BTU/hr	75 equivalent feet	3"
VP-3F	60,000 to 120,000 BTU/hr	75 equivalent feet	4"

Model Dimensions

VH1 Series Vent Hood Dimensions

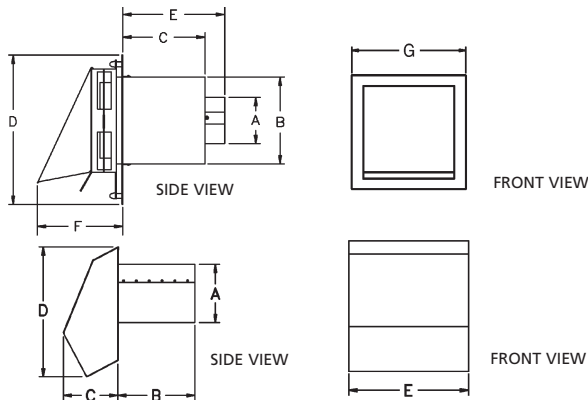

Model	Dimensions							Rough-In Dimensions
	A Dia.	B	C	D	E	F	G	
VH1-3	3"	6 1/4" Sq.	8 1/2"	10"	10"	5 1/4"	7 3/4"	6 3/4" Sq.
VH1-4	4"	7 1/2" Sq.	7 1/8"	13"	8 5/8"	7 3/8"	11"	8" Sq.
VH1-6	6"	8 1/2" Dia.	7 7/8"	12"	9 1/2"	10 1/2"	10"	9" Dia.

Model	Dimensions					Rough-In Dimensions
	A Dia.	B	C	D	E	
VH1-8	8"	16"	7 3/4"	18 3/8"	20"	8 1/2" Dia.
VH1-10	10"	16"	7 3/4"	18 3/8"	20"	10 1/2" Dia.

HS/GPAK Series Dimensions

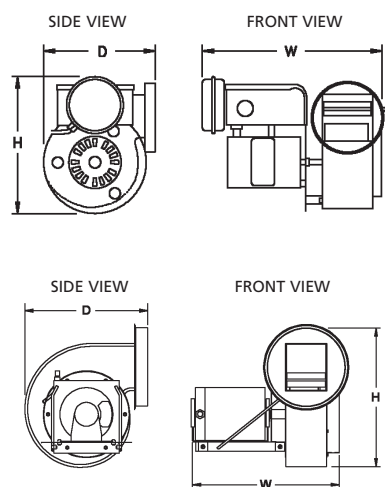

Unit Dimensions (In.)				
Model	(H) Height	(W) Width	(D) Depth	Inlet/Outlet
HSJ GPAK-JT*	7 7/8"	10 1/4"	7"	4"
HS1 GPAK-1T*	7 7/8"	11"	7"	4"
HS2	9 1/4"	11 1/2"	8 1/2"	6"

Unit Dimensions (In.)				
Model	(H) Height	(W) Width	(D) Depth	Inlet/Outlet
HS3	12 1/2"	13 1/4"	11"	8"
HS4	14 3/4"	15 1/4"	13"	8"
HS5	18"	16 1/2"	16 1/2"	10"

VP Series Dimensions

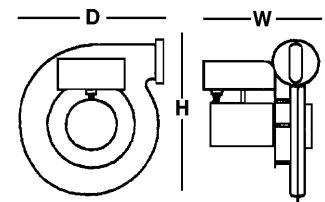

Unit Dimensions (In.)				
Model	(H) Height	(W) Width	(D) Depth	Inlet/Outlet
VP-2F	10 1/2"	7 1/2"	10"	3"
VP-3F	7 7/8"	10 1/4"	7"	4"

VP-2F includes VH1-3 Vent Hood.
VP-3F includes VH1-4 Vent Hood.

UC1 Universal Control is 8" x 5" x 2 3/4" and includes a 2' wire whip.

Model Dimensions

SideShot® Models SS1 & SS1C Dimensions

A	B	C	D	E	F	G	H	I
27-3/8"	16-1/2"	12-1/4"	8"	13-3/4"	15-1/8"	7-3/4"	14-3/4"	23-1/4"

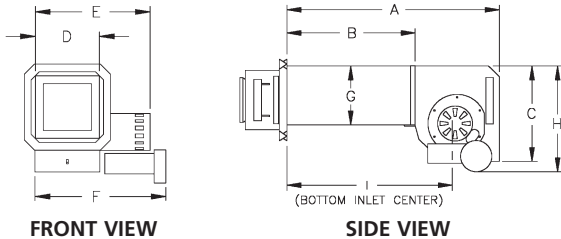

NOTE: The SS1 features a bottom or rear vent connection. The inlet collar accepts any brand or type of 6" diameter vent pipe. The SS1 requires an 8"H x 8 3/8"W opening through the wall.

SideShot® Model SS2 Dimensions

A	B	C	D	E	F	G	H	I	J
32-1/2"	28-1/2"	5-1/2"	22-3/8"	7-3/4"	8"	12-1/2"	13-1/4"	10-1/2"	8-1/2"

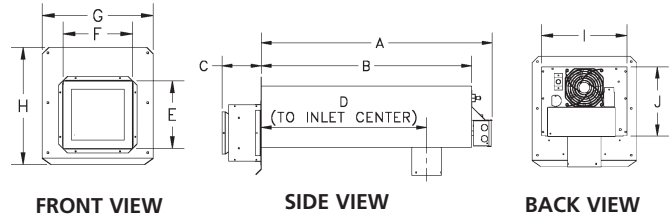

NOTE: SS2 has a 4" vent connector. Install full size vent pipe and reduce at SS2 connector. The SS2 requires an 8 1/2"H x 10 1/2"W opening through the wall.

Model Electrical Specifications

Model	Voltage	Power Requirements in Amps	Safety Circuit Max. Load in Amps
HSJ	115/1/60	1.76	15*
GPAK-JT*	115/1/60	1.26	3
HS1	115/1/60	1.76	15*
GPAK-1T*	115/1/60	1.26	3
GPAK-1TR*	115/1/60	1.26	3
HS2	115/1/60	2.0	15*
HS3	115/1/60	3.2	15*
HS4	115/1/60	6.3	15*
HS5	115/1/60	13.1	15*
	208/1/60	6.2	15****
	230/1/60	6.3	15****

Model	Voltage	Power Requirements in Amps	Safety Circuit Max. Load in Amps
SS1	115/1/60	2.8	15*
SS1C	115/1/60	2.8	15*
SS2	115/1/60	2.3	15*
VP-2F	115/1/60	1.35	N/A**
VP-3F	115/1/60	1.76	N/A**
UC1	115/1/60	0.50	15*
MAC1E	115/1/60	0.05***	15*
MAC4E	115/1/60	0.15***	15*
WHKE	5VDC	N/A	N/A

All products are Listed to various National and International Codes.

Consult the factory or visit our web site at: www.tjernlund.com under the instructions download button to view instruction manuals. Listings are on the cover of each manual.

* UC1, MAC1E, MAC4E appliance interlock relay contacts rated for 15 amps or 1 HP.
 ** Self-contained safety circuit does not interlock directly with gas valve.
 *** Power for MAC1E and MAC4E comes from UC1. Add amps listed to that of UC1.
 **** UC1 must be wired with 115 VAC. Add UC1 amp draw of .5 to total amps listed.
 If wiring the HS5 motor for 208-230 VAC in conjunction with the UC1 Universal Control, a 115 VAC coil, DPST motor contactor rated for 1 HP is required.

Tjernlund Products also offers:

Auto-Draft variable & fixed speed inducers. For roof top or side wall venting. Reduce vent diameters by up to 50% and overcome convoluted vent layouts. Fan speed is automatically regulated based on a user set manifold/vent pressure, resulting in perfect draft and true energy savings. Virtually unlimited capacities.

Combustion Air In-Forcers provide dedicated combustion air for safer, more efficient equipment operation. Eliminates burner control lockouts & oil odors associated with back-drafting. Ideal for "confined space" and electric to oil or gas conversions. Residential and commercial fixed & variable speed models available.



Auto-Draft® Vent Systems

Combustion Air In-Forcer™

Available From:



TJERNLUND PRODUCTS, INC.

1601 Ninth Street White Bear Lake, MN 55110-6794
 Phone: 651.426.2993 800.255.4208 Fax: 651.426.9547
 Visit our web site: www.tjernlund.com

Copyright © 2008 Tjernlund Products, Inc. P/N 8500594 Rev D 07/08