



Air Cocks
Gas Cocks
Hose Bibbs
Boiler Drains

PLUMBING SPECIALTIES



PLUMBING SPECIALTIES

Air Cocks
Gas Cocks
Hose Bibbs
Boiler Drains



PLUMBING SPECIALTIES

Compression Gauge Cocks

26-100/26-300 SERIES



26-300

COMPRESSION GAUGE COCKS

For draining expansion tanks, other liquid storage vessels. For condensate only. Standard finish is Satin Brass.

FEATURES

- 26-100: rated up to 125 psig
- 26-300: soft metal seat/stuffing box rated up to 250 psig at 400°F
- 26-310: stainless steel ball seat/stuffing box rated up to 250 psig at 400°F
- 26-700: TFE seat, rated up to 250 psig at 400°F

Series Number	Pipe Size (in.)	Wt./100 (lbs.)	Wheel Type
26-101-01	3/8	25.0	ALUMINUM
26-102-01	3/8	30.0	COMPOSITION
26-104-01	1/2	28.3	ALUMINUM
26-105-01	1/2	30.0	COMPOSITION
26-301-01	3/8	39.0	ALUMINUM
26-302-01	3/8	40.0	COMPOSITION
26-304-01	1/2	40.0	ALUMINUM
26-305-01	1/2	44.0	COMPOSITION
26-307-01	3/4	49.0	ALUMINUM
26-308-01	3/4	51.7	COMPOSITION
26-311-01	3/8	39.0	ALUMINUM
26-312-01	3/8	42.0	COMPOSITION
26-314-01	1/2	40.0	ALUMINUM
26-315-01	1/2	44.0	COMPOSITION
26-317-01	3/4	50.0	ALUMINUM
26-318-01	3/4	50.0	COMPOSITION
26-704-01	1/2	78.0	ALUMINUM
26-705-01	1/2	82.0	COMPOSITION
26-707-01	3/4	88.0	ALUMINUM
26-708-01	3/4	105.0	COMPOSITION

*26-100 series is not available with packing nut

Specify the following suffix for finish: Polished Brass -28 (example: 26-304-28)

Compression Cock

26-500 SERIES



LEVER OPERATED COMPRESSION COCK

For draining expansion tanks or other liquid storage vessels where the drain port is beyond reach. Spring loaded lever provides positive closure to 250 psig at 300°F.

FEATURES

- Bronze body B584 UNS C84400
- Stainless steel closure spring
- PTFE soft seat
- Graphite stem packing
- Zinc plated "S" hook on lever
- Optional 6 foot chain
- Rated up to 250 psig

Series Number	Pipe Size (in.)	Wt./100 (lbs.)	
26-504-01	1/2	110	
26-504-02	1/2	112	6' chain
26-507-01	3/4	115	
26-507-02	3/4	117	6' chain

COMMERCIAL PRODUCTS CATALOG

Steam Gauge Siphon

27-400 SERIES



27-401



27-402

STEAM GAUGE SIPHON

For pressure gauge protection .

FEATURES

- Heavy gauge seamless brass tubing
- Brass (-01)
- Chrome plate (-03)
- 27-401 is 180° loop, 27-402 is 90° loop
- Service rating: 250 psig saturated steam, 400 psig at 100°F

Series Number	Pipe Size (in.)	Wt./100 (lbs.)
27-401-01	1/4	44.0
27-402-01	1/4	40.0

PLUMBING SPECIALTIES

Air Cocks

41 SERIES









AIR COCKS (FOR AIR USE ONLY)







An economical way to shut-off air lines. Standard spring bottom (-01) with 5/32" port are tested at 80 psig. Optional nut bottom (-04) with 1/8" port are suitable for pressures to 200 psig. Various handle configurations available.

FEATURES

- Standard spring bottom (5/32" port) air cocks tested at 80 psi
- Optional nut bottom (1/8" port) suitable to 200 psig
- Standard Satin Brass finish
- Maximum temperature is 500° F

Type	Satin Brass
Standard Spring Bottom	-01
Nut Bottom	-04



	Series Number	Pipe Size (in.)	Wt./100 (lbs.)
	TEE HANDLE ROUND SHOULDER		
	41-060	1/8	12.8
	41-070	1/4	13.0
	TEE HANDLE HEXAGON SHOULDER		
	41-080	3/8	17.0
	41-090	1/2	20.0
	LEVER HANDLE ROUND SHOULDER		
	41-120	1/8	13.1
	41-130	1/4	14.2
	LEVER HANDLE HEXAGON SHOULDER		
	41-140	3/8	17.0
	41-150	1/2	22.9
	TEE HANDLE DOUBLE MALE THREAD		
	41-180	1/8	14.0
	41-190	1/4	17.9
	41-203	3/8	20.0
	41-210	1/2	33.1
	LEVER HANDLE DOUBLE MALE THREAD		
	41-220	1/8	14.0
	41-230	1/4	18.5
	41-240	3/8	19.1
	41-251	1/2	31.3
	TEE HANDLE BIBB NOSE		
	41-260	1/8	14.5
	41-270	1/4	16.3
	41-280	3/8	33.3
	41-330	1/2	36.0
	LEVER HANDLE BIBB NOSE		
	41-290	1/8	16.5
	41-300	1/4	15.0
	41-310	3/8	32.1
	41-320	1/2	36.0



	Series Number	Pipe Size (in.)	Wt./100 (lbs.)
	TEE HANDLE DOUBLE FEMALE		
	41-370	1/8	13.0
	41-380	1/4	14.0
	41-390	3/8	26.0
	41-391	1/2	27.0
	TEE HANDLE MALE & FEMALE		
	41-400	1/8	13.0
	41-410	1/4	14.0
	41-420	3/8	21.0
	41-421	1/2	26.0
	LEVER HANDLE DOUBLE FEMALE		
	41-430	1/8	14.8
	41-440	1/4	13.0
	41-450	3/8	23.0
	41-451	1/2	27.0
	LEVER HANDLE MALE & FEMALE		
	41-460	1/8	15.2
	41-470	1/4	15.0
	41-480	3/8	23.0
	41-481	1/2	27.0
	TEE HANDLE MALE & FEMALE HEX SHOULDER		
	41-490	1/8	17.0
	41-500	1/4	15.0
	41-510	3/8	23.0
	41-511	1/2	25.0
	LEVER HANDLE MALE & FEMALE HEX SHOULDER		
	41-520	1/8	14.0
	41-530	1/4	15.0
	41-540	3/8	22.1
	41-541	1/2	27.0

COMMERCIAL PRODUCTS CATALOG

Air Cocks

41 SERIES (CONT.)

	Series Number	Size (in.)	Wt./100 (lbs.)
	TEE HANDLE DOUBLE FEMALE HEX SHOULDER		
	41-550	1/8	17.0
	41-560	1/4	17.0
	41-570	3/8	25.0
	41-571	1/2	28.3
	LEVER HANDLE DOUBLE FEMALE HEX SHOULDER		
	41-580	1/8	15.0
	41-590	1/4	18.2
	41-600	3/8	24.0
	41-601	1/2	28.8

	Series Number	Size (in.)	Wt./100 (lbs.)
	TEE HANDLE STRAIGHT NOSE HEX SHOULDER		
	41-630	1/8	15.7
	41-640	1/4	15.0
	LEVER HANDLE STRAIGHT NOSE HEX SHOULDER		
	41-650	1/8	14.0
	41-660	1/4	15.0

Air Cocks

41 SERIES HEAVY PATTERN



HEAVY AND EXTRA HEAVY PATTERN AIR AND STEAM COCKS

Heavy and extra heavy patterns for higher pressure applications.

FEATURES

- Satin brass finish
- Spring Bottom (-01) is tested at 100psi
- Rated for air pressure up to 250 psig with nut version
- Extra heavy pattern rated for 150 SWP - nut bottom only

Type	Suffix Code
Spring Bottom (Standard)	-01
Nut Bottom	-04

Series Number	Size (in.)	Wt./100 (lbs.)
HEAVY PATTERN TEE HANDLE DOUBLE FEMALE		
41-102-01	1/4	28.00
LEVER HANDLE DOUBLE FEMALE		
41-103-01	1/4	27.00
EXTRA HEAVY PATTERN TEE HANDLE DOUBLE FEMALE		
41-200-01	1/8	32.00
41-202-01	1/4	32.00
TEE HANDLE DOUBLE FEMALE HEXAGON SHOULDER		
41-222-01	1/4	38.00
TEE HANDLE MALE AND FEMALE		
41-250-01	1/4	20.00

PLUMBING SPECIALTIES

Drain Cocks

42-100 SERIES



DRAIN COCKS

Cast brass construction; rated for 25 psig.

FEATURES

- Sizes: 1/8", 1/4", 3/8" and 1/2"
- Cast brass finish
- Standard spring bottom (suffix code -01)

Series Number	Size (in.)	Orifice (in.)	Wt./100 (lbs.)
42-101-01	1/8	3/16	20.4
42-102-01	1/4	1/4	15.0
42-103-01	3/8	3/8	35.0
42-104-01	1/2	3/8	38.0

Steam Gauge Cocks

43-100 SERIES



STEAM GAUGE COCKS

Female fitting with male union for easy installation.

FEATURES

- Satin brass finish
- Rated 100 SWP for standard bottom, 150 SWP for nut version

Type	Suffix Code
Standard Spring Bottom	-01
Nut Bottom	-04

Series Number	Description	Size (in.)	Wt./100 (lbs.)
43-101-01	100 SWP	1/4 FNPT	45
43-101-04	150 SWP	1/4 FNPT	45

Air Cocks

44-100 SERIES



HOSE END COCKS

Interior diameter hose sizes: 3/8" to 7/16"

FEATURES

- 3/16" port; rated 25 psig
- Satin brass finish

Series Number	Size (in.)	Wt./100 (lbs.)
44-101-01	1/8	19
44-102-01	1/4	22
44-103-01	3/8	23
44-104-01	1/2	25

COMMERCIAL PRODUCTS CATALOG

Gas Cocks

GCB (50) SERIES



MANUAL MAIN CONTROL VALVES

CSA design certified for 1/2 psig and temperatures from 32° to 125°F. Complies to ANSI Z 21.15, CSA 9.1

FEATURES

- Factory tested 100% at 10 psig
- Bronze construction, stainless steel springs
- Capacities to 7.8 million BTU/hour
- Equal female inlet/outlet
- Bosses on both sides are drilled and tapped. Only one side is plugged

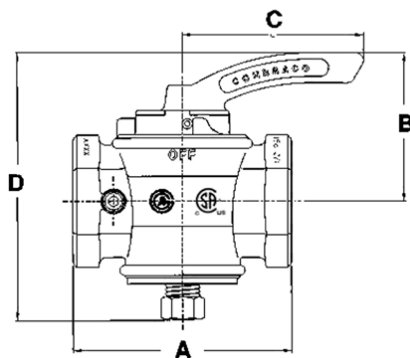

Series Number	Size (in.)	BTU/hr.	Wt./100 (lbs.)	Dimensions			
				A	B	C	D
50-203*	1/2	800,000	88	2.50	1.44	1.72	2.75
50-303	3/4	1,310,000	156	2.94	1.69	2.06	3.50
50-403	1	2,100,000	197	3.94	2.19	2.87	3.87
50-503	1-1/4	3,250,000	300	3.66	2.75	3.16	4.69
50-603	1-1/2	3,700,000	478	4.37	3.31	3.50	5.75
50-703	2	7,300,000	845	5.44	3.72	4.50	6.75
50-803	2-1/2	7,800,000	1000	5.87	3.72	4.50	6.75

* 1/2" size is not CSA certified

HANDLE SUFFIX POSITION

Size Pilot (in.)	W	X	Y	Z
1/8 NPT	01	02	03	04
1/4 NPT	05	06	07	08

All main burner valves furnished with 1/8" NPT pilot tapping. Valves 1" and larger can be furnished with 1/4" NPT pilot tapping.

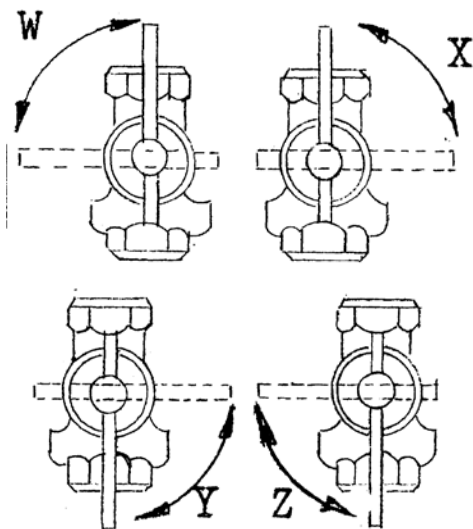

PLUMBING SPECIALTIES

Gas Cocks

GC (51) SERIES



GAS SERVICE COCKS

Tee or lever handle cocks; CSA design certified. In sizes 1/4" to 3/4".

FEATURES

- Capacities: 117,000 to 749,000 BTU/hour
- Certified to ANSI Z21.15 and CSA 9.1 (1/2 psig at temperatures from 32° F to 125°F)
- Accepted for use in City of New York Department of Buildings MEA 45-90-M

Series Number	Pipe Size (in.)	Wt./100 (lbs.)	Capacity (BTU/hr.)
T-HANDLE W/STOP			
51-103-01	1/4	35	117,000
51-104-01	3/8	47	274,600
51-105-01	1/2	54	274,000
51-106-01	3/4	83	749,000
LEVER HANDLE W/STOP			
51-107-01	3/8	50	274,600
51-108-01	1/2	56	274,600
51-109-01	3/4	87	749,000

Gas Cocks

GC2 (52) SERIES



GAS SERVICE COCKS

Available with tee head, flat head, square head or lever head in sizes from 1/4" to 1". Wrench operated and tested at 125 psig.

FEATURES

- High pressure rating
- Capacities: 117,000 to 749,000 BTU/hour
- Accepted for use in City of New York Department of Buildings MEA 45-90-M
- Max. temperature: 500°F

Series Number	Size (in.)	Wt./100 (lbs.)	Series Number	Size (in.)	Wt./100 (lbs.)
T-HEAD			SQUARE HEAD		
52-101-01	1/4	32.0	52-301-01	1/4	31.0
52-102-01	3/8	29.0	52-302-01	3/8	28.0
52-103-01	1/2	45.0	52-303-01	1/2	43.0
52-104-01	3/4	65.8	52-304-01	3/4	62.7
52-105-01	1	92.9	52-305-01	1	90.0
FLAT HEAD			LEVER HEAD		
52-201-01	1/4	30.0	52-401-01	1/4	34.3
52-202-01	3/8	28.0	52-402-01	3/8	31.0
52-203-01	1/2	43.0	52-403-01	1/2	46.0
52-204-01	3/4	57.0	52-404-01	3/4	66.7
52-205-01	1	90.6	52-405-01	1	97.0

COMMERCIAL PRODUCTS CATALOG

Gas Cocks

GC3 (53) SERIES



GAS COCKS

Available in male and female sizes: 1/8", 1/4" and 3/8".

FEATURES

- Capacities: 117,000 to 749,000 BTU/hour
- 200 CWP
- Certified to ANSI Z21.15 and CSA 9.1 (1/2 psig at temperatures from 32° F to 125°F)
- Accepted for use in City of New York Department of Buildings MEA 45-90-M

Series Number	Male Size (in.)	Female Size (in.)	Wt./100 (lbs.)
53-299-01*	1/8	1/8	14.0
53-300-01*	1/4	1/4	18.5
53-301-01	3/8	3/8	45.0

* Design certified by CSA to meet ANSI Z21.15.CSA 9.1 pressure requirements of 1/2 psig

Gas Cocks

GCA (54) SERIES



54-100



54-200



GAS HOSE COCKS & APPLIANCE CONNECTOR VALVES

FEATURES

- CSA design certified bronze gas valves with 56,500 BTU/hour capacity.
- Certified to ANSI Z21.15 and CSA 9.1 (1/2 psi at 32° F to 125°F)

Series Number	Pipe Size (in.)	Outlet (in.)	Wt./100 (lbs.)
54-101-01	3/8	1/8 MNPT	41.0
54-102-01	1/2	1/8 MNPT	34.8
54-103-01	3/4	1/8 MNPT	40.0

Series Number	Pipe Size (in.)	Outlet (in.)	Wt./100 (lbs.)
54-201-01	3/8	3/8 SAE	36.0
54-202-01	1/2	3/8 SAE	33.4
54-203-01	1/2	1/2 SAE	35.0
54-204-01	3/4	1/2 SAE	45.1
54-206-01	3/4	5/8 SAE	50.0
54-207-01	1/2	5/8 SAE	57.0
54-208-01	3/4	3/8 SAE	44.0
54-209-01	3/4	1/2 MNPT	44.0

PLUMBING SPECIALTIES

Gas Cocks

GCR (55) SERIES

GAS COCK WITH THROTTLE ADJUSTMENT DESIGN CERTIFIED BY CSA



FEATURES

- Certified to ANSI Z21.15 and CSA 9.1 (1/2 psig at 32° F to 125°F)
- Thread size: 1/4" male x 1/4" female

Series Number	Size (in.)	Wt./100 (lbs.)
55-302-01	1/4 M x 1/4 F	33

Gas Cocks

GCP (56) SERIES





PILOT COCKS

Wide variety of CSA design certified pilot cocks.



FEATURES

- Certified to ANSI Z21.15 and CSA 9.1 (1/2 psig at 32° F to 125°F)

	Model Number	Size (in.)	Wt./100 (lbs.)
	56-111-01	1/8 NPT x 1/4 Tube Plain	15.0
	56-112-01	1/8 NPT x 1/4 Tube Throttle Adjust.	14.0
	56-221-01	1/8 NPT x 1/8 FNPT Plain	16.1
	56-222-01	1/8 NPT x 1/8 FNPT Throttle Adjust.	16.1
	56-601-01	1/8 NPT x 1/4 Tube Right Hand	17.0
	56-602-01	1/8 NPT x 1/4 Tube RH Throttle Adjust	17.0
	56-603-01	1/8 NPT x 1/4 Tube Left Hand.	17.0
	56-604-01	1/8 NPT x 1/4 Tube LH Throttle Adjust.	17.0

COMMERCIAL PRODUCTS CATALOG

Compression Bibb Faucet

HB (35-200) SERIES



COMPRESSION BIBB FAUCET

Features heavy pattern with large flow path.

FEATURES

- Solid bronze construction
- Both models have 3/4" hose connection
- Aluminum handwheel
- Made in USA

Series Number	Pipe Size (in.)	Wt./100 (lbs.)
35-201-01	1/2	58.3
35-202-01	3/4	57.0

Water Heater Drain Valves

BD90 (31-200/31-500) SERIES



90° DRAIN VALVES

For deluxe water heaters and low pressure boilers.

FEATURES

- Max. rated pressure: 200 psig
- Max. rated temperature: 250°F
- Red aluminum wheel handle
- Optional plain finish handle (-04P)
- 31-200 Series heavy pattern, 3/4" MNPT inlet
- 31-500 Series standard pattern, 1/2" MNPT inlet with I.D. of NPT thread machined for 1/2" copper pipe
- Made in USA

Series Number	LF Series Number	Wt./100 (lbs.)	Shank Length (in.)	Inlet (in.)
31-202-04	31LF-202-04	43.00	5/8	3/4 MNPT
31-212-04	31LF-212-04	46.50	15/16	3/4 MNPT
31-501-04	31LF-501-04	31.00	5/8	1/2 MNPT/1/2 Sweat

Water Heater Drain Valves

BDT (31-400) SERIES



COMBINATION TEE & DRAIN VALVES

Permits supplying and draining of water through a single tank tapping and meets CSA requirements.

FEATURES

- All cast bronze bodies
- Aluminum handwheel
- No handle: Screwdriver slot stem option
- Max. rated pressure: 200 psig
- Max. rated temperature: 250° F
- 3/4" FNPT inlet x 3/4" male hose end x 3/4" FNPT side outlet
- Made in USA

Series Number	LF Series Number	Wt./100 (lbs.)	Handle
31-401-04	31LF-401-04	62.00	Aluminum Wheel - Red
31-401-04P	31LF-401-04P	62.00	Aluminum Wheel - Plain
31-401-13	31LF-401-13	62.00	Slotted Stem

PLUMBING SPECIALTIES

Water Heater Drain Valves

BD (31-600/31-700) SERIES



31-600
Male NPT



31-700
Female NPT

ANGLED BODY WATER HEATER DRAIN VALVES

All drains are equipped with Conbraco packing seal assuring easy turning stem and leak proof drain. Various shank lengths available. Meets CSA requirements.

FEATURES

- All cast bronze bodies
- Max. rated pressure: 200 psig
- Max. rated temperature: 250° F
- 31-600: 3/4" MNPT inlet
- 31-700: 1/2" or 3/4" FNPT inlet
- Made in USA

HANDLE SUFFIX KEY

-04	Aluminum Wheel - Red
-04P	Aluminum Wheel - Plain
-13	Slotted Stem

* Not all variations available in all sizes. Contact customer service.

Series Number	Shank Length (in.)	Inlet (in.)	Wt./100 (lbs.)
31-600	5/8"	3/4" MNPT	27.3
31-601	3/4"	3/4" MNPT	36.0
31-602	1"	3/4" MNPT	35.0
31-604	1-1/4"	3/4" MNPT	43.0
31-606	1-1/2"	3/4" MNPT	49.5
31-607	1-3/4"	3/4" MNPT	48.0
31-608	2"	3/4" MNPT	52.0
31-609	2-1/4"	3/4" MNPT	52.0
31-610	2-1/2"	3/4" MNPT	57.2
31-611	2-3/4"	3/4" MNPT	60.0
31-612	3"	3/4" MNPT	66.3
31-700		1/2" FNPT	39.0
31-701		3/4" FNPT	37.0

Water Heater Drain Valves

BD (35-300) SERIES

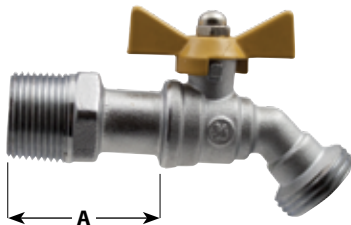

APOLLO INTERNATIONAL™ BALL VALVE BIBB FAUCET

Features heavy pattern with large opening. Ideal for boiler and water heater drains, general liquid dispensing and drainage. The new 45° spout design allows for easier hose connection access.

FEATURES

- Chrome plated finish; sizes 1/2" and 3/4"
- Pressure rating 200 psig liquid
- Maximum temperature 250°F

Series Number	Size (in.)	A (in.)	Inlet (in.)	Outlet (in.)	Wt./100 (lbs.)
35-301-03	1/2	1-1/2	1/2 sweat/thrd connector	0.75-11.5 NHR hose	38.4
35-302-03	3/4	1-3/4	3/4 thrd connector	0.75-11.5 NHR hose	44.5

WARRANTY INFORMATION

WARRANTY AND LIMITATIONS OF LIABILITY

Conbraco Industries, Inc. warrants, to its initial purchaser only, that its products which are delivered to this initial purchaser will be of the kind described in the order or price list and will be free of defects in workmanship or material for a period of **FIVE** years from the date of delivery to you, our initial purchaser. This warranty applies to Apollo brand product with "Made in the USA" markings only.

Should any failure to conform to this warranty appear within **FIVE** years after the date of the initial delivery to our initial purchaser, Conbraco will, upon written notification thereof and substantiation that the goods have been stored, installed, maintained and operated in accordance with Conbraco's recommendations and standard industry practice, correct such defects by suitable repair or replacement at Conbraco's own expense.

APOLLO INTERNATIONAL PRODUCTS: Conbraco Industries, Inc. warrants its International products, to its initial purchaser only, that its international products which are delivered to this initial purchaser will be of the kind described in the order or price list and will be free of defects in workmanship or material for a period of **TWO** years from the date of delivery to you, our initial purchaser.

THIS WARRANTY IS EXCLUSIVE AND IS IN LIEU OF ANY IMPLIED WARRANTY OF MERCHANTABILITY, FITNESS FOR A PARTICULAR PURPOSE OR OTHER WARRANTY OF QUALITY, WHETHER EXPRESSED OR IMPLIED, EXCEPT THE WARRANTY OF TITLE AND AGAINST PATENT INFRINGEMENT. Correction of non-conformities, in the manner and for the period of time provided above, shall constitute fulfillment of all liabilities of Conbraco to our initial purchaser, with respect to the goods, whether based on contract, negligence, strict tort or otherwise. It is the intention of Conbraco Industries, Inc. that no warranty of any kind, whether expressed or implied shall pass through our initial purchaser to any other person or corporation.

LIMITATION OF LIABILITY: Conbraco Industries, inc. SHALL NOT UNDER ANY CIRCUMSTANCES BE LIABLE FOR SPECIAL OR CONSEQUENTIAL DAMAGES SUCH AS, BUT NOT LIMITED TO, DAMAGES OR TO LOSS OF OTHER PROPERTY OR EQUIPMENT, LOSS OF PROFITS OR REVENUE, COST OF CAPITAL, COST OF PURCHASED OR REPLACEMENT GOODS, OR CLAIMS OF CUSTOMERS OF OUR INITIAL PURCHASER. THE REMEDIES OF OUR INITIAL PURCHASER, AND ALL OTHERS, SET FORTH HEREIN, ARE EXCLUSIVE, AND THE LIABILITY OF CONBRACO WITH RESPECT TO SAME SHALL NOT, EXCEPT AS EXPRESSLY PROVIDED HEREIN, EXCEED THE PRICE OF THE GOODS UPON WHICH SUCH LIABILITY IS BASED.

* It is the end user's responsibility to confirm that items intended for use satisfy local codes and standards.



TERMS AND CONDITION OF SALE

- Payment: 2% 10th prox. Net 30 days.
- All prices F.O.B. shipping point with freight allowed on shipments of 750 pounds and/or \$5,000 net minimum to all shipping points within the United States excluding Alaska and Hawaii. No freight allowed on Air Freight or Parcel Post shipments. Claims for shortages must be made within 10 days of receipt of material. Our responsibility ends when a receipt is furnished us by the carrier.
- No Invoice Rendered For Less Than \$50.00.
- No freight will be allowed on Air Freight, Air Express, Parcel Post or U.P.S. shipments.
- All Conbraco products may be combined to make sufficient weight for full freight allowance.
- Phone order quoted prices are subject to correction. Prices and designs are subject to change without notice.
- Orders for material or special design or specification are made to customer's order and are not subject to cancellation or return.
- All goods returned to us will not be accepted unless a full explanation has been made and our written authorized permission obtained in advance. All goods returned – if accepted – will be credited at invoice price, less 30% for service and rehandling charges, plus shipping expenses.
- We reserve the right to adjust orders to box quantities.

APOLLO VALVES & ELKHART PRODUCTS SALES MANAGERS & INTERNATIONAL SALES MANAGERS

	AREAS COVERED	EMAIL	PHONE	FAX
DIRECTOR OF INDUSTRIAL SALES				
Mike Green	Industrial	mike.green@conbraco.com	704-841-6039	704-841-6021
REGIONAL SALES MANAGERS – INDUSTRIAL				
Dave Eck	Northeast	david.eck@conbraco.com	302-268-4411	
JR Fortenberry	Mountain States	jr.fortenberry@conbraco.com	480-824-8288	
Ken Griffin	Southeast	ken.griffin@conbraco.com	704-621-9296	704-841-6021
Jim Todman	Canada	jim.todman@conbraco.com	905-407-8385	905-761-6666
Skip Wilson	West	skip.wilson@conbraco.com	760-518-2222	775-854-5722
COMMERCIAL SALES MANAGERS – APOLLO VALVES & ELKHART PRODUCTS				
Kevin Ashworth	National Project Mgr. - Commercial	kevin.ashworth@conbraco.com	757-272-6200	
Brian Blalock	Director of National Sales - Valves	brian.blalock@conbraco.com	704-614-3744	704-841-6021
Brian Fiorisi	Project Mgr. - Pex & Fittings	brian.fiorisi@conbraco.com	574-524-6675	
Todd Green	National Sales Mgr. - APOLLOXPRESS® - West	todd.green@conbraco.com	501-920-2029	
John Hembree	Sales Mgr. - Push Product	john.hembree@conbraco.com	678-618-8471	
Sean Perry	Sales Mgr. - Fire Protection & Waterworks	sean.perry@conbraco.com	704-641-9167	
Robert Purchia	National Sales Mgr. - APOLLOXPRESS® - East	robert.purchia@conbraco.com	704-960-3532	
Cary Wiley	Sales Mgr. - Fire Protection & Waterworks	cary.wiley@conbraco.com	678-642-3356	
REGIONAL SALES MANAGERS – COMMERCIAL				
Keith Baca	Southeastern	keith.baca@conbraco.com	615-630-3892	
Steve Brown	Northwestern	steve.brown@conbraco.com	425-985-5095	253-862-3548
Andy Fretz	Canada	andy.fretz@conbraco.com	647-281-3161	905-761-6666
Ben Lauletta	Northeastern	ben.lauletta@conbraco.com	518-795-4629	
Nick Shelley	Central	nick.shelley@conbraco.com	214-790-4157	
Jeremy Swirck	Southwestern	jeremy.swirck@conbraco.com	714-296-5346	
LASCO FITTINGS REGIONAL SALES MANAGERS – IRRIGATION				
David Beyer	Northeast	dbeyer@lascofittings.com	561-718-9379	
Don Caver	Central	dcaver@lascofittings.com	469-628-4918	
Ben Freeman	Southeast	bfreeman@lascofittings.com	205-919-4944	
Bryan Jackman	West	bjackman@lascofittings.com	714-673-5875	
Jimmy White	National Sales Manager	jwhite@lascofittings.com	731-234-2372	
Rick Williamson	Eastern Specifications Manager	rwilliamson@lascofittings.com	386-451-2307	
INTERNATIONAL SALES REPS				
Jose Arias	Mexico	jose.arias@conbraco.com	1-956-631-4542	1-956-631-4681
Erick de Miranda	Asia & the Caribbean	erick.demiranda@conbraco.com	1-720-383-8757	
JR Jefferson	Central & South America	jr.jefferson@conbraco.com	1-832-220-3783	
Luke Liu	China	luke.liu@conbraco.com	86-411-869-02498	
Brencliff Group	Australia, New Zealand	petermcl@brencliff.com	61 477 223110	
Pegler Yorkshire	United Kingdom	adrian.byrne@conbraco.com	44-7740-449858	
Pegler Yorkshire Mid East	Middle East/India	peter.pydubai@gmail.com	971-4-454-2353	971-4-454-2352
	Europe/Africa/Israel	customersupport@conbraco.com	1-704-841-6000	1-704-841-6021

current as of 5/28/14



For additional information, submittal sheets and manuals, visit www.apollovalves.com

Customer Service (704) 841-6000



SALES & CUSTOMER SERVICE:

Phone: (704) 841-6000 Fax: (704) 841-6020

www.apollovalves.com

APOLLO VALVES COMMERCIAL REPS

	AGENCY	AREAS COVERED	EMAIL	PHONE	FAX
SOUTHEAST	SOUTHEAST REGION REPS				
	Mid South Marketing, Inc.	VA/MD/Washington DC/WV-East	michael.uecker@msmsales1.com	804-213-3801	804-213-3802
	Midwest Spec	Southern OH, KY	rvsales@mwspec.com	800-755-7732	513-353-1589
	Pro Marketing, Inc.	NC/SC/TN-East	sales@promarketinginc.net	864-578-4334	864-578-4889
	Spirit Group	FL (except Panhandle)	info@spiritgroupinc.com	407-291-6035	407-299-0378
	Tim Morales & Associates, Inc.	AL/LA/FL Panhandle	sales@timmorales.com	251-602-8333	251-602-8339
	White Wolf Group	GA	info@whitewolfgroupinc.com	800-401-4870	888-908-9372
NORTHEAST	NORTHEAST REGION REPS				
	Conroy & Griese Sales, Inc.	NY-East/NJ-North	iezzi52@aol.com	856-429-2660	856-429-2230
	Layden Company	NY-Upstate/PA-East/DE/NJ-South	joejr@laydencompany.com	610-363-6657	877-529-3361
	Midwest Spec	Northern OH, Western PA, WV	glsales@mwspec.com	330-538-0406	330-538-0410
	Urell, Inc.	MA/New England States	apollo@urell.com	617-923-9500	617-926-9414
	V.E. Sales Co., Inc.	MI (Except Upper Peninsula)	tomv@vesalesinc.com	586-774-7760	586-774-1490
CENTRAL	CENTRAL REGION REPS				
	Big Rivers Marketing LLC	KS except Northeast	trosner@bigriversllc.com	800-727-3057	816-214-9017
	New Tech Marketing	Northern-IL/WI-East/IN/MI-UP/IA-River Counties	sales@new-techmarketing.com	630-378-4300	630-378-0343
	New Tech Marketing	MO/Southern IL/Northeast Kansas	ntm112@aol.com	618-394-0329	618-394-0427
	NSC Marketing Group Inc.	OK	nsc_tulsa@sbcglobal.net	918-627-5340	918-664-1408
	PEPCO Sales & Marketing	TX	is@pepcosales.com	972-823-8700	972-823-8717
	Southern Marketing Group	MS/TN-West/AR/Bowie Cty.-TX	SMG49@bellsouth.net	901-547-0042	901-547-0035
NORTHWEST	NORTHWEST REGION REPS				
	FourMation Sales	MN/ND/SD/WI-West	ryan@fourmationsales.com	763-420-6900	763-420-6993
	Gordon & Associates	WA, OR, AK, Northern counties ID, HI	laura@gordonandassoc.com	360-566-1470	360-566-1478
	Marshall-Rodeno Heartland	NE/IA (Except River Counties)	dnaylor@marshallrodeno.com	303-575-6701	303-575-6706
SOUTHWEST	SOUTHWEST REGION REPS				
	Elmco Duddy	CA - South	tduddy@elmcoduddy.com	626-333-9942	626-855-4811
	HC Fletcher	CA - North	apollosales@hcfletcher.com	800-432-7047	949-660-9072
	Marshall-Rodeno Associated	ID-SE, NV-NE, UT, CO, MT, NM	dnaylor@marshallrodeno.com	303-575-6701	303-575-6706
	Southwest Valves	CA (Waterworks)	c.burell@southwestvalve.com	559-261-2703	559-261-2711
	Southwestern Industrial Sales Co.	AZ, Nevada (except NE)	sales@sw-ind.com	480-458-5838	480-458-5843
CANADA	CANADA REPS				
	Barclay Sales Ltd.	British Columbia	jblair@barclaysales.com	604-945-1010	604-945-3030
	Conbraco Industries, Canada	178 Pennsylvania Ave., Unit 1, Concord, Ontario L4K 4B1	conbraco.canada@conbraco.com	905-761-6161	905-761-6666
	D & M Mechanical Sales	Ontario/East	don@dandmsales.ca	613-384-7084	613-384-3407
	Dynamic Agencies, Ltd.	Saskatchewan	doug.dynamicage@sasktel.net	306-343-1901	306-343-1901
	J. Levandier Sales, Inc.	NS, NB, PE & NL	vickie@jevandiersales.com	506-858-1615	506-858-1084
	Kern Industries, Ltd.	Alberta-North	colin@kernind.com	780-451-2056	780-454-6687
	Kern Industries Calgary, Ltd.	Alberta-South	kerncalgary@telus.net	403-730-7791	403-239-8179
	Key to the North Sales Agency, Inc.	Ontario-North	office@keytothenorth.net	705-867-1401	
	Task Controls, Inc.	Ontario-South	infotoronto@taskcontrols.com	416-291-3004	416-754-3481
	Tom Beggs Agencies Ltd.	Manitoba/NW Ontario	tba@mymts.net	204-953-1900	204-774-6915
Ventes Techniques Nimatec, Inc.	Quebec	nimatec@nimatec.com	450-691-9427	450-691-4949	
IRRIGATION ONLY	IRRIGATION REPS				
	Active Sales Northwest, Inc.	OR, WA, Western ID	stevek@activesalesnw.com	541-726-0320	541-726-1148
	Biz Sales Company	OH, KY, MI, IN, parts of WI	dzavelson@bizpvf.com	216-595-2888	216-595-2899
	Blake Bradbury	TX - Southern, LA, MS - Southern	bbradbury@lascofittings.com	713-594-5603	
	Brandon Nairn	TX - Northern	bnairn@lascofittings.com	972-333-1855	
	Burnley & Associates	DC, PA, DE, VA, MD, and WV	kerryb@burnleyassociates.com	610-842-7381	
	Fourmation Sales	MN/ND/SD/WI-West	dean@fourmationsales.com	763-262-4700	763-262-4740
	Gentile & Associates	CA, HI, NV, Mexico	tgentile@gentileandassociates.com	951-461-0942	951-461-1643
	John Hart	FL	jhart@lascofittings.com	772-595-7773	
	Marel Enterprises	NH, ME, CT, RI, NY	marelenterprisegmail.com	631-271-1718	631-427-8558
	Marsh & Moore	GA	jaustin@marshmoore.com	352-321-7499	904-827-8795
	Marshall-Rodeno Associated	CO, WY, MT, ID-SE, UT, NV-NE, NE, IA	dnaylor@marshallrodeno.com	303-575-6701	303-575-6706
	NSC Marketing Group Inc.	OK	nsc_tulsa@sbcglobal.net	918-627-5340	918-664-1408
	Pro Marketing, Inc.	NC/SC/TN-East	sales@promarketinginc.net	864-578-4334	864-578-4889
	Ryan Schuler	MO, KS, AR, IL, WI, TN - West & Middle, MS - North	rschuler@lascofittings.com	502-468-0384	
	Tim Morales & Associates, Inc.	AL	sales@timmorales.com	251-602-8333	251-602-8339
	VPC Sales	AZ, NV	chudson@vpcsales.com	661-257-3923	661-257-3928