

# Door Gaskets

## Four Piece Magnetic Universal Door Gaskets

Four styles of the most commonly used magnetic door gasket kits. Designed residential and commercial refrigerator / freezer applications where a direct replacement gasket is not available. The illustrated cross sections show the four most popular profiles used where the clearance  $5/8"$  to  $3/4"$ . Each gasket is furnished with (4) L-shaped sections complete with factory welded corners. The magnetic insert strip is furnished in a roll. Both the gasket and magnetic strip can be easily cut to size. Available in a variety of sizes. All of the gaskets are made from refrigeration grade 100% virgin vinyl and is FDA acceptable.



Supco No.	Color	Maximum Door Size
SGE421	Brown	10" X 75 1/2"
SGE422	White	10" X 75 1/2"
SGE432	Brown	20" X 62 1/2"
SGE433	White	20" X 62 1/2"

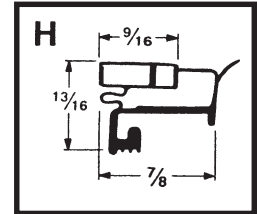

Supco No.	Color	Maximum Door Size
SU2001	White	20" X 30"
SU2002	White	32" X 42"
SU2003	White	32" X 55"
SU2004	White	36" X 84"

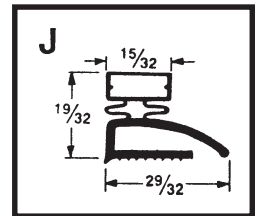

Supco No.	Color	Maximum Door Size
SU2101	White	20" X 30"
SU2102	White	32" X 42"
SU2103	White	32" X 55"
SU2104	White	36" X 84"
SU2105	White	10" X 75 1/2"
SU2106	White	20" X 62 1/2"

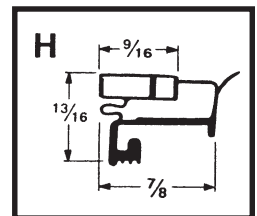

Supco No.	Color	Maximum Door Size
SU2301	White	20" X 30"
SU2302	White	32" X 42"
SU2303	White	32" X 55"
SU2304	White	36" X 84"

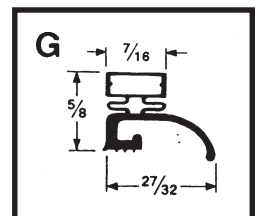

# Door Gaskets

## Direct Replacement Refrigerator Door Gaskets

The most common direct replacement door gaskets. A variety of profiles, sizes and colors. An alternate universal gasket kit is listed for convenience. All of the gaskets are made from refrigeration grade 100% virgin vinyl and is FDA acceptable.

### Electrolux Direct Replacement Door Gaskets

OEM No.	Supco No.	Profile	Dimensions	Color	Universal Kit No.
215019104	SWC49	V	11 13/16 X 19 1/4	(TN)	
218730603	SWC26	V	27 3/4 X 44	(WH)	SU2103
218730604	SWC41	V	27 1/2 X 44	(BR)	
218730609	SWC22	V	30 5/8 X 44	(WH)	SU2103
218730610	SWC12	V	30 3/8 X 44 1/8	(TN)	
5300280162	SWE58	X	28 7/16 X 55	(WH)	
5300624974	SFR100	D	19 1/4 X 60 1/8	(WH)	SU221
5301124534	SFR85	D	13 1/4 X 28 5/8	(WH)	SU2301
5303207345	SWC61	V	29 X 43 7/8	(WH)	SU2103
5303288856	SWC55	V	16 11/16 X 27 5/8	(BR)	
5303297557	SWC58	V	27 5/8 X 43	(BR)	
5304404033	SGI47	V	30 7/16 x 40 1/8	(WH)	SU2102
5307512516	SFR75	D	30 1/2 X 53 1/4	(WH)	SU2303
5308007115	SGI46	V	30 1/4 x 41 1/2	(WH)	
5308007123	SWC20	V	16 11/16 X 27 5/8	(WH)	SU2101
5318680302	SWC21	V	27 5/8 X 43	(WH)	SU2103
5318680305	SWC23	V	13 1/2 X 21 1/2	(WH)	SU2101
5303271473	SWC66	V	27 1/2 X 39 3/4	(WH)	SU2102
6007-356-6	SPH52	L&M	14 1/8 x 29 7/16	(WH)	SU2301
6007-356-7	SPH53	L&M	29 7/16 X 39 3/4	(WH)	SU2302
K001205008	SKL36	G	28 1/2 x 42	(WH)	SU2302

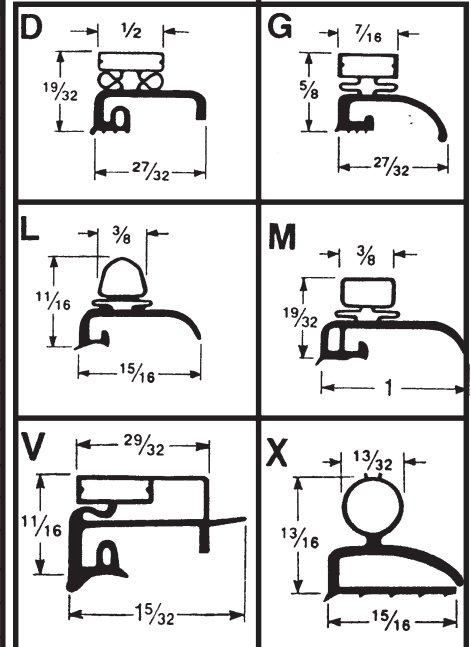

### General Electric Direct Replacement Door Gaskets

OEM No.	Supco No.	Profile	Dimensions	Color	Universal Kit No.
WR24X246	SGE108	H	19 3/4 X 60 1/8	(WH)	SGE433
WR24X267	SGE117	U	18 5/8 X 28 1/8	(WH)	SU2301
WR24X271	SGE126	AB	28 3/8 X 40	(WH)	SU2302
WR24X272	SGE125	AB	28 1/4 X 41 1/2	(WH)	SU2302
WR24X273	SGE112	S	19 1/2 X 28 7/8	(WH)	SU2301
WR24X274	SGE111	S	29 X 39 3/8	(WH)	SU2302
WR24X284	SGE284	N&P	28 1/2 X 39 1/2	(BR)	
WR24X286	SGE286	F	17 1/8 x 26 3/16	(BR)	
WR24X287	SGE287	E	26 7/16 x 36 3/4	(BR)	
WR24X295	SGE295	H	19 5/8 X 59 7/8	(BR)	SGE432
WR24X300	SGE300	H	19 1/8 x 28 3/4	(BR)	SGE432
WR24X301	SGE301	A	28 5/8 X 38	(BR)	
WR24X302	SGE302	H	19 1/2 X 28 3/4	(WH)	SU2101
WR24X303	SGE303	A	28 1/2 X 38	(WH)	SU2302
WR24X309	SGE309	A	31 1/8 X 38	(BR)	
WR24X311	SGE311	N	31 1/4 X 38 1/8	(WH)	SU2302
WR24X312	SGE312	F	17 1/8 x 26 3/16	(WH)	SU2301
WR24X313	SGE127	E	26 1/4 X 36 1/2	(WH)	SU2302
WR24X315	SGE110	H	17 1/4 X 57 7/8	(WH)	SGE433
WR24X318	SGE318	A	26 1/8 X 39 3/4	(BR)	
WR24X319	SGE319	A	26 1/4 X 39 3/4	(WH)	SU2002
WR24X390	SGE390	A	32 5/8 X 38	(BR)	
WR24X421	SGE421	H	KIT 10 X 75 1/2	(BR)	SGE421

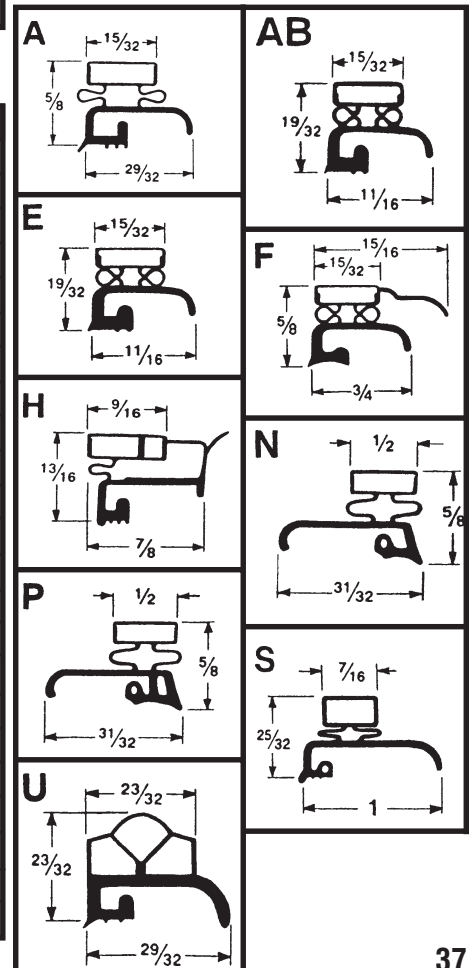

# Door Gaskets

## General Electric Direct Replacement Door Gaskets (continued)

OEM No.	Supco No.	Profile	Dimensions	Color	Universal Kit No.
WR24X422	SGE422	H	KIT 10 X 75 1/2	(WH)	SGE422
WR24X432	SGE432	H	KIT 20 X 62 1/2	(BR)	SGE432
WR24X433	SGE433	H	KIT 20 X 62 1/2	(WH)	SGE433
WR24X437	SGE437	AJ	32 5/8 X 39 3/8	(WH)	
WR24X438	SGE438	AJ	21 1/8 X 32 7/16	(WH)	
WR24X446	SGE446	AJ	29 3/16 x 38 3/4	(WH)	
WR24X449	SGE449	AJ	18 7/8 x 27 1/4	(WH)	
WR24X450	SGE450	AJ	27 1/4 x 38 5/8	(WH)	
WR24X454	SGE454	H	18 1/4 X 26 3/4	(BR)	SGE432
WR24X464	SGE464	H	19 5/8 X 60 9/16	(BR)	SGE432
WR24X481	SGE481	AJ	26 1/2 X 37 7/8	(BR)	
WR24X484	SGE484	AJ	16 5/8 X 26	(WH)	
WR24X485	SGE485	AJ	26 1/8 X 37 15/16	(WH)	
WR24X486	SGE486	AJ	25 15/16 X 41	(WH)	
WR24X5013	SGE107	S	26 7/16 X 40 3/4	(WH)	SU2002
WR24X5015	SGE5015	AG	27 X 45 3/4	(WH)	
WR24X517	SGE517	U	KIT 67 X 67	(WH)	SGE517
WR24X5231	SGE5231	H	19 3/4 X 60	(WH)	SGE433
WR24X5232	SGE5232	H	17 3/8 X 60	(WH)	SGE433
WR24X524	SGE524	AJ	16 5/8 X 26 1/16	(WH)	
WR24X528	SGE528	H	17 3/4 X 60	(WH)	SGE433
WR24X558	SGE558	AJ	26 X 43 1/16	(WH)	
WR24X10049	SGE485	AJ	26 1/8 X 37 15/16	(WH)	SGE485
WR24X10050	SGE484	AJ	16 5/8 X 26	(WH)	SGE484

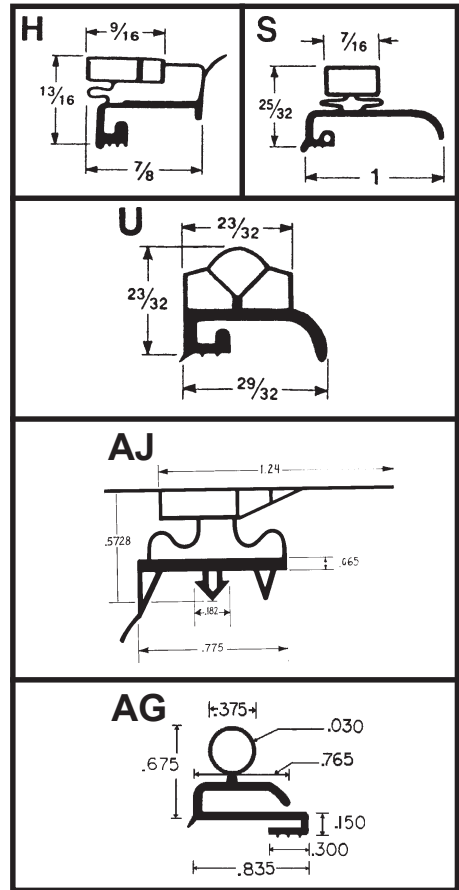

## Maytag Direct Replacement Door Gaskets

OEM No.	Supco No.	Profile	Dimensions	Color	Universal Kit No.
10359709Q	SAM63	AE	14 1/4 X 61	(WH)	SU2106
12550101Q	SAM54	AE	23 3/4 X 31	(BK)	
12550109Q	SAM55	AE	28 1/2 X 39 3/4	(WH)	SU2102
12550111Q	SAM56	AE	31 1/2 X 41 1/2	(WH)	SU2102
12550112Q	SAM57	AA	18 7/8 X 31 1/4	(WH)	SU2102
12550115Q	SAM58	AE	31 1/4 X 37 3/4	(WH)	SU2102
12550116Q	SAM59	AE	23 1/2 X 31 1/4	(WH)	SU2102
24157-12	SAD38	T	20 5/8 X 58 1/2	(WH)	
56287-11	SAD77	T	15 11/16 X 28 1/8	(WH)	
66929-31	SAD76	C	18 X 60 5/8	(WH)	SU2004
66929-32	SAD82	AF	28 X 38 7/8	(WH)	SU2102
70025-2	SAD99	C	27 3/8 X 35 3/8	(WH)	SU2002
70025-4	SAD97	C	27 3/8 X 38	(WH)	SU2002
70025-5	SAD100	C	19 1/8 X 29 7/8	(WH)	SU2001
70025-6	SAD101	C	30 X 37 7/8	(WH)	SU2002
70047-1	SAD67	AA	16 3/8 X 28 1/4	(WH)	SU2101
70047-2	SAD69	AA	18 7/16 X 28 1/4	(WH)	SU2101
70047-3	SAD71	AA	19 3/8 X 30 3/4	(WH)	SU2102
70048-1	SAD68	AA	28 1/4 X 36 5/8	(WH)	SU2102
70048-2	SAD70	AA	28 1/4 X 39 1/8	(WH)	SU2102

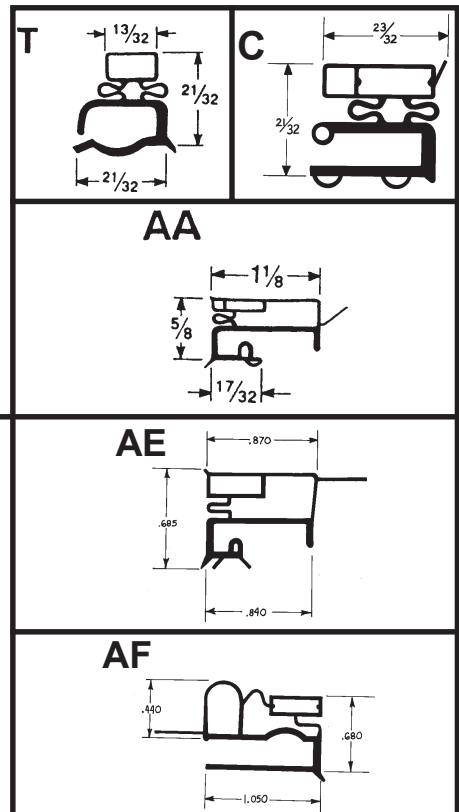

# Door Gaskets

## Maytag Direct Replacement Door Gaskets (continued)

OEM No.	Supco No.	Profile	Dimensions	Color	Universal Kit No.
70048-3	SAD72	AA	30 3/4 X 39 1/8	(WH)	SU2102
70048-4	SAD73	AA	32 1/4 X 39 1/8	(WH)	SU2104
70048-5	SAD81	AF	27 7/8 X 36 1/4	(WH)	SU2102
D3928207Q	SAM32	D	30 7/16 x 43	(WH)	SU2303
D7092602Q	SAM29	D	20 5/16 X 61 13/32	(WH)	SU2213
D7092608Q	SAM41	D	20 1/4 X 61 3/8	(WH)	SU2213
D7605106Q	SAM43	AE	17 1/2 X 30 3/4	(WH)	SU2102
D7605107Q	SAM44	AE	30 3/4 X 39 1/4	(WH)	SU2102
D7605108Q	SAM33	AE	19 1/4 X 30 3/4	(WH)	SU2102
D7605109Q	SAM34	AE	30 7/8 X 40 1/2	(WH)	SU2102
D7605110Q	SAM35	AE	24 X 30 3/4	(TN)	
D7605115Q	SAM39	AE	24 1/8 X 31	(WH)	SU2102
D7605116Q	SAM40	AE	30 5/8 X 35 5/8	(WH)	SU2102

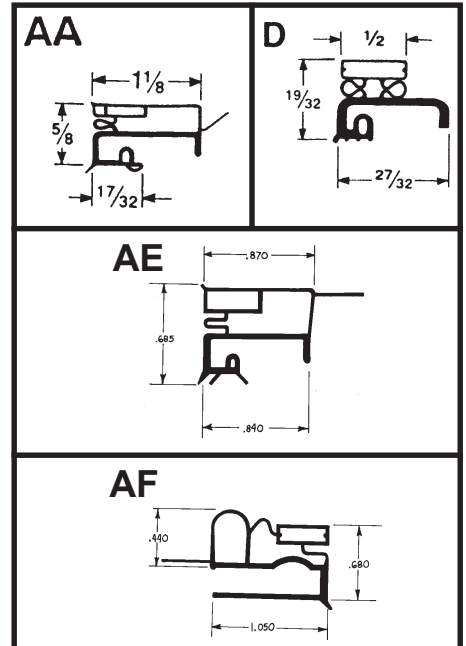

## Whirlpool Direct Replacement Door Gaskets

OEM No.	Supco No.	Profile	Dimensions	Color	Universal Kit No.
510345	SCS27	L&M	30 X 39 1/2	(WH)	SU2213
576664	SCS108	AK	26 1/2 X 58 1/2	(WH)	SU2213
592945	SCS115	AK	27 X 42 1/2	(WH)	SU2213
4343449	SCS107	V	30 1/2 X 43	(WH)	SU2102
2188404A	SCS105	F	19 1/8 X 58 7/8	(WH)	SU2213
2188404A	SCS105	F	19 1/8 X 58 7/8	(WH)	SU2213
2188404A	SCS44	F	19 1/8 X 59 1/32	(WH)	SU2213
2188405A	SCS79	F	11 3/8 X 59 1/8	(WH)	SU2213
2188433A	SCS116	F	19 1/4 X 62 1/4	(WH)	SU2213
2188434A	SCS97	F	14 5/8 X 62 1/8	(WH)	SU2213
2188444A	SCS75	F	30 1/4 X 42 3/8	(WH)	SU2213
2188445A	SCS115	F	27 X 42 1/2	(WH)	SU2213
2188445A	SCS71	F	27 7/16 X 42 5/8	(WH)	SU2213
2188446A	SCS98	F	23 1/8 X 42 1/8	(WH)	SU2213
2188447A	SCS99	F	28 X 40 1/8	(WH)	SU2213
2188448A	SCS112	F	27 1/16 X 39 7/8	(WH)	SU2213
2188450A	SCS42	F	31 13/32 X 39 1/8	(WH)	SU2213
2188450A	SCS42	F	31 13/32 X 39 1/8	(WH)	SU2213
2188451A	SCS46	F	28 13/32 X 39 1/8	(WH)	SU2213
2188456A	SCS102	F	16 1/2 X 26 3/4	(WH)	SU2213
2188458A	SCS103	F	21 1/2 X 31 3/8	(WH)	SU2213
2188460A	SCS92	F	18 7/8 X 31 3/4	(WH)	SU2213
2188461A	SCS100	F	18 5/8 X 28 1/8	(WH)	SU2213
2188464A	SCS93	F	16 1/2 X 23 1/4	(WH)	SU2213

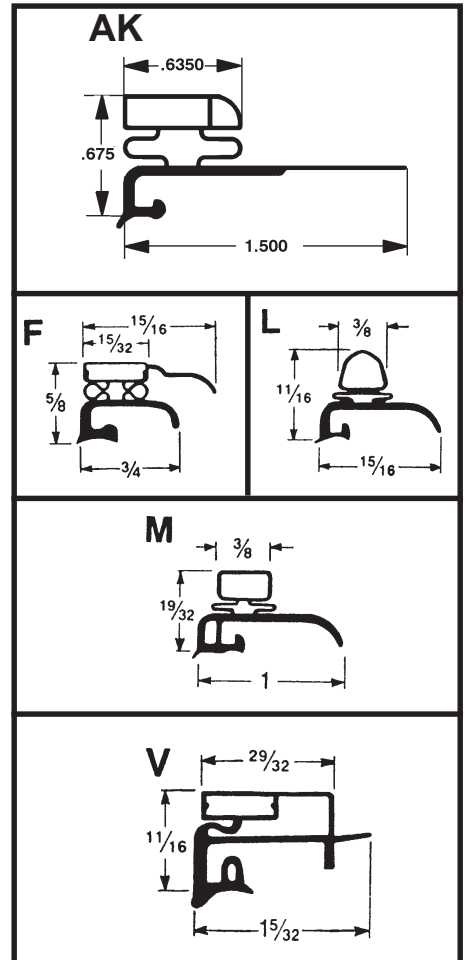

# Refrigerator Door Gasket Cross Reference

Electrolux			Electrolux (Cont.)			Electrolux (Cont.)			Electrolux (Cont.)		
OEM No.	Supco No.	Universal Kit	OEM No.	Supco No.	Universal Kit	OEM No.	Supco No.	Universal Kit	OEM No.	Supco No.	Universal Kit
00622115		SU2213	08015544	SWC12		3200832		SU2106	5307541122		
00623575		SU2213	08016563		SU2102	3201013		SU2106	5307545059		SU2213
00623576		SU2213	08016625	SWC58		3201811		SU2106	5308007104	SGI47	SU2102
00623577		SU2213	08016626	SWC55		5300280162	SWE58		5308007114		SU2102
00624971		SU2213	08016627		SU2102	5300280163	SWE55		5308007115	SGI46	SU2102
00624974	SFR100	SU2213	08016628		SU2101	5300412101		SU2213	5308007122	SWC21	SU2103
00626287		SU2213	08017430	SWC49		5300412103		SU2302	5308007123	SWC20	SU2101
00627250	SFR85	SU2213	08017487	SWC12		5300462603		SU2213	5308007124		SU2102
00627766		SU2213	186803-03		SU2101	5300622114		SU2213	5308007229		SU2106
00627857		SU2213	215018201		SU2106	5300622929		SU2213	5308010244	SWC55	
00628042		SU2213	215019104	SWC49		5300622930		SU2213	5308010756		SU2102
00628810		SU2213	215608901	SWC55		5300624971		SU2213	5308011239		SU2102
00628817		SU2213	215608911	SWC20	SU2101	5300624974	SFR100	SU2213	5308015544	SWC12	
01124342		SU2213	215608912		SU2101	5300624975		SU2213	5308016563		SU2102
01124477		SU2213	215608913		SU2102	5300627766	SWC19	SU2301	5308016627		SU2102
01124534	SFR85	SU2213	215608916		SU2301	5300627857		SU2213	5308016628		SU2101
01124647		SU2213	215608931	SWC55		5300628042		SU2213	5308017430	SWC49	
01124648		SU2213	215608941	SWC20	SU2101	5300628810		SU2213	5308017487	SWC60	
01137863	SFR100	SU2213	215608943		SU2102	5300661994		SU2102	5314220908		SU2213
01138694	SFR100	SU2213	215608961	SWC55		5301124534	SFR85	SU2213	5315282802		SGE433
07510058		SU2213	215608963		SU2102	5301205009		SU2213	5315627301		SU2213
07512516	SFR75	SU2213	215608971	SWC20	SU2101	5301207363		SU2213	5317532406		SU2102
07512518		SU2213	215732401	SWC58		5301207364		SU2213	5317532408		SU2102
07512520		SU2102	215732402	SWC41		5303001304	SWC55		5317532506		SU2106
07516628	SFR75	SU2213	215732403	SWC12		5303001398	SWC58		5318680302	SWC21	SU2103
07516629	SFR75	SU2213	215732411	SWC21	SU2103	5303001399	SWC55		5318680305	SWC23	SU2101
07516633		SU2213	215732412	SWC26	SU2103	5303001517	SWC41		5318680311	SWC26	SU2103
07541121	SFR85	SU2213	215732413	SWC59	SU2103	5303017373	SWC41		5318680314		SU2102
07541122		SU2213	215732461	SWC58		5303018555	SWC22	SU2103	5318693207	SGI47	SU2102
07544249		SU2213	215732462	SWC41		5303018791		SU2101	53337	SWC58	
07544341		SU2213	215732463	SWC12		5303018792	SWC22	SU2103	53338	SWC55	
07544342	SFR75	SU2213	215740401		SU2301	5303200258	SWC20	SU2101	53339	SWC41	
07544594		SU2213	215740402		SU2302	5303200274	SWC49		53900	SWC12	
07544595		SU2213	215776701	SWC55		5303200799	SWC49		6007-356-1		SU2213
07545059		SU2213	215776711	SWC20	SU2101	5303200832		SU2106	6007-356-2		SU2213
08000130		SU2102	215776761	SWC55		5303201013		SU2106	6007-356-3		SU2213
08000131	SGI47	SU2102	218730603	SWC26	SU2103	5303206633		SU2102	6007-356-4		SU2213
08000289		SU2102	218730604	SWC41		5303206641	SWC22	SU2103	6007-356-6	SPH52	SU2301
08000290	SGI46	SU2102	218730604	SWC71		5303207112		SU2213	6007-356-7	SPH53	SU2302
08000795		SU2106	218730609	SWC22	SU2103	5303207113		SU2303	6007-356-8		SU2213
08000816	SWC21	SU2103	218730609	SWC59	SU2103	5303207115		SU2213	6007-356-9		SU2213
08000817	SWC20	SU2101	218730610	SWC12		5303207345	SWC61	SU2103	6007-356-11		SU2213
08000998		SU2106	2656D45A01		SU2213	5303271473	SWC66	SU2102	622931		SU2213
08001010		SU2102	2657D67A01		SU2213	5303275771	SWC22	SU2103	622970		SU2213
08001011		SU2101	2657D67A02		SU2213	5303275772	SWC12		626288		SU2213
08003887		SU2213	2658D36A02		SU2213	5303275788		SU2102	627251		SU2213
08007103		SU2102	2659D52A01		SU2213	5303276825		SU2101	627766		SU2213
08007104	SGI47	SU2102	2659D52A03		SU2213	5303280061		SU2102	63442-6		SU2102
08007114		SU2102	2659D52A04		SU2303	5303288856	SWC55		6583286		SU2213
08007115	SGI46	SU2102	2659D79A02		SU2213	5303288857	SWC41		66199-4		SU2102
08007122	SWC21	SU2103	3001304	SWC55		5303297557	SWC58		7546760		SU2213
08007123	SWC20	SU2101	3001317	SWC58		5303299394	SWC61	SU2103	86605	SWC58	
08007124		SU2102	3001398	SWC58		5304404033	SGI47	SU2102	86607		SU2102
08007125		SU2101	3001399	SWC55		5304404034		SU2102	86609	SWC41	
08007229		SU2106	3001416	SWC12		5304404035		SU2101	C000069003	SWE58	
08007230		SU2106	3001517	SWC41		5304404036		SU2102	C000069013	SWE58	
08009733	SWC41		3007136		SU2106	5304404037		SU2102	C000089757	SWE58	
08009735	SWC12		3017373	SWC41		5306583289		SU2213	C000094054		SU2303
08010243	SWC58		3018238	SWC12		5307112517		SU2213	C000094059		SU2213
08010244	SWC55		3018555	SWC22	SU2103	5307510058		SU2213	C000094060		SU2213
08010245		SU2102	3018633		SU2106	5307510063		SU2213	C000094062		SU2213
08010246		SU2101	3018791		SU2101	5307512516	SFR75	SU2213	C000094063		SU2213
08010247		SU2106	3018792	SWC22	SU2103	5307512518		SU2213	C000280162	SWE58	
08010249	SWC49		3200258	SWC20	SU2101	5307512519		SU2213	C000460495		SU2213
08010755	SGI47	SU2102	3200261	SWC26	SU2103	5307512520		SU2102	C000460825		SU2213
08010756		SU2102	3200274	SWC49		5307514191		SU2213	C280162	SWE58	
08011239		SU2102	3200799	SWC49		5307516633		SU2213	G161588-01		SU2102

# Refrigerator Door Gasket Cross Reference

Electrolux (Cont.)			Electrolux (Cont.)			General Electric (Cont.)			General Electric (Cont.)		
OEM No.	Supco No.	Universal Kit	OEM No.	Supco No.	Universal Kit	OEM No.	Supco No.	Universal Kit	OEM No.	Supco No.	Universal Kit
G161588-02	SGI47	SU2102	K1205009		SU2213	WR24X168	SU2213	SGE517	WR24X281	SU2104	
G161588-03		SU2102	K1205010	SKL37	SU2301	WR24X169		SGE517	WR24X282	SGE517	
G161588-04	SGI46	SU2102	K1207363		SU2213	WR24X170		SGE517	WR24X283	SGE517	
G161588-06		SU2102	K1207364		SU2213	WR24X171		SGE517	WR24X284		SGE284
G161588-07	SWC23	SU2101	R000412101		SU2213	WR24X172		SGE517	WR24X286		SGE286
G161588-08	SWC21	SU2103	R000412103		SU2302	WR24X173		SGE517	WR24X287		SGE287
G161588-09	SWC20	SU2101	R000447303		SU2213	WR24X175		SGE517	WR24X288		SGE284
G165381-06		SU2106	R000462603		SU2213	WR24X176		SGE517	WR24X289	SGE421	SGE421
G165382-03		SU2106	R000901048		SU2102	WR24X177		SGE517	WR24X291		SGE421
G168930-02	SWC21	SU2103	R000901098	SWC12		WR24X178		SGE517	WR24X293		SGE432
G168930-03	SWC20	SU2101	R000901154	SWC41		WR24X179		SGE517	WR24X294		SGE432
G168930-04		SU2102	R009000103	SWC20	SU2101	WR24X181		SGE517	WR24X295	SGE295	SGE432
G168930-05	SWC23	SU2101	R009000110	SWC21	SU2103	WR24X182		SGE517	WR24X296		SGE432
G168930-06		SU2102	R186932-02	SWC58		WR24X191		SGE517	WR24X297		SGE432
G168930-07	SGI47	SU2102	R186932-03	SWC55		WR24X192		SGE517	WR24X298		SU2301
G168930-08		SU2102	R462603		SU2213	WR24X193		SGE517	WR24X299		SGE421
G168930-09	SGI46	SU2102	WR412101		SU2213	WR24X194		SGE517	WR24X300	SGE300	SGE432
G175324-02	SWC21	SU2103	WR412103		SU2302	WR24X200		SGE517	WR24X301	SGE301	
G175324-03	SWC20	SU2101	WR447303		SU2213	WR24X202		SGE517	WR24X302	SGE302	SU2101
G175324-04		SU2102	WR462603		SU2213	WR24X203	SGE117	SGE517	WR24X303	SGE303	SU2302
G175324-05	SWC23	SU2101				WR24X204		SGE517	WR24X304		SGE433
G175324-06		SU2102				WR24X205		SGE517	WR24X305	SGE305	SGE432
G175324-07	SGI47	SU2102				WR24X206		SGE517	WR24X306		SU2104
G175324-08		SU2102				WR24X207		SGE517	WR24X307		SU2104
G175324-09	SGI46	SU2102	WR14X5027		SGE433	WR24X212		SU2304	WR24X308	SGE308	SGE421
G175324-11	SWC26	SU2103	WR14X5034		SU2003	WR24X218		SGE422	WR24X309		SGE309
G175324-13	SWC22	SU2103	WR14X5035		SU2002	WR24X219		SGE422	WR24X310		SGE422
G175325-02		SU2106	WR14X5036		SGE422	WR24X220		SGE517	WR24X311	SGE311	SU2302
G175325-06		SU2106	WR14X5037		SGE422	WR24X221	SGE117	SGE517	WR24X312	SGE312	SU2301
G180547-02	SWC58		WR14X5038		SU2204	WR24X222		SGE517	WR24X313	SGE127	SU2302
G180547-03	SWC55		WR14X5039		SU2204	WR24X228		SGE517	WR24X314		SGE433
G180547-04		SU2102	WR14X5041		SU2204	WR24X229		SGE517	WR24X315	SGE110	SGE433
G180547-05		SU2101	WR24X10049	SGE485		WR24X230		SGE433	WR24X316		SU2104
G180547-06		SU2102	WR24X10050	SGE484		WR24X231		SGE433	WR24X317		SU2104
G180547-07	SGI47	SU2102	WR24X118		SGE517	WR24X232		SGE517	WR24X318		SGE318
G180547-08		SU2102	WR24X121		SGE517	WR24X233		SU2304	WR24X319	SGE319	SU2002
G180547-11	SWC41		WR24X122		SGE517	WR24X244		SGE433	WR24X334		SU2304
G180547-13	SWC12		WR24X124		SGE517	WR24X245		SGE433	WR24X389	SGE389	SGE421
G180551-01		SU2106	WR24X125		SGE517	WR24X246	SGE108	SGE433	WR24X390		SGE390
G180551-04	SWC49		WR24X129		SGE517	WR24X247		SGE433	WR24X391	SGE391	SGE422
G186556-03		SU2106	WR24X130		SGE517	WR24X248		SGE433	WR24X392	SGE392	SGE422
G186803-02	SWC21	SU2103	WR24X132		SGE517	WR24X249		SGE433	WR24X408		SU2104
G186803-03	SWC20	SU2101	WR24X134		SGE517	WR24X250	SGE112	SU2301	WR24X409		SU2104
G186803-04		SU2102	WR24X135		SGE517	WR24X251	SGE111	SU2302	WR24X410		SGE433
G186803-05	SWC23	SU2101	WR24X137		SGE517	WR24X252		SGE433	WR24X411		SGE432
G186803-11	SWC26	SU2103	WR24X138		SGE517	WR24X255	SGE112	SU2301	WR24X412		SGE433
G186803-12		SU2101	WR24X139		SGE517	WR24X256		SU2303	WR24X413		SGE287
G186803-13	SWC22	SU2103	WR24X141		SGE517	WR24X259		SU2303	WR24X414	SGE127	SU2302
G186803-14		SU2102	WR24X142		SGE517	WR24X260		SGE517	WR24X415		SGE432
G186932-02	SWC58		WR24X143		SGE517	WR24X261		SGE517	WR24X416		SGE432
G186932-03	SWC55		WR24X144		SGE517	WR24X262	SGE312	SU2301	WR24X418		SGE432
G186932-04		SU2102	WR24X148		SGE517	WR24X263	SGE127	SU2302	WR24X419		SGE432
G186932-05		SU2101	WR24X149		SGE517	WR24X265		SGE517	WR24X420		SGE432
G186932-06		SU2102	WR24X150		SGE517	WR24X266		SGE517	WR24X421	SGE421	SGE421
G186932-07	SGI47	SU2102	WR24X151		SGE517	WR24X267	SGE117	SGE517	WR24X422	SGE422	SGE422
G186932-08		SU2102	WR24X152		SGE517	WR24X268		SGE517	WR24X4	SGE424	SGE432
G186932-11	SWC41		WR24X153		SGE517	WR24X269		SGE517	WR24X427		SGE432
G186932-13	SWC12		WR24X154		SGE517	WR24X270		SU2301	WR24X428		SGE422
G191723-13	SWC22	SU2103	WR24X155		SGE517	WR24X271	SGE126	SU2302	WR24X429		SGE421
K001205007		SU2213	WR24X157		SGE517	WR24X272	SGE125	SU2302	WR24X430		SGE422
K001205008	SKL36	SU2302	WR24X159		SGE517	WR24X273	SGE112	SU2301	WR24X431		SGE318
K001205009		SU2213	WR24X160		SGE517	WR24X274	SGE111	SU2302	WR24X432	SGE432	SGE432
K1201771		SU2213	WR24X161		SGE517	WR24X275		SU2104	WR24X433	SGE433	SGE433
K1201772	SKL36	SU2302	WR24X162		SGE517	WR24X276		SU2102	WR24X437		SGE437
K1201773		SU2213	WR24X163		SGE517	WR24X277		SU2101	WR24X439		SGE301
K1205007		SU2213	WR24X164		SGE517	WR24X279		SU2104	WR24X440	SGE303	SU2302
K1205008	SKL36	SU2302	WR24X166		SGE517	WR24X280		SU2104	WR24X441		SU2104
			WR24X167		SGE517						

# Refrigerator Door Gasket Cross Reference

General Electric (Cont.)			Gemline			Gemline (Cont.)			Gemline (Cont.)		
OEM No.	Supco No.	Universal Kit	OEM No.	Supco No.	Universal Kit	OEM No.	Supco No.	Universal Kit	OEM No.	Supco No.	Universal Kit
WR24X446	SGE446		2001	SU2001	SU2001	CS59	SCS102	SU2301	GE168		SGE433
WR24X449	SGE449		2002	SU2002	SU2002	CS60	SCS115	SU2303	GE169		SGE433
WR24X450	SGE450		2003	SU2003	SU2003	FR105		SU2302	GE170		SGE433
WR24X454		SGE432	2004	SU2004	SU2004	FR106		SU2301	GE172	SGE392	SGE422
WR24X464	SGE464	SGE432	2301	SU2301	SU2301	FR112		SU2303	GE175		SGE432
WR24X472		SU2104	2301	SU2301	SU2301	FR113		SU2102	GE176	SGE424	SGE432
WR24X473		SGE432	2302	SU2302	SU2302	FR115		SU2106	GE177		SGE432
WR24X474		SGE432	2303	SU2303	SU2303	FR116	SWC20	SU2101	GE391	SGE391	SGE422
WR24X481	SGE481		2304	SU2304	SU2304	FR117	SWC59	SU2103	GE437	SGE437	
WR24X484	SGE484		AD38	SAD38	SU2204	FR118	SWC60		GE446	SGE446	
WR24X485	SGE485		AD51		SU2204	FR119	SWC71		GE449	SGE449	
WR24X486	SGE486		AD52		SU2204	FR119	SWC41		GE450	SGE450	
WR24X490		SU2213	AD53		SU2204	FR122		SU2101	GE464	SGE464	SGE432
WR24X5001	SGE108	SGE433	AD54		SU2204	FR26	SWC26	SU2103	GE485	SGE485	SGE485
WR24X5002		SGE433	AD55		SU2204	FR90	SWC61	SU2103	GE52		SGE517
WR24X5006		SGE433	AD57		SU2002	GE 42		SGE517	GE5231	SGE5231	SGE433
WR24X5010		SU2213	AD63		SU2004	GE107	SGE107	SU2002	GE5232	SGE5232	SGE433
WR24X5011		SU2213	AD64		SU2002	GE108	SGE108	SGE433	GE55		SGE517
WR24X5013	SGE107	SU2002	AD65		SU2002	GE109		SGE433	GE558	SGE558	
WR24X5023		SU2003	AD67	SAD67	SU2101	GE110	SGE110	SGE433	GE57		SGE517
WR24X5024		SGE422	AD68	SAD68	SU2102	GE111	SGE111	SU2302	GE68		SU2002
WR24X5068		SGE422	AD69	SAD69	SU2101	GE112	SGE112	SU2301	GE69		SU2002
WR24X5070		SU2302	AD70	SAD70	SU2102	GE113		SU2301	GE71		SU2003
WR24X5071		SU2302	AD71	SAD71	SU2102	GE115		SU2301	GE72		SU2003
WR24X51		SU2102	AD72	SAD72	SU2102	GE116		SGE517	GE73		SU2002
WR24X5103		SU2003	AD73	SAD73	SU2104	GE117	SGE117	SGE517	GE75		SU2001
WR24X5104		SU2204	AD74		SU2102	GE118		SGE517	GE76		SGE517
WR24X5105		SU2304	AD76	SAD76	SU2004	GE119		SGE517	GE77		SU2002
WR24X5109		SGE433	AD77	SAD77	SU2204	GE120		SU2303	GE78		SGE517
WR24X5112	SGE108	SGE433	AD77	SAD81	SU2102	GE121		SU2213	GE79		SGE517
WR24X5113		SGE433	AD78		SU2204	GE125	SGE125	SU2302	GE81		SGE517
WR24X5114		SGE433	AD79	SAD79	SU2002	GE126	SGE126	SU2302	GE82		SGE517
WR24X5115	SGE110	SGE433	AD79	SAD83	SU2102	GE127	SGE127	SU2302	GE88		SGE517
WR24X5116		SGE433	AM22		SU2002	GE128	SGE301		GE94		SU2302
WR24X5118		SGE422	AM23		SU2004	GE129	SGE303	SU2302	GI30		SU2302
WR24X5119		SGE422	AM28		SU2301	GE130	SGE284		GI33		SU2302
WR24X5123		SGE433	AM29	SAM29	SU2213	GE132	SGE286		GI41		SU2102
WR24X5124		SGE422	AM30		SU2301	GE133	SGE318		GI42		SU2106
WR24X5125		SU2304	AM31		SU2302	GE134	SGE309		GI43	SGI47	SU2102
WR24X5126		SU2302	AM32	SAM32	SU2302	GE135	SGE319	SU2002	GI44	SGI46	SU2102
WR24X5133	SGE312	SU2301	CS25		SU2303	GE136	SGE390		KL34		SU2302
WR24X5134	SGE127	SU2302	CS26		SU2302	GE137	SGE433	SGE433	KL35		SU2302
WR24X5137		SU2301	CS27	SCS27	SU2302	GE138	SGE287		KL36	SKL36	SU2302
WR24X5140		SU2104	CS28		SU2301	GE139	SGE312	SU2301	KL37	SKL37	SU2301
WR24X5141		SU2104	CS29		SU2301	GE140		SU2301	KL56		SU2302
WR24X5144		SU2304	CS31		SU2303	GE141	SGE311	SU2302	KL57		SU2301
WR24X5148	SGE422	SGE422	CS32		SU2213	GE142	SGE422	SGE422	PH47		SU2213
WR24X5149		SGE422	CS33		SU2302	GE143		SGE517	PH48		SU2213
WR24X5150		SU2304	CS34		SU2302	GE144		SGE517	PH49		SU2213
WR24X517		SGE517	CS36		SU2301	GE146		SU2302	PH50		SU2301
WR24X518	SGE485	SGE485	CS37		SU2301	GE147		SU2301	PH52	SPH52	SU2301
WR24X5206		SGE421	CS40		SU2213	GE148		SU2106	PH53	SPH53	SU2302
WR24X5211		SGE433	CS41	SCS79	SU2304	GE151		SGE433	PH54		SU2302
WR24X5212		SGE433	CS42	SCS42	SU2302	GE152			PH55		SU2301
WR24X5215		SU2102	CS43	SCS92	SU2302	GE153	SGE295	SGE432	PH57		SU2302
WR24X5230		SGE433	CS44	SCS44	SU2213	GE155	SGE300	SGE432	WC12	SWC12	
WR24X5231	SGE5231	SGE433	CS46	SCS46	SU2302	GE156	SGE302	SGE433	WE55	SWE55	
WR24X5232	SGE5232	SGE433	CS47	SCS100	SU2302	GE157	SGE305	SGE432	WE58	SWE58	
WR24X5238		SU2102	CS49	SCS49	SU2302	GE158	SGE308	SGE421	WE70		SU2302
WR24X524	SGE524		CS50		SU2303	GE159		SU2106	WE71		SU2213
WR24X5256		SGE432	CS51	SCS98	SU2303	GE160	SGE389	SGE421	WE72		SU2301
WR24X5258		SGE433	CS52	SCS115	SU2303	GE161	SGE421	SGE421	WE73		SU2303
WR24X526		SGE433	CS53		SU2301	GE162	SGE432	SGE432	WP104		SU2301
WR24X5265		SU2304	CS54		SU2302	GE163		SU2102	WP13		SU2301
WR24X527		SGE433	CS55		SU2301	GE164		SGE433	WP16		SU2213
WR24X528	SGE528	SGE433	CS56	SCS116	SU2304	GE165		SGE433	WP16	SCS79	SU2304
WR24X550		SU2203	CS57	SCS102	SU2301	GE166		SGE433	WP17		SU2213
WR24X558	SGE558		CS58	SCS97	SU2304	GE167		SGE433	WP18	SCS92	SU2302

# Refrigerator Door Gasket Cross Reference









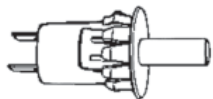
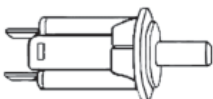
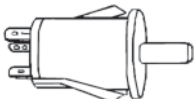

Gemline (Cont.)			Maytag (Cont.)			Whirlpool (Cont.)			Whirlpool (Cont.)		
OEM No.	Supco No.	Universal Kit	OEM No.	Supco No.	Universal Kit	OEM No.	Supco No.	Universal Kit	OEM No.	Supco No.	Universal Kit
WP20		SU2213	66929-9		SU2204	1109187	SCS115	SU2303	2165383		SU2301
WP21	SCS105	SU2304	68543-3	SAD79	SU2003	1109188	SCS75	SU2303	2166000		SU2301
WP28	SCS93	SU2301	68543-4		SU2102	1110568	SCS93	SU2301	2166001		SU2301
WP31		SU2303	69348203		SU2204	1110569	SCS98	SU2303	2177230	SCS92	SU2302
WP32		SU2302	69351298		SU2204	1110648	SCS105	SU2304	2177232	SCS103	SU2302
WP33		SU2301	70025-1		SU2204	1110649	SCS116	SU2304	2177234		SU2302
WP449		SU2302	70025-2	SAD99	SU2002	1110658	SCS79	SU2304	2188404	SCS105	SU2304
WP566	SCS102	SU2301	70025-3		SU2204	1110659	SCS97	SU2304	2188405	SCS79	SU2304
WP567		SU2301	70025-4	SAD97	SU2002	1114800		SU2304	2188406	SCS79	SU2304
WP570	SCS100	SU2302	70025-5	SAD100	SU2001	1114820		SU2304	2191888	SCS112	SU2303
WP572	SCS92	SU2302	70025-6	SAD101	SU2002	1114822		SU2304	2191889		SU2301
WP577	SCS103	SU2302	70047-1	SAD67	SU2101	1114858		SU2304	4339427	SCS102	SU2301
WP589		SU2303	70047-2	SAD69	SU2101	1115314	SCS105	SU2304	4343266		SU2102
WP590	SCS46	SU2302	70047-3	SAD71	SU2102	1115315	SCS79	SU2304	4343267	SCS107	SU2102
WP591		SU2303	70047-4		SU2101	1116582	SCS99	SU2302	4387563		SU2301
WP608	SCS115	SU2303	70048-1	SAD68	SU2102	1116592	SCS100	SU2302	4387564		SU2301
WP609	SCS75	SU2303	70048-2	SAD70	SU2102	1116734	SCS99	SU2302	4387565	SCS93	SU2301
WP617	SCS79	SU2304	70048-3	SAD83	SU2102	1116735	SCS100	SU2302	4387566	SCS102	SU2301
WP622	SCS105	SU2304	70048-4	SAD73	SU2104	1118191	SCS116	SU2304	4387567		SU2302
WP626		SU2104	70048-5	SAD81	SU2102	1118192	SCS97	SU2304	4387568		SU2301
WP634	SCS97	SU2304	D3786409		SU2204	1119565		SU2302	4387570	SCS100	SU2302
WP638	SCS116	SU2304	D7092601Q		SU2213	1119568	SCS92	SU2302	4387572	SCS92	SU2302
WP99	SCS99	SU2302	D7092602Q	SAM29	SU2213	1122826	SCS115	SU2303	4387576		SU2302
			D7092603Q		SU2213	1122827	SCS75	SU2303	4387577	SCS103	SU2302
			D7092608Q	SAM41	SU2213	1122828		SU2302	4387580	SCS103	SU2302
			D7092609Q		SU2213	1122829	SCS102	SU2301	4387583		SU2302
			D7251001Q		SU2301	1122830		SU2302	4387588		SU2302
			D7251002Q		SU2304	1122831	SCS92	SU2302	4387589		SU2302
			D7251004Q		SU2301	1124971	SCS116	SU2304	4387590	SCS46	SU2302
			D7605105Q		SU2102	1124972	SCS97	SU2304	4387591		SU2302
			D7605106Q	SAM43	SU2102	1125147		SU2304	4387592		SU2302
			D7605107Q	SAM44	SU2102	1125886	SCS92	SU2302	4387602	SCS112	SU2303
			D7605108Q	SAM33	SU2102	1125887		SU2302	4387603	SCS99	SU2302
			D7605109Q	SAM34	SU2102	1125888	SCS100	SU2302	4387604	SCS99	SU2302
			D7605110Q	SAM35		1125889	SCS99	SU2302	4387605	SCS99	SU2302
			D7605115Q	SAM39	SU2102	1125924	SCS103	SU2302	4387607	SCS98	SU2303
			D7605116Q	SAM40	SU2102	1125926	SCS79	SU2304	4387608	SCS115	SU2303
			D7825205	SAM62	SU2106	1125927	SCS105	SU2304	4387609	SCS75	SU2303
			D7870905	SAM62	SU2106	1125928	SCS97	SU2304	4387611		SU2303
			D7870905Q	SAM62	SU2106	1125929	SCS116	SU2304	4387617	SCS79	SU2304
						1126756		SU2302	4387622	SCS105	SU2304
						1126762	SCS92	SU2302	4387623	SCS105	SU2304
						1127256	SCS103	SU2302	4387624	SCS105	SU2304
						1127307	SCS116	SU2304	4387626		SU2104
						1127308	SCS97	SU2304	4387627		SU2302
						1127309	SCS116	SU2304	4387628		SU2304
						1127310	SCS97	SU2304	4387630		SU2304
						1128059	SCS115	SU2303	4387632		SU2304
						1128060	SCS102	SU2301	4387634	SCS97	SU2304
						1128061	SCS98	SU2303	4387637	SCS97	SU2304
						1128064	SCS93	SU2301	4387638	SCS116	SU2304
						1128090		SU2304	4387639	SCS116	SU2304
						1128158		SU2304	4387641	SCS116	SU2304
						1129266	SCS105	SU2304	4387655	SCS100	SU2302
						1129267	SCS79	SU2304	481783		SU2213
						2147024	SCS103	SU2302	509361		SU2213
						2148043	SCS115	SU2303	509993		SU2213
						2148044	SCS102	SU2301	510256		SU2213
						2148270	SCS105	SU2304	511312		SU2213
						2148271	SCS79	SU2304	511399		SU2213
						2148565		SU2302	512270		SU2213
						2148567	SCS92	SU2302	512273		SU2213
						2150117	SCS75	SU2303	512274	SCS27	SU2213
						2150124		SU2302	520816		SU2213
						2160436	SCS103	SU2302	520817		SU2213
						2160438	SCS103	SU2302	520818		SU2213
						2160883	SCS103	SU2302	520819	SCS27	SU2213
						2162642	SCS112	SU2303	520820		SU2213

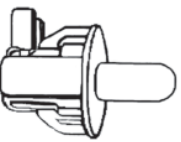
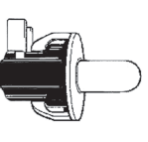
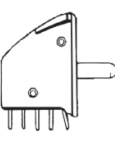
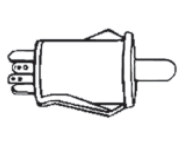

# Refrigerator Door Gasket Cross Reference

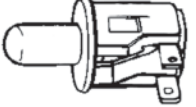
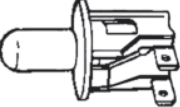
Whirlpool (Cont.)			Whirlpool (Cont.)			Whirlpool (Cont.)		
OEM No.	Supco No.	Universal Kit	OEM No.	Supco No.	Universal Kit	OEM No.	Supco No.	Universal Kit
520821		SU2213	839858		SU2302	986703	SCS92	SU2302
522042		SU2213	845281		SU2303	986704	SU2302	
522048		SU2213	845282		SU2213	986705	SU2302	
522056		SU2213	845283		SU2301	986706	SCS105	SU2304
522057		SU2213	845376		SU2303	986707	SCS116	SU2304
527103		SU2213	848394		SU2213	987036	SCS46	SU2302
527697		SU2213	849336		SU2303	987037	SCS100	SU2302
527698	SCS27	SU2213	849410		SU2303	987151	SCS46	SU2302
527699		SU2213	849462		SU2303	987152	SCS100	SU2302
527713		SU2213	912564		SU2302	987153	SU2302	
528225		SU2213	912565		SU2301	987154	SCS92	SU2302
528917		SU2213	935761	SCS115	SU2303	988497		SU2301
528918		SU2213	937001	SCS102	SU2301	991117		SU2302
530818		SU2213	939048	SCS115	SU2303	991143		SU2302
539898		SU2213	939049	SCS102	SU2301	992487	SCS92	SU2302
539902		SU2304	939341	SCS116	SU2304	992488		SU2104
553789		SU2213	939342	SCS97	SU2304	992582		SU2301
553839	SCS108	SU2213	939565	SCS105	SU2304	992741		SU2301
554478		SU2213	939566	SCS79	SU2304			
556226	SCS108	SU2213	939911		SU2302			
556227		SU2213	940162		SU2304			
556241	SCS108	SU2213	942256		SU2302			
556252		SU2213	942268	SCS115	SU2303			
556253	SCS108	SU2213	942271	SCS102	SU2301			
556256		SU2213	942287	SCS115	SU2303			
556292		SU2213	942289	SCS102	SU2301			
567329		SU2213	942299	SCS46	SU2302			
567897		SU2213	942674		SU2104			
567932		SU2213	942678		SU2302			
576399	SCS108	SU2213	942687		SU2304			
576400	SCS108	SU2213	942903	SCS100	SU2302			
581985	SCS108	SU2213	942931		SU2302			
592950	SCS111	SU2213	942933	SCS92	SU2302			
592951		SU2213	942964		SU2302			
653973		SU2213	943055		SU2302			
654025		SU2213	943057		SU2302			
654027		SU2213	943116	SCS105	SU2304			
654035		SU2301	943117	SCS79	SU2304			
654191		SU2304	943220	SCS105	SU2304			
654264		SU2213	943221	SCS79	SU2304			
654399		SU2213	943623		SU2304			
654470		SU2213	943981		SU2302			
654471		SU2213	943982	SCS92	SU2302			
654472		SU2213	944457	SCS116	SU2304			
655601		SU2304	944470	SCS97	SU2304			
655893		SU2213	944925	SCS98	SU2303			
728686	SCS111	SU2213	944948	SCS93	SU2301			
728688		SU2213	945061	SCS103	SU2302			
730393	SCS111	SU2213	945092		SU2301			
730414		SU2213	945832		SU2302			
730451	SCS111	SU2213	945833	SCS92	SU2302			
753080		SU2213	946802	SCS115	SU2303			
753081		SU2213	946803	SCS102	SU2301			
753440	SCS111	SU2213	946990	SCS115	SU2303			
836109		SU2302	946991	SCS75	SU2303			
836224		SU2302	946992	SCS115	SU2303			
836226		SU2301	946993	SCS75	SU2303			
836227	SCS92	SU2302	946994	SCS102	SU2301			
836228	SCS79	SU2304	946995		SU2302			
836356	SCS46	SU2302	946996	SCS102	SU2301			
836357	SCS100	SU2302	946997		SU2302			
836506		SU2301	9790369	SCS112	SU2303			
836507	SCS100	SU2302	981037		SU2302			
836508	SCS92	SU2302	981038		SU2302			
836509		SU2302	981092		SU2104			
836510	SCS46	SU2302	983644	SCS97	SU2304			
836511		SU2302	986016	SCS103	SU2302			
838141	SCS60	SU2213	986702		SU2302			

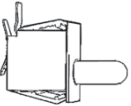
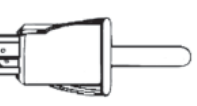
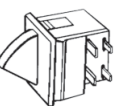
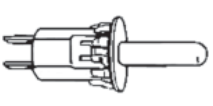
# Switches

<b>ES18100</b> Refrigerator/Freezer	<b>ES18200</b> Refrigerator/Freezer	<b>ES18300</b> Refrigerator/Freezer Fan	<b>ES18500</b> Refrigerator / Freezer Fan & Light	<b>ES18600</b> Refrigerator / Freezer Fan & Light
Easy snap in horizontal mount, with .250 push on terminals	Easy snap in horizontal mount, with .250 push on terminals	Easy snap in horizontal mount	White, Vertical mount 3 Terminal	Momentary contact Push on
Replaces: 18801, 188-1 Amps 1.5 / 4 amps	Replaces: 18200, 182 Amps 10 / 5 amps	Replaces: 18300, 183 Amps .75 / .25 amps	Replaces: 18500, 185 Amps .25 / .75 amps	Replaces:18600, 186 Amps 5 / 2.5 amps
Volts 125 / 250	Volts 125 / 250	Volts 125 / 250	Volts 125 / 250	Volts 125 / 250
Mount Snap in	Mount Snap in	Mount Threaded	Mount Threaded	Mount Snap in
				
<b>ES18700</b> Domestic Commercial	<b>ES18801</b> Domestic Commercial	<b>ES18802</b> Refrigerator/Freezer Light	<b>ES18803</b> Refrigerator/Freezer Fan & Light	<b>ES18804</b> Refrigerator/Freezer Fan & Light
Universal door switch Gibson, Used on commercial walk ins	Color coded Red body fan switch. Used for 30 years	Color coded Black body light switch. Used for 30 years	White, Horizontal mount 4 Terminal, 2 circuit	White, Vertical mount 4 Terminal, 2 circuit
Replaces: 18700, 187	Replaces: 18801, 188-1	Replaces: 18802, 188-2	Replaces: 18803, 188-3	Replaces: 18804, 188-4
Amps .25 / .75 amps	Amps 5 / 2.5 amps	Amps 5 / 2.5 amps	Amps 5 / 2.5 amps	Amps 4 / .75 amps
Volts 125 / 250	Volts 125 / 250	Volts 125 / 250	Volts 125 / 250	Volts 125 / 250
Mount Threaded	Mount Snap in	Mount Snap in	Mount Snap in	Mount Snap in
				
<b>ES18805</b> Refrigerator/Freezer Fan	<b>ES18806</b> Refrigerator/Freezer Light	<b>ES18809</b> Refrigerator/Freezer Fan	<b>ES18810</b> Refrigerator/Freezer Light	<b>ES18811</b> Refrigerator/Freezer Fan & Light
White Rectangular , Easy snap in design	White Rectangular , Easy snap in design	Easy installation	Easy installation	SPDT Heavy Duty Switch, typically used on GE Dishwashers, and others.
Replaces: 18805, 188-5	Replaces: 18806, 188-6	Replaces: 18809, 188-9	Replaces: 18810, 188-10	Replaces: 18811, 188-11
Amps 5 / 2.5 amps	Amps 5 / 2.5 amps	Amps 5 / 2.5 amps	Amps 5 / 2.5 amps	Amps 5 / 2.5 amps
Volts 125 / 250	Volts 125 / 250	Volts 125 / 250	Volts 125 / 250	Volts 125 / 250
Mount Snap in	Mount Snap in	Mount Snap in	Mount Snap in	Mount Snap in
				
<b>ES18812</b> Refrigerator/Freezer Fan & Light	<b>ES18813</b> Refrigerator / Freezer Fan & Light	<b>ES18814</b> Refrigerator / Freezer Fan & Light	<b>ES18815</b> Refrigerator / Freezer Light	<b>ES18817</b> Refrigerator / Freezer Fan
3 Terminals	4 terminal	4 terminal	Longer shaft	Whirlpool 2149705
	Replaces:18813, 188-13 Amps 4 / 1.5 amps	Replaces:18814, 188-14 Amps 5 / 2.5 amps	Replaces:18815, 188-15 Amps 1/2 amps	Replaces:18817, 188-17 Amps 5 / 2.5 amps
Replaces: 18812, 188-12	Volts 125 / 250	Volts 125 / 250	Volts 125 / 250	Volts 125 / 250
Amps 10 amps	Mount Snap in	Mount Snap in	Mount Snap in	Mount Snap in
Volts 125 / 250				
Mount Snap in				
				

# Valves & Fittings



## SUD Series Copper Driers

SUPCO Copper Driers are high quality, high capacity original equipment components for use on both domestic and commercial refrigerators, freezers and air conditioners.

### Features

- 100% XH-9 beaded molecular sieve
- Hermetically sealed
- Copper shells and end tubes
- High capacity
- Easy break off grooved ends

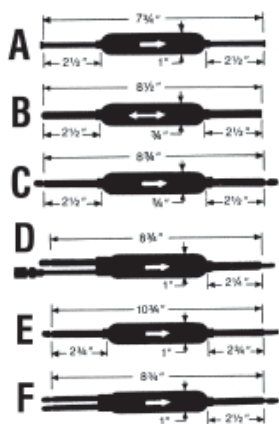

**NOTE:** All driers are compatible with all refrigerants.

PART NO.	DROPS OF WATER REMOVED				RECOMMENDED TONNAGE	
	R-12		R-22		R-12	R-22
	75°	125°	75°	125°		
SUD103	37.5	34	34	32	1/3	1/2
SUD109	37.5	34	34	32	1/3	1/2
SUD110	37.5	34	34	32	1/3	1/2
SUD111	74	68	68	64	3/4	1
SUD112	99	93	95	90	1	2
SUD113	74	68	68	64	3/4	1
SUD114	74	68	68	64	3/4	1
SUD115	37.5	34	34	32	1/3	1/2
SUD116	74	68	68	64	3/4	1

## SUPCO Copper Extended Driers

PART NO.	DESCRIPTION	INLET	OUTLET	DIMENSIONS (SEE CHART)
SUD103	1" Plugged Ends	1/4" O. D.	1/4" O. D.	A
SUD109	3/4" Non-Directional	1/4" O. D.	1/4" O. D.	B
SUD110	3/4" Fused Ends	1/4" O. D.	1/4" O. D.	C
SUD111	1" Charging Drier	1/4" O.D. 1/4" Flare	1/4" O.D. or Cap	D
SUD112	1" Step Down Drier	5/16" O.D.	5/16" O.D. or Cap	E
SUD113	1" Double Inlet	(2)1/4" O. D.	1/4" O. D.	F
SUD114	1" Fused Ends	1/4" I.D. 1/4" O. D.	1/4" O.D. or Cap	G
SUD115	3/4" Charging Drier	1/4" I.D. 1/4" O. D. 1/4" Flare	1/4" O. D. or Cap	H
SUD116	1" Step Down Drier	3/16", 1/4", 5/16" I.D.	5/16" I.D. or Cap	J



## VI2404 3/4" Brass Valve Adapter Icemaker/Humidifier

- 90° construction to relieve stress on tubing
- 3/4" MHT to 1/4" Compression
- Washer included
- Many icemaker valves require a 3/4" MHT connector
- All brass won't rust

## BPV Series Bullet® Piercing Valves

The *ONLY* valve with a permanent type, patented gasket application!

SUPCO's "Bullet® Piercing Valve" utilizes the same type of gasket found under the head plate of most air conditioning compressors. When installed, the gasket actually compresses the copper tubing .020" creating a permanent, leakproof seal that will withstand any pressure and temperature for the life of the unit.

### Features

- Patented valve gasket application provides 50 times more sealing area than competitive "O" ring types
- A sealing force of over 180 inch lbs., torque tested with 500 lbs., pressure tested at 250°F
- Precision piercing needle is engineered for concentricity and hardness to insure perfect seating every time
- Nonpositional mounting — No adapter valve required
- Requires only a 2" clearance area for installation and operation
- Hex key wrench included — No additional tools required
- Corrosion resistant plated and lacquered finish

### Applications

- Install on the high side as a permanent valve on the job
- Install on round suction lines or uneven tubing

BPV SERIES BULLET® PIERCING VALVES		
PART NO.	O.D. TUBING SIZE	PACKAGING
BPV31*	1/4", 5/16", 3/8"	12/Box
BPV31D*	1/4", 5/16", 3/8"	48/Box
BPV21*	1/2", 5/8"	8/Box
BPV36	3/16"	12/Box
BPV14	1/4"	12/Box
BPV56	5/16"	12/Box
BPV38	3/8"	12/Box
BPV12	1/2"	8/Box
BPV58	5/8"	8/Box
BPV34	3/4"	1/Box
BPV78	7/8"	1/Box

\*NOTE: BPV31 and BPV21 are furnished with adapter sleeves for indicated multiple use applications.

# Valves & Fittings

## Line Service Valves

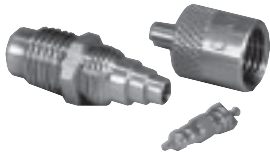

PART NO.	DESCRIPTION	PIPE THREAD	PART NO.	DESCRIPTION	PIPE THREAD
SF1010	1/8" copper tubing, wrench cap and core	—	SF3603	3/16" copper tubing, wrench cap and core	1/8" MIP
SF2525	1/4" copper tubing, wrench cap and core	—	SF3604	1/4" copper tubing, wrench cap and core	1/8" MIP
SF3600	1/8" ID hole, 3/16", 1/4", 5/16" steps, 1/8" MPT below hex wrench cap and core	—	SF3605	5/16" copper tubing, wrench cap and core	—
			SF3606	3/8" copper tubing, wrench cap and core	—
SF3602	1/4" copper tubing, 3/16" & 1/8" copper bushings, wrench cap and core	1/8" MIP	SF3608	1/8" copper tubing, wrench cap and core	1/8" MIP

## SA Series Adjustable Line Tap Valves



### Features

- Available in two sizes to accommodate five different OD tube sizes.
- Depressor valve action
- Can be mounted in any position
- Retracting needle ensures no restriction
- Throw away depressor pin simplifies line piercing
- Hex wrench included
- Adapter sleeves included
- Can be used with all refrigerants including R410A
- Maximum operating pressure 800 PSI
- Sold in 12 packs

### Applications

- Used to provide access fitting without having to remove refrigerant from air conditioning, refrigeration and heat pump systems.

PART NO.	TUBE SIZE OD	REPLACES
SA1	1/4", 5/16", 3/8"	A1 Watsco, A1 Diversitech, QTM1
SA2	1/2", 5/8"	A2 Watsco, A2 Diversitech, QTM2

# Valve Tools

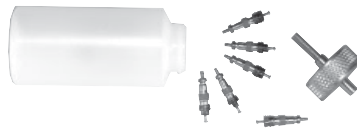

### SF3800 Chaser

- Two tools, a core wrench and thread chaser, complete with a core carrying case and six cores
- Length with core wrench lid 3 1/2"

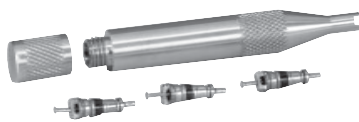

### SF3813 Valve Core Remover / Container

- Heavy-duty, all brass
- Includes 3 valve cores
- Length is 3"



### SF4311 "FasTap" Tube Piercing Pliers

Fast refrigerant recovery with pliers that clamp on and pierce tube. Pliers work on copper tubing sizes ranging from 1/4" to 7/8" OD. They are simple to use and light weight. Adjust pliers to proper size, align tip to the center of tube, clamp down and pierce with quick action. Piercing tip is self-sharpening, but also easily replaceable.



### SF4314 Tube Piercing Pliers Replacement Tip

# Condensate Drain Pans

## 70 Condensate Drain

Authorized, cost effective replacement drain for most commercial refrigerators and freezers.

### Features/Benefits:

- PTC Control supplies only required heat to evaporate water.
- Thermostat and float NOT required
- Self regulating
- Uniform heating

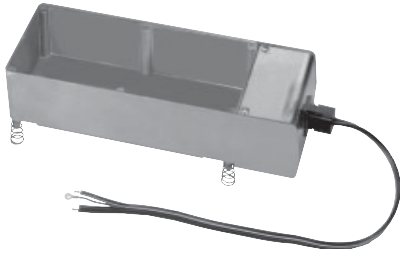

PART NO.	CAPACITY	VOLTS	WATTS	AMPS	EVAPORATE RATE	SIZE
70	50 OZ.	115	300	2.61	6 OZ./HR.	12 1/4" x 4 3/4" x 3"
70-220	50 OZ.	220	300	1.36	6 OZ./HR.	12 1/4" x 4 3/4" x 3"
70CSA*	50 OZ.	115	190	1.65	6 OZ./HR.	12 1/4" x 4 3/4" x 3"
70CSA220*	50 OZ.	220	190	.86	6 OZ./HR.	12 1/4" x 4 3/4" x 3"

\*CSA indicates CSA approval. \*\* All are 50/60 HZ

## 30-OS, 31 & 75 Condensate Drains

- Standard cast aluminum condensate drains complete with long life heating element and mounting legs.
- Designed for continuous use.



PART NO.	CAPACITY	VOLTS	WATTS	AMPS	EVAPORATE RATE	SIZE
30-OS*	38 OZ.	120	160	1.33	8 OZ./HR.	10" x 4" x 2 7/8"
30-220-OS*	38 OZ.	220	160	.73	8 OZ./HR.	10" x 4" x 2 7/8"
31	50 OZ.	120	160	1.33	6 OZ./HR.	10" x 4 1/2" x 3 3/8"
31-220	50 OZ.	220	160	.73	6 OZ./HR.	10" x 4 1/2" x 3 3/8"
75	75 OZ.	120	320	2.67	14 OZ./HR.	10" x 9" x 2 3/4"
75-220	75 OZ.	220	320	1.45	14 OZ./HR.	10" x 9" x 2 3/4"

\* Indicates NSF listing \*\* All are 50/60 HZ

## Wall Mount Brackets

PART NO.	CONDENSATE DRAIN NO.
30WM	30-OS Series, 70 Series
31WM	31 Series

# Defrost Heaters

## SH200 Series Flexible Braided Aluminum Drain Heat

Designed for continuous use to protect drains from ice build up. Heaters are offered in a variety of lengths and wattages.

### Applications

- Domestic and Commercial Refrigeration
- Air Conditioning and Heat Pump Systems
- Condensate Drain Pans, Tubes, and Troughs

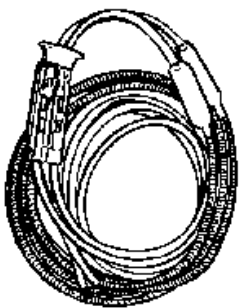

Supco Part No.	Watts	Volts	Heated Length	Leads	Mars No.	Gemline No.
SH201	15	115	18"	23"	34121	GH201
SH202	45	115	29"	23"	34122	GH202
SH203	55	115	44"	23"	34123	GH204
SH204	75	115	48"	23"	34124	GH203
SH205	65	115	56"	23"	34125	GH205
SH206	80	115	70"	23"	34126	GH206
SH207	110	115	86"	23"	34127	GH207

# Defrost Heaters



## SH220 Series Aluminum Foil Heaters

### Features and Benefits

- Pressure Sensitive Adhesive Backing
- Assorted Shapes
- Assorted Wattages

### Applications

- Domestic and Commercial Refrigeration
- Drain Pans
- Drain Troughs
- Mullions
- Spot Heating

Supco Part No.	Watts	Volts	Size	Mars No.	Gemline No.
SH221	6	115	10" X 1"	34111	GH221
SH222	10	115	24" X 1 1/4'	34112	GH222
SH223	10	115	14 1/2" X 5 1/2"	34113	GH223
SH224	65	115	27 1/2" X 5 1/2"	34114	GH224
SH225	15	115	10 1/2" X 10 1/2"	34115	GH225
SH226	40	115	10 1/2" X 10 1/2"	34116	GH226



## SH251 Universal Silicone Drain Heater

A 7 1/2" silicone tip drain heater designed to fit in the drain opening. The SH251 is wired in series only, applying low wattage heat when the drain heater or defrost heater is on. Rated at 8 watts to be wired in series in a 110 to 120 volt circuit. Replaces GE WR51X72, Electrolux 6582706, and Mars 34171.



## SH280 Series Mullion and Dewpoint Door Heaters

### Features and Benefits

- Prevents Moisture on Glass Display Doors
- Eliminates Moisture and Frost Build Up On Doors and Cabinet Fronts

### Applications

- Domestic and Commercial Refrigeration
- Drain Pans and Troughs
- Mullions
- Spot Heating

Supco Part No.	Watts	Volts	Size	Gemline No.
SH281	6	115	10" X 1"	GH281
SH282	10	115	24" X 1 1/4'	GH282
SH283	10	115	14 1/2" X 5 1/2"	GH283
SH284	65	115	27 1/2" X 5 1/2"	GH284



## SH500 Series Drain Heaters

Designed for continuous use to protect drains from ice build up. Heaters are offered in a variety of lengths, voltages, and wattages.













### Applications

- Domestic and Commercial Refrigeration
- Air Conditioning and Heat Pump Systems
- Condensate Drain Pans, Tubes, and Troughs
- 120V and 240 V heaters

Supco Part No.	Watts	Volts	Heated Length	Leads
SH500	11	120	9"	18"
SH502	15	120	13"	18"
SH503	15	240	13"	18"
SH504	25	120	21"	18"
SH505	25	240	21"	18"

# Defrost Heaters





## Universal Replacement Glass Defrost Heaters

SH261	SH263	SH264	SH265
			
550 Watts      115 Volts Glass Length    21 3/16" Overall Length   21 15/16"	630 Watts      115 Volts Glass Length    21 5/8" Overall Length   22 3/8"	550 Watts      115 Volts Glass Length    8 1/2" Overall Length   9 1/4"	625 Watts      115 Volts Glass Length    10 5/8" Overall Length   11 3/8"
Single Tube GE Style Supports incld.	Single Tube GE Style Supports incld.	Two Series Tubes GE Style Supports incld.	Two Series Tubes
SH266	SH267	SH270	SH271
			
525 Watts      115 Volts Glass Length    21 5/8" Overall Length   22 9/16"	500 Watts      115 Volts Glass Length    22 13/16" Overall Length   23 13/16"	550 Watts      115 Volts Glass Length    24 1/4" Overall Length   25"	600 Watts      115 Volts Glass Length    8" Overall Length   8 3/4"
Single Tube	Single Tube	Single Tube	Two Series Tubes GE Style Supports incld.
SH273	SH274	SH276	SH277
			
775 Watts      115 Volts Glass Length    8" Overall Length   8 3/4"	480 Watts      115 Volts Glass Length    9" Overall Length   9 3/4"	550 Watts      115 Volts Glass Length    10 5/8" Overall Length   11 3/8"	440 Watts      115 Volts Glass Length    22 7/8" Overall Length   23 5/8"
Three Series Tubes GE Style Supports incld.	Two Series Tubes	Two Series Tubes GE Style Supports incld.	Single Tube

# Defrost Heaters





## Exact Replacement Defrost Heaters

### Electrolux



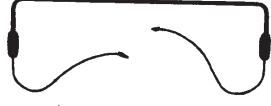

5309956756 SH278	5300158066 SH445	5303001362 SH419	5308009754 SH457
Glass / Vycor / Quartz 	Stainless Steel / Incoloy 	Stainless Steel / Incoloy 	Stainless Steel / Incoloy 
530 Watts Glass Length 20 1/2" Overall Length 22 1/2"	500 Watts Dimensions 23" X 5 1/2"	425 Watts Dimensions 20 1/4" X 3 1/8"	400 Watts Dimensions 20 1/4" X 3 1/8"

### Electrolux

### General Electric

5317842502 SH439	6490-099-1K SH415	WR49X390 SH305	WR49X391 SH303
Stainless Steel / Incoloy 	Stainless Steel / Incoloy 	3 tubes use old bracket 	Glass / Vycor / Quartz 
475 Watts Dimensions 22 3/4" X 5 1/2"	440 Watts Dimensions 20 1/4" X 6 1/8"	785 Watts Glass Length 8 1/4" Groove Width 7 11/16" Overall Length 9 5/8" Reference: WR49X5086	615 Watts Overall Length 9 3/4" 2 tubes brackets included Reference: WR49X249

### General Electric

WR49X392 SH306	WR51X133 SH302	WR51X411 SH307	WR51X412 SH301
Glass / Vycor / Quartz 	Glass / Vycor / Quartz 	use old bracket 	Glass / Vycor / Quartz 
775 Watts Overall Length 12 1/2" 2 tubes brackets included Reference: WR49X250	620 Watts Glass Length 21 7/8" Overall Length 22 5/8"	425 Watts Glass Length 22 1/8" Groove Width 21 1/2" Overall Length 23 7/16" Reference: WR49X194	525 Watts Glass Length 21 3/16" Groove Width 20 5/8" Overall Length 22 5/8" Reference: WR49X169





Part numbers and illustrations are intended solely for identification. Items offered for sale are not represented to be manufactured by the company that built the original model.







# Defrost Heaters

## Exact Replacement Defrost Heaters



### General Electric

WR51X413 SH308	WR51X442 SH309	WR51X443 SH310	WR51X464 SH464
Glass / Vycor / Quartz	Glass / Vycor / Quartz	Glass / Vycor / Quartz	Stainless Steel / Incoloy
			
450 Watts Glass Length 13 7/16" Overall Length 15 1/4"	600 Watts Overall Length 9 1/2" 2 tubes brackets included	772 Watts Overall Length 12 13/16" 2 tubes brackets included	400 Watts Dimensions 21 1/2" X 4"
			Reference: WR51X367

### Maytag

52763-9 SH277	60106-34 SH319	60106-35 SH320	60106-36 SH326
Glass / Vycor / Quartz	Glass / Vycor / Quartz	Glass / Vycor / Quartz	Glass / Vycor / Quartz
			
440 Watts Glass Length 22 7/8" Overall Length 23 5/8"	400 Watts Glass Length 17 1/4" Overall Length 18 "	450 Watts Glass Length 19 5/8" Overall Length 20 7/16"	450 Watts Glass Length 21 1/4" Overall Length 22"
Reference: 52763-7	Reference: 60106-19	Reference: 60106-14	For 1200029 Kit order SH326 & SL8528









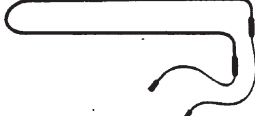

### Maytag

61001846 SH311	61001874 SH374	12001027 SH327 Kit	D7549703 SH437
Glass / Vycor / Quartz	Glass / Vycor / Quartz	Glass Heater with T'Stat	Stainless Steel / Incoloy
			
685 Watts Overall Length 15 1/4"	620 Watts Overall Length 12"	400 Watts Glass Length 17 1/4" Overall Length 18"	500 Watts
Two Series Tubes Reference: 52764-14	Two Series Tubes Reference: 52764-15	12001027 Kit includes heater & SL8528	Dimensions 24 3/4" X 4" Reference: D7549701

Part numbers and illustrations are intended solely for identification. Items offered for sale are not represented to be manufactured by the company that built the original model.

# Defrost Heaters

## Exact Replacement Defrost Heaters

Maytag		Whirlpool	
<b>R0157335</b> <b>SH416</b> Icemaker Mold Heater  165 Watts      120 Volts Dimensions 10" X 2 3/4" Reference: 625843, 625893	<b>1105164</b> <b>SH447</b> Stainless Steel / Incoloy  425 Watts      120 Volts Dimensions 20 7/8" x 5" Reference: 942870	<b>549433</b> <b>SH433</b> Stainless Steel / Incoloy  650 Watts      120 Volts Dimensions 15 3/8" x 7 5/8" Reference: 9344452	<b>851363</b> <b>SH442</b> Stainless Steel / Incoloy  775 Watts      120 Volts Dimensions 18 5/8" x 9 5/16" Reference: 989607
Whirlpool			
<b>851631</b> <b>SH443</b> Stainless Steel / Incoloy  515 Watts      120 Volts Dimensions 23 5/8" X 5 3/4" Reference: 989590	<b>851789</b> <b>SH434</b> Stainless Steel / Incoloy  650 Watts      120 Volts Dimensions 25 5/8" X 7 1/4" Reference: 989612	<b>935798</b> <b>SH432</b> Stainless Steel / Incoloy  475 Watts      120 Volts Dimensions 22" X 6 1/2" Reference: 9344452	<b>936129</b> <b>SH448</b> Stainless Steel / Incoloy  625 Watts      120 Volts Dimensions 24 7/8" X 7 5/8" Reference: 851778
Whirlpool			
<b>937302</b> <b>SH431</b> Stainless Steel / Incoloy  600 Watts      120 Volts Dimensions 23" X 7 3/4" Reference: 9344452	<b>978331</b> <b>SH413</b> Stainless Steel / Incoloy  650 Watts      120 Volts Dimensions 23 5/8" X 6 1/2" Reference: 549393	<b>978945</b> <b>SH414</b> Stainless Steel / Incoloy  650 Watts      120 Volts Dimensions 26 5/8" X 6 1/4" Reference: 549392	<b>978495</b> <b>SH429</b> Stainless Steel / Incoloy  500 Watts      120 Volts Dimensions 25 1/4" X 3 1/4" Reference: 548029

Part numbers and illustrations are intended solely for identification. Items offered for sale are not represented to be manufactured by the company that built the original model.

# Heaters Cross Reference

Electrolux			Gemline (Cont.)			General Electric (Cont.)			Mars			Maytag (Cont.)			Maytag (Cont.)		
OEM No.	Supco No.		OEM No.	Supco No.		OEM No.	Supco No.		OEM No.	Supco No.		OEM No.	Supco No.		OEM No.	Supco No.	
08000061	SH439	D	GH272	SH272	U	WR51X188	SH303	D	34151	SH261	U	52763-9	SH267	U	61002046	SH267	U
08000745	SH419	D	GH273	SH273	U	WR51X188	SH271	U	34152	SH262	U	52764-1	SH311	D	625843	SH416	D
08004171	SH419	D	GH274	SH274	U	WR51X192	SH306		34153	SH263	U	52764-1	SH264	U	628943	SH416	D
08009564	SH439	D	GH275	SH275	U	WR51X192	SH276	U	34154	SH264	U	52764-14	SH311	D	67679-1	SH311	D
08009754	SH457	D	GH276	SH276	U	WR51X194	SH307	D	34155	SH265	U	52764-14	SH264	U	67679-1	SH264	U
28-08-00200-001	SH270	U	GH277	SH277	D	WR51X202	SH303	D	34156	SH266	U	52764-15	SH374	D	67679-2	SH374	D
28-08-00200-004	SH271	U	GH277	SH267	U	WR51X202	SH271	U	34157	SH267	U	52764-15	SH265	U	69848-1	SH311	D
3001362	SH419	D	GH278	SH278	D	WR51X231	SH303	D	34158	SH268	U	52764-18	SH265	U	69848-1	SH264	U
3001466	SH439	D	GH301	SH301	D	WR51X231	SH271	U	34159	SH269	U	52764-22	SH311	D	69848-11	SH311	D
3001529	SH457	D	GH302	SH302	D	WR51X258	SH306	D	34160	SH270	U	52764-22	SH264	U	69848-11	SH264	U
5300158066	SH445	D	GH303	SH303	D	WR51X258	SH276	U	34161	SH271	U	52764-2	SH265	U	69848-12	SH374	D
5303001362	SH419	D	GH304	SH304	D	WR51X319	SH464	D	34162	SH272	U	52764-3	SH268	U	69848-12	SH374	D
5308009754	SH457	D	GH305	SH305	D	WR51X342	SH309	D	34163	SH273	U	52764-4	SH269	U	69848-2	SH374	D
5309956756	SH278	D	GH306	SH306		WR51X343	SH309	D	34164	SH274	U	52764-5	SH265	U	77284-2	SH261	U
5317842502	SH439	D	GH307	SH307	D	WR51X344	SH310	D	34166	SH276	U	52764-6	SH311	D	77284-2	SH261	U
53839	SH439	D	GH319	SH319	D	WR51X345	SH310	D	34175	SH415	D	52764-6	SH264	U	77284-3	SH277	D
623288	SH274	U	GH320	SH320	D	WR51X349	SH309	D	34177	SH419	D	52764-64	SH311	D	77284-3	SH267	U
623528	SH275	U	GH413	SH413	D	WR51X350	SH309	D	34179	SH429	D	52764-64	SH264	U	D7549701	SH437	D
625331	SH264	U	GH414	SH414	D	WR51X365	SH365	D	34181	SH413	D	52764-8	SH311	D	D7549703	SH437	D
6490-084-02	SH270	U	GH415	SH415	D	WR51X367	SH464	D	34182	SH414	D	52764-8	SH264	U	R0157335	SH416	D
6490-084-04	SH266	U	GH419	SH419	D	WR51X371	SH309	D	34188	SH303	D	52764-9	SH265	U	RA95043-1	SH311	D
6490-084-06	SH267	U	GH429	SH429	D	WR51X372	SH310	D	34189	SH305	D	52784-2	SH265	U	RA95043-1	SH264	U
6490-084-08	SH261	U	General Electric			WR51X404	SH309	D	34190	SH306		60106-1	SH319	D	Whirlpool		
6490-084-09	SH267	U	OEM No.	Supco No.	WR51X411	SH307	D	34191	SH307	D	60106-13	SH319	D	OEM No.	Supco No.		
6490-099-1K	SH415	D	WR49X207	SH303	D	WR51X412	SH301	D	34194	SH319	D	60106-14	SH320	D	548029	SH429	D
6599346	SH274	U	WR49X20	SH271	U	WR51X412	SH261	U	34195	SH320	D	60106-15	SH326	D	548030	SH429	D
6599348	SH275	U	WR49X20	SH304	D	WR51X413	SH308	D	34196	SH278	D	60106-17	SH320	D	548635	SH414	D
7546737	SH266	U	WR49X23	SH303	D	WR51X425	SH464	D	34197	SH301	D	60106-19	SH319	D	548645	SH413	D
86486	SH419	D	WR49X23	SH271	U	WR51X430	SH464	D	34198	SH302	D	60106-2	SH320	D	549392	SH414	D
86586	SH457	D	WR49X24	SH303	D	WR51X442	SH309	D	34199	SH304	D	60106-20	SH320	D	549393	SH413	D
9956756	SH278	D	WR49X243	SH271	U	WR51X443	SH310	D	Maytag			60106-21	SH326	D	549418	SH433	D
G000158066	SH445	D	WR49X249	SH303	D	WR51X447	SH464	D	OEM No.	Supco No	60106-23	SH320	D	549433	SH433	D	
G158056	SH445	D	WR49X24	SH271	U	WR51X461	SH310	D	0054628	SH416	D	60106-25	SH319	D	625963	SH416	D
G158066	SH445	D	WR49X25	SH306	D	WR51X463	SH309	D	12001027	SH327	D	60106-26	SH320	D	850535	SH433	D
G162431	SH439	D	WR49X25	SH276	U	WR51X464	SH464	D	29815-1	SH311	D	60106-27	SH326	D	851363	SH442	D
G162431-01	SH439	D	WR49X390	SH305	D	WR51X5002	SH272	U	29815-1	SH264	U	60106-28	SH319	D	851631	SH443	D
G162431-02	SH439	D	WR49X390	SH273	U	WR51X5003	SH272	U	43218	SH416	D	60106-29	SH320	D	851778	SH448	D
G162432-01	SH419	D	WR49X391	SH303	D	WR51X5018	SH305	D	52353-1	SH267	U	60106-3	SH326	D	851789	SH434	D
G162432-02	SH419	D	WR49X391	SH271	U	WR51X5018	SH273	U	52530-1	SH311	D	60106-30	SH326	D	934445	SH433	D
G176807-01	SH457	D	WR49X392	SH306	D	WR51X5024	SH261	U	52530-1	SH264	U	60106-32	SH320	D	935798	SH432	D
G178425-01	SH439	D	WR49X392	SH276	U	WR51X5036	SH261	U	52530-2	SH265	U	60106-34	SH319	D	936129	SH448	D
G178425-02	SH439	D	WR49X5086	SH305	D	WR51X5144	SH305	D	52530-2	SH265	U	60106-35	SH320	D	937302	SH431	D
Gemline			WR49X5086	SH273	U	WR51X5144	SH273	U	52530-6	SH311	D	60106-36	SH326	D	942870	SH447	D
OEM No.	Supco No.	WR49X5088	SH306	D	WR51X5145	SH305	D	52530-6	SH264	U	60106-38	SH320	D	978331	SH413	D	
GH261	SH261	U	WR49X5088	SH276	U	WR51X5145	SH273	U	52763-1	SH277	D	60106-40	SH320	D	978332	SH414	D
GH262	SH262	U	WR49X5106	SH306	D	WR51X5150	SH305	D	52763-1	SH267	U	60106-41	SH320	D	978495	SH429	D
GH263	SH263	U	WR49X5106	SH276	U	WR51X5150	SH273	U	52763-10	SH261	U	60106-44	SH320	D	989590	SH443	D
GH264	SH264	U	WR51X10002	SH464	D	WR51X5167	SH306	D	52763-16	SH261	U	61001139	SH311	D	989607	SH442	D
GH265	SH265	U	WR51X107	SH261	U	WR51X5167	SH276	U	52763-17	SH267	U	61001139	SH264	U	989612	SH434	D
GH266	SH266	U	WR51X133	SH302	D	WR51X5172	SH306	D	52763-3	SH267	U	61001140	SH374	D	989698	SH429	D
GH267	SH267	U	WR51X133	SH263	U	WR51X5172	SH276	U	52763-5	SH261	U	61001846	SH311	D			
GH268	SH268	U	WR51X152	SH262	U				52763-7	SH277	D	61001846	SH264	U			
GH269	SH269	U	WR51X169	SH301	D				52763-7	SH267	U	61001874	SH374	D			
GH270	SH270	U	WR51X183	SH303	D				52763-8	SH261	U	61002045	SH261	U			
GH271	SH271	U	WR51X183	SH271	U				52763-9	SH277	D	61002046	SH277	D			

# Defrost Thermostats



SL45

## ML and SL Series Defrost Thermostats

Metal case with water proof epoxy potting  
 Heavy Duty Rating 10 Amps @ 120 Volts / 5 Amps @ 240 Volts  
 Common Temperature Ranges  
 Typically used for Residential and Commercial Applications  
 Switching is SPST and can accommodate up to 1200 Watts.

Supco No. 12" Leads	Supco No. 24" Leads	Open °F	Close °F	Diff. °F	Mars	Uniline	
	ML37	37	47	10	...	...	...
SL45	ML45	45	25	20	33008	31-001	17001
SL50	ML50	50	30	20	33009	31-002	17003
SL55	ML55	55	35	20	33010	31-003	17005
SL60	ML60	60	40	20	33011	31-004	17007
SL70	ML70	70	50	20	33012	31-005	17009
SL80	ML80	80	30	50	33020	31-006	17011
SL90	ML90	90	35	55	33021	31-007	17013



SL243

## Mounting Clips

Supco No.	Style
SL243	Surface / Flush Mounting Clip
SL245	Push In Mounting Clip
SL247	5/16" or 3/8" Around Tube Clip
SL249	Side Push on Tube Clip
SL250	Kit one of each style



SL245



SL247



SL249

## SLT Series Residential and Commercial Defrost Thermostats

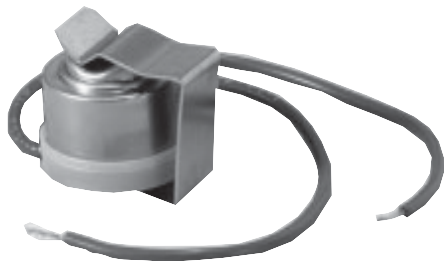

SLT45

Metal case with water proof epoxy potting  
 Heavy Duty Rating 10 Amps @ 120 Volts / 5 Amps @ 240 Volts  
 Typically used for Residential and Commercial Applications  
 Switching is SPST and can accommodate up to 1200 Watts.  
 Tube mounting clip attached to thermostat.  
 Common Temperatures for tube mount applications.  
 Direct Replacement for many commercial applications.

Supco No.	Open °F	Close °F	Diff. °F
SLT45	22	45	23
SLT50	10	50	40
SLT55	25	55	30
SLT60	30	60	30