

MARS[®] 780

DEFINITE PURPOSE CONTACTORS

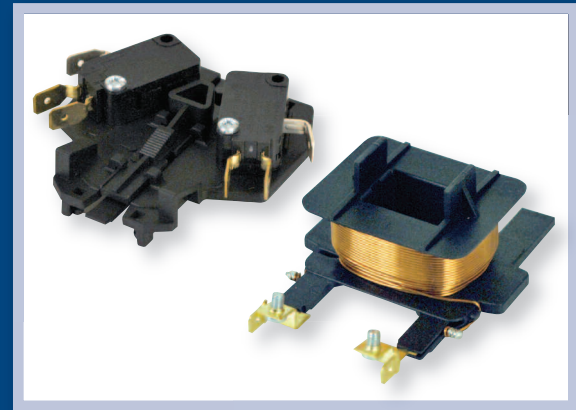

MARS 780 Definite Purpose Contactors Feature the Following:

- **Designed for the most demanding applications**
 - HVAC
 - Refrigeration
 - Food Equipment
 - Industrial
 - Lighting
 - Welding Equipment
- **Meets the following standards-**
 - cULus
 - ARI 780 & 790
 - CE
 - Canadian Heater Rated
 - SCCR 600 VAC
- **Large Arch Window Box Lugs**
- **Compact Enclosed Body Design**
- **Push to Test Button On All Models Except 75 and 90 Amp Contactors**
- **Screw Attached Contact Cover On All Models**
- **Replacement Coils For 3 Pole Contactors**
- **Auxiliary Switches and Interlocks**
- **Silver-Cadmium Oxide Contacts**

MARS 780 Definite Purpose Contactors

MARS SERIES **614**



MARS 780 Definite Purpose Contactors

MARS 780 - 1 pole with shunt contactors are designed for demanding applications. The enclosed body design provides quiet operation and improved durability by reducing the intrusion of dust and dirt. Silver-cadmium oxide contacts provide increased contact life when switching inductive loads.

Features:

- Enclosed body and coil – standard cover
- Push to test button
- Quad quick connects
- Box lugs - large window arch design
- Screw terminals and or box lugs available on 30 amp
- Coils - class F insulation

1 Pole with Shunt 30 - 40 Amps

MARS No.	Furnas No.	FLA	Locked Rotor Amps		Non Inductive Amps	Coil Volts	Termination
			240V	277V			
61320	45EG10AJA, 45CG10AJA, 45DG10AJA	30	180	180	40	24	Screw Type
61321	45EG10AFA, 45CG10AFA, 45DG10AFA					120	
61322	45EG10AGA, 45CG10AGA, 45DG10AGA					208-240	
61323	45EG10ALA, 45CG10ALA, 45DG10ALA					277	
61324	45EG10AHA, 45CG10AHA, 45DG10AHA					480	
61720	45EG10AJAL	30	180	180	40	24	Box Lug
61721	45EG10AFAL					120	
61722	45EG10AGAL					208-240	
61723	45EG10ALAL					277	
61724	45EG10AHAL					480	
61730	45GG10AJAL, 45FG10AJA, 45GG10AJA	40	240	240	50	24	Box Lug
61731	45GG10AFAL, 45FG10AFA, 45GG10AFA					120	
61732	45GG10AGAL, 45FG10AGA, 45GG10AGA					208-240	
61733	45GG10ALAL, 45FG10ALA, 45GG10ALA					277	
61734	45GG10AHAL, 45FG10AHA, 45GG10AHA					480	

MARS 780 Definite Purpose Contactors

MARS SERIES **614**



MARS 780 Definite Purpose Contactors

MARS 780 - 2 pole contactors are designed for demanding applications. The enclosed body design provides quiet operation and improved durability by reducing the intrusion of dust and dirt. Silver-cadmium oxide contacts provide increased contact life when switching inductive loads.

Features:

- Enclosed body and coil – standard cover
- Push to test button
- Quad quick connects
- Box lugs - large window arch design
- Screw terminals and or box lugs available on 30 amp
- Coils - class F insulation

2 Pole 30 - 40 Amps

MARS No.	Furnas No.	FLA	Locked Rotor Amps			Non Inductive Amps	Coil Volts	Termination
			240V	480V	600V			
61345	45EG20AJ, 45CG20AJ, 45DG20AJ	30	180	150	120	40	24	Screw Type
61346	45EG20AF, 45CG20AF, 45DG20AF						120	
61347	45EG20AG, 45CG20AG, 45DG20AG						208-240	
61348	45EG20AL, 45CG20AL, 45DG20AL						277	
61349	45EG20AH, 45CG20AH, 45DG20AH						480	
61745	45EG20AJL	30	180	150	120	40	24	Box Lug
61746	45EG20AFL						120	
61747	45EG20AGL						208-240	
61748	45EG20ALL						277	
61749	45EG20AHL						480	
61755	45GG20AJL, 45FG20AJ, 45GG20AJ	40	240	200	160	50	24	Box Lug
61756	45GG20AFL, 45FG20AF, 45GG20AF						120	
61757	45GG20AGL, 45FG20AG, 45GG20AG						208-240	
61758	45GG20ALL, 45FG20AL, 45GG20AL						277	
61759	45GG20AHL, 45FG20AH, 45GG20AH						480	

MARS 780 Definite Purpose Contactors

MARS SERIES **614**

MARS 780 Definite Purpose Contactors

MARS 780 - 2 pole "Large Body" contactors feature a 2 pole configuration in a 3 pole body for increased durability in demanding applications.

Features:

- Large arch window box lugs
- Recessed push to test button
- Accepts MARS 780 and Furnas auxiliary switches
- Use standard MARS 780 replacement coils
- Dual QC coil terminals plus screw terminal for easy termination and jumper arrangements
- Coils - class F insulation



2 Pole - Large Body 30 - 40 Amp

MARS No.	Furnas No.	FLA	Locked Rotor Amps			Non Inductive Amps	Coil Volts	Horsepower		Termination
			240V	480V	600V			1 PH	3 PH	
								240V	240V	
61425	42BF15AJ, 42AF15AJ	30	180	150	120	40	24	3 HP	7.5 HP	Box Lug
61426	42BF15AF, 42AF15AF						120			
61427	42BF15AG, 42AF15AG						208-240			
61428	42BF15AL, 42AF15AL						277			
61440	42CF15AJ	40	240	200	160	50	24	5 HP	10 HP	Box Lug
61441	42CF15AF						120			
61442	42CF15AG						208-240			
61443	42CF15AL						277			

MARS 780 Definite Purpose Contactors

MARS SERIES **614**

MARS 780 - 3 Pole Contactors



MARS 780 - 3 pole contactors are designed for demanding applications. The enclosed body design provides quiet operation and improved durability by reducing the intrusion of dust and dirt. Side attachment rails for auxiliary switches (30-60 amp contactors) allow attachment of MARS 780 or Furnas auxiliary switches. Silver-cadmium oxide contacts provide increased contact life when switching inductive loads.

Features:

- Large arch window box lugs
- SEMS screws or box lugs available on 30 amp contactors
- Recessed push to test button (not on 75 and 90 amp contactors)
- Enclosed body design
- Accepts MARS 780 and Furnas auxiliary switches
- Use standard MARS 780 replacement coils
- Dual QC coil terminals plus screw terminal for easy termination and jumper arrangements
- Coils - class F insulation • 600 volt rating • Foot print compatible

3 Pole 30 - 90 Amp

* For 25 Amp Contactors - Use 30 Amp in Place of 25Amp

MARS No.	Furnas No.	FLA	Locked Rotor Amps			Non Inductive Amps	Coil Volts	Horsepower				Termination
			240V	480V	600V			1 PH	3 PH			
								240V	240V	480V	600V	
61430*	42BF35AJ	30	180	150	120	40	24	3 HP	7.5 HP	10 HP	15 HP	Screw Type
61431*	42BF35AF						120					
61432*	42BF35AG						208-240					
61433*	42BF35AL						277					
61434*	42BF35AH						480					
61750	-	30	180	150	120	40	24	3 HP	7.5 HP	10 HP	15 HP	Box Lug
61751	-						120					
61752	-						208-240					
61753	-						277					
61754	-						480					
61445	42CF35AJ	40	240	200	160	50	24	5 HP	10 HP	15 HP	20 HP	Box Lug
61446	42CF35AF						120					
61447	42CF35AG						208-240					
61448	42CF35AL						277					
61449	42CF35AH						480					
61460	42DF35AJ	50	300	250	200	63	24	5 HP	15 HP	20 HP	25 HP	Box Lug
61461	42DF35AF						120					
61462	42DF35AG						208-240					
61463	42DF35AL						277					
61464	42DF35AH						480					
61470	42EF35AJ	60	360	300	240	75	24	7.5 HP	20 HP	25 HP	30 HP	Box Lug
61471	42EF35AF						120					
61472	42EF35AG						208-240					
61473	42EF35AL						277					
61474	42EF35AH						480					
61480	42FE35AJ106	75	450	375	300	94	24	15 HP	25 HP	40 HP	40 HP	Box Lug
61481	42FE35AF106						120					
61482	42FE35AG106						208-240					
61483	42FE35AL106						277					
61484	42FE35AH106						480					
61490	42GE35AJ106	90	540	450	360	120	24	15 HP	30 HP	50 HP	50 HP	Box Lug
61491	42GE35AF106						120					
61492	42GE35AG106						208-240					
61493	42GE35AL106						277					
61494	42GE35AH106						480					

MARS 780 Definite Purpose Contactors

MARS SERIES **614**

30-40A 1 Pole with Shunt

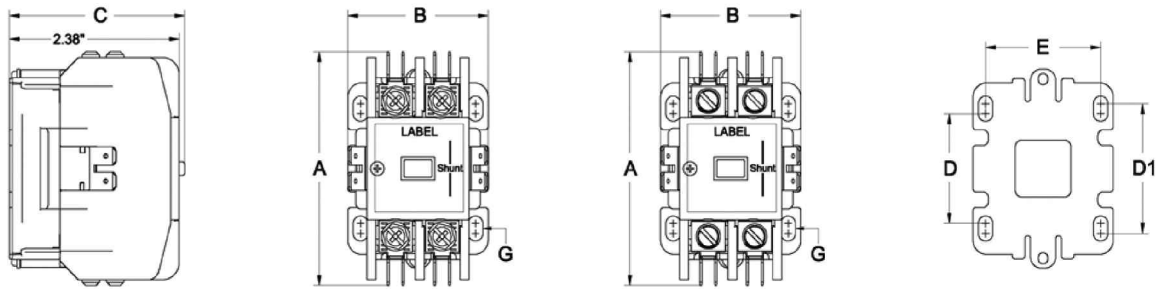

30-40A 2 Pole

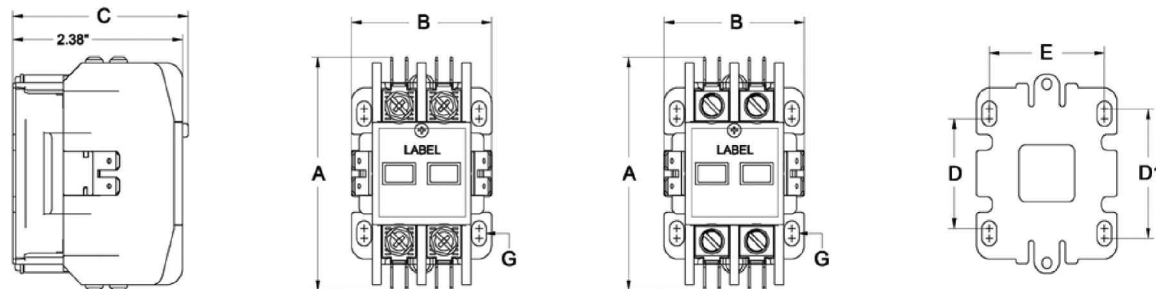

30-40A 2* Pole & 3 Pole

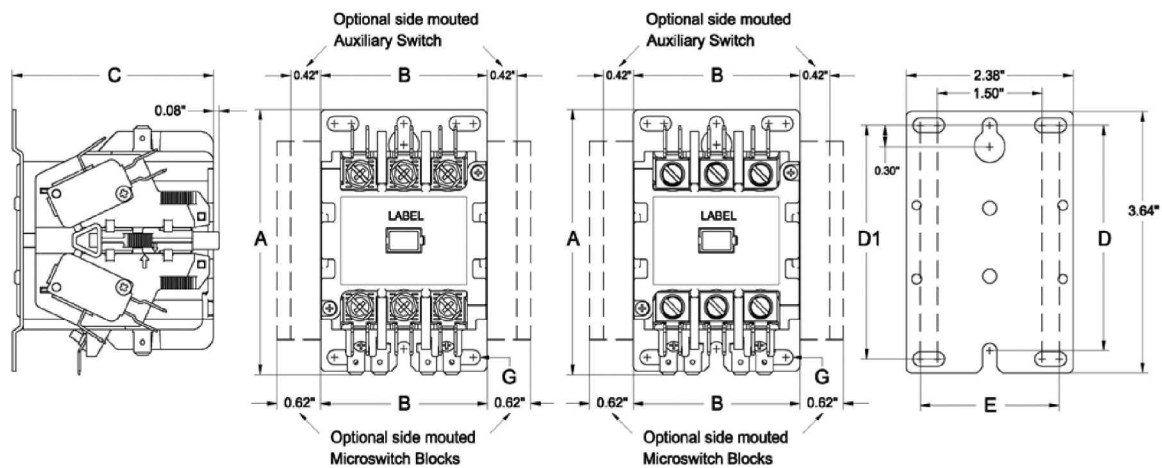

Note - 2* Pole is a 3 pole body with center contacts removed.

MARS No.	FLA	Poles	A	B	C	D	D1	E	Mtg Screw G	Max Wire Size
61320-61324	30	1	3.19	1.97	2.46	1.5	1.77	1.61	10	8
61720-61724 61730-61734	30-40	1	3.19	1.97	2.46	1.5	1.77	1.61	10	4
61345-61349	30	2	3.19	1.97	2.46	1.5	1.77	1.61	10	8
61745-61749 61755-61759	30-40	2	3.19	1.97	2.46	1.5	1.77	1.61	10	4
61430-61434	30	3	3.69	2.38	2.87	3.13	3.25	1.98	10	8
61750-61754 61445-61449	30-40	3	3.69	2.38	2.87	3.13	3.25	1.98	10	4
61425-61428 61440-61443	30-40	2(at 3P)	3.69	2.38	2.87	3.13	3.25	1.98	10	4

MARS 780 Definite Purpose Contactors

MARS SERIES **614**

50-60A 3 Pole

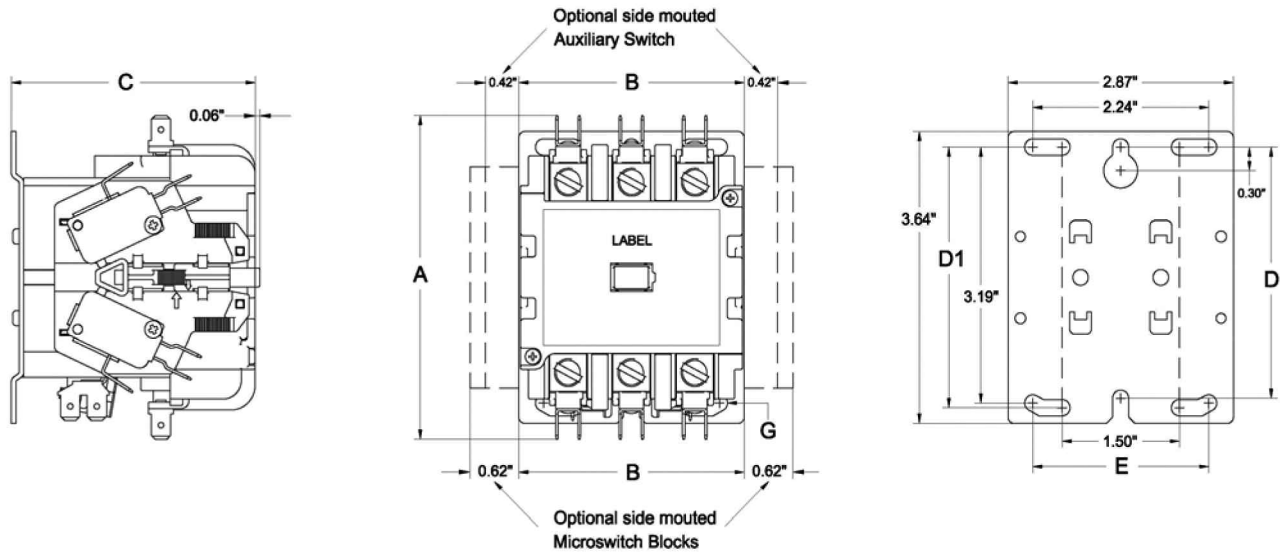

75-90A 3 Pole

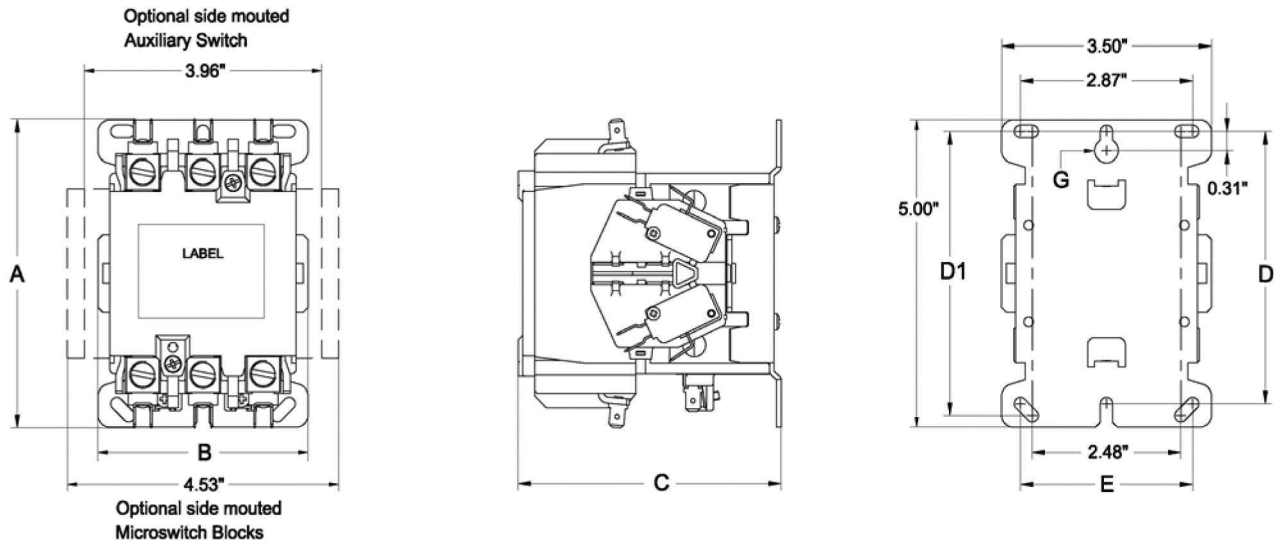

MARS No.	FLA	Poles	A	B	C	D	D1	E	Mtg Screw G	Max Wire Size
61460-61464 61470-61474	50-60	3	4.04	2.87	3.11	3.13	3.25	2.24	10	2
61480-61484 61490-61494	75-90	3	5.02	3.5	4.39	4.43	4.63	2.87	10	1/10

MARS 780 Definite Purpose Contactors

MARS SERIES **614**

Renewal Parts and Accessories

- Snap on Side Mounted Auxiliary Switches
- Replacement Coils

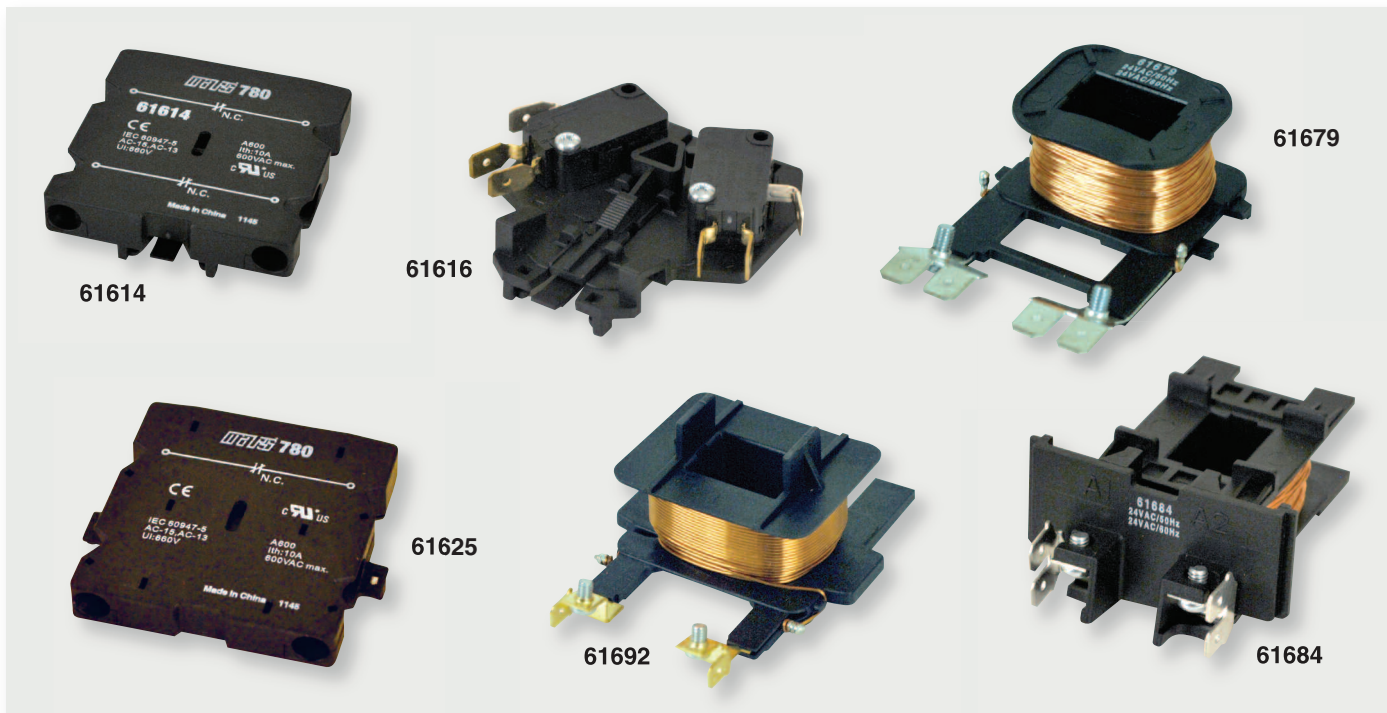

Auxiliary Switches

MARS No.	Furnas No.	Description	Contactor F.L.A.	Used On
61610	49ACRO	1 NO	30 - 60	61320-61324
61611	49ACRC	1 NC		61720-61724
61612	49ACR6	1 NO- 1 NC		61730-61734
61613	49ACR7	2 NO		61345-61349
61614	49ACR8	2 NC		61745-61749
61615	49D36098001	SPDT		61755-61759
61616	49D36098003	DPDT		61430-61434
61623	-	SPDT		61750-61754
61624	-	1 NO		61445-61449
61625	-	1 NC		61425-61428
			75-90	61440-61443
				61460-61464
				61470-61474
				61480-61484
				61490-61494

MARS 780 Replacement Coils

MARS No.	Furnas No.	Contactor Size	Coil Voltage
61679	-	3 Pole 30-40 Amp	24V
61680	-		120V
61681	-		208-240 V
61682	-		277V
61683	-		480 V
61684	-	3 Pole 50-60 Amp	24V
61685	-		120V
61687	-		208-240 V
61690	-		277V
61691	-		480 V
61692	-		3 Pole 75-90 Amp
61693	-	120V	
61694	-	208-240 V	
61695	-	277V	
61696	-	480 V	

