

EDITION 2010

MA-LINE
MONTI AND ASSOCIATES, INC.

SPECIALTY PRODUCTS FOR INDUSTRY

**FULL-LINE
PRODUCT
CATALOG**

2010

VIDEO BORESCOPE WITH RUBBER COVER

WITH PLASTIC CARRYING CASE

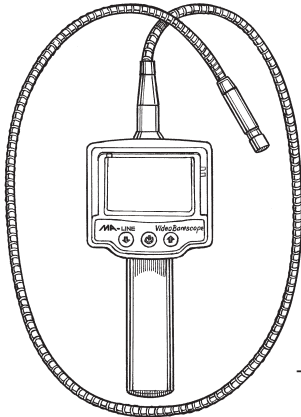

TUBE LENGTH 36"

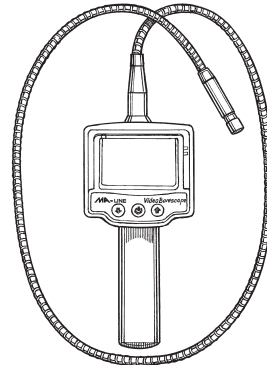

TUBE LENGTH 36"
WITH 10' EXTENSION
AND CASE

- Water resistant IP67 camera head: outer diameter 3.93", with two dimmable LEDs
- Lens: F# 2.8 viewable of angle: 54°, Focal distance: 1-1/4" - 2-1/4"
- 2.4" TFT LCD: 320 x 234 resolution
- 3 buttons operation
- On/Off
- LED light
- Up/Down
- Press Up & Down keys at the same time for turning the picture 180°
- Powered by 4 1.5V AA batteries

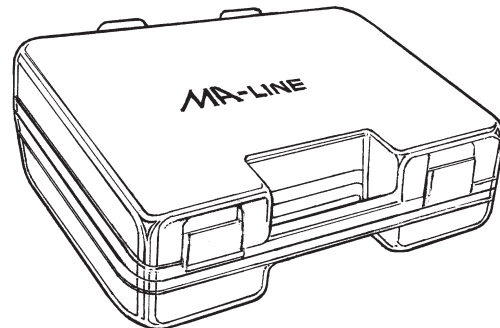

SPECIFICATIONS:

Range	Resolution
Color Mosaic	RGB Bayer Pattern
Video Format	NTSC Composite Video
Camera Illumination	2 LEDs, White
Handler End AVI Port	NTSC Signal Out
TV Cable Length	Approx. 60"
Total Length of Device	45" 3/4 "
Metal Tube Length	35" 3/4"
Diameter of Camera Head	3.93"

Part

MA-VID-1
MA-VID-2

Description

Video Borescope with Case
Video Borescope with 10' Extension and Case



Phone: 1-800-956-8220
Fax: 1-800-336-8291

ECONOMY MINI-DIGITAL MULTI-METER WITH RUBBER BOOT

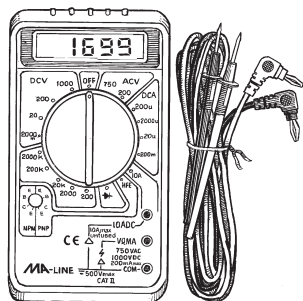

MA-DM1

FEATURES:

- Compact Design
- Manual Ranging
- Fuse Protected
- 3-1/2" digit, display
- Size: 5-1/2" x 3-1/4"
- CAT II

SPECIFICATIONS:

Function	Range
DCV	200mV, 2V, 20V 200V, 1000V
ACV (50/60Hz)	200V 750V
DCA	200µA, 2000µA, 20mA, 200mA, 10A
OHM	200Ω, 2000Ω, 20KΩ 200KΩ, 2000KΩ
Diode Test	Test current 1.6 mA: Voltage 2.8V
Transistor Test	0-1000 hFE of PNP or NPN transistors

Part	Description
MA-DM1	Mini-Digital Multi-meter
MA-DMTL	Test Lead

ECONOMY DIGITAL MULTI-METER WITH RUBBER BOOT

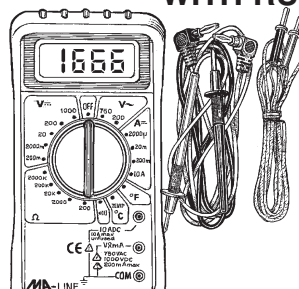

MA-DMT3

FEATURES:

- Compact Design
- Manual Ranging
- Fuse Protected
- Temperature Measurement
- K-type Probe
- Audible Continuity
- 3-1/2" Digit Display
- Size: 5-1/2" x 3-1/4"
- Backlight
- CAT II

TEMPERATURE RANGE:
-58°F TO 2498° F
(-50°C TO 1370°C)

SPECIFICATIONS:

Function	Range
DCV	200 mV, 2V, 20V, 200V, 1000V
ACV (50/60Hz)	200V 750V
DCA	200 µA, 2000 µA, 20 mA, 200 mA, 10A
OHM	200 Ω, 2000 Ω, 20 KΩ, 200KΩ, 2000 KΩ
Temperature	-58°F to 2498°F (-50°C to 1370°C)
Test Signal	50 Hz test signal appears between VΩmA and COM jacks
Audible	Red lead to VΩmA and COM jacks
Continuity	Black lead to COM.

Part	Description
MA-DMT3	Digital Multi-Meter w/Low Temperature
MA-DMTL	Test Lead
MA-DMTP	Temperature Probe

AUTO-RANGING MULTI-METER

TEMPERATURE RANGE:
-4°F TO 1400°F (-20°C TO 750°C)

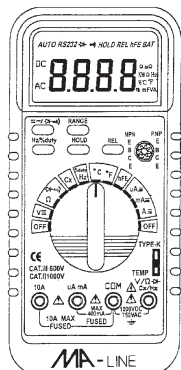

MA-12812

FEATURES:

- AC/DC selecting button
- Audible continuity
- Temperature F/C
- Capacitance
- Range control feature
- Fold out stand
- Power switch
- Relative zero button
- Range control button
- Resistance
- Continuity
- Four input jacks
- Frequency current
- AC/DC voltage
- AC/DC current
- Battery included
- CAT III-600V
- CAT II-1000V

SPECIFICATIONS:

Function	Range
DC Voltage (Auto-ranging)	400.0mv, 4.000V, 40.00V, 400.0V,1000V
AC Voltage (Auto-ranging Except 400mV)	400.0mV, 4.000V, 40.00V, 400.0V,750V
DC Current (Auto-ranging For µA and mA)	400.0µA, 4000µA, 40.00mA, 400.0mA, 10A
AC Current (Auto-ranging For µA and mA)	400.0µA, 4000µA, 40.00mA, 400.0mA, 10A
Resistance (Auto-ranging)	400.0Ω, 4.000kΩ, 40.00kΩ, 400.0kΩ, 4.000MΩ, 40.00MΩ
Capacitance (Auto-ranging)	4.000nF, 40.00nF, 400.0nF, 4.000µF, 40.00µF, 200µ
Frequency (Auto-ranging)	9.999Hz, 99.99Hz, 999.9Hz, 9.999kHz,99.99kHz, 999.9kHz,9.999MHz
Duty Cycle	0.1% ~ 99.9%
Temperature	-4°F to 1400°F (-20°C to 750°C)
Diode Test Typical	0.3mA

SEE PAGE 3 FOR ACCESSORIES

Part	Description
MA-12812	Autorangeing Multi-meter
MA-DMTL1	Test Lead
MA-DMTK	K-Type Temperature Probe
MA-MC123	Carrying Case

DIGITAL MULTI-METER WITH TEMPERATURE

BIG EASY-TO-READ DIGITAL DISPLAY
ALSO HAS MECHANICAL DOORS TO
PREVENT WRONG HOOK-UP

TEMPERATURE RANGE:
-58°F TO 2498°F (-50°C TO 1370°C)

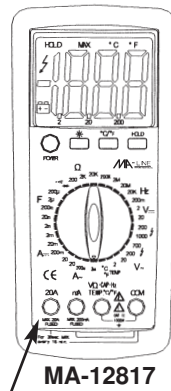

MA-12817

Mechanical doors that open and close when turning knob to prevent wrong hook-up.

FEATURES:

- Auto-off
- Backlight
- Large Easy to Read Digital Display
- Data Hold Temperature
- With Carrying Case
- K-Type Temperature Probe
- Size: 7-3/4" L x 3-1/2" W
- Audible Continuity
- CAT II

SPECIFICATIONS:

Function	Range
DC Voltage	200.0mV, 2.000V, 20.00V, 200.0V, 1000V
AC Voltage	2.000V, 20.00V, 200.0V, 700V
DC Current	2.000mA, 20.00mA, 200.0mA, 20.00A
AC Current	2.000mA, 20.00mA, 200.0mA, 20.00A
Resistance	200.0Ω, 2.000kΩ, 20.00kΩ, 200.0kΩ, 2.000MΩ, 20.00MΩ
Capacitance	2.000nF, 20.00nF, 200.0nF
Frequency	20.00kHz
Temperature	-58°F to 2498°F (-50°C to 1370°C)

SEE PAGE 3 FOR ACCESSORIES

Part	Description
MA-12817	Digital Multi-Meter w/case
MA-DMTL1	Test Lead
MA-DMTK1	K-Type Temperature Probe
MA-MC123	Carrying Case

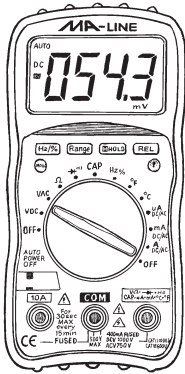

TRUE RMS AUTO-RANGING DIGITAL MULTI-METER

TEMPERATURE RANGE:
-58°F TO 2498°F
(-50°C TO 1370°C)

MA-12825

FEATURES:

- Large 2" x 1-1/2" Liquid Crystal Display with symbolic signs
- Function switch
- Frequency/Duty Cycle button
- Positive input jack for DC/AC Voltage, Hz/%duty cycle, Ohms, Diode Test, Audible Continuity, Capacitance, Temperature (°F to °C measurements)
- COM (negative) input jack
- 10A (positive) input jack for 10A DC or AC measurements
- Range pushbutton
- Data Hold pushbutton
- Relative pushbutton
- Mode pushbutton
- Backlight pushbutton
- Auto Power off
- K-Type Temperature Probe
- CAT III-600V
- CAT II-1000V

SPECIFICATIONS:

Function	Range
DC Current (Auto-ranging for uA and mA)	400.0uA, 4000uA, 40.00mA, 400.0mA, 10A
AC Current (Auto-ranging for uA and mA)	400.0uA, 4000uA, 40.00mA, 400.0mA, 10A
DC Voltage (Auto-ranging)	400.0mV, 4.000V, 40.00V, 400.0V, 1000V
AC Voltage (Auto-ranging except 400mV)	400.0mV, 4.000V, 40.00V, 400.0V, 750V
Capacitance (Auto-ranging)	4.000nF, 40.00nF, 400.0nF, 4.000µF, 40.00µF, 200.0µF
Temperature	-58°F to 2498°F -50°C to 1370°C

SEE PAGE 3 FOR ACCESSORIES

Part	Description
MA-12825	Digital Multi-Meter
MA-DMTL1	Protective Cover Test Lead
MA-DMTK1	K-Type Temperature Probe
MA-MC123	Carrying Case

AUTO-RANGING DIGITAL MULTI-METER

TEMPERATURE RANGE:
-58°F TO 1832°F
(-50°C TO 1000°C)

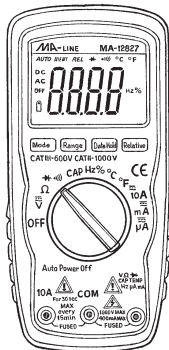

MA-12829

FEATURES:

- Continuity Test
- Diode Check
- Auto Ranging
- Data Hold
- Relative Zero
- Back Light
- Manual
- Test Leads
- Temp Leads
- Auto Power Off
- 4000 Counts LCD
- Soft Case
- 9V Battery
- CAT III-1000V

SPECIFICATIONS:

Function	Range
DC Volt	1000V +/-0.5%
AC Volt	1000V +/-0.8%
DC Current	10A +/-1.2%
AC Current	10A +/-1.2%
Resistance	40MΩ +/-0.8%
Temperature	-58°F to 1832°F (-50°C to 1000°C)
Capacitance	200uF +/-3.0%
Duty Cycle	9.99% +/-1.2%

Part	Description
MA-12829	Auto-Ranging Digital Multi-Meter

COMPACT DIGITAL MULTI-METER

TEMPERATURE RANGE:

-58°F TO 1832°F (-50°C TO 1000°C)

FEATURES:

- Continuity Test
- Diode Test
- Auto Ranging
- Data Hold
- Manual
- 9V Battery
- Test Leads
- Temp Leads
- Soft Case
- Auto Power Off
- 4000 Count LCD
- CAT III-600V

SPECIFICATIONS:

Function	Range
DC Volt	600V +/-0.5%
AC Volt	600V +/-1.2%
DC Current	10A +/-2.5%
AC Current	10A +/-1.2%
Resistance	40MΩ +/-0.8%
Temperature	-58°F to 1832°F (-50°C to 1000°C)
Capacitance	200uF +/-3.0%
Frequency	10MHz +/-1.5%
Duty Cycle	9.99% +/-1.2%

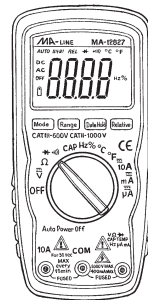

MA-12827

Part	Description
MA-12827	Compact Digital Multi-Meter
MA-DMTL1	Protective Cover Test Lead
MA-DMTK1	K-Type Temperature Probe

AC/DC DIGITAL MULTI-METER WITH AUTO SELECTION

FEATURES:

- High Performance Digital Multi-Meter with Auto Selection AC/DC Volts
- Also features Resistance, Duty Cycle, Frequency, Capacitance
- Diode Check and Continuity Test
- Auto/Manual Ranging
- 6000 count LCD

- Data Hold, MAX, MIN Recording Mode
- Auto power off
- Includes Test Leads, 9V Battery, Manual and Soft Case
- Battery 9V (1 pc)
- CAT III 600V, CAT II 1000V

SPECIFICATIONS:

Function	Range
DC Voltage	600V
AC Voltage	600V
Resistance	40MΩ
Duty Cycle	99.9%
Capacitance	40 mF
Frequency	10 MHz



MA-12837

Part	Description
MA-12837	AC/DC Digital Multi-Meter with Auto Selection
MA-DMTL1	Protective Cover Test Lead

5 IN 1 DIGITAL ENVIRONMENTAL METER 5 FUNCTIONS IN ONE METER

TEMPERATURE RANGE:
-58°F TO 2000°F
(-50°C TO 1300°C)

FEATURES:

- (1) **Sound Level**
- (2) **Light (Lux)**
- (3) **Humidity**
- (4) **Temperature**
- (5) **AC/DC Voltage**
- 3-1/2 Large LCD Display
- Auto Power Off
- K Type Thermocouple
- 9V Battery
- CAT II

SPECIFICATIONS:

Function	Range
Humidity	25% to 95% RH
Temperature	-58°F to 2000°F (-50°C to 1300°C)
Sound Level	35db to 100db
Light (Lux)	0.01 Lux to 20,000 Lux

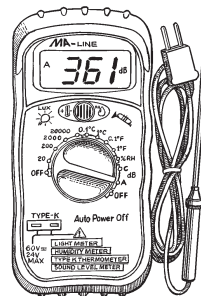

MA-12832

Part	Description
MA-12832	5 in 1 Meter
MA-DMTL1	Protective Cover Test Lead
MA-MC123	Carrying Case

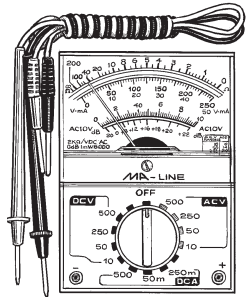

MA-12814

FEATURES:

- 5 functions, 16 measuring ranges
- 2000 Ohms/volt DC/AC sensitivity
- Single knob function switch
- Test leads & instructions
- Size 3-1/2" x 2-1/4"
- Includes (1) AA Battery
- CAT II

ANALOG MULTI-METER

SPECIFICATIONS:

Function	Range
DC Voltage	1V, 10V, 50V, 250V, 500V
AC Voltage	1V, 10V, 50V, 250V, 500V
DC Current	500µA, 50mA-250mA
Ohmmeter	Rx1k (Center 5k)

Part	Description
MA-12814	Multi-Meter
MA-DMTL4	Test Lead

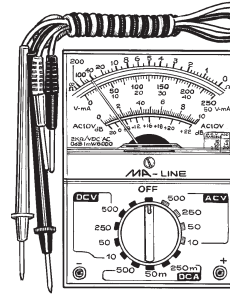

MA-12816

FEATURES:

- Single knob function switch
- Test leads & instructions
- 9V battery
- Ohmmeter: Rx1k (Center 5k)
- Audible continuity
- Size: 5-1/2" L x 3-3/4" W
- CAT II

ANALOG MULTI-METER LARGE DISPLAY

SPECIFICATIONS:

Function	Range
DC Volt	0.1V, 0.5V, 2.5V, 10V, 50V, 250V, 1000V
AC Volt	10V, 50V, 250V, 1000V,
DC Current	50µ A, 2.5m A, 25m A, 0.25 A, 10 A
Resistance	x1, x10, x100, x1K, x10K
Decibel AC	10V, 50V, 250V
ICEO	x1, x10
hFE	x10
Diode	x1K, x10, x1

Part	Description
MA-12816	Analog Multi-Meter
MA-DMTL	Test Lead
MA-MC123	Carrying Case

METER ACCESSORIES

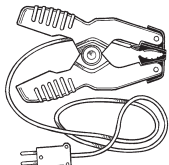

MA-12355

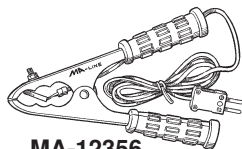

MA-12356



MA-12357

MA-12355 Pipe Clamp Temperature Lead is an ideal solution for measuring pipe temperature with any test instrument that accepts K-Type temperature leads. Clamp Jaw opening 1-38". Leads 36".

TEMPERATURE RANGE: -40°F TO 392°F (-40°C TO 200°C)

Part	Description
MA-12355	Clamp-On Probe Type K Thermometer

MA-12356 Clamp-On Probe K-Type is an ideal solution for measuring pipe temperature with any test instrument that accepts K-Type temperature leads. Clamp jaw opening 1-1/4".

TEMPERATURE RANGE: -40°F TO 1100°F (-40°C TO 590°C)

Part	Description
MA-12356	Clamp-On Probe K-Type

MA-12357 Clamp-On Probe K-Type is an ideal solution for measuring pipe temperature with any test instrument that accepts K-Type temperature leads.

TEMPERATURE RANGE: -4°F TO 300°F (-20°C TO 149°C)

Part	Description
MA-12357	Strap On Probe K-Type

METER ACCESSORIES TO BE USED ON THE FOLLOWING MODELS:

MA-12817, MA-12812, MA-12825, MA-12822, MA-12813, MA-12820, MA-16505, MA-DMT123, MA-600CF

AC CURRENT CLAMP-ON ADAPTER

FEATURES:

- Small, convenient AC current Clamp-on adapter
- Range: 200A AC
- Output: 1mV/A
- Sensitivity: 1 A/mV DC
- Accuracy: +/-2%
- CATII 600V

ADAPTER TO BE USED ON THE FOLLOWING MODELS:

MA-12817 MA-12825

Part	Description
MA-12353	Clamp-On Adapter

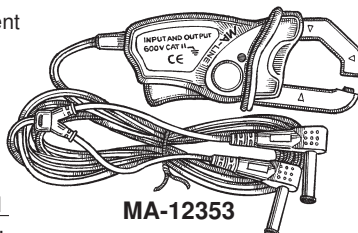

MA-12353

ANALOG CLAMP-ON METER

FIVE FUNCTIONS IN ONE METER

TEMPERATURE RANGE: -4°F TO 300°F (-20°C TO 150°C)

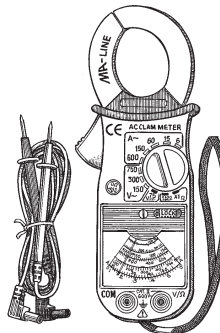

MA-12823

FEATURES:

- AC Current
- AC Voltage
- DC Voltage
- Resistance
- Temperature
- Comes with Carrying Case and Leads
- CAT II

SPECIFICATIONS:

Function	Range
AC Current	6V, 15V, 60V, 150V, 600A
AC Voltage	150V, 300V, 750V
DC Voltage	75V
Resistance	0-2kΩ, 0-200kΩ
Temperature	-4°F to 300°F (-20°C to 150°C)

Part	Description
MA-12823	Analog Clamp-on meter with case
MA-DMTL	Test Leads
MA-MC123	Carrying Case

AC/DC CURRENT CLAMP-ON ADAPTER

The AC/DC Current Clamp-On Adapter is ideal for current measurement using many compatible digital multi-meters. The adapter provides non-invasive current measurement to 4A, features a compact design, and include a non-contact voltage detector.

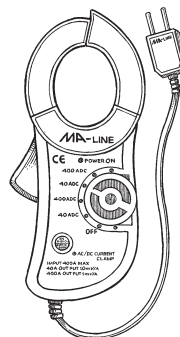

MA-12358

FEATURES:

- Hi resolution AC/DC current measurement clamp probes.
- Non-contact voltage detector
- Perfect for low current automotive, industrial control or appliance repair
- Size 5.9" x 2.3" x 1.4"
- Includes test leads
- Includes 9V battery
- Includes manual and soft case
- CAT III

SPECIFICATIONS:

Function	Range
Range	40 to 400A (AC/DC)
Output (4A)	N/A
Output (40A)	10mV/A
Output (400A)	1mV/A
Sensitivity (4A)	N/A
Sensitivity (40A)	0.1AmV AC/DC
Sensitivity (400A)	1AmV AC/DC
Basic Accuracy (4A)	N/A
Basic Accuracy (40 A)	+/- (2.5%+0.03A)
Basic Accuracy (400A)	+/- (2.8%+0.03A)
Clamp Jaw Opening	1.2" (30mm)
Non-contact Voltage Detector	50 to 600 VAC

Part	Description
MA-12358	AC/DC Current Clamp-On Adapter

ECONOMY AUTO-RANGING CLAMP-ON METER

TEMPERATURE RANGE:

-38°F TO 1750°F (-38°C TO 950°C)

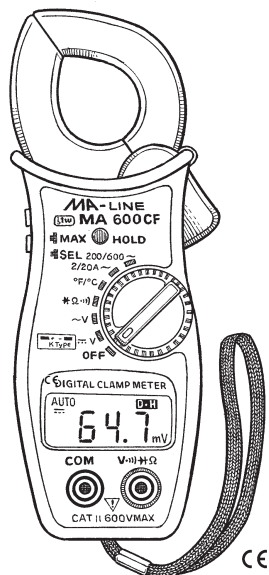

MA-600CF

FEATURES:

- Reads Volts, Amps, and OHMS
- Data Hold
- Continuity Buzzer
- Resistance• Includes All Probes
- Carrying Case
- Batteries
- CAT II

SPECIFICATIONS:

Function	Range
DC Voltage	200mV, 2V, 20V, 200V, 600V
AC Voltage	2V, 20V, 200V, 600V
AC Current	2A, 20A, 200A, 600A
Resistance	200Ω, 2kΩ, 20kΩ, 200kΩ, 2MΩ, 20MΩ
Temperature	-38°F to 1750°F (-38°C to 950°C)

SEE PAGE 3 FOR ACCESSORIES

Part	Description
MA-600CF	Auto-Ranging Economy Model
MA-DMTL1	Protective Cover Test Lead
MA-DMTK	K-Type Temperature Lead

DIGITAL CLAMP-ON METER WITH CASE

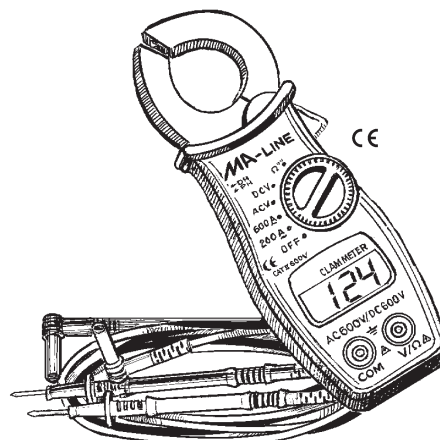

MA-DCM3

FEATURES:

- AC/DC Volt & Ohmmeter
- Tear-drop shaped jaw
- Easy-to-read 3-1/2" digit LCD screen
- Data hold & peak hold function
- Surge & overload protection in all ranges
- Continuity check with beep sound
- Includes carrying case and test leads
- 9V battery
- Size 8" x 2-3/4"
- CAT II

SPECIFICATIONS:

Function	Range
AC200A	0-199.9A
AC600A	0-600A
AC600V	0-600V
DC600V	0-600V
R2000Ω	0-1999Ω

Part	Description
MA-DCM3	Digital Clamp-On Meter
MA-DMTL1	Protective Cover Test Lead
MA-MC123	Carrying Case

DELUXE DIGITAL CLAMP-ON METER

AC/DC CURRENT & AC/DC VOLTAGE

TEMPERATURE RANGE:

-4°F TO 2498°F (-20°C TO 1370°C)

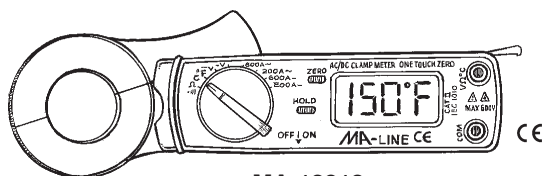

MA-12813

FEATURES:

- Temperature/continuity measurements
- Data Hold function
- AC/DC voltage
- Easy to read 3-1/2" digit LCD display
- 1-1/4" diameter jaw
- F/C selectable
- On/Off switch
- Hand strap
- Case and battery included
- Size 8" x 1-3/4"
- CAT II

SPECIFICATIONS:

Function	Range
AC Current	200A, 600A
DC Current	200A, 600A
AC Voltage	600V
DC Voltage	600V
Resistance	2000Ω
Temperature	-4°F to 2498°F (-20°C~1370°C)

SEE PAGE 3 FOR ACCESSORIES

Part	Description
MA-12813	Digital Mini-Clamp/Temperature Test Lead
MA-DMTL1	K-Type Temperature Probe
MA-MC123	Carrying Case

HVAC DIGITAL CLAMP-ON METER

FLAME SAFEGUARD CIRCUITS

AC/DC CURRENT & AC/DC VOLTAGE

TEMPERATURE RANGE:

-58°F TO 2372°F (-50°C TO 1300°C)

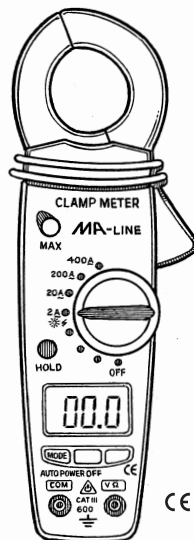

MA-12826

FEATURES:

- 4000 count LCD display
- Data Hold
- Backlight
- Max Hold
- Zero Function
- Auto Power Off
- Low Battery Indicator
- Auto Power Off
- Test μA Current Range for HVAC Purposes
- Includes temperature leads, soft case, manual & 2 AAA 1.5V batteries
- CATIII-600V

SPECIFICATIONS:

Function	Range
DC Voltage	600V
AC Voltage	600V
AC Current	400A
DC Current	4000 μA
Microamps	AC/DC μA
Resistance	40mΩ
Capacitance	100μf
Frequency	150KHz
Continuity Buzzer	sounds at 100Ω
Diode Test current	0.3mA

SEE PAGE 3 FOR ACCESSORIES

Part	Description
MA-12826	HVAC Digital Clamp-On Meter
MA-DMTL1	Protective Cover Test Lead
MA-DMTK1	K-Type Temperature Probe

DIGITAL AC/DC AUTO-RANGING CLAMP-ON METER TRUE RMS

AC/DC CURRENT & AC/DC VOLTAGE

TEMPERATURE RANGE:
-4°F TO 1400°F (-20°C TO 760°C)

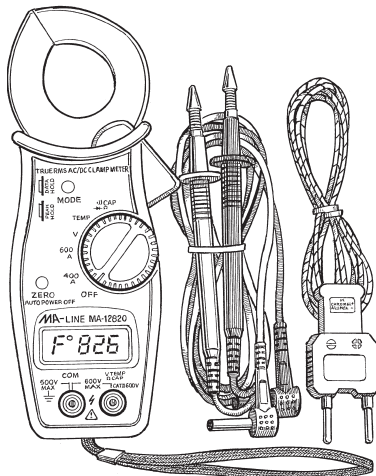

MA-12820

FEATURES:

- AC/DC current to 600A
- Resolution to 0.1A
- Data hold
- Peak hold
- DC current zero adjust
- Auto power off
- 1-1/4" jaw opening
- Carrying Case included
- 9V battery included
- CAT II

SPECIFICATIONS:

Function	Range
AC Current	400A, 600A
DC Current	400A, 600A
AC Voltage	400m, 4, 40, 400, 600
DC Voltage	4, 40, 400, 600
Resistance	400, 4k, 40k, 400k, 4m, 40m
Capacitance	40n, 400n, 4μ, 40μ, 100μ
Temperature	-4°F to 1400°F (-20°C to 760°C)

Part	Description
MA-12820	Digital Clamp-On
MA-DMTL1	Protective Cover Test Lead
MA-DMTK1	K-Type Temperature Probe
MA-MC123	Carrying Case

1000 AMP AC CURRENT AUTO RANGING, LOW TEMPERATURE CLAMP-ON METER

AC CURRENT & AC/DC VOLTAGE

TEMPERATURE RANGE:
-58°F TO 1832°F (-50°C TO 1000°C)

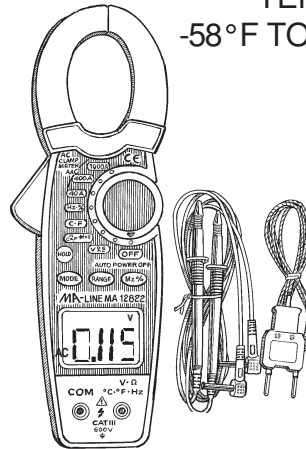

MA-12822

SEE PAGE 3 FOR ACCESSORIES

FEATURES:

- AC Current
- AC/DC Voltage
- Resistance
- Capacitance
- Temperature
- Frequency
- LCD Display with Backlight
- Data Hold
- Auto Power off
- CAT III-600V

SPECIFICATIONS:

Function	Range
AC Current	40.00A, 400.0A, 1000A
DC Voltage	400.0mV, 4.000V, 40.00V, 400.0V, 600V
AC Voltage	400.0mV, 4.000V, 40.00V, 400.0V, 600V
Resistance	400.0Ω, 4.000kΩ, 40.00kΩ, 400.0kΩ, 4.000MΩ, 40.00MΩ
Capacitance	40.00nF, 400.0nF, 4.000μF, 40.00μF, 100.0uF
Duty Cycle	0.5 to 99.0% Pulse width: 100us-100ms
Temperature	-58°F to 1832°F -50°C to 1000°C

INCLUDES:

- Carrying case
- Test Leads
- K-Type Temperature Probe
- 9-volt battery

Part	Description
MA-12822	Digital Clamp-On Meter
MA-DMTL1	Protective Cover Test Lead
MA-DMTK1	K-Type Temperature Probe
MA-MC123	Carrying Case

DIGITAL CLAMP-ON METER

AC/DC CURRENT & AC/DC VOLTAGE

TEMPERATURE RANGE:
-58°F TO 2372°F (-50°C TO 1300°C)

FEATURES:

- Measures Current, Voltage, Resistance, Temperature, Capacitance, Frequency, Continuity and Diode
- Compact body allows for easy handling and measurement in tight places
- LCD 4000 display count and backlight
- Data hold and zero function
- Auto power off and low battery indicator
- Includes soft case, manual, batteries test leads and temperature probes
- Includes (2) AAA Batteries
- CAT III-600V

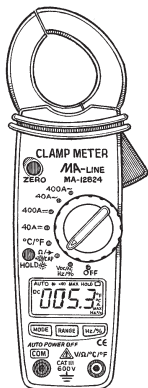

MA-12824

SPECIFICATIONS:

Function	Range
DC Voltage	600V
AC Voltage	600V
DC Current	400A
AC Current	400A
Resistance	20MΩ
Capacitance	100uF
Frequency	150KHz
Continuity Button	Sounds at 150Ω
Diode Test Current	0.3mA
Open Current	1.5V
Temperature	-58°F to 2372°F -50°C to 1300°C

SEE PAGE 3 FOR ACCESSORIES

Part	Description
MA-12824	Digital Clamp-On Meter
MA-DMTL1	Protective Cover Test Lead
MA-DMTK1	K-Type Temperature Probe

OPEN JAW CURRENT AND VOLTAGE METER

AC CURRENT & AC/DC VOLTAGE

INCLUDES:

- Manual
- Battery
- Case
- Probes

FEATURES:

- Dual LCD display
- Measure open jaw current simultaneously with other functions
- High input impedance (10Ω)
- Low battery indicator
- Data Hold
- Auto power off
- Size 8.9" x 2" x 1.6"
- Weight 8.4 oz.
- Includes (2) AA Batteries
- CAT III-600V

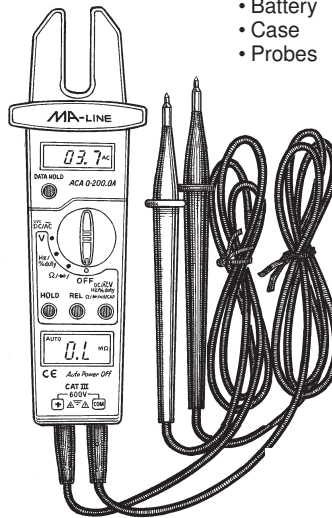

MA-12819

SPECIFICATIONS:

Function	Range
DC Voltage	600V
AC Voltage	600V
AC Current	200A
Resistance	240MΩ
Capacitance	200uF
Frequency	9,999MHz
Duty Cycle	0.1%-99.9%
Continuity Button	Provide
Diode Test Current	0.3mA Typical

Part	Description
MA-12819	Open Jaw Current and Voltage Meter

PEN PROBE STYLE DIGITAL MULTIMETER

CAT IV

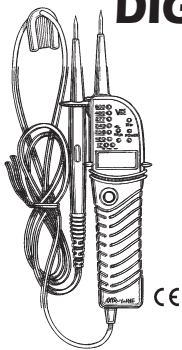

- Voltage Range: 12-600V AC/DC
- Nominal Voltage: 12/120/208/240/277/480/600V
- High Voltage indication: 100-690V AC
- Phase Rotation Test: L/R LED's for phase rotation test
- Polarity indication
- LCD
- Continuity Test
- Auto - power ON/OFF
- Pen light for illuminating measurement points
- Probes

Part MA-7339 **Description** Pen Probe Style Autoranging Digital Multimeter

PEN PROBE STYLE AUTORANGE DIGITAL MULTIMETER

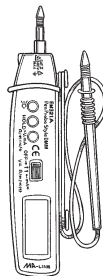

- Digital LCD Display
- With Penlight
- Auto Power Off
- Auto Ranging
- Overrange Indication
- Auto Zeroing
- Data-Hold Function

SPECIFICATIONS:

Range	Resolution
Voltage DC	200m/2/20/200/600V
Voltage AC	2/20/200/600V
Current DC	20/200mA
Current AC	20/200mA
Resistance	200/2k/20k/200k/2M/20MΩ
Capacitance	40n/400n/4μ/40μ/100μF
Continuity	Less than 50Ω
Diode Check	1.5V/.05mA

Part MA-EM3213A **Description** Pen Probe Style Autoranging Multimeter

PEN PROBE STYLE AUTORANGE DIGITAL MULTIMETER

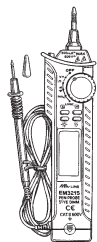

This instrument is a compact 3-1/2-digit autorange digital multimeter for measuring DC and AC voltage, DC and AC current, resistance, diode, and continuity. It has the functions of polarity indication, data hold, overrange indication, backlight, auto power-off, and flashlight.

SPECIFICATIONS:

Range	Resolution
Voltage DC	200m/2/20/200/600V
Voltage AC	2/20/200/600V
Current DC	20/200mA
Current AC	20/200mA
Resistance	200/2k/20k/200k/2M/20MΩ
Diode Check	approx. 1.5V

- Digital LCD Display
- Auto Ranging
- Backlight
- Auto Power Off
- Data-Hold Function
- Flashlight

Part MA-EM3215 **Description** Pen Probe Style Autoranging Digital Multimeter

SHIRT POCKET LASER THERMOMETER

F/C SELECTABLE

6:1 DISTANCE TO SPOT RATIO
TEMPERATURE RANGE:
-58°F TO 518°F (-50°C TO 270°C)

FEATURES:

- Large LCD Backlit Display
- Auto Power Off
- Laser Targeting
- Low Battery Indicator



Part MA-IRT203B **Description** Shirt Pocket Laser Thermometer

INFRARED THERMOMETER



10:1 DISTANCE TO SPOT RATIO
WIDE TEMPERATURE RANGE:
-58°F TO 1022°F (-50°C TO 550°C)

- Built-in Laser Pointer
- F/C Selectable Button
- Back lit LCD Display
- Data Hold and Auto Power Off
- Includes Carrying Case
- 9V Battery Included

Part MA-16509A **Description** Mini Infrared Thermometer

INFRARED THERMOMETER WITH DUAL LASER TARGETING

12:1 DISTANCE TO SPOT RATIO
TEMPERATURE RANGE:
-58°F TO 1202°F (-50°C TO 650°C)

FEATURES:

- Dual laser targeting
- Wide temperature range
- Switchable between F° and C°
- Max display and High/Low alarm
- Automatic data hold
- Auto power off
- Backlight
- Overrange indicator
- Double molded housing design
- Includes 9V battery & soft case

SPECIFICATIONS:

Function	Range
Temperature	- 58°F to 1202°F (-50°C to 650°C)
Resolution	0.1°F/°C up to 1000° 1.0°F/°C over 1000°
Emissivity	Adjustable 0.1 to 1.000
Battery	9V (1 pc)

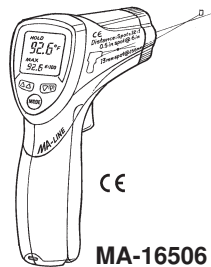

Part MA-16506 **Description** Infrared Thermometer
MA-TC123 Carrying Case

INFRARED AND K-PROBE THERMOMETER

13:1 DISTANCE TO SPOT RATIO
TEMPERATURE RANGE:
-58°F TO 1472°F (-50°C TO 800°C)
K-PROBE TEMPERATURE RANGE:
-58°F TO 2498°F (-50°C TO 1370°C)

MA-16505 InfraRed and K-probe Thermometer is ideal for temperature measurement of hard to reach areas and materials. Built-in laser pointer focuses the target for high accuracy measurements and a type-K probe allows for dual measurement. Features 20-point memory, compact, gun-type design and includes manual, battery, K-probe and case.

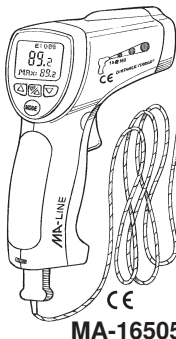

FEATURES:

- Switchable between °F & °C
- Laser targeting
- Automatic data hold
- Auto power off
- Backlit LCD display
- Overrange indicator
- Trigger lock
- Max, Min, DIF,AVG record
- High and low alarm
- Adjustable emissivity
- Type K temperature measurements
- Optical resolution (Distance to Spot ratio - DSP) 13:1
- Includes battery (9V),
- Soft case and type K probe

SPECIFICATIONS:

Function	Range
Temperature	- 58°F to 1472°F (-50°C to 800°C)
Resolution	0.1°F/°C
Type K Temperature	-58°F to 2498°F (-50°C to 1370°C)
Type K Temperature Resolution	0.1° up to 2000° 1° over 2000°
Response Time	Less than 1 second
Basic Accuracy	+/-1.5% of reading
Emissivity	Adjustable 0.10 to 1.0
Battery	9V (1 pc)
Size	7" X 4.2" X 1.9" (180mm X 106mm X 48mm)
Weight	8.8 oz (250 g)

Part MA-16505 **Description** Infrared & K-Probe Thermometer
MA-DMTK K-Probe
MA-MC123 Carrying Case

INFRARED THERMOMETER

50:1 DISTANCE TO SPOT RATIO

WIDE TEMPERATURE RANGE

-58°F TO 1900°F (-45°C TO 1037°C)

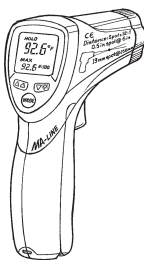

FEATURES:

- Built-in Laser Pointer
- Automatic Data Hold
- F/C Switch
- Emissivity Digitally Adjustable from 0.10 to 1.0
- MAX, MIN, DIF, AVG Temperature Displays
- Backlight LCD Display
- Automatic Selection Range and Display Resolution 0.1°F (0.1°C)
- Set High and Low Alarms
- Includes Carrying Case
- 9V Battery Included

Part	Description
MA-16551	Infrared Thermometer
MA-MC123	Carrying Case

HIGH AND LOW TEMPERATURE INFRARED THERMOMETER

12:1 DISTANCE TO SPOT RATIO

MA-16501 TEMPERATURE RANGE:
-58°F TO 1832°F (-50°C TO 1000°C)

MA-16513 TEMPERATURE RANGE:
-58°F TO 932°F (-50°C TO 500°C)

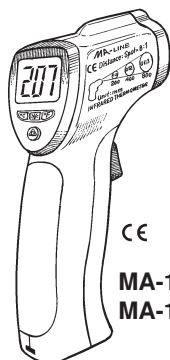

CE

MA-16501
MA-16513

FEATURES:

- Built-in Laser Pointer
- F/C Selectable Button
- Back lit LCD Display
- Data Hold and Auto Power Off
- Automatic Shut Off after 7 seconds
- Includes Carrying Case

SPECIFICATIONS:

Function	Range
Temperature	- 58°F to 1832°F
MA-16501	(-50°C to 1000°C)
Temperature	- 58°F to 932°F
MA-16513	(-50°C to 500°C)
Emissivity	0.95 fixed
Battery	9V (1 pc)

Part	Description
MA-16501	High and Low Temperature Infrared Thermometer -58°F to 1832°F (-50°C to 1000°C)
MA-16513	High and Low Temperature Infrared Thermometer -58°F to 932°F (-50°C to 500°C)
MA-MC123	Carrying Case

POCKET COMBINATION INFRARED THERMOMETER AND LED FLASHLIGHT

1:1 DISTANCE TO SPOT RATIO

TEMPERATURE RANGE:

-27°F TO 428°F (-33°C TO 220°C)

FEATURES:

- Temperature Range -27° to 428°F (-33° to 220°C)
- Distance to spot ratio 1:1
- Protective Infrared Lens Cap
- Automatic Data Hold
- Auto Off
- No Laser Sight

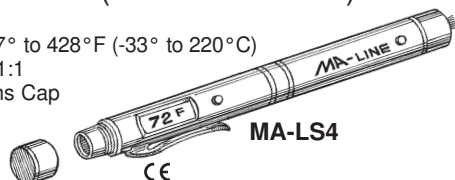

CE

MA-LS4

Part	Description
MA-LS4	Pocket Infrared Thermometer and LED Flashlight

LOW TEMP NON-CONTACT INFRARED THERMOMETER AND HUMIDITY METER

2 IN 1 METER WHICH MEASURES

TEMPERATURE AND HUMIDITY SIMULTANEOUSLY

8:1 DISTANCE TO SPOT RATIO

TEMPERATURE RANGE:

-58°F TO 932°F (-50°C TO 500°C)

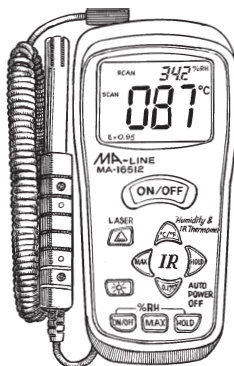

MA-16512

FEATURES:

- Dual LCD Display
- Backlit LCD Display
- Built In Laser
- F/C Switchable
- Auto Power Off
- Maximum and Hold Function for IR and RH
- Detachable Cord

SPECIFICATIONS:

Function	Range
Temperature	- 58°F to 932°F (-50°C to 500°C)
Humidity	30% to 95% RH
Sample Rate	2.5 times/second
Operating Temperatures	32° to 122°F (0° to 50°C)
Operating RH%	80% RH
Battery	9V (1 pc)
Size	6-3/4" L x 3-1/2" W x 1-3/4" H

Part	Description
MA-16512	Infrared Humidity Meter
MA-16512P	Probe
MA-MC123	Carrying Case

INFRARED THERMOMETER WITH 16" LONG FLEXIBLE NECK

8:1 DISTANCE TO SPOT RATIO

TEMPERATURE RANGE:

-58°F TO 1112°F (-50°C TO 600°C)

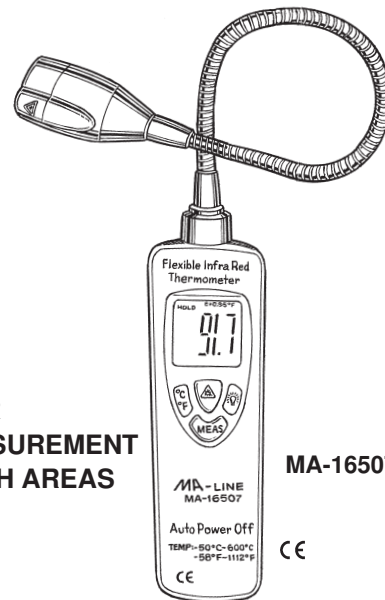

MA-16507

CE

FEATURES:

- Built in Laser pointer
- F/C Selectable
- Automatic Data Hold
- Auto Power Off
- Backlight
- Comes with Case
- 9V Battery Included

IDEAL FOR TEMPERATURE MEASUREMENT OF HARD TO REACH AREAS

Part	Description
MA-16507	Infrared Thermometer w/Flexible Neck
MA-MC123	Carrying Case

DIGITAL REFRIGERANT PRESSURE AND TEMPERATURE CHART

This is a compact digital pressure temperature chart. This pocket size device offers fast and accurate temperature references on a large easy to read LCD display. The automatic power down feature shuts the unit OFF Five minutes after the last command to insure extended battery life.

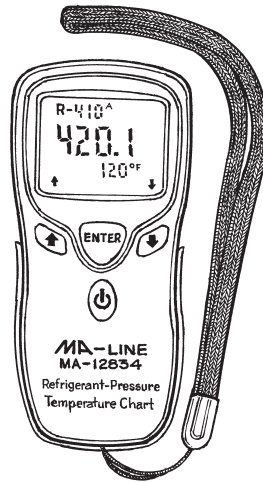

MA-12834

Pressure Units: PSI, BAR and Mpa
Temperature Units: Fahrenheit and Celsius

INCLUDES:

- Manual, Soft Case
- 3V CR2032 Battery

THE MA-12834 DISPLAYS ACCURATE PRESSURE AND TEMPERATURES FOR 61 REFRIGERANTS:

R11, R12, R13, R21, R22, R23, R32, R113, R114, R115, R116, R123, R124, R125, R134, R134A, R141B, R142B, R143, R143A, R152A, R176, R218, R290, R401A, R401B, R401C, R402A, R402B, R403A, R403B, R404A, R405A, R406A, R407A, R407B, R407C, R407D, R408A, R409A, R410A, R410B, R411A, R411B, R412A, R413A, R414A, R414B, R501, R502, R503, R504, R507, R508B, R509A, R600, R600A, R601, R601A, R717 AND R744

Part	Description
MA-12834	Digital Pressure/ Temperature Chart
KECR2032-1	Replacement Battery 1 per Card
MA-12834CS	Carrying Case

INFRARED THERMOMETER AND REFRIGERANT PRESSURE/TEMPERATURE CHART



MA-12836

13:1 DISTANCE TO SPOT RATIO
TEMPERATURE RANGE:
-22°F TO 932°F
(-30°C TO 5000°C)

- FEATURES:**
- Large, easy to read LCD screen
 - Rugged, double molded case
 - Easy to chart references of freezing devices
 - Laser targeting
 - Backlight Display
 - Auto power off
 - 9V battery

THE MA-12836 REFRIGERANT PRESSURE TEMPERATURE CHART FOR 65 REFRIGERANTS:

R11, R12, R13, R21, R22, R23, R32, R113, R114, R115, R116, R123, R124, R125, R134, R134A, R134B, R142B, R143, R143A, R152A, R176, R218, R290, R401A, R401B, R401C, R402A, R402B, R403A, R403B, R404A, R405A, R406A, R407A, R407B, R407C, R407D, R408A, R409A, R410A, R410B, R411A, R411B, R412A, R413A, R414A, R414B, R417A, R422A, R422D, R423A, R501, R502, R503, R504, R507, R508B, R509A, R600, R600A, R601, R601A, R717 and R744

Part	Description
MA-12836	Infrared Thermometer and Refrigerant Pressure/ Temperature Chart

DIAGNOSTIC PSYCHROMETER TARGET SUPERHEAT AND TARGET EVAPORATOR EXIT TEMPERATURE

TEMPERATURE RANGE:
-30°F TO 199°F (-30°C TO 100°C)

Model MA-16533 aids the HVAC technician in diagnosing problems with air flow across the evaporator. It can also calculate the Target Superheat of a fixed restrictor air condition system.

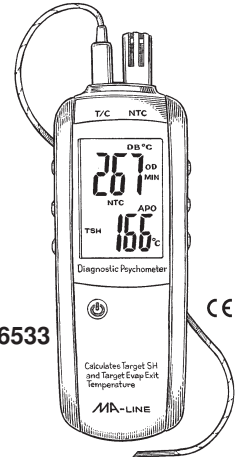

MA-16533

FEATURES:

- Calculates target superheat
- Calculates target evaporator exit temperature
- Dew point, Wet bulb and Dry bulb temperature
- User selectable NTC or Type K measurements
- User selectable F and C
- MAX, MIN, HOLD modes
- Dual digital display with backlight
- Automatic power off
- Low battery indicator
- Includes manual, battery, temperature probe and arid soft case

SPECIFICATIONS:

Function	Range
Humidity	0 to 100% RH
Type K	-58° to 2501°F (-50° to 1372 °C)
NTC	32° to 140°F (0° to 60°C)
Dew Point	-22° to 199°F (-30° to 100°C)
Wet Bulb	32° to 176°F (0° to 80°C)
Battery	9V (1 pc.)
Size	7.4" x 2.5" x 1.1" (187 x 63 x28 mm)
Weight	8.2 oz. (176g)

Part	Description
MA-16533	Psychrometer Superheat and Evaporator Exit Temperature
MA-MC123	Carrying Case

MEGOHMMETER AUTORANGING INSULATION TESTER

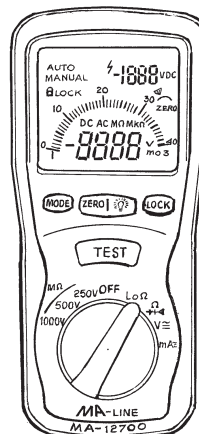

MA-12700

FEATURES:

- Auto Range for MegOhm
- Large Dual Display with Backlight
- Test Hold Function for Easy Operation
- Over Range Indication
- Low Battery Indication
- Easy to carry testing package
- 6 AA size Battery
- Carrying Case
- CAT II
- CAT III-1000V

SPECIFICATIONS:

Function	Range
AC Voltage	0.1mV-600V
DC Voltage	0.1MV-600V
Resistance	400Ω – 4000Ω
Insulation Resistance	4/40/400/4000MΩ
Test Voltage	250V/500V/1000V
Continuity Test	Active Sound Level <40V
Over range Indication	"OL" will be shown on the LCD Panel when out of range measurement is made

Part	Description
MA-12700	Megohmmeter
MA-DMTL3	Test Lead
MA-MC123	Carrying Case

DIGITAL PSYCHROMETER WITH WET BULB AND DEW POINT

TEMPERATURE RANGE:
-22°F TO 212°F (-30°C TO 100°C)



FEATURES:

- Dew Point
- Wet Bulb Temperature
- Humidity
- Fast Response Time
- High Accuracy
- Max Hold and Data Hold
- High Performance
- Dual Display
- Backlight
- Auto Power Off
- Includes Soft Case
- Response Time 0.5 seconds
- Includes 9V battery (1 pc.)

SPECIFICATIONS:

Function	Range
Humidity	0 to 100% RH
Temperature	-22°F to 212°F (-30°C to 100°C)
Dew Point	-22°F to 212°F (-30°C to 100°C)
Wet Point	32°F to 176°F (0°C to 80°C)
Temperature	32°F to 176°F (0°C to 80°C)
Size	10" x 1.8" x 1.3"

MA-16531

Part	Description
MA-16531	Digital Psychrometer with Wet Bulb & Dew Point
MA-MC123	Carrying Case

2 IN 1 DIGITAL HUMIDITY AND TEMPERATURE METER

TEMPERATURE RANGE:
-4°F TO 140°F (-20°C TO 60°C)

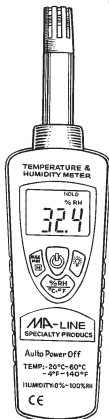

FEATURES:

- Fast Response Time
- Min/Max Data Hold Function
- Dual Display
- LCD Display
- Auto Power Off
- Backlight Button
- Includes 9V Battery
- Soft Case

SPECIFICATIONS:

Function	Range
Humidity	0 to 100% RH
Temperature	-4°F to 140°F (-20°C to 60°C)

MA-16532

Part	Description
MA-16532	Humidity/Temperature Meter
MA-MC123	Carrying Case

TEMPERATURE AND HUMIDITY DATA LOGGER WITH DISPLAY

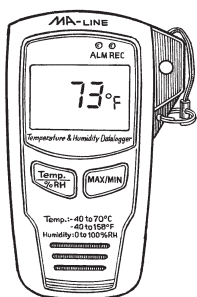

MA-16542

FEATURES:

- Memory for 32,700 values (16350 each temperature and humidity)
- LCD shows logging information
- LCD shows time and date
- Selectable measurement cycle of 1 second to 24 hours
- Download data to a PC via included USB cable
- Status displayed thru 2 LED's
- Alarm display for user-defined max and min values
- Analysis software used to view graph for logging data

- INCLUDES:**
- Battery
 - Manual
 - USB Cable
 - Software
 - Lock
 - Carrying Case

Part	Description
MA-16542	Temperature and Humidity Data Logger with Display

TEMPERATURE AND HUMIDITY DATA LOGGER

TEMPERATURE RANGE:
-40°F TO 158°F (-40°C TO 70°C)

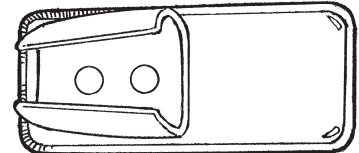
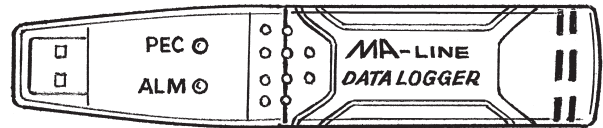

MA-16540

Temperature and Humidity Data Logger is ideal for indoor and outdoor temperature and humidity measurement over long periods of time. Status is displayed thru two LEDs. LED will turn red when user defined MAX/MIN values are Exceeded.

Readings are saved in the logger and read out by a PC thru a USB interface. Features compact design and mounting bracket. Includes manual, battery and software.

SPECIFICATIONS:

Function	Range
Humidity	0 to 100% RH
Temperature	-40°F to 158°F (-40°C to 70°C)
Memory	16,000 readings each for temperature and humidity
Measuring Rate	Selectable from 1 sec to 2 hours
Battery Life	Approximately 3 years
Analysis software	Windows 98/2000/XP
Battery	3.6V Lithium (1 pc)

Part	Description
MA-16540	Temperature & Humidity Data Logger
MA-16541	Software

VOLTAGE AND CURRENT DATA LOGGER

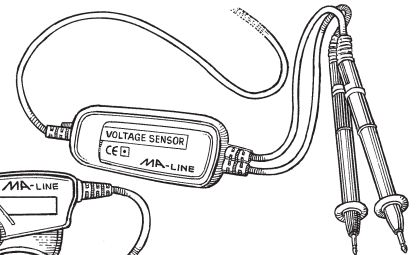
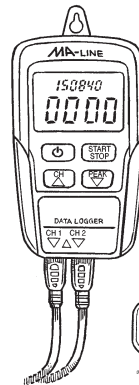

MA-16544

FEATURES:

- Dual channel input
- Digital LCD display
- AC Volt/Load Current, Leakage Current measurement
- 100,000 point data memory
- Max & Min readings in display
- Alarms sounds when user defined Max/Min values exceeded
- Time & Date in display
- Auto power off
- USB interface
- Manual & Automatic modes
- Includes voltage & current clamp sensors, USB cable
- Software CD, 3.6V Lithium (1pc) Battery and manual
- Size 4.5" x 2.5" x 1.3" 114 mm x 63 mm x 34 mm

MA-16544 Voltage & Current Data Logger is ideal for indoor and outdoor dual current and voltage measurement over long periods of time. The LCD shows logging information, time and date. Alarm signals at user defined Max/Min values. Readings are saved in the logger and read out by a PC thru a USB interface. Features compact design and mounting bracket. Includes voltage & current clamp sensors, manual, battery, USB cable and software.

SPECIFICATIONS:

Function	Range
AC Current	2 to 200A +/-2%
AC Voltage	6 to 600V +/-1.5%
Reading Memories	100,000
Measuring Rate	1 sec to 24 hr
Software	Windows 98/2000/XP/Vista

Part	Description
MA-16544	Voltage & Current Data Logger

MINI MANOMETER DIGITAL DUAL DIFFERENTIAL MANOMETER WITH MAGNET

FEATURES:

- Dual Input Range
- -55.40 to +55.40 inches water column
- Data Hold
- Provides Differential Measurements
- Low battery indicator
- Auto power off
- LCD display w/ backlight
- Accuracy +/- 0.3% Full Scale Output 77° F (25°C)
- Repeatability +/- 0.2% (Max +/-0.5% Full Scale Output)
- Linearity/Hysteresis +/- 0.29% Full Scale Output
- Maximum Pressure 10 psi
- Response Time 0.5 seconds
- Over Range Indicator Err.1
- Under Range Indicator Err.2
- Power Supply 9V battery included

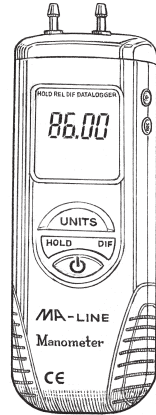

MA-12838

SPECIFICATIONS:

Function	Range
inH ₂ O	+/-55.40
psi	+/-2.000
mbar	+/-137.8
kPa	+/-137.9
inHg	-4.072 to +4.072
mmHg	+/-103.4
ozin ²	32.00
ftH ₂ O	4.612
cmH ₂ O	140.6
kgcm ²	0.140
bar	0.137

The device measures Gauge/Differential pressure from -55.4 inH₂O to +55.4 in H₂O (+/-2 psi), it features 11 selectable units of measure. Includes tubing, soft case, manual, battery and 1/8" MPT x 1/8" Barb Access Fitting.

Part	Description
MA-12838	Compact Digital Differential Manometer with Magnet
MA-MC123	Carrying Case

DIGITAL DUAL DIFFERENTIAL MANOMETER

FEATURES:

- Dual Input Range
- -55.40 to +55.40 inches water column
- Data Hold
- Provides Differential Measurements
- Low battery indicator
- Auto power off
- LCD display w/ backlight
- Accuracy +/- 0.3% Full Scale Output 77° F (25°C)
- Repeatability +/- 0.2% (Max +/-0.5% Full Scale Output)
- Linearity/Hysteresis +/- 0.29% Full Scale Output
- Maximum Pressure 10 psi
- Response Time 0.5 seconds
- Over Range Indicator Err.1
- Under Range Indicator Err.2
- Power Supply 9V battery included

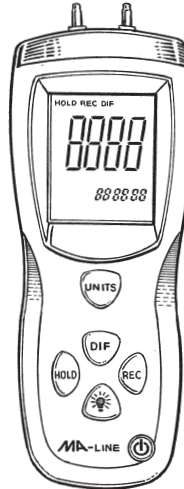

MA-12835

SPECIFICATIONS:

Function	Range
inH ₂ O	+/-55.40
psi	+/-2.000
mbar	+/-137.8
kPa	+/-137.9
inHg	-4.072 to +4.072
mmHg	+/-103.4
ozin ²	32.00
ftH ₂ O	4.612
cmH ₂ O	140.6
kgcm ²	0.140
bar	0.137

The device measures Gauge/Differential pressure from -55.4 inH₂O to +55.4 in H₂O (+/-2 psi), it features 11 selectable units of measure. Includes tubing, soft case, manual, battery and 1/8" MPT x 1/8" Barb Access Fitting.

Part	Description
MA-12835	Digital Differential Manometer
MA-MC123	Carrying Case

CARBON MONOXIDE DETECTOR

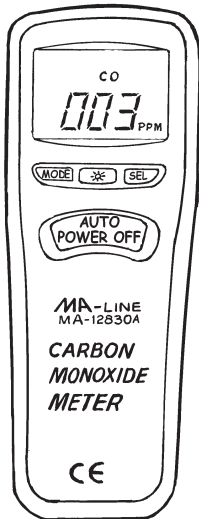

MA-12830A

FEATURES:

- Super Large 3-1/2" LCD Display
- Fast Sampling Time
- Max Hold
- Auto Power Off
- After 15 minutes of inactivity
- Auto Zero
- Memory for 10 Data Sets
- Auto/Manual Zero
- LED Light/Audible Alarm
- Record Mode
- Above 200 PPM, the beeper sounds continuously with the concentration of CO
- Warm Up Period: Less than 2 seconds
- Complete with 9V Battery
- Size: 6.3"L x 2.2"W

SPECIFICATIONS:

Function	Range
Operating Temperature	-32°F to 122°F (0°C to 50°C)
Storage Temperature	-22°F to 140°F (-30°C to 60°C)
Operating Humidity	0 - 90% RH (non-condensing)
Measurement	0 to 1000 PPM
Sensor Life	3 Years

APPLICATIONS:

- Heating, Ventilation, Air Conditioning
- Maintenance Personnel
- Heating and Chimney Flues
- Boilers
- Commercial and Domestic Cooking Appliances

Part	Description
MA-12830A	Carbon Monoxide Detector
MA-12830A-S	Replacement Sensor for MA-12830 & MA-12830A - 1 per pack
MA-MC123	Carrying Case

DIGITAL ANEMOMETER (CFM) WITH FLEXIBLE NECK

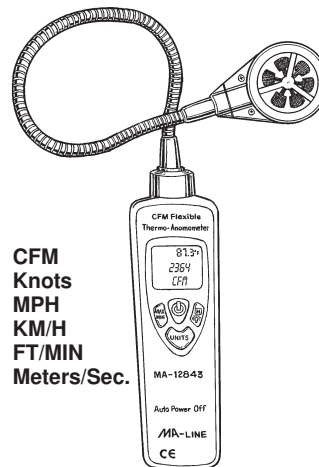

MA-12843

FEATURES:

- Measures Air Flow
- Sets Area of Measurement
- Measures Air Velocity & Temperature
- Degrees F/C Switchable
- 6 Selectable Units of Measurement
- Data Hold/Max/Min
- Mode Store
- 16 inch gooseneck detector easily measures hard-to-reach areas.
- 4 digit display of air velocity in meters/sec, ft/min, km/h, MPH, knots and CFM
- Low battery indication
- Auto-Power off
- Complete with 9V battery and carrying case

SPECIFICATIONS:

Function	Range
meters/sec	0.60-30.00
ft/min	119-5900
km/h	2.2-108.0
MPH	1.4-67.0
Knots	1.2-58.0
CFM	0-999,900ft ³ /min
F°	+14 to +140
C°	-10 to +60

CFM
Knots
MPH
KM/H
FT/MIN
Meters/Sec.

Part	Description
MA-12843	Digital Anemometer (CFM) with Flexible Neck
MA-MC123	Carrying Case

DIGITAL PHASE ROTATION INDICATOR

Model MA-12701 Phase
 Rotation Indicator detects the rotary field of three phase systems.
 Features 3 phase indication, indication of phase rotation and clear LCD display.

- FEATURES:**
- No battery is required.
 - Includes manual, leads and soft case.
 - CAT III-600V
 - CAT IV-300V

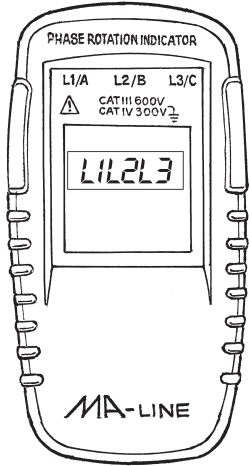

MA-12701

Part	Description
MA-12701	Phase Rotation Indicator
MA-11069	Test Leads
MA-MC123	Carrying Case

SPECIFICATIONS:

Function	Range
Nominal Voltage	40V to 690V AC
Frequency	15 to 400 Hz
Current Pickup	1mA
Nominal Test Current	1mA (per phase)
Power Supply	From Unit Being Tested
Electrical Safety	IEC61010/I/EN61010-1 IE61557-7/EN61557-7
Protection Level	CATIII 600V
Type of Protection	IP40
Operating Temperature	32°F to 104°F (0°C to 40°C)

MOTOR AND PHASE ROTATION INDICATOR

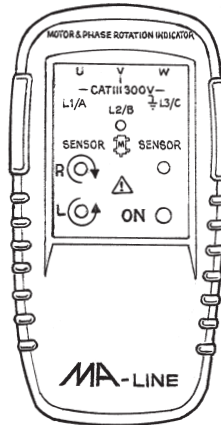

MA-12702

- FEATURES:**
- Non-contact rotary field indication, motor connection determination and magnetic field detection.
 - Includes battery, leads, manual and soft case.
 - CAT III-600V

Motor and Phase Indicator determines motor-rotation direction and detects the rotary field of three phase systems.

SPECIFICATIONS:

Function	Range
Nominal Voltage	1V to 400V AC
Nominal Voltage	120V to 400V AC
Phase Indication	
Frequency Range	2 to 400 Hz
Test Current	<3.5mA (per phase)
Electrical Safety	DIN, VDE 0411, IEC61010-1 DIN; IEC61557-7/EN61557-7
Protection Level	CATIII 600V
Type of Protection	IP40
Operating Temperature	32°F to 104°F (0°C to 40°C)

Part	Description
MA-12702	Motor & Phase Rotation Indicator
MA-11069	Test Leads
MA-MC123	Carrying Case

DIGITAL CAPACITOR TESTER

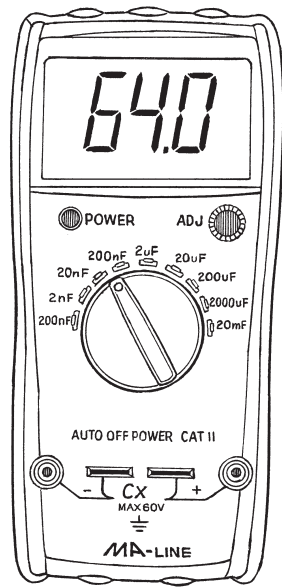

MA-12815A

- FEATURES:**
- 3-1/2" LCD display
 - Low battery indicator
 - 9V battery included
 - Fuse protected
 - CAT II

SPECIFICATIONS:

Range	Resolution
200pF	0.1 pF
2000 pF	1 pF
20nF	10 pF
200nF	100 pF
2µF	1 nF
200µF	10 nF
200µF	100 nF
200µF	1µF
20nF	10µF

Part	Description
MA-12815A	Digital Capacitor Testor
MA-DMTL1	Test Lead
MA-MC123	Carrying Case

WATT METER FOR SINGLE PHASE APPLICATIONS ONLY

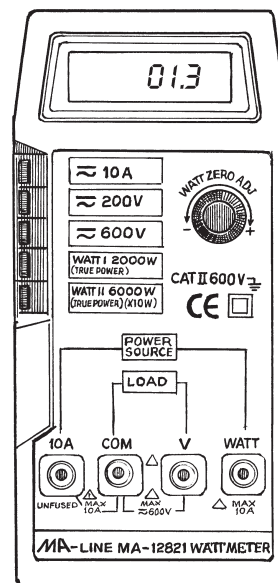

MA-12821

FEATURES:

- Measures AC watts of loads to 10A and 600VAC.
- Measures AC voltage to 600V and DC voltage to 600 V, AC and DC current to 10A.
- Monitors and evaluates power demands of single phase loads.
- Large easy to read 3-1/2" digit LCD display.
- Clearly labeled front panel controls.
- Complete with test leads and carrying case.
- Size 7" L x 3-1/2" W
- CAT II

SPECIFICATIONS:

Function	Range
Watts	0-2000W, 6000W
AC Voltage (45-60Hz)	0-200V, 600V
DC Voltage	0-200V, 1000V
Input Voltage /Current	0 to 600ACV, 1 to 10ACA
Overload Protection	600V
Input Impedance	1MΩ

Part	Description
MA-12821	Watt meter
MA-DMTL1	Test Lead
MA-MC123	Carrying Case

MICROWAVE LEAK DETECTOR

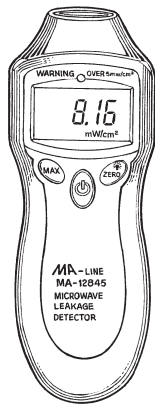

MA-12845

Detects microwaves leaking from microwave ovens FDA & EPA have set the safety standard at 5mW/cm2 LED will flash and beeper will sound when leak is above 5mW/cm2. Includes Soft Case.

SPECIFICATIONS:

Function	Range
Calibrated	2450MHZ
Range	0-9.99 mW/cm2
Warning Value	5.0mW/cm2
Battery	9V battery

Part	Description
MA-12845	Microwave Leak Detector

TACHOMETER

The MA-Line tachometer is made up of a strong lightweight ABS housing. This housing has been shaped to fit comfortably in either hand.

This unit is ideal for measuring RPM on motors, gears, pulleys, compressors and much more.

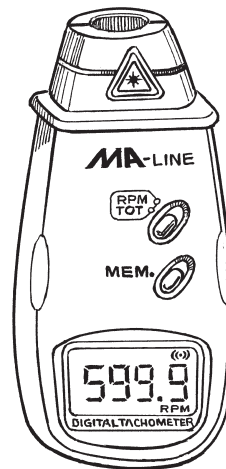

MA-12842

FEATURES:

- Auto-ranging
- Wide Measuring Range
- Memory Call Button
- Reflective Mark
- Signal Light Beam
- Laser Warning Symbol
- Measure Button
- RPM Switch
- TOT Switch (Total)
- Carrying Case

SPECIFICATIONS:

Function	Range
Test Range	2.5 to 99,999 RPM
Batteries	4-AA

Part	Description
MA-12842	Photo Non-Contact Tachometer
MA-12844	Reflective Tape
MA-MC123	Carrying Case

LCD MOISTURE INDICATOR FOR WOOD, DRYWALL OR CONCRETE

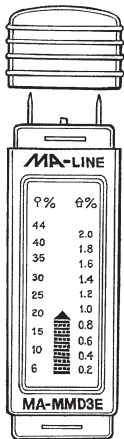

MA-MMD3E

FEATURES:

- Measures Moisture from 0-100%
- Hold Switch (Press and Hold) to Freeze the LCD Reading During Moisture Measuring.
- Low Battery Indicator
- Hold Icon Display
- Protective Cover
- Replaceable Test Probe Pins
- Battery LR44

Part	Description
MA-MMD3E	Moisture Indicator
MA-MC123	Carrying Case

LASER TAPE MEASURE MEASURES DISTANCE, HEIGHT, AREA AND VOLUME FAST AND EASY

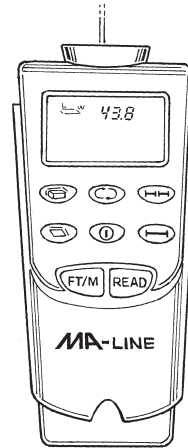

MA-7409

FEATURES:

- LED Display
- Data Recall
- On/Off Button

SPECIFICATIONS:

Function	Range
Measurement	2 ft. to 50 ft (0.6 to 15M approximately.)
Laser Indicator	
Battery	1-9V (Included)

Part	Description
MA-7409	Laser Tape Measure
MA-MC123	Carrying Case

PORTABLE GAS LEAKAGE INDICATOR NATURAL GAS AND PROPANE



MA-NG2000-A

SPECIFICATIONS:

Function	Range
Power	DC
Battery Size	2 AA
Consumption	200mA
Detectable Gas	Natural Gas Petroleum Gas
Humidity	95RH or Lower
Duration of Use	About 4 Hours Continuously

Part	Description
MA-NG2000-A	Portable Gas Indicator

POWER METAL / STUD SENSOR

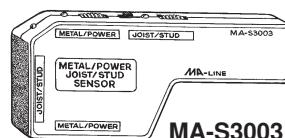

MA-S3003

Electronically locates cables, gas and water pipes. Traces hidden ceiling joists and wall studding. Helps prevent accidents when drilling or sawing. Senses presence of main power without touching live wires. Incorporates audio signal and indicator light; CE approved.

Part	Description
MA-S3003	Metal Power/Stud Sensor

DUAL PROBE DIGITAL THERMOMETER WITH CASE

TEMPERATURE RANGE:
-328°F TO 2498°F (-200°C TO 1370°C)

GREAT FOR SUPER HEAT
Available Computer Software Package allows you to download information from a digital thermometer to a PC.

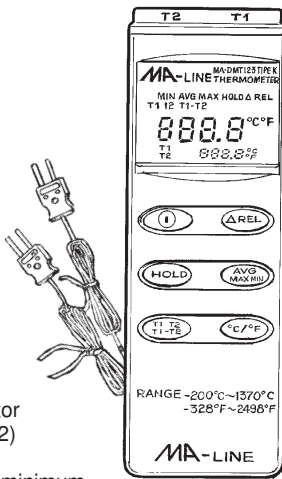

MA-DMT123

SEE PAGE 3 FOR ACCESSORIES

- FEATURES:**
- LCD Display
 - Low battery indicator
 - Dual display (T1-T2)
 - Auto power off
 - Maximum average minimum hold, related functions
 - Resolution 0.1°F (0.1°C)
 - Battery 9V
 - Size 7" x 3-1/2"

SPECIFICATIONS:

Function	Range
Temperature	-328°F to 2498°F (-200°C to 1370°C)

Part	Description
MA-DMT123	Dual Probe Thermometer
MA-DMTK	K Temperature Probe
MA-MC123	Carrying Case

CARRY ALL BLACK NYLON POUCH WITH BELT LOOP AND STRAP



DIMENSIONS:
12" L x 6" W x 2" D

Part	Description
MA-MC123	Carry All Black Nylon Pouch with Belt Loop and Strap

HAND HELD DIGITAL THERMOMETER

TEMPERATURE RANGE:
-58°F TO 392°F (-50°C TO 200°C)

- FEATURES:**
- Wide Measurement Range
 - Fahrenheit and Celsius Switchable
 - Minimum/Maximum Temperature Memory
 - Data Hold Function
 - Stainless Steel Probe
 - Magnetic Attachment
 - Never Needs to be Calibrated
 - Large and Clear Digital Display

MA-RT900

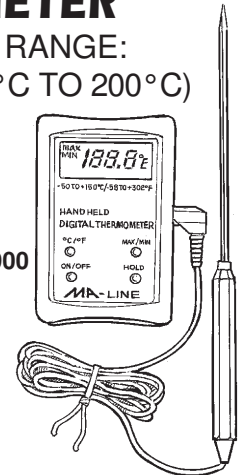

Part	Description
MA-RT900	Hand Held Digital Thermometer
MA-RT900P	Replacement Probe

ROTARY PROBE POCKET DIGITAL THERMOMETER

TEMPERATURE RANGE:
-58°F TO 392°F (-50°C TO 200°C)

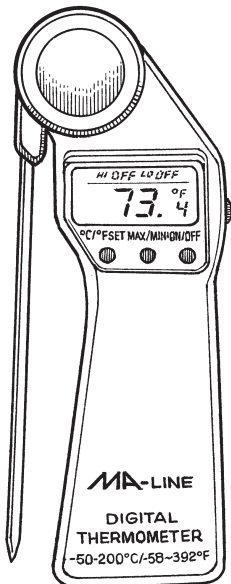

MA-RT343

- FEATURES:**
- Wide Measurement Range
 - Rotary Probe Design
 - Low Battery Indicator
 - Stainless Steel Probe
 - Pocket Size
 - Maximum / Minimum Temperature Memory
 - Data Hold Function
 - F/C Switchable
 - High / Low Temperature Alarm Setting
 - Probe Length 4-1/2"
 - For Use in Food Processing, Refrigeration Laboratory and Greenhouse

Part	Description
MA-RT343	Digital Thermometer

HAND HELD DIGITAL ALARM THERMOMETER

TEMPERATURE RANGE:
-58°F TO 392°F (-50°C TO 200°C)

- FEATURES:**
- Wide temperature range
 - Data hold function
 - High & low temperature alarm setting
 - F/C exchange
 - Never needs calibration
 - Maximum/minimum temperature memory
 - Key tone for operation confirmation
 - Stainless steel probe
 - Foldaway stand

SPECIFICATIONS:

Function	Range
Measurement	-58°F to 392°F (-50°C to 200°C)
Probe Length	5"
Probe Cord Length	40"
Battery	1-AAA

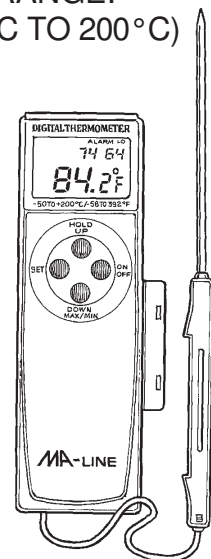

MA-RT901

Part	Description
MA-RT901	Digital Alarm Thermometer
MA-RT901P	Replacement Probe

BIG DIGIT POCKET THERMOMETER

TEMPERATURE RANGE:
-40°F TO 392°F (-40°C TO 200°C)

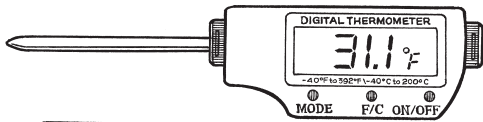

Stem Length 2-1/2"
Overall Length 6"

FEATURES:

- Stainless steel stem
- F/C selectable
- Min/Max
- Auto off
- Data hold
- Water resistant

Part	Description
MA-RT818	Large Digit Pocket Thermometer

DIGITAL THERMOMETER WITH ANTI-ROLLING DESIGN

TEMPERATURE RANGE:
-58°F TO 302°F (-50°C TO 150°C)

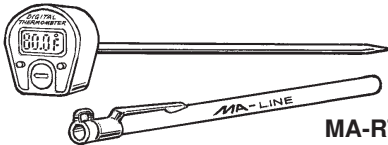

MA-RT330

The specialized design of this unit offers a temperature range of -58° F to +302° F (-50°C to +150° C), with +2° in the middle of the scale. The unit has an on/off switch, or will automatically shut off after 10 minutes without use. The anti-rolling feature of the thermometer allows the operator/user to lay the unit on top of equipment without being concerned that the unit will suddenly roll off or drop before a temperature can be read. This unit comes complete with a battery.

Part	Description
MA-RT330	Digital Thermometer

DIGITAL THERMOMETER WITH 180° ROTATING HEAD DESIGN

TEMPERATURE RANGE:
-58°F TO 302°F (-50°C TO 150°C)

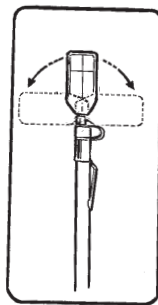

MA-RT340

This specially designed unit includes an on/off switch and an automatic shut-off after 10 minutes. It measures temperatures ranging from -58°F to 302°F (-50°C to 150°C). The accuracy is rated a 2° in the center range of the unit. This unit comes complete with battery. The unique feature of this unit is the ability to rotate the head of the unit a full 180°.

Part	Description
MA-RT340	Digital Thermometer
MA-RT340LS	Digital Thermometer same as above but with 8" Stem

POCKET DIGITAL THERMOMETER

TEMPERATURE RANGE:
-40°F to 392°F (-40°C to 200°C)



MA-PDT392B

FEATURES:

- New case design
- Stainless steel stem
- New temperature range -40°F to 392°F (-40°C to 200°C)
- High and low temperature recall
- Water resistant
- Auto off
- Data hold

Part	Description
MA-PDT392B	Pocket Digital Thermometer

DIGITAL THERMOMETER OVAL STYLE

TEMPERATURE RANGE:
-50°F to 392°F (-45°C to 200°C)

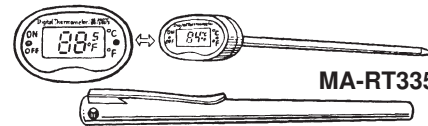

MA-RT335

FEATURES:

- Large LCD display
- New temperature range -50°F to 392°F (-45°C to 200°C)
- Accuracy ±2°F
- Anti-rolling head design
- Display updates per second
- On-Off switch
- Fahrenheit/Celsius switchable
- With plastic sheath which can also be used as a holder and pocket clip

Part	Description
MA-RT335	Digital Oval Thermometer

ADJUSTABLE POCKET DIAL THERMOMETER WITH CASE AND 5" STEM



**1" DIAL
12 TO A DISPLAY CARTON
FAHRENHEIT SCALE**

Part	Description
MA-PT160	1" -40°F to 160°F
MA-PT220	1" 0°F to 220°F
MA-PT550	1" +50°F to 550°F

BLISTER CARD
MA-PT160B 1" -40°F to 160°F
MA-PT220B 1" 0°F to 220°F

CENTIGRADE SCALE
MA-PT70C 1" -40°C to 70°C
MA-PT110C 1" -10°C to 110°C

**1 3/8" DIAL
12 TO A DISPLAY CARTON
FAHRENHEIT SCALE**

Part	Description
MA-PT138160	1 3/8" -40°F to 160°F
MA-PT138220	1 3/8" 0°F to 220°F

**1-3/4" DIAL
INDIVIDUALLY PACKAGED
WITH COMFORT ZONE!
FAHRENHEIT SCALE**

Part	Description
MA-PT134160	1 3/4" -40°F to 160°F
MA-PT134220	1 3/4" 0°F to 220°F

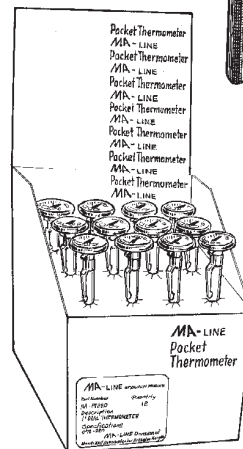

BIG DIGIT HYGRO THERMOMETER

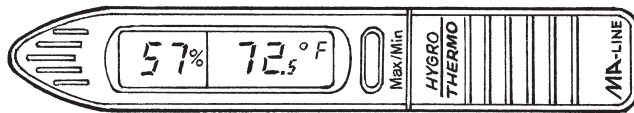

MA-RT819

FEATURES:

- Dual display for Humidity and Temperature
- Maximum and Minimum Reading Memory
- °C / °F Selectable
- Fast Reading Update
- Large and Clear Display
- Pen Shape Design

Part	Description
MA-RT819	Big Digit Hygro Thermometer

PEN TYPE TEMPERATURE/HUMIDITY

TEMPERATURE RANGE:
14°F TO 122°F (-10°C TO 50°C)

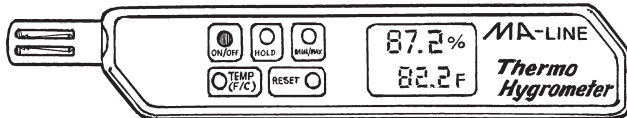

L - 1/2" L x 1-1/4" W MA-16530

FEATURES:

- F/C selectable switch
- Data Hold
- Minimum and maximum memory
- Auto power off

SPECIFICATIONS:

Function	Range
Temperature	14°F to 122°F (-10°C to 50°C)
Humidity	5% to 95% RH

Part	Description
MA-16530	Temperature Humidity

FREEZE ALERT FOR FREEZERS AND REFRIGERATORS

ALARM SOUNDS IF FOOD STARTS TO DEFROST. EXTRA LOUD AUDIBLE BUZZER WARNING AND LED ALERT.

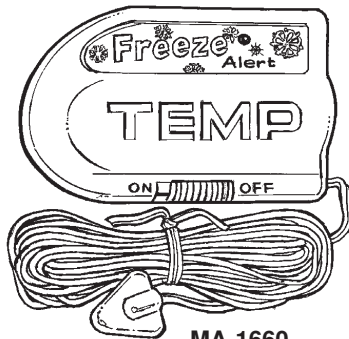

MA-1660

Preserve and protect food from spoilage. Ensures freezer is functioning properly. Alarm sounds until it is reset or until battery dies. Complete with 112" temperature probe and 1 AA battery.

Part	Description
MA-1660	Freeze Alert

DIGITAL POCKET THERMO-HYGROMETER

TEMPERATURE RANGE:
-4°F TO 122°F (-10°C TO 50°C)



MA-16529

FEATURES:

- Dual display of temperature and humidity
- Minimum and maximum readings for temperature and humidity
- F/C selectable switch
- On/Off switch
- Compact size

SPECIFICATIONS:

Function	Range
Temperature	-4°F to 122°F (-10°C to 50°C)
Humidity	10% to 95% RH

Part	Description
MA-16529	Thermo-Hygrometer

POCKET STICK THERMOMETER 5" IN LENGTH WITH PLASTIC CASE SPIRIT FILLED

FAHRENHEIT SCALE



MA-PS120

12 TO A DISPLAY CARTON

Part	Description
MA-PS120	-40°F to 160°F
MA-PS220	0°F to 220°F

FLOOD ALERT ALARM IS TRIGGERED WHEN WATER REACHES SENSOR

LED ALERT AND EXTRA LOUD AUDIBLE BUZZER WARNING

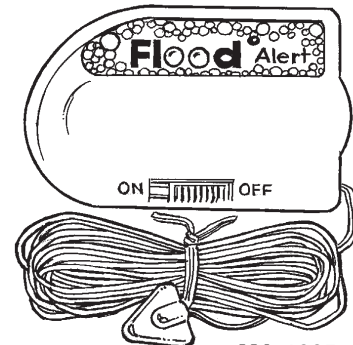

MA-1665

Detects water overflow. For use on floor, in a bathroom, or cellar, water heaters, sinks, washing machines, etc. Includes a 112" sensor cable and 1 AA battery.

Part	Description
MA-1665	Flood Alert

REFRIGERATOR/FREEZER AND OVEN THERMOMETERS

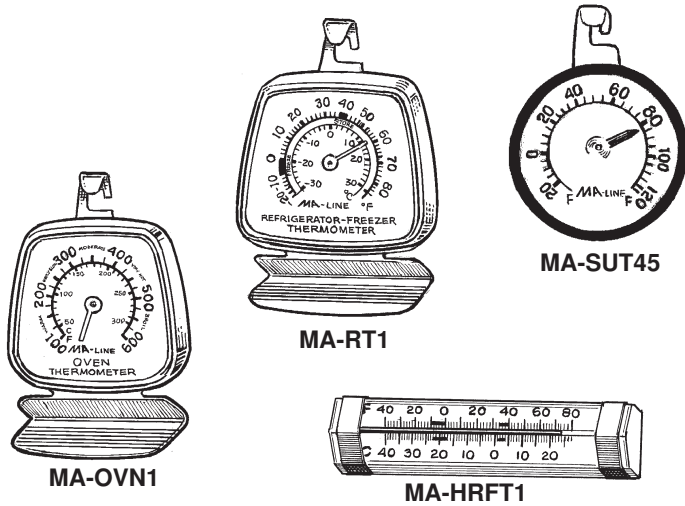

Part	Description
MA-RT1	Refrigeration freezer thermometer, -20°F to +80°F (-30°C to 30°C)
MA-OVN1	Oven thermometer, +100°F to +550°F (-50°C to 300°C)
MA-HRFT1	Horizontal refrigerator/freezer thermometer, -40°F to +80°F (-40°C to 30°C)
MA-SUT45	Stick-up thermometer, -20°F to +120°F (-30°C to 50°C)

PIPING THERMOMETER

TEMPERATURE RANGE:
-50°F TO 250°F (-40°C TO 120°C)

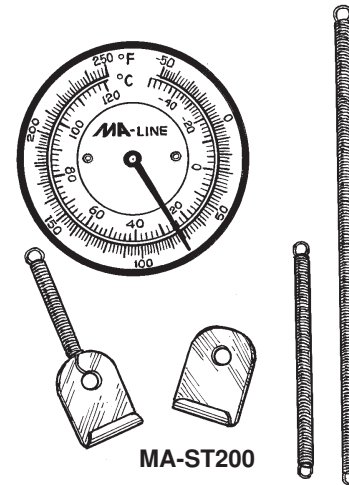

2" Spring Mounted or Surface Thermometer

Designed to measure surface temperature of pipes, cylinders, spindles, etc. that have ODs from 3/4" to 6" or more. Thermometer attaches to pipe by means of highly resilient stainless steel spring kit.

Part	Description
MA-ST200	Piping Thermometer

INDOOR/OUTDOOR HYGRO-THERMOMETER WITH CLOCK

INDOOR TEMPERATURE RANGE:

-58°F TO 158°F (-50°C TO 70°C)

OUTDOOR TEMPERATURE RANGE:

-58°F TO 158°F (-50°C TO 70°C)

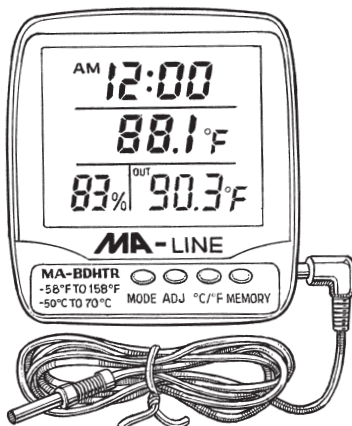

MA-BDHTR

- FEATURES:**
- Large LCD display shows both indoor and outdoor temperature and humidity.
 - Maximum and minimum temperature and humidity memory function.
 - Daily reset of min/max records function with internal clock.
 - Instant Fahrenheit/centigrade switch.
 - Wall mount or table design.

SPECIFICATIONS:

Function	Range
Indoor Temperature	58°F to 158°F (-50°C to 70°C)
Outdoor Temperature	-58°F to 158°F (-50°C to 70°C)
Humidity	20% to 90%
Sensor Cable	120"
Battery	1-AAA (included)

Part	Description
MA-BDHTR	Indoor/Outdoor Hygro/Thermometer with Clock

INDOOR/OUTDOOR THERMOMETER WITH CLOCK

INDOOR TEMPERATURE RANGE:

-4°F TO 122°F (-20°C TO 50°C)

OUTDOOR TEMPERATURE RANGE:

-4°F TO 122°F (-20°C TO 50°C)

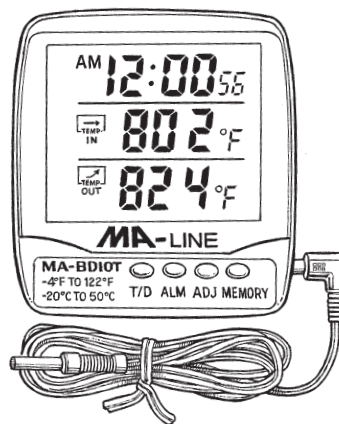

MA-BDIOT

- FEATURES:**
- Large LCD display shows both indoor and outdoor temperature
 - Memory function to recall min/max readings
 - Automatic daily update of min/max temperature reading
 - Instant Fahrenheit/centigrade switch
 - Wall mount or table design
 - AAA battery included
 - Sensor cable 108"

SPECIFICATIONS:

Function	Range
Indoor Temperature	-4°F to 122°F (-20°C to 50°C)
Outdoor Temperature	-4°F to 122°F (-20°C to 50°C)
Sensor Cable	120"
Battery	1-AAA (included)

Part	Description
MA-BDIOT	Indoor/Outdoor Thermometer with Clock

HORIZONTAL THERMOMETERS

TEMPERATURE RANGE:
-58°F TO 302°F (-50°C TO 150°C)

1-1/2" L X 1/2" H DISPLAY
Easily switchable for °F/°C applications; 48" capillary
Non Solar model uses a battery to provide power for constant display.

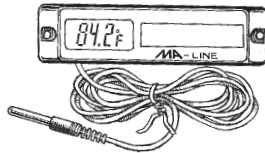

Part **MA-1001NS** **Description** Non Solar Thermometer With Battery Pack **MA-1001NS**

1-1/2" L X 1/2" H DISPLAY
Easily switchable for °F/°C applications; 48" capillary.

SOLAR!

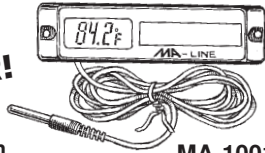

Part **MA-1001S** **Description** Solar Thermometer **MA-1001S**

SOLAR POWERED DIGITAL THERMOMETER

INDOOR TEMPERATURE RANGE:

32°F TO 122°F (0°C TO 50°C)

OUTDOOR TEMPERATURE RANGE:

-58°F TO 158°F (-50°C TO 70°C)

- Solar Powered Operation
- No Battery Required
- Maximum and Minimum Reading Memory
- °F/°C Selectable

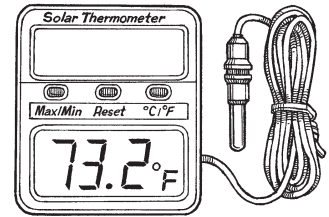

MA-RT8101

Part **MA-RT8101** **Description** Solar Powered Digital Thermometer

REMOTE READING SOLAR POWERED THERMOMETERS

TEMPERATURE RANGE:
-58°F TO 302°F (-50°C TO 150°C)

Applications: Refrigeration cabinet, freezer, cold room, supermarket showcases, food industry & other appliance application. Easily switchable for °F or °C applications. To be used in light levels above 100 lux. Front Flange Mount - All Stainless Steel Case. 2" Dial, 48" Capillary, Flush Mount, Back Connect. Temperature Range: -58°F to 302°F (-50°C to 150°C) dual scale.

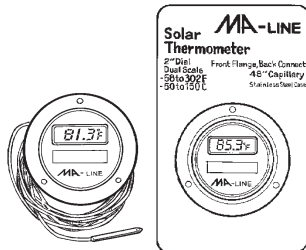

MA-2001S

Part **MA-2001S** **Description** Solar Thermometer

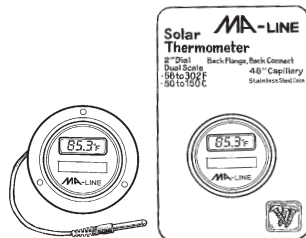

MA-2002S

2" Dial, Stainless Steel, Back Flange, Battery Backup. Dual Reading. Temperature Range: -58°F to +302°F (-50°C to 150°C.) 48" capillary. Must be used in light levels above 100 lux.

Part **MA-2002S** **Description** Solar Thermometer

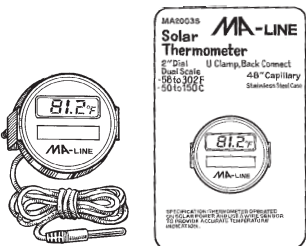

MA-2003S

2" Dial, Stainless Steel, U-clamp for Panel Mount Battery Backup. Dual Reading. Temperature Range: -58°F to +302°F (-50°C to 150°C) 48" capillary. Must be used in light levels above 100 lux.

Part **MA-2003S** **Description** Solar Thermometer

REMOTE READING VAPOR TENSION THERMOMETERS

TEMPERATURE RANGE:
-40°F TO 60°F (-40°C TO 15°C)

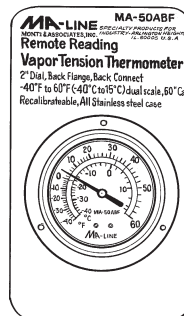

MA-50ABF

Back Flange Mount All Stainless Steel Case. 2" Dial, 60" Capillary, Back Connect. Temperature range: -40°F to 60°F (-40°C to 15°C) dual scale. This thermometer can be calibrated.

Part **MA-50ABF** **Description** Vapor Tension Thermometer

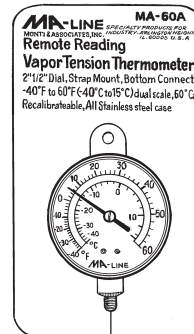

MA-60A

Strap Mount All Stainless Steel Case. 2 1/2" Dial, 60" Capillary. Temperature range: -40°F to 60°F (-40°C to 15°C) dual scale. This thermometer can be calibrated.

Part **MA-60A** **Description** Vapor Tension Thermometer

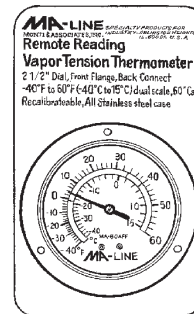

MA-60AFF

Front Flange Mount - All Stainless Steel Case. 2 1/2" Dial, 60" Capillary, Flush Mount, Back Connect. Temperature range: -40°F to 60°F (-40°C to 15°C) dual scale. This thermometer can be calibrated.

Part **MA-60AFF** **Description** Vapor Tension Thermometer

COPPER TUBE EXTENSIONS WITH 1/4" FITTING

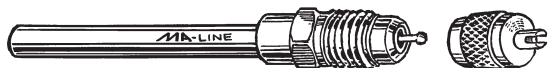

1/4" MALE FLARE

COPPER EXTENSION TUBE 2: LONG

Part	Description	Pkg. Qty.
AF1000	1/8" OD Tube Extension	5
AF1100	3/16" OD Tube Extension	5
AF1200	1/4" OD Tube Extension	5
AF1300	5/16" OD Tube Extension	5
AF1400	3/8" OD Tube Extension	5
AF1000-50	1/8" OD Tube Extension	50
AF1100-50	3/16" OD Tube Extension	50
AF1200-50	1/4" OD Tube Extension	50
AF1300-50	5/16" OD Tube Extension	50
AF1400-50	3/8" OD Tube Extension	50

CAP AND REPLACEMENT VALVE CORES

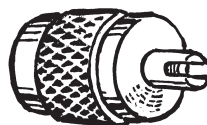

AF2000



AF2100

Part	Description	Pkg. Qty.
AF2000	1/4" SAE Gasket Seal Cap w/Core Remover	10
AF2000BX	Same as above (Boxed)	100
AF2100	1/4" Valve Core	5
AF2100-25	1/4" Valve Core	25
AF2100-100	1/4" Valve Core	100

COPPER TUBE EXTENSION WITH MULTI-STEPS



Part	Description	Pkg. Qty.
AF1500	1/8" OD, 3/16", 1/4" and 5/16" ODF Multi Steps	3
AF1600	3/16" OD x 1/8" ID, 1/4" and 3/8" ODF Multi Steps	3
AF1500-50	1/8" OD, 3/16", 1/4" and 5/16" ODF Multi Steps	50
AF1600-50	3/16" OD x 1/8" ID, 1/4" and 3/8" ODF Multi Steps	50

VALVE CORE TOOL



AF2200-M

Part	Description
AF2200-M	Metal Core Remover Tool Includes 6 Cores

COPPER SOLDER TEES WITH 1/4" MALE FLARE

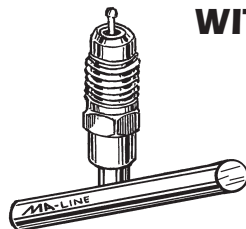

Part	Description	Price Per Pkg Qty
AF3134	1/4" OD	3
AF3135	5/16" OD	3
AF3136	3/8" OD	3
AF3138	1/2" OD	3
AF3140	5/8" OD	1
AF3142	3/4" OD	1
AF3144	7/8" OD	1
AF3148	1-1/8" OD	1

SWIVEL FLARE CONNECTION

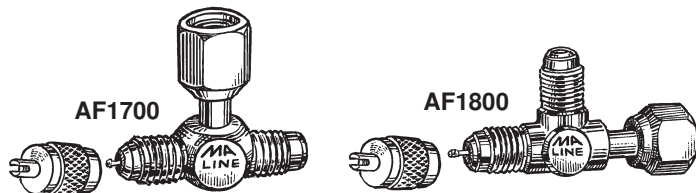

AF1700

AF1800

Part	Description	Pkg. Qty.
AF1700	1/4" Fe SAE Swivel Nut On Branch	3
AF1800	1/4" Fe SAE Swivel Nut On Run	3
AF1700-50	1/4" Fe SAE Swivel Nut On Branch	50
AF1800-50	1/4" Fe SAE Swivel Nut On Run	50

MULTI-STEP BRASS BODY



AF1900

Part	Description	Pkg. Qty.
AF1900	1/8" ODS x 3/16", 1/4" Or 5/16" ODF Steps	3
AF1900-50	1/8" OD x 3/16", 1/4" Or 5/16" ODF Steps	50

COPPER TUBE EXTENSIONS WITH 5/16" FITTING

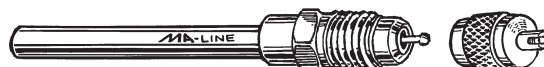

5/16" MALE FLARE

COPPER EXTENSION TUBE 2: LONG

Part	Description	Pkg. Qty.
AF11516	3/16" OD Tube Extension	3
AF12516	1/4 OD Tube Extension	3
AF13516	5/16" OD Tube Extension	3

ADJUSTABLE LINE TAP VALVE

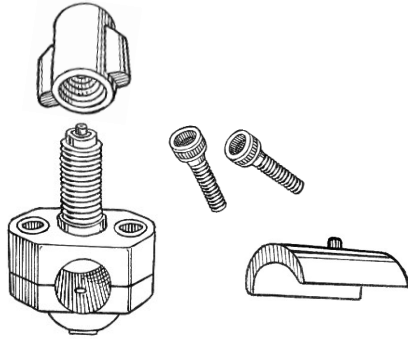

Part Description
MA-V1 Adjustable Line Tap Valve for 1/4", 5/16" 3/8" O.D. Tube
MA-V2 Adjustable Line Tap Valve for 1/2", 5/8" O.D. Tube

3-IN-1 12 OZ. CAN TAP 1/4" SAE

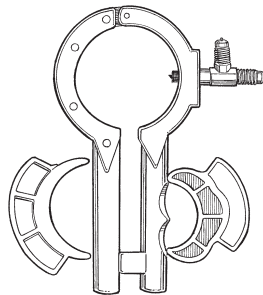

Part Description
MA-49116 3-IN-1 12 oz. Can Tap
 1/4" SAE, 1/2" ACME,
 R12, R134A

CAPILLARY TUBE CUTTER

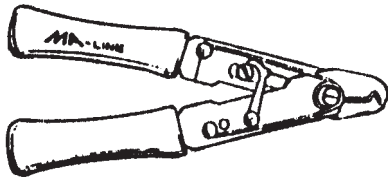

This new Capillary Cutter from the MA-Line makes it easy to make precision and easy cuts to small copper and other capillary tubes on the job. When used correctly it minimizes burrs, and leaves a clean straight cut. Made from hardened steel, and warranted for one year.

Part Description
MA-CL1 Capillary Tube Cutter

DEFROST THERMOSTATS

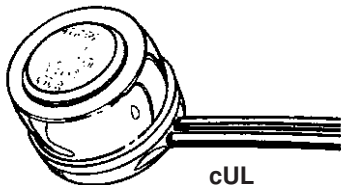

cUL LISTED

The "ML" Series Thermostats are furnished with 24" leads. They also meet all O.E.M. tolerance specifications.

- FEATURES:**
- 10 Amps @ 120 VAC
 - 5 Amps @ 250 VAC

Part	Description
32745	ML Series 45 Temp (F) Open 45 Close 25
32750	ML Series 50 Temp (F) Open 50 Close 30
32755	ML Series 55 Temp (F) Open 55 Close 35
32760	ML Series 60 Temp (F) Open 60 Close 40
32770	ML Series 70 Temp (F) Open 70 Close 50
32780	ML Series 80 Temp (F) Open 80 Close 30
32790	ML Series 90 Temp (F) Open 90 Close 35

COPPER SPUN DRIERS DRIERS CONTAIN XH-9 DESICCANT

For use on both domestic and commercial refrigerators, freezers and air conditioners. All the driers listed are compatible with all the refrigerants.

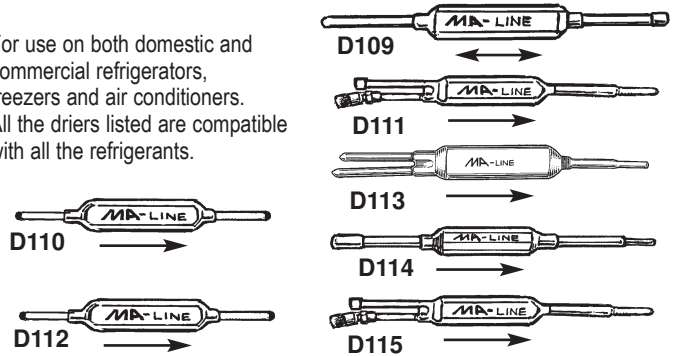

SPECIFICATIONS:

SIZE CHART

Part No.	Drops of Water Removed				Recommended Tonnage	
	75° R-12	125° R-12	75° R-22	125° R-22	R-12	R-22
D109	38	34	34	32	1/3	1/2
D110	38	34	34	32	1/3	1/2
D111	74	68	68	64	3/4	1
D112	99	93	95	90	1	2
D113	74	68	68	64	3/4	1
D114	74	68	68	64	3/4	1
D115	38	34	34	32	1/3	1/2

Part No.	Description	Dia.	Length	Inlet	Outlet
D109	Non Directional Drier	3/4"	8-1/2"	1/4"	1/4"
D110	Directional Fused Ends Drier	3/4"	8-3/4"	1/4"	1/4"
D111	Directional Charging Drier	1"	8-3/4"	1/4"	1/4" or Cap
D112	Directional Step Down Drier	1"	10-3/4"	5/16"	5/16"
D113	Directional Double Inlet Drier	1"	8-3/4"	(2) 1/4"	1/4"
D114	Directional Fused Ends Drier	1"	9"	multiple	1/4"
D115	Directional Charging Drier	3/4"	9"	1/4" ID, 1/4 OD, 1/4" Flare	1/4"

MINI PRESSURE SWITCHES

FEATURES:

- 18" Leads
- Mounting: 1/4" Female S.A.E.
- Direct Mounting on Tubing
- Contacts are rated at 6 amps, 24-240 volts.
- Low pressure switches are normally open.
- High pressure switches are normally closed and open on pressure rise
- Automatic Reset
- Tamper proof

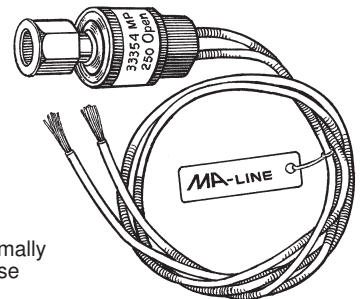

cUL LISTED

Part	Description
33329	Mini Pressure Switch Low PSI Open 5 Close 20
33330	Mini Pressure Switch Low PSI Open 10 Close 20
33362	Mini Pressure Switch Low PSI Open 20 Close 50
33363	Mini Pressure Switch Low PSI Open 20 Close 80
33364	Mini Pressure Switch Low PSI Open 40 Close 90
33353	Mini Pressure Switch High PSI Open 200 Close 150
33354	Mini Pressure Switch High PSI Open 250 Close 150
33355	Mini Pressure Switch High PSI Open 300 Close 200
33356	Mini Pressure Switch High PSI Open 350 Close 250
33357	Mini Pressure Switch High PSI Open 400 Close 200
33358	Mini Pressure Switch High PSI Open 400 Close 300
33359	Mini Pressure Switch High PSI Open 450 Close 250

WORLD SOURCE VIBRATION ELIMINATORS (IMPORT)

UL & CE
APPROVED

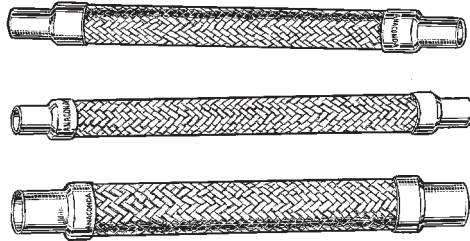

SUITABLE FOR USE WITH REFRIGERANTS

R12	R401A	R407A	R410A
R22	R401B	R407B	R410B
R23	R402A	R407C	R502
R125	R402B	R408A	R507
R134A	R404A	R409A	R508
			R509

STAINLESS STEEL VIBRATION ELIMINATORS WITH FEMALE COPPER ENDS

Part No.	Actual OD of Copper Tubing (in.)	Dimensions (in.)					Max. Working Pressure (psig.)	Burst Pressure (psig.)
		A. (I,D)	B (±1/8)	C (±1/8)	D (±1/4)	E (±1/16)		
VE14OD	1/4	1/4	3/4	6-5/8	8-1/16	1/2	500	2500
VE38OD	3/8	3/8	13/16	6-15/16	8-9/16	1/2	500	2500
VE12OD	1/2	1/2	7/8	7-1/4	9	1/2	500	2500
VE58OD	5/8	5/8	15/16	8	9-7/8	11/16	500	2500
VE34OD	3/4	3/4	1-1/4	8-1/16	10-9/16	11/16	500	2500
VE78OD	7/8	7/8	1-7/16	9-1/8	12	13/16	500	2500
VE118OD	1-1/8	1-1/8	1-13/16	9-7/16	13-1/16	13/16	500	2500
VE138OD	1-3/8	1-3/8	2	11-1/2	15-9/16	7/8	500	2500
VE158OD	1-5/8	1-5/8	2-1/4	12-3/8	16-7/8	15/16	500	2500
VE218OD	2-1/8	2-1/8	2-3/4	15-3/16	20-5/8	15/16	390	1950
VE258OD	2-5/8	2-5/8	3-1/8	18-1/16	24-5/16	1-1/4	340	1700
VE318OD	3-1/8	3-1/8	3-7/16	20	26-15/16	1-1/2	300	1500
VE358OD	3-5/8	3-5/8	4-1/8	24	32-3/16	1-9/16	175	525
VE418OD	4-1/8	4-1/8	4-7/16	24	32-15/16	1-9/16	175	525

EACH UNIT IS SEALED WITH DESICCANT IN PLASTIC BAGS AND INDIVIDUALLY BOXED.

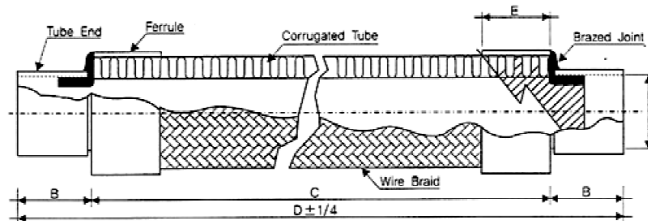

ANACONDA / UNIVERSAL VIBRATION ELIMINATORS

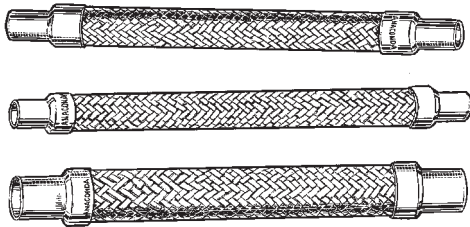

Bronze Vibration Eliminators with female ends

SUITABLE FOR USE WITH REFRIGERANTS

R12	R401A	R407A	R410B
R22	R401B	R407B	R412A
R23	R402A	R407C	R502
R125	R402B	R408A	R507
R134A	R404A	R409A	R508
		R410A	R509

Where the Refrigerant saturation pressure at 125°F (high side) and 80°F (low side) is less than the components rated design pressure.

BRONZE VIBRATION ELIMINATORS WITH FEMALE ENDS

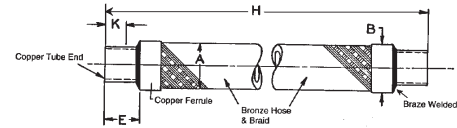

Part No.	To Fit Copper Tube		Flexible Hose I.D. (in.)	Dimensions				Maximum Operating Pressure PSI
	Actual O.D. (in.)	Nom. (in.)		H±1/4 (in.)	A Max. (in.)	B Max. (in.)	E±1/8 (in.)	
3618FZ	1/4	1/8	3/16	7	1/2	9/16	1/2	700
1418FZ	1/4	1/8	1/4	7-1/2	9/16	5/8	1/2	700
5614FZ	3/8	1/4	5/16	8-1/4	11/16	3/4	5/8	700
3838FZ	1/2	3/8	3/8	9	3/4	7/8	3/4	500
1212FY	5/8	1/2	1/2	9-3/4	1	1-1/8	7/8	450
1258FY	3/4	5/8	1/2	10	1	1-1/8	1	450
3458FY	3/4	5/8	3/4	11-1/4	1-3/8	1-1/2	1-1/8	450
3434FY	7/8	3/4	3/4	11-1/2	1-3/8	1-1/2	1-1/4	450
1010FY	1-1/8	1	1	13	1-5/8	1-7/8	1-1/2	450
5454FY	1-3/8	1-1/4	1-1/4	14-3/4	2-1/8	2-1/4	1-5/8	500

STAINLESS STEEL VIBRATION ELIMINATORS WITH FEMALE ENDS

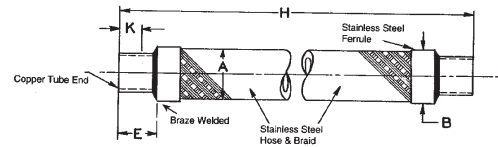

Part No.	To Fit Copper Tube		Flexible Hose I.D. (in.)	Dimensions				Maximum Operating Pressure PSI
	Actual O.D. (in.)	Nom. (in.)		H±1/4 (in.)	A Max. (in.)	B Max. (in.)	E±1/8 (in.)	
6464FS	1-5/8	1-1/2	1-1/2	17	2-1/4	2-3/8	2	400
2020FS	2-1/8	2	2	20	3-1/8	3-1/4	2-1/2	360
5252FS	2-5/8	2-1/2	2-1/2	24	3-3/4	3-7/8	3	300
3030FS	3-1/8	3	3	27	4-3/8	4-1/2	3-1/2	300
7272FS	3-5/8	3-1/2	3-1/2	23	4-5/8	4-15/16	3-3/16	150
4040FS	4-1/8	4	4	25	5-5/16	5-3/4	4-3/8	150
5050FS	5-1/8	5	5	27-1/2	6-1/4	—	5-1/2	150
6060FS	6-1/8	6	6	33	7-1/4	—	6-1/2	150
8080FS	8-1/8	8	8	42-1/2	9-1/2	—	7	150

NOTES: 1. Maximum test pressure 1-1/2 x operating pressure shown. 2. Minimum burst pressure 5 x operating pressure shown. 3. I.D. of copper tube ends for depth "K" meets ANSI STD B16.18 1978 and ANSI B16.22 1973. 4. Copper tube ends to fit sizes above 3-1/8" O.D. are commercial parts and E&H may exceed tolerances shown. 5. Bagged and boxed. Size 5"-8" are bagged only.

"QUICK-PIERCE" REFRIGERANT RECOVERY TOOL

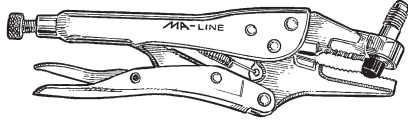

Part	Description
MA-QP400	"Quick-Pierce" Refrigerant Recovery Tool
MA-QP400-12	Replacement Piercing Tips, 1 per pack
MA-QP400-G	Replacement Gasket Only

6 IN 1 SWAGGING TOOL

6 SIZES: 3/16", 1/4", 5/16", 3/8", 1/2", AND 5/8" OD TUBING



MA-49318

Part	Description
MA-49318	6 In One Swagging Too

4 IN 1 VACUUM/CHARGE VALVE AND CORE TOOL

BALL VALVE STYLE, WITH SIDE PORT

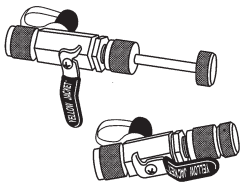

Removes and replaces Schrader cores without losing charge.
5/16" Valve core tool for use with R-410A systems.

Part	Description
MA-18975	1/4" with side port
MA-18985	5/16" with side port

5/16" ADAPTER FOR R-410 SYSTEMS

Allows for easy hook-up for R-410A mini-splits when charging the system. (1/2-20 threads).

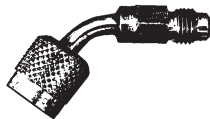

Part	Description
MA-19173	5/16" Female x 1/4" Male Adapter

HEX KEY SETS FOLDING IN POUCH

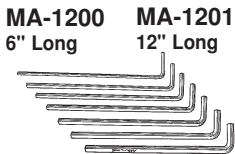

MA-1200 6" Long
MA-1201 12" Long

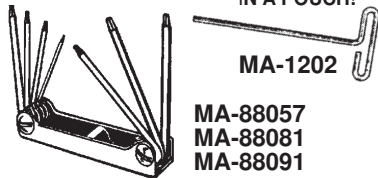

8 PIECE HEX SET IN A POUCH!

MA-1202

MA-88057
MA-88081
MA-88091

Part	Description
MA-88057	Torx 7 pc. fold up set, sizes T-10, T15, T20, T25, T27, T30, T40
MA-88081	8 pc Hex key set—Fold up sizes .050", 1/16", 5/64", 3/32", 7/64", 1/8", 9/64", 5/32"
MA-88091	9 pc. Hex key set—Fold up sizes 5/64", 3/32", 7/64", 1/8", 9/64", 5/32", 3/16", 7/32" 1/4"
MA-1200	7 pc. Hex key set—6" long 3/32", 5/64", 1/8", 5/32", 3/16", 7/32", 1/4"
MA-1201	7 pc. Hex set in pouch—12" long 3/32", 5/64", 1/8", 5/32", 3/16", 7/32", 1/4"
MA-1202	8 pc. 9" T-handle hex wrench set 3/32", 7/64", 1/8", 9/64", 5/32", 3/16", 7/32", 1/4"

LOCKING PINCH-OFF TOOL

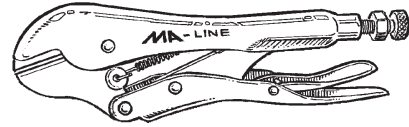

Part	Description
MA-1RR	Locking Pinch-Off Tool

DEBURRING TOOLS



MA-49310



MA-49316
Extra Replacement Blade Included

Part	Description
MA-49310	Deluxe De-Burring Tool
MA-493114	Replacement Blades for MA-49310 5 Blades per package
MA-49316	All Metal De-Burring Tool Fixed Blade

INNER / OUTER REAMER

CAPACITY:
1/8" TO 1-5/8" OD

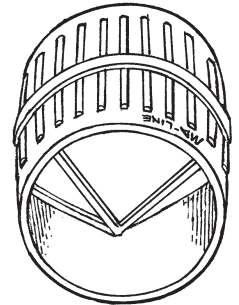

Part	Description
MA-49317	Inner / Outer Reamer

3 PIECE OFFSET SCREWDRIVER SET

#3 x 5/16" standard
#2 x 1/4" standard
#1 x 3/16" standard

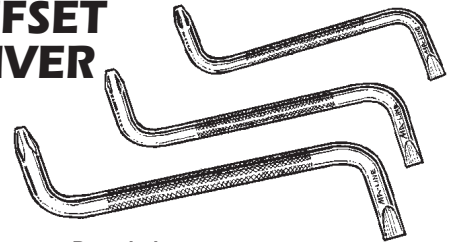

Part	Description
MA-70059P	Screwdriver set

NUT DRIVER SET 7-PIECE AND REPLACEMENT NUT DRIVERS HOLLOW SHAFT

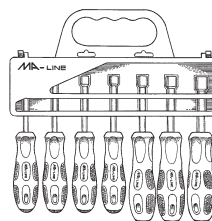

Part	Description
MA-9355	Nut driver set in pouch Sizes 3/16", 1/4", 5/16", 11/32" 3/8", 7/16" & 1/2"
MA-9306	3/16" Nut Driver, Hollow Shaft
MA-9308	1/4" Nut Driver, Hollow Shaft
MA-9310	5/16" Nut Driver, Hollow Shaft
MA-9311	11/32" Nut Driver, Hollow Shaft
MA-9312	3/8" Nut Driver, Hollow Shaft
MA-9314	7/16" Nut Driver, Hollow Shaft
MA-9316	1/2" Nut Driver, Hollow Shaft

FIN COMBS

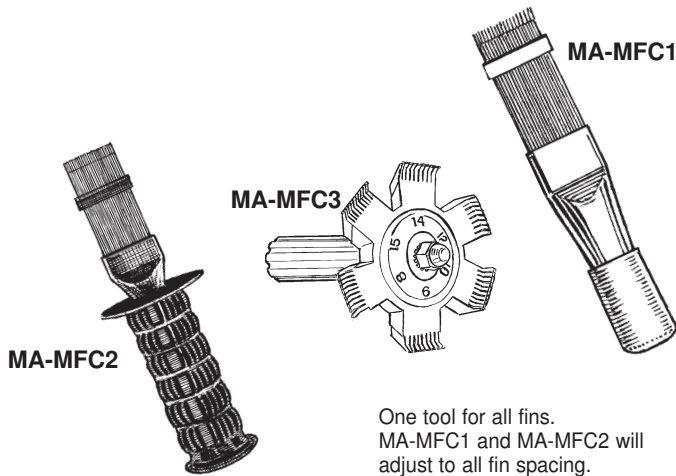

One tool for all fins.
MA-MFC1 and MA-MFC2 will adjust to all fin spacing.

Part	Description
MA-MFC1	All Metal Fin Comb
MA-MFC2	Metal Fin Comb with Handle
MA-MFC3	6 in 1 Fin Comb. For fins having spacings of 8, 9, 10, 12, 14, & 15 fins/inch (Nylon combs)

HUB PULLER

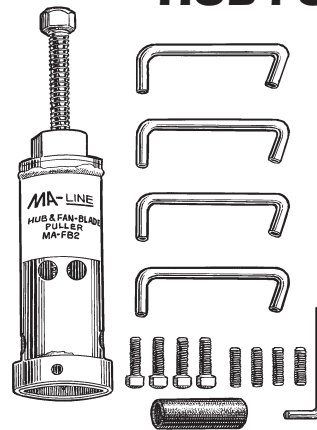

FEATURES:

- Hardened Chrome Moly
- 5/8" Steel Center Shaft
- Alignment Tool Included

MA-LINE HUB PULLER is 2 pullers in one! Pull off fan blades and blower wheels. Made of long lasting heavy steel construction. Bar top for easy gripping with a wrench. Hardened steel fingers to remove fan blades with unaccessible hubs. MA-FB2 is made of hardened steel.

Part	Description
MA-FB2	Hub Puller

HOLE SAW KITS

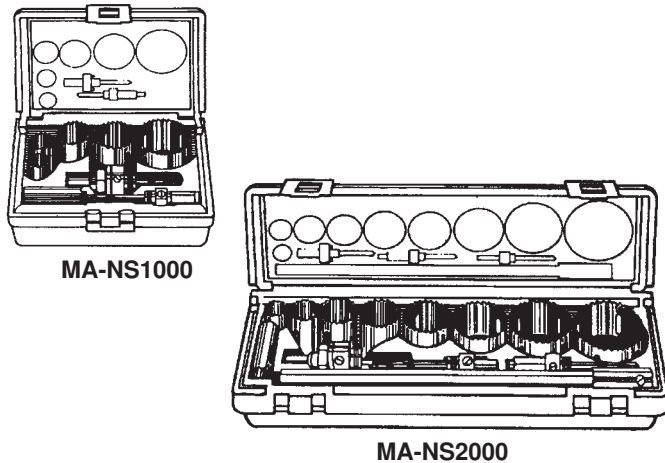

Part	Description
MA-NS1000	6 Piece - 6 Saws contains 1 each: 3/4", 7/8", 1-1/8", 1-1/2", 1-3/4", 2-1/4" hole saws plus NS1 and NS2 arbors in plastic case
MA-NS2000	9 Piece - 9 saws contains 1 each: 3/4", 7/8", 1-1/8", 1-3/8", 1-1/2", 1-3/4", 2", 2-1/4", 2-1/2" hole saws plus NS1, NS2, NS3 arbors & pilot drill in plastic case
Replacement Hole Saws, Arbors and Extensions	
MA-NS1	7/16" Hex Shank Arbor 9/16" to 1-1/8" Hole Saws 1/2" x 20 Thread
MA-NS2	7/16" Hex Shank Arbor 1-1/4" to 6" Hole Saws 5/8" x 18 Thread
MA-NS12	3/4" Bi-Metal Hole saw
MA-NS14	7/8" Bi-Metal Hole saw
MA-NS16	1" Bi-Metal Hole saw
MA-NS18	1-1/8" Bi-Metal Hole saw
MA-NS22	1-3/8" Bi-Metal Hole saw
MA-NS24	1-1/2" Bi-Metal Hole saw
MA-NS26	1-5/8" Bi-Metal Hole saw
MA-NS28	1-3/4" Bi-Metal Hole saw
MA-NS32	2" Bi-Metal Hole saw
MA-NS36	2-1/4" Bi-Metal Hole saw
MA-NS40	2-1/2" Bi-Metal Hole saw
MA-NSPD1	1/4" x 4" Pilot Drill

AIR DUCT CALCULATOR & REFRIGERANT CALCULATOR

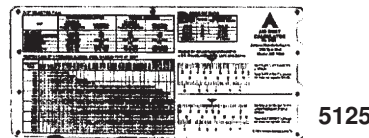

5125 Air duct calculator. Handy size calculator uses only three sides to give all information needed when figuring duct size.

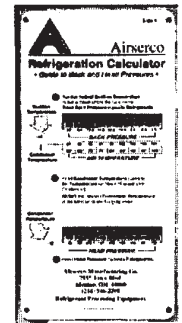

5300 Refrigerant calculator. Graphically shows vital refrigerant data and other service information. Recently updated with data on the new refrigerants.

Part	Description
5125	Air duct calculator
5300	Refrigeration calculator

THE SIDEKICK A CONDENSER CLEANING BREAKTHROUGH!

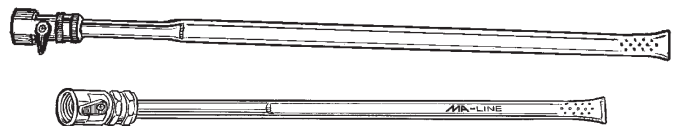

The MA-Line Sidekick is a rugged commercial quality 9" & 30" long American made tool. It is precision formed and machined of thick wall aluminum tubing, with a flow control on-off valve, and comes with a one-year warranty. It is the only tool that is designed and patented (U.S. #4,600,153 and Canada #1257456) specifically to clean air conditioning condensing units. It is a unique power sprayer that simply attaches to a regular garden hose and develops more than four times the cleaning power of a standard nozzle because of its 13 parallel jet streams of water. It delivers a powerful, accurate, but gentle flow that easily flushes lint, hair, dirt, grass clippings, cottonwood fuzzies, and other impurities from the coil.

Part	Description
MA-0210	9" Long Sidekick
MA-0230	30" Long Sidekick

BITS - SLOTTED-PHILLIPS - ROBERTSON - TORQ - SAFETY TORQ

MAGNETIC CHUCKS

Part Description
FOR ELECTRIC DRILLS & POWER SCREWDRIVERS

- MA03539-2 1/4"
- MA03540-2 5/16"
- MA03541-2 3/8"

MAGNETIC CHUCK SETS (Price per Set)

- MA09353-2 1/4", 5/16"
- MA09354-2 1/4", 5/16", 3/8"

FOR ELECTRIC DRILLS & POWER SCREWDRIVERS

- MA03544-2 1/4" x 2-9/16"
- MA03545-2 5/16" x 2-9/16"
- MA03546-2 3/8" x 2-9/16"



MAGNETIC CHUCKS

ON 24-PIECE
 POINT OF PURCHASE
 DISPLAY CARD

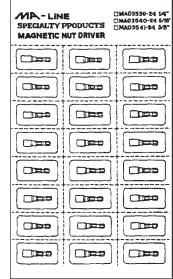

- Part Description
- MA03539-24 1/4" hex opening, 1-5/8" in length
 - MA03540-24 5/16" hex opening, 1-5/8" in length
 - MA03541-24 3/8" hex opening, 1-5/8" in length

**SLOTTED
 1/4" HEX INSERT**

Part Description Pack Qty

1" LENGTH

- MA-9601 1/8" 3
- MA-9602 3/16" 3
- MA-9603 7/32" 3
- MA-9604 9/32" 3

2" LENGTH

- MA-9605 3/16" 2
- MA-9606 7/32" 2
- MA-9607 9/32" 2

2-3/4" LENGTH

- MA-9608 3/16" 2
- MA-9609 7/32" 2
- MA-9610 9/32" 2

ASSORTMENT PACK, 2" LENGTH 3 PER PACK

- MA03542-2 3/16, 7/32, 9/32

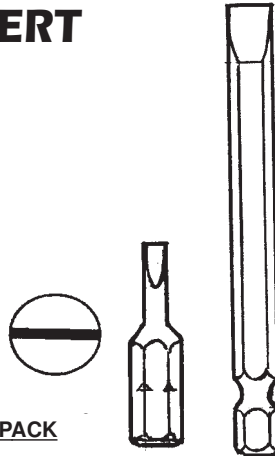

**TORQ/TAMPER PROOF
 1/4" HEX INSERT**

Part Description Pack Qty

1" LENGTH

- MA-9634 T-10 3
- MA-9635 T-15 3
- MA-9636 T-20 3
- MA-9637 T-25 3
- MA-9638 T-30 3
- MA-9639 T-40 3

2" LENGTH

- MA-9640 T-10 2
- MA-9641 T-15 2
- MA-9642 T-20 2
- MA-9643 T-25 2
- MA-9644 T-30 2
- MA-9645 T-40 2

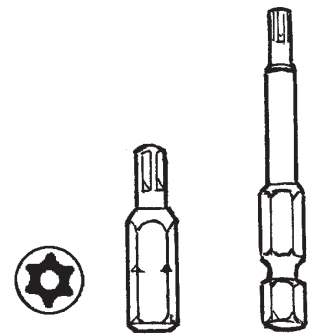

PHILLIPS 1/4" HEX INSERT

Part Description Pack Qty

1" LENGTH

- MA-9611 0 pt. 3
- MA-9612 1 pt. 3
- MA-9613 2 pt. 3
- MA-9614 3 pt. 3

2" LENGTH

- MA-9615 0 pt. 2
- MA-9616 1 pt. 2
- MA-9617 2 pt. 2
- MA-9618 3 pt. 2

2-3/4" LENGTH

- MA-9619 1 pt. 2
- MA-9620 2 pt. 2
- MA-9621 3 pt. 2

ASSORTMENT PACK, 2" LENGTH

- MA03543-2 1,2,3 3

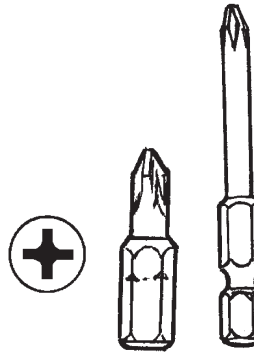

POZIDRIVE 1/4" HEX INSERT

Part Description Pack Qty

1" LENGTH

- MA-9646 1 pt. 3
- MA-9647 2 pt. 3

2" LENGTH

- MA-9648 1 pt. 2
- MA-9649 2 pt. 2

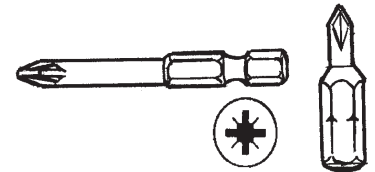

**ROBERTSON
 1/4" HEX
 INSERT**

Part Description Pack Qty

1" LENGTH

- MA-9650 1/16" 3
- MA-9651 3/32" 3
- MA-9652 1/8" 3
- MA-9653 9/64" 3

2" LENGTH

- MA-9654 1/16" 2
- MA-9655 3/32" 2
- MA-9656 1/8" 2
- MA-9657 9/64" 2

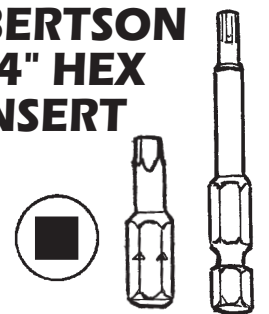

TORQ 1/4" HEX INSERT

Part Description Pack Qty

1" LENGTH

- MA-9622 T-10 3
- MA-9623 T-15 3
- MA-9624 T-20 3
- MA-9625 T-25 3
- MA-9626 T-30 3
- MA-9627 T-40 3

2" LENGTH

- MA-9628 T-10 2
- MA-9629 T-15 2
- MA-9630 T-20 2
- MA-9631 T-25 2
- MA-9632 T-30 2
- MA-9633 T-40 2

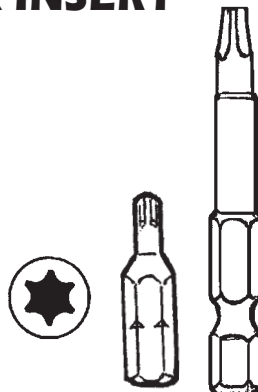

DOUBLEWAY

Part Description Pack Qty

2" LENGTH

- MA-9658 1x4mm 2
- MA-9659 2x5mm 2
- MA-9660 2.5.5mm 2
- MA-9661 3x6mm 2



**MAGNETIC BIT HOLDER
 1/4" HEX DRIVE**

1" LENGTH; 1 PER PACKAGE

- MA-9662 2-1/2" Long
- MA-9663 3" Long



Part Description Pack Qty

- MA-9664 1/4" x 1/4" 1
- MA-9665 1/4" x 3/8" 1



6-IN-1 SCREWDRIVER

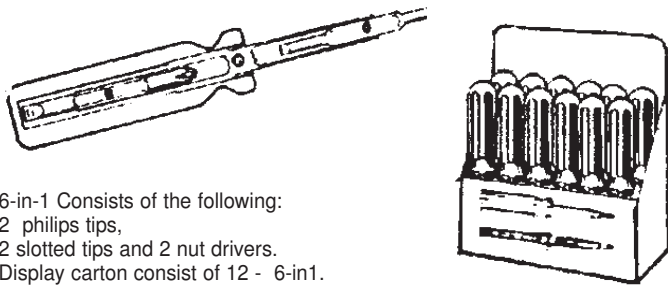

6-in-1 Consists of the following:
 2 phillips tips,
 2 slotted tips and 2 nut drivers.
 Display carton consist of 12 - 6-in-1.

Part	Description
MA-9357	6-in-1
REPLACEMENT TIPS	
MA-SDB2	Large & Small slotted tip
MA-SDB8	Large & Small phillips tip

HEAVY DUTY RUBBER GRIP 6-IN-1 SCREWDRIVER

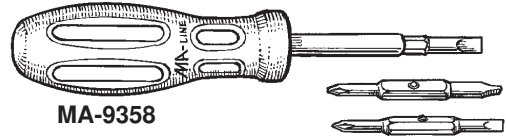

MA-9358

6-in-1 screwdriver has two Phillips heads and two slotted heads and 2 nut drivers. Has a comfortable heavy duty grip.

Part	Description
MA-9358	6-in-1 Screwdriver

QUICK CHANGE ADAPTOR KIT

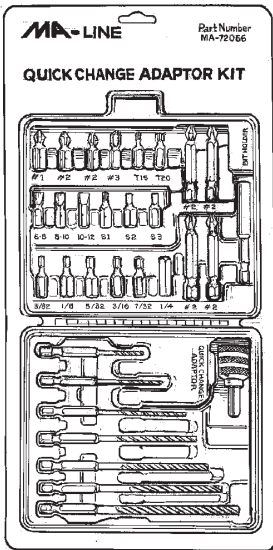

MA-72066

- Kit includes:
- 1 Quick Change Adaptor
 - 1 Bit Holder
 - 4 Phillips Bits 1-#1, 2-#2, 1-#3, 1" Long
 - 3 Slotted Bits 1- 6-8, 1-8-10, 1-10-12, 1" Long
 - 2 Torx Bits 1-T15, 1-T20, 1" Long
 - 3 Square Head Bits 1-S1, 1-S2, 1-S3, 1" Long
 - 5 Hex Head Bits 3/32", 1/8", 5/32", 3/16", 7/32", 1" Long
 - 7 Drill Bits 1/16", 3/32", 1/8", 5/32", 3/16", 7/32", 1/4"
 - 1 Hex Extension 1" Long
 - 4 Phillips Bits #2, 2" Long
 - 24 Assorted Bits,
 - Plastic Case

FOR REPLACEMENT PARTS, REFER TO PAGE 24

Part	Description
MA-72066	Adaptor Kit

MULTI-BIT & DRIVER KIT

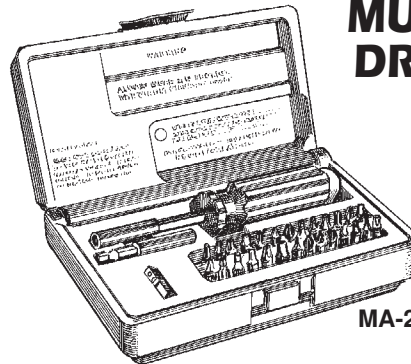

MA-290

29 Piece Tool Kit Assorted Bits with Driver & Extension

Part	Description
MA-290	Multi-Bit and Driver Kit

QUICK CHANGE DRILL ADAPTER

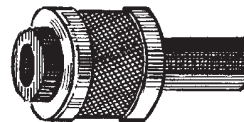

MA03500-2

Part	Description
MA03500-2	Quick change drill adapter for 1/4" hex shank

QUICK CHANGE CHUCK DRILL BITS

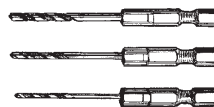

Part	Description	Qty/Pack
MA03505-2	1/16" drill bit hex shank	1
MA03506-2	3/32" drill bit hex shank	1
MA03507-2	1/8" drill bit hex shank	1
MA03508-2	5/32" drill bit hex shank	1
MA03509-2	3/16" drill bit hex shank	1
MA03510-2	1/4" drill bit hex shank	1

TWIST DRILL SETS AND HIGH SPEED STEEL TWIST DRILLS JOBBERS LENGTH

AVAILABLE IN ASSORTED SETS OR INDIVIDUAL SIZES



Part	Description
MA-147B	13 piece drill set 1/16"-1/4" in round plastic case
MA-145D	29 piece drill set 1/16"- 1/2" in metal case
MA-147C	21 piece drill set 1/16"-3/8" in round plastic case

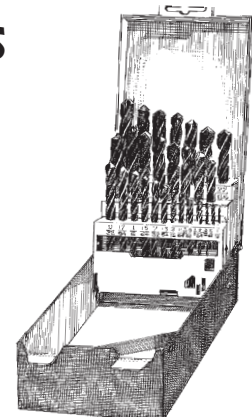

CRIMPING TOOL MULTI-PURPOSE WIRING TOOL / DELUXE WIRE STRIPPER

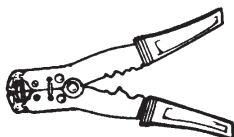

MA03203-2



MA03200-2

Part	Description
MA03200-2	Crimping Tool
MA03203-2	Deluxe Wire Stripper & Cutter

PLIERS / WRENCHES



MA-442G



MA-424G

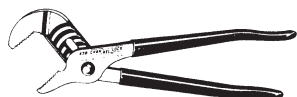

MA-420G MA-440G
MA-426G MA-460G



MA-GL12



MA-460G



MA-326



MA-317G

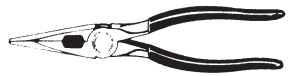

MA-318



MA-337
MA-338



MA-348



MA-926



MA-909



MA-806 MA-810
MA-808 MA-812

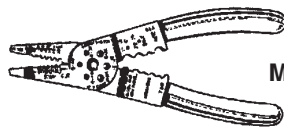

MA-908G

TONGUE AND GROOVE PLIERS

Part	Description	Capacity
MA-424G	4-1/2" Tongue and Groove	1/2"
MA-420G	9-1/2" Tongue and Groove	1-1/2"
MA-422G	9-1/2" V-Jaw Tongue & Groove	1-1/2"
MA-426G	6-1/2" Tongue and Groove	7/8"
MA-430G	10" Tongue and Groove	2"
MA-GL10	10" Griplock Tongue and Groove	1-1/4"
MA-440G	12" Tongue and Groove	2-1/4"
MA-442G	12" V-Jaw Tongue and Groove	2-1/4"
MA-460G	16" Curved Jaw Tongue and Groove	4-14"

STANDARD PATTERN PLIERS

Part	Description
MA-326	6" Long Nose Pliers
MA-317G	7-1/2" Long Nose Pliers with side cutters
MA-318	8" Heavy Duty Long Nose Pliers with side cutters
MA-337	7" Lap Joint Diagonal
MA-338	8" Lap Joint Diagonal
MA-348	8-1/2" Lineman's Bevel Nose Pliers
MA-909	Crimping Tool

ADJUSTABLE WRENCHES

Part	Description	Capacity
MA-806	6" Adjustable Wrench	3/4"
MA-808	8" Adjustable Wrench	1-5/16"
MA-810	10" Adjustable Wrench	1-1/8"
MA-812	12" Adjustable Wrench	1-5/16"

CONVERTIBLE SNAP RING PLIER

Part	Description
MA-926	Convertible Snap Ring Plier

WIRE CUTTER

Part	Description
MA-908G	Wire Cutter

WISE-GRIP® LOCKING HAND TOOLS

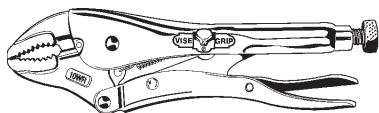

MA-7CR
MA-10CR

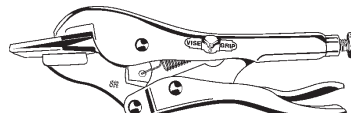

MA-8R

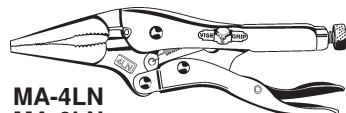

MA-4LN
MA-6LN
MA-9LN

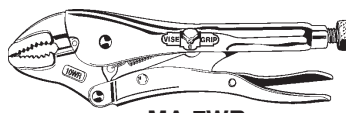

MA-7WR
MA-10WR

Part	Description
MA-1RR	Locking Pinch-Off Tool
MA-QP400	"Quick-Pierce" Refrigerant Recovery Tool
MA-4LN	4" Long nose lock pliers with cutter
MA-6LN	6" Long nose locking pliers with wire cutter
MA-7CR	7" Curved jaw locking pliers
MA-7WR	7" Curved jaw locking pliers with wire cutter
MA-8R	8" Sheet metal pliers
MA-9LN	9" Long nose locking pliers with wire cutter
MA-10CR	10" Curved jaw locking pliers
MA-10WR	10" Curved jaw locking pliers with wire cutter



MA-1RR

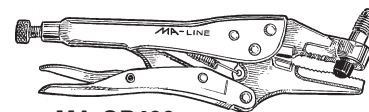

MA-QP400

SERVICE WRENCHES STRAIGHT

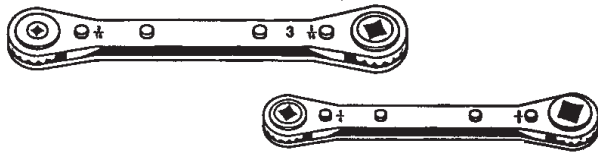

Standard reversible ratchet wrench with square openings is 1/4" and 3/16" at one end, and 3/8" and 5/16" at the other.

Part	Description
MA-60613	Service Straight Wrench
MA-60613-25	25 Service Straight Wrenches (bulk box of 25)

HEX KEY ADAPTER

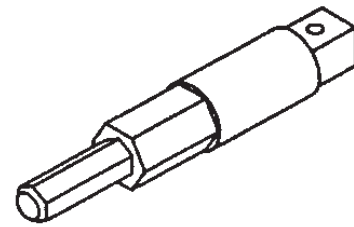

Part	Description
MA-60609	Hex Key Adapter
MA-60610	Hex Key Adapter and Service Wrench, Straight (MA-60613)

OFFSET WRENCH



Knuckle saver design for convenience in tight areas. Square opening is 1/4" and 3/16" at one end, and 3/8" and 5/16" at the other.

Part	Description
MA-60616	Offset Wrench
MA-60616-25	25 Offset Wrenches (bulk box of 25)

PIPE WRENCHES

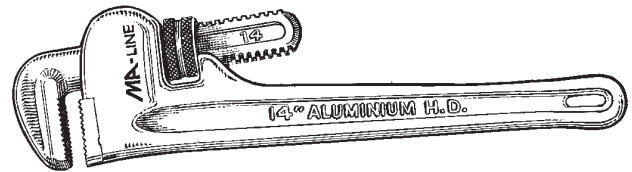

STEEL PIPE WRENCHES

Part	Description
MA-70090	8" Heavy duty pipe wrench
MA-70091	10" Heavy duty pipe wrench
MA-70093	14" Heavy duty pipe wrench
MA-70094	18" Heavy duty pipe wrench
MA-70095	24" Heavy duty pipe wrench

ALUMINUM PIPE WRENCHES

Part	Description
MA-70097	12" Aluminum pipe wrench
MA-70098	14" Aluminum pipe wrench
MA-70099	18" Aluminum pipe wrench
MA-70100	24" Aluminum pipe wrench

PLIERS PLUS

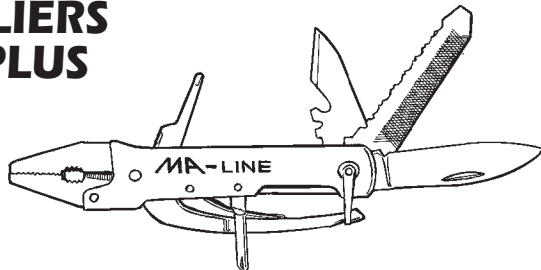

This multifunctional tool from the MA-Line is made of surgical stainless steel. It has pliers, wire cutters, wire stripper, both Phillips and flat screwdrivers, a file, a mini-saw and several other useful tools. It also comes with a nylon carrying case that easily attaches to your belt.

Part	Description
MA-MT53	Pliers Plus/with case

FLARE NUT WRENCHES

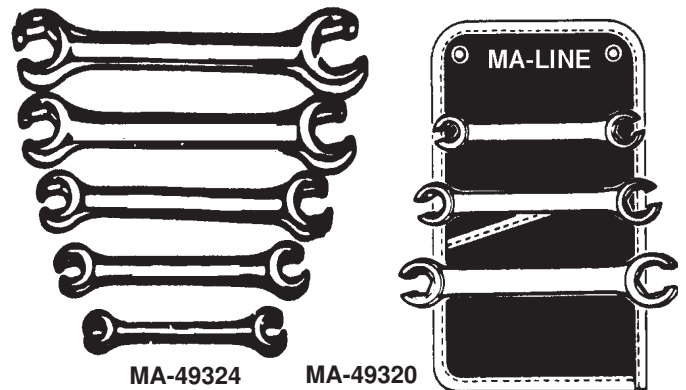

Part	Description
MA-49320	3 pc Flare Nut Set 3/8 x 7/16", 1/2 x 9/16", 5/8 x 11/16"
MA-49324	5 pc Flare Nut Set 1/4 x 5/16", 3/8 x 7/16", 1/2 x 9/16", 5/8 x 11/16", 3/4 x 7/8"

Replacement Wrenches

MA-49330	1/4" X 5/16"
MA-49331	3/8" X 7/16"
MA-49332	1/2" X 9/16"
MA-49333	5/8" X 11/16"
MA-49334	3/4" X 7/8"

MINI POCKET MULTI-TOOL

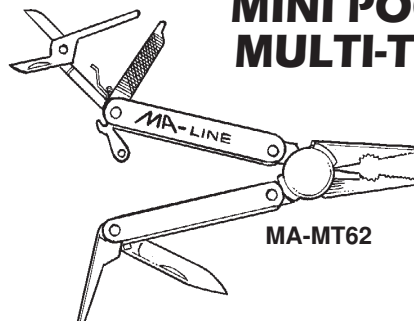

Part	Description
MA-MT62	Mini-Pocket Multi-Tool

STAINLESS STEEL POCKET KNIVES

DELUXE STAINLESS STEEL POCKET KNIVES. LOCK BACK ACTION WITH SAFETY LOCK.

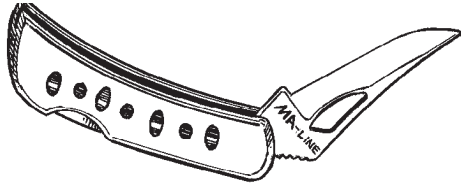

Part
MA-KVS007
Description
Pocket Knife
2" Blade, 3" Closed

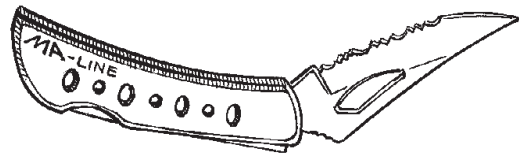

Part
MA-KVS008
Description
Knife—2" Blade,
3" Closed, Serrated Blade

DUCTBOARD KNIFE & SHEATH STAINLESS STEEL

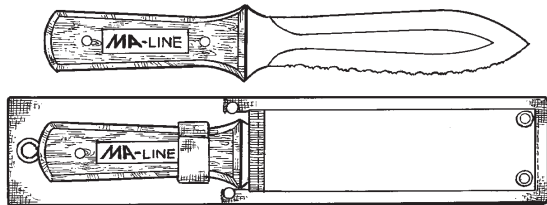

2-Sided Blade • 1 Side Smooth and 1 Side Serrated

Part
MA-KN74HD
Description
Ductboard Knife

DUCTBOARD KNIFE & SHEATH BLADE LENGTH — 6"



Part
MA-KN73
MA-SH73
MA-SHKN73
Description
Ductboard Knife
Ductboard Knife Sheath
Sheath and Knife Sheath

UTILITY CUTTERS



Part
MA-202
MA-202RB
Description
Deluxe Cutter with pocket Clip
Replacement Blades for
(10 per case)

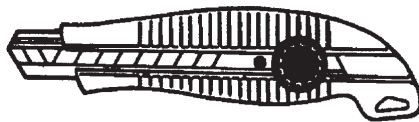

Part
MA-301
MA-301RB
Description
Heavy Duty Cutter
Replacement Blades for MA-301
(10 per case)

SURGICAL STAINLESS STEEL POCKET KNIVES

WITH HARDWOOD HANDLE, LOCK BACK ACTION
WITH SAFETY LOCK

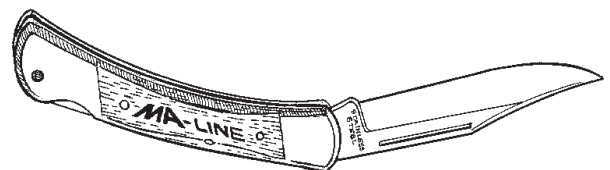

Part
MA-KC710
Description
Knife
3 3/4" Blade, 5" Closed—Complete with Pouch

KNIFE SHARPENER

One sharpener that will give these
knives and tools a razor edge.
Serrated, filet, paring, pocket,
hunting knives—axes, shovels,
hatchets & other tools.

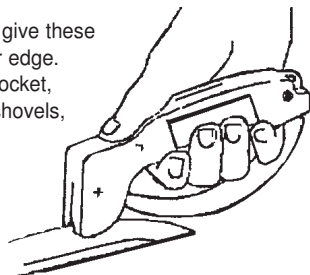

Part
MA-KSS1
Description
Knife and Tool Sharpener

SCISSORS SHARPENER

Works great on
• Household scissors
• Hedge clippers
• Tin snips

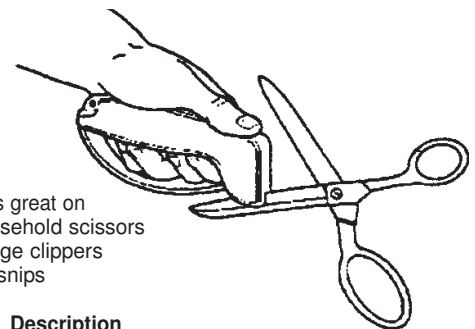

Part
MA-ST5
Description
Scissors and Tin Snip Sharpener

TELESCOPING GLASS MIRRORS

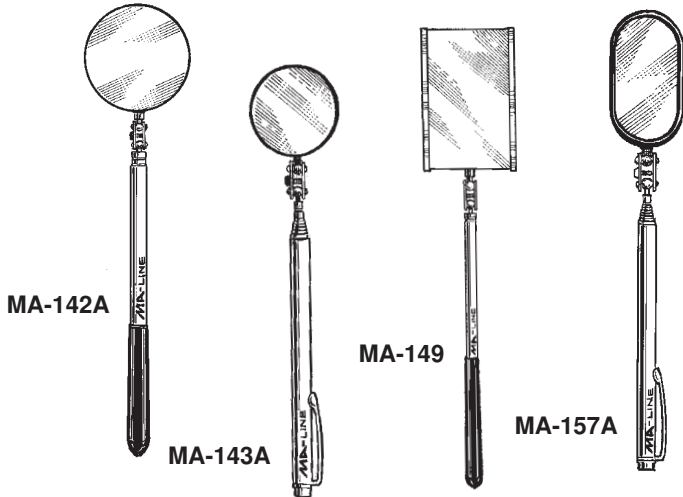

Part	Description
MA-142A	2-1/4" Diameter Round Mirror Telescopic handle from 9-1/4" to 14-1/4".
MA-142MA	2-1/4" Diameter Round Head Magnified Inspection Mirror. Telescopic handle from 9-1/4" to 14-1/4".
MA-143A	1-1/4" Round Inspection Mirror Telescopic from 7" to 19". With pocket clip and insulated head.
MA-143M	1-1/4" Round Inspection Mirror. Telescopic from 7" to 19" magnified. With pocket clip and insulated head.
MA-149	2-1/8" x 3-1/2" Rectangular Mirror Telescopic handle from 11" to 15-1/2"
MA-157A	1" x 2" Oval Mirror Telescopic from 7" to 19". With pocket clip and insulated head.

STAINLESS STEEL MIRRORS TELESCOPING

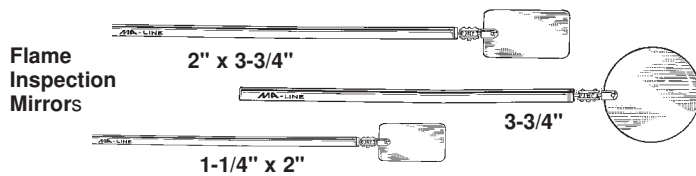

Part	Description
MA-SM6	Small Rectangle Stainless Mirror
MA-SM7	Large Rectangle Stainless Mirror
MA-SM8	Round Stainless Mirror

REPLACEMENT GLASS



Part	Description
MA-142-1	Replacement Mirror Only 2-1/4" Round Glass Mirror
MA-149-1	Replacement Mirror Only 2-1/8" x 3-1/2"
MA-157-1	Replacement Mirror Only 1" to 2" Oval Glass Mirror

POCKET LEVELS

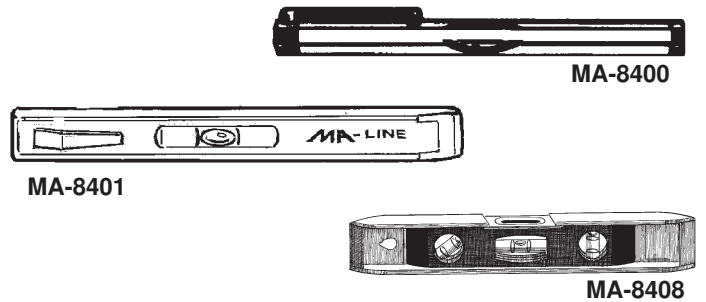

Part	Description
MA-8400	Aluminum pocket level 5" long, easy to read
MA-8401	Plastic pocket level; 5" long
MA-8408	MAGNETIC PVC 9" long level

SPECIALTY TOOLS / PICK UP TOOLS / SCRIBE

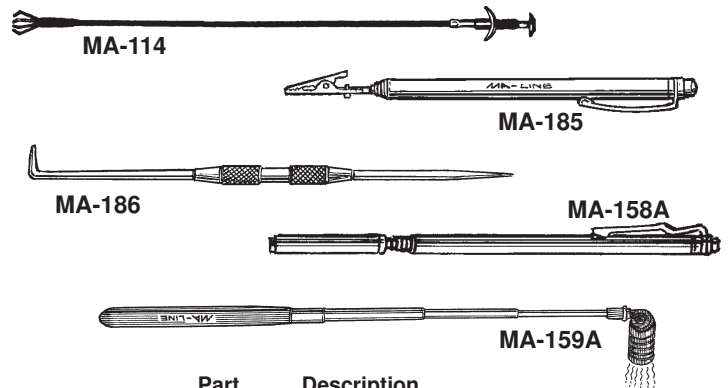

Part	Description
MA-114	Flexible Mechanical fingers, Pick up tool. 17-1/2" long
MA-158A	Telescopic magnet pick up tool. Extends from 5-1/4" to 17-1/4" Chrome plated brass
MA-159A	Deluxe Magnetic Pick up Tool With Swivel Head, Pick up to 10 lbs., stainless steel shaft, Extends up to 32", Non-slip cushion grip
MA-186	Scribe (dual end)
MA-185	Telescopic furnace lighter

SCREWSTARTERS 3" TO 9" LENGTHS

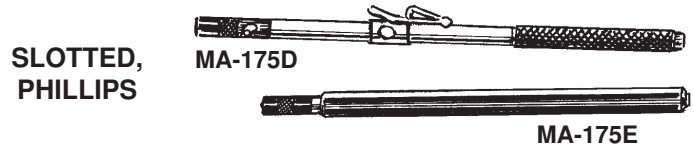

Part	Description
MA-174	Screw Starter Slotted Head 3" Aluminum Handle with Magnet
MA-174D	Screw Starter Phillips Head 3" Aluminum Handle with Magnet
MA-171	Screw Starter Phillips Head 6" Nylon Handle with Magnet
MA-175D	Screw Starter Phillips Head 6" Aluminum Handle with Magnet
MA-175E	Screw Starter Slotted Head 6" Nylon Handle with Magnet
MA-176E	Screw Starter Slotted Head 9" Nylon Handle with Magnet

SHOP WIPES



75 towels per container. Dries fast, no need for water. Safe for the skin. Comparable to other hand cleaner towels.

Part	Description	ctn	qty
MA-SW70C-6	Shop Wipes	6	

WORK BELTS

FEATURES:

- Mesh Back Support Belt
- 8" Wide Mesh back panel
- 5" Wide elastic bands for proper fit.
- 1 1/4" Wide elastic adjustable suspenders.
- 4 Internal stays keep belt from rolling.

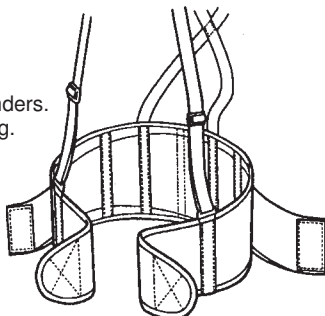

5400S	Fits waist sizes 26" - 33"
5400M	Fits waist sizes 32" - 38"
5400L	Fits waist sizes 37" - 43"
5400XL	Fits waist sizes 41" - 49"

Part	Description
MA-5400S	BACBELT with suspenders Size S, Replaces MA-5900S
MA-5400M	BACBELT with suspenders Size M, Replaces MA-5900M
MA-5400L	BACBELT with suspenders Size L, Replaces MA-5900L
MA-5400XL	BACBELT with suspenders Size XL, Replaces MA-5900XL

SHOP TOWELS

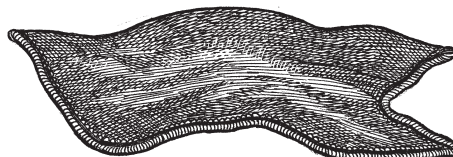

Part	Description
MA-33350	Blue Kimtex Towel, 180 per box
MA-33570	Blue Kimtex Towel, 100 per box
MA-34790	Teri-Wipes, 125 per box
MA-41300	Workhorse Heavy-duty, 150 per box

COTTON SHOP TOWELS (RAGS)

MA-XL80-4	Cotton Shop Towel, 4 per bag
MA-XL80-25	Cotton Shop Towels, 25 per bag

NON-TOXIC PARTICLE AND DUST MASK



(Nuisance dust mask only. Offers no respiratory protection.)

50 Masks per Box

Part	Description
MA-7300	Non-Toxic Dust Mask Replaces MA-8500

COVERALLS AND BOOT/SHOE COVERS

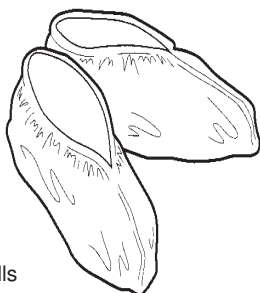

Part	Description
MA-36732	Large (42-44) Hooded Coveralls with attached hood, white
MA-36742	X-Large (46-50) Hooded Coveralls with attached hood, white
MA-73532	Shoe Covers - Blue Size Universal, fits sizes 6-12 150 pair/Case Replaces Part # MA-36885

BLUE NITRILE DISPOSABLE POWDERED GLOVES

The new MA-Line Nitrile disposable gloves have superior softness and comfort. They are resistant to abrasion, punctures and chemical deterioration, and are 100% nitrile-hypoallergenic. Wrist length fit is almost like a second skin. Cooler than rubber latex because they relax and conform to your hand. Three sizes available: Medium, Large, and Extra-Large

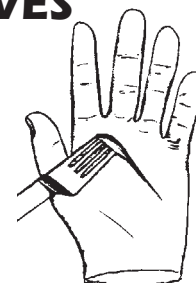

100 Gloves per Box

Part	Description
MA-8646M	Medium, Replaces MA-7005M
MA-8646L	Large, Replaces MA-7005L
MA-8646XL	Extra Large, Replaces MA-7005XL

GLOVES

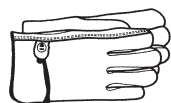

MA-1132L

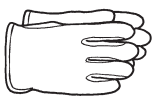

MA-2149L

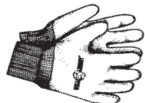

MA-190



MA-192

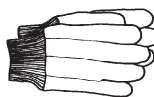

MA-302L



MA-5027



MA-167L



MA-48L

Part	Description
MA-48L	8 oz. White cotton canvas with navy knit wrist
MA-167L	PVC vinyl outer shell with cotton fleece lining. Extra long 14" gauntlet cuff and textured. Rough finish for excellent wet grip. Chemical resistant. Liquidproof. Replaces MA-187
MA-190	Black Neoprene coating over 100% cotton backing. Chemical, fuel & oil resistant. Liquidproof.
MA-192	Same as MA-190 but has 12" gauntlet cuff instead of blue knit wrist.

Part	Description
MA-302L	9 oz. brown cotton. Hob-Nob plastic dots on palm, thumb and forefinger for better grip.
MA-1132L	Adjustable ball and strap fastener. Grain leather gloves. (Use where extra durability & hand protection are important.)
MA-2149L	100% brown cotton jersey outer fabric bonded to red fleece cotton lining. Side opening. Bunn cut.
MA-5027	Leather palm and thumb. Knit wrist.

ASSORTED RUBBER STRAPS

Package includes:
2-10" 3-15" 3-20" 2-31"



Part	Description
MA-76110	Assorted Rubber straps

RUBBER STRAPS



The "EPDM Rubber Tie Down" rubber is oil, ozone and chemical resistant. It will not fade in ultraviolet light and can be used in temperatures ranging from 20°F to 120°F.

Part	Description
MA-1109	10" Rubber strap maximum safe stretch 15"
MA-1115	15" Rubber strap maximum safe stretch 22"
MA-1122	20" Rubber strap maximum safe stretch 32"
MA-1131	31" Rubber strap maximum safe stretch 46"
MA-1141	41" Rubber strap maximum safe stretch 62"

NYLON STRAPS



Part	Description	MA-RS300
MA-S30	30" Nylon strap	
MA-S60	60" Nylon strap	
MA-S144	144" Nylon strap	
MA-RS300	15' Ratcheting Nylon tie down strap	

POLYPROPYLENE ROPE



3 strand monofilament high quality 100% twisted monofilament polypropylene has more strength. Twice the strength of manila rope. Resistant to rot, abrasion, petroleum products, marine growth and most chemicals. Floats.

Color: Yellow
1/4" Dia. Tensile Strength 1250 lbs.
3/8" Dia. Tensile Strength 2700 lbs.

Part	Description
MA-0360	1/4" x 50' Polypropylene Rope
MA-0361	1/4" x 100' Polypropylene Rope
MA-0362	3/8" x 50' Polypropylene Rope
MA-0363	3/8" x 100' Polypropylene Rope

FORM HOLDERS CLIPBOARDS

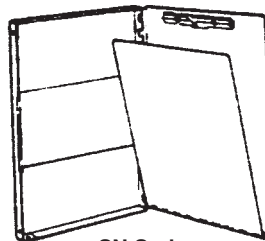

SN Series

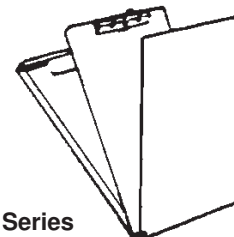

AH Series

AH-Series: Versatile, efficient and easy to use. Accommodates forms ruled lengthwise or across the width. Plate folds under copies to provide hard, smooth writing surface. Holds up to 30 completed forms. The aluminum cover sports a powerful, easy to use clip, holding approximately 1/2" of forms and doubles as a clipboard.

SN Series: Accommodates loose forms, sets, or sales books. Hinged aluminum strap holds copies securely in place, and the entire holder folds into a compact protective box to keep forms safe.

Part	Description	Qty
MA-AH4295	4-1/4" x 9-1/2" Clipboard	12
MA-AH5795	5-2/3" x 9-1/2" Clipboard	12
MA-AH8512	8-1/2" x 12" Clipboard	12
MA-SN5795	5-2/3" x 9-1/2" Clipboard	12
MA-SN8512	8-1/2" x 12" Clipboard	12
MA-SN8514	8-1/2" x 14" Clipboard	6

MODERN REFRIGERATION AND AIR CONDITIONING

HARD COVER LATEST EDITION!

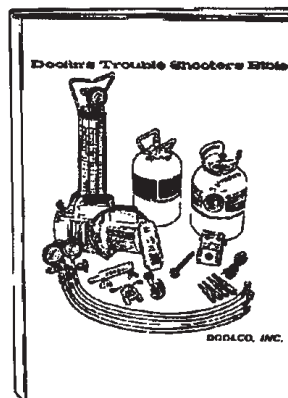

Doolin's Trouble Shooters Bible
MA-345-1

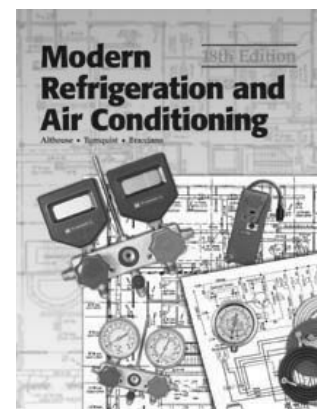

MA-340-5

Part	Description
MA-340-5	Modern Refrigeration and Air Conditioning / Hard Cover
MA-345-1	Doolin's Trouble Shooters Bible English Edition, Hard Cover
MA-345-2	Doolin's Bible Spanish Edition, Hard Cover

MAX-FLOW™ COMBINATION OIL PUMP

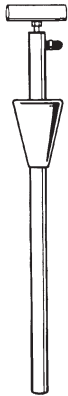

FEATURES:

- Suction transfer hose included
- Connects to bottom of unit to pump oil from equipment quickly and efficiently
- Remove oil for recovery and conversion
- Add oil to existing systems

Part	Description
MA-77940	Combination Oil Pump

GASKET MATERIAL

NON ASBESTOS
12" X 40" SHEETS

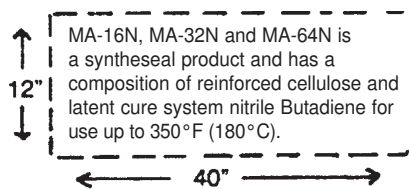

Part	Description
MA-16N	1/6"
MA-32N	1/32"
MA-64N	1/64"
MA-16RR	1/16" Temp -20°F to 120°F Red rubber 24" x 36", Smooth finish

GASKET SCRAPER

Hard edge may be resharpened.
Scrape surfaces before installing new gaskets.



Part	Description
MA-72433	Gasket Scraper

PUTTY KNIFE

Semi-Flexible Blade
Angled for edge work, great for light scraping.

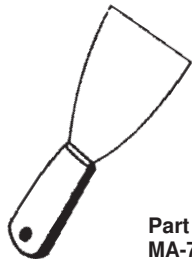

Part	Description
MA-72435	Putty Knife 1-1/4"
MA-72437	Putty Knife 3"

1-1/4" CHISEL SCRAPER

Heavy duty, compact size. Can be resharpened many times.
Tough, durable, long lasting.

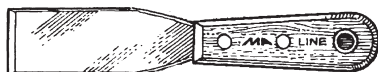

Part	Description
MA-72439	Chisel Scraper

GREASE, GREASE GUNS, FITTINGS TOOLS AND ACCESSORIES

GREASE HOSE

- MA-10214
- MA-10218

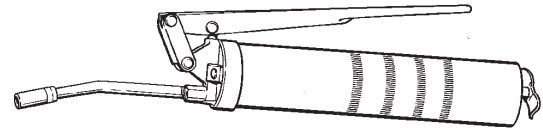

MA-30200



MA-11315

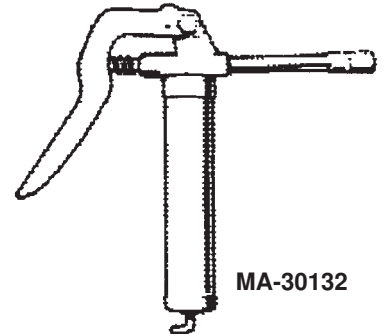

MA-30132

COUPLER
MA-05028



Part Description GREASE & GREASE GUNS

MA-11315	Multi-purpose 14 oz cartridge (10 per case) Sold by the case only
MA-11302	Multi-Purpose Grease (3.5oz. Cartridge—2 per bag)
MA-11354	White Lithium Grease 14 oz cartridge (10 per case) Sold by the case only
MA-30132	Mini-Grease Gun Kit
MA-30200	Heavy Duty Grease Gun

GREASE FITTINGS & ACCESSORIES

MA-05028	Coupler
MA-10214	12" Grease Hose
MA-10218	18" Grease Hose

COMPRESSOR MOUNTING GROMMETS & SLEEVES

Sold 4 per package

Part	Compressor/Tonnage
MA-9001	1 to 5 ton
MA-9002	7-1/2 to 10 ton
MA-9003	12 to 24 ton

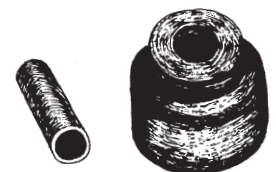

SNIPS

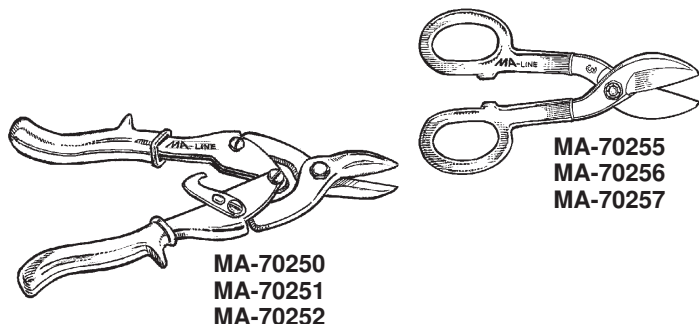

MA-70250
MA-70251
MA-70252

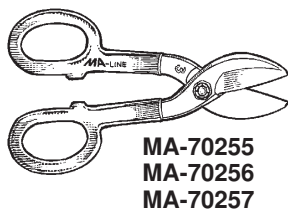

MA-70255
MA-70256
MA-70257

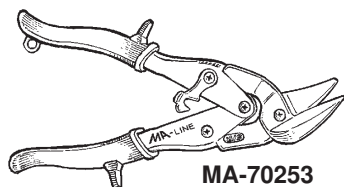

MA-70253
MA-70254

AVIATION SNIPS

These new 10" aviation snips from MA-Line meet Federal specifications ANSI/ASME B107-16-1985. They have blades that are made from drop-forged AISI-6150 chrome vanadium steel, with serrated blade edges that have been induction hardened. They are rated to cut up to 1.2 mm cold rolled steel, or .7 mm AISI-304 stainless steel.

Part	Description
MA-70250	Cuts Left (Red)
MA-70251	Cuts Right (Green)
MA-70252	Cuts Straight (Yellow)

OFFSET SNIPS

Vinyl plastic handle guard grips. Offset blades keep hand above metal, eliminate interference with metal being cut. Cuts up to 1-1/2".

MA-70253	Cuts Left
MA-70254	Cuts Right

TINNER SNIPS

Straight pattern recommended when a powerful snip and a straight is desired. Polished blades and baked enamel handles.

MA-70255	7" Long, Cuts 1-3/4"
MA-70256	10" Long, cuts 2-1/2"
MA-70257	12-1/2" Long, Cuts 3"

TAPE MEASURES

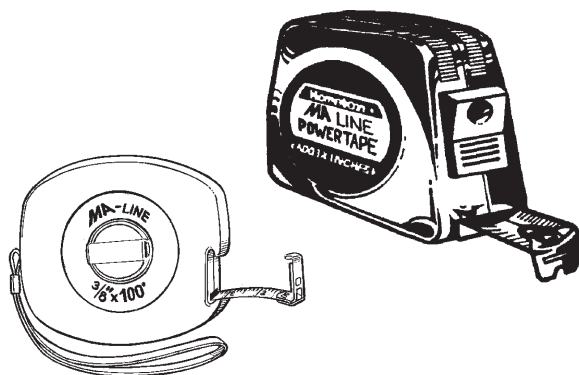

READS IN FEET AND METRIC MEASUREMENTS

Part	Description
MA0126-12	1/2" x 12' Tape Measure w/lock
MA0128-25	1" x 25' Tape measure w/lock
MA0129-30	1" x 30' Tape Measure w/ lock
MA0130-50	3/8" x 50' Reel Tape
MA0131-100	3/8" x 100' Reel Tape

HACKSAWS AND BLADES

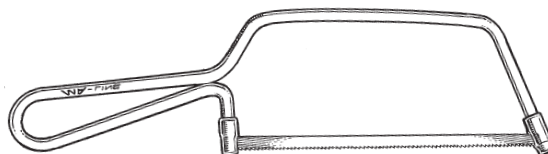

MA-70-14JR

MA-70-14JR	Junior Hacksaw with Blade	
MA-71-132R	Blade only for MA-70-14JR	10/pkg

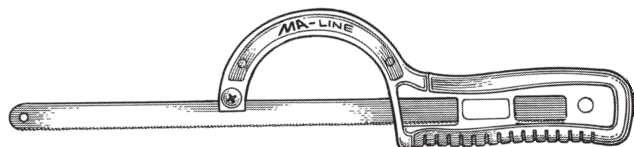

MA-132A

Part	Description
MA-132A	Mini-Hacksaw with blade

Replacement Hacksaw Blades

Part	Description	Pkg.
MA-AA45E	12" Hacksaw Blade (18TPI)	10/pkg
MA-AA46V	12" Hacksaw Blade (24TPI)	10/pkg
MA-AA47R	12" Hacksaw Blade (32 TPI)	10/pkg

STEEL CALIPER



MA-71801P

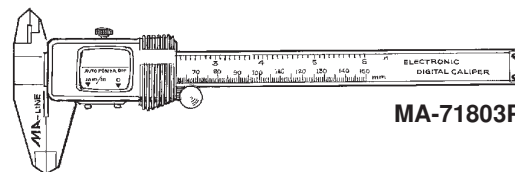

MA-71803P

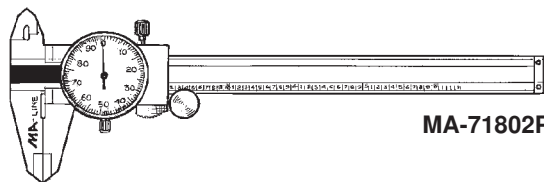

MA-71802P

The new, inexpensive, and easy-to-use caliper from the Ma-Line is made of all steel. Designed to measure in both inches and centimeters. Hand to measure thickness or gauge of any type of metal, as well as the ID or the OD of tubing or fittings.

Part	Description
MA-71801P	Steel Caliper

Deluxe Digital Electronic Caliper represents the latest in technology at an economical price level. Unit will measure in standard inches or metric. Comes with a deluxe storage case for protection of this valuable instrument. The LED display is designed to measure at the speed of 60"/second or 1.5M/second. Also has a serial output for interface with a host computer or printer.

Part	Description
MA-71803P	Deluxe Digital Caliper

Shockproof unit measures in standard or metric and comes with a deluxe storage case. All stainless steel construction is warranted for one year from date of purchase.

Part	Description
MA-71802P	6" Dial Caliper

ANTI-VIBRATION PADS

To prolong machine life, reduce maintenance cost and dampen vibration. Resists: water, aging, oil & compression set.

Recommended maximum load capacity: 50 pounds per square inch.

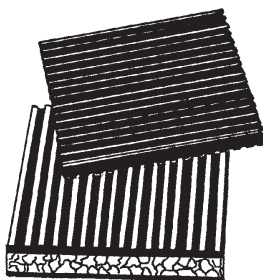

Part	Description	Ctn
CORK & RUBBER PADS		
MA-002CR	2" x 2" x 7/8" Cork/Rubber	48
MA-003CR	3" x 3" x 7/8" Cork/Rubber	36
MA-004CR	4" x 4" x 7/8" Cork/Rubber	24
MA-006CR	6" x 6" x 7/8" Cork/Rubber	24
MA-012CR	12" x 12" x 7/8" Cork/Rubber	6
MA-018CR	18" x 18" x 7/8" Cork/Rubber	6

ALL RUBBER PADS

MA-002RR	2" x 2" x 3/8" All Rubber	48
MA-003RR	3" x 3" x 3/8" All Rubber	36
MA-004RR	4" x 4" x 3/8" All Rubber	24
MA-006RR	6" x 6" x 3/8" All Rubber	24
MA-012RR	12" x 12" x 3/8" All Rubber	12
MA-018RR	18" x 18" x 3/8" All Rubber	6

FLEXIBLE GAS CONNECTORS AGA & CGA CERTIFIED



COATED STAINLESS STEEL

Description: An indoor/outdoor gas connector for **Residential and Commercial gas appliances**, not subject to frequent movement. Operating Temperature: -40 deg to 150 deg. CSA-approved for indoor and outdoor use. **Polymer coating** resists sea salt, UV rays, harsh chemical residue and building products such as solder flux, muriatic acid, ammonia and chlorine.

3/8" I.D. TUBE

Part	Description	Length
MA-CSSD54-12	1/2" FIP x 1/2" MIP	12" long
MA-CSSD54-18	1/2" FIP x 1/2" MIP	18" long
MA-CSSD54-24	1/2" FIP x 1/2" MIP	24" long
MA-CSSD54-36	1/2" FIP x 1/2" MIP	36" long
MA-CSSD54-48	1/2" FIP x 1/2" MIP	48" long
MA-CSSD54-60	1/2" FIP x 1/2" MIP	60" long
MA-CSSD54-72	1/2" FIP x 1/2" MIP	72" long

1/2" I.D. TUBE

Part	Description	Length
MA-CSSC21-12	3/4" FIP x 3/4" MIP	12" long
MA-CSSC21-18	3/4" FIP x 3/4" MIP	18" long
MA-CSSC21-24	3/4" FIP x 3/4" MIP	24" long
MA-CSSC21-36	3/4" FIP x 3/4" MIP	36" long
MA-CSSC21-48	3/4" FIP x 3/4" MIP	48" long
MA-CSSC21-60	3/4" FIP x 3/4" MIP	60" long
MA-CSSC21-72	3/4" FIP x 3/4" MIP	72" long

1/2" I.D. TUBE

Part	Description	Length
MA-CSSC54-12	1/2" FIP x 1/2" MIP	12" long
MA-CSSC54-18	1/2" FIP x 1/2" MIP	18" long
MA-CSSC54-24	1/2" FIP x 1/2" MIP	24" long
MA-CSSC54-36	1/2" FIP x 1/2" MIP	36" long
MA-CSSC54-48	1/2" FIP x 1/2" MIP	48" long
MA-CSSC54-60	1/2" FIP x 1/2" MIP	60" long
MA-CSSC54-72	1/2" FIP x 1/2" MIP	72" long

NATURAL RUBBER VIBRATION PADS MOUNTING PADS

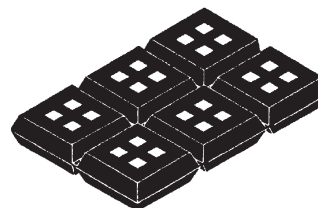

Part	Description	Sheets/Ctn	Sq/Sheet
MA-181838	18" x 18" x 3/8" Pad	12	81
MA-181834	18" x 18" x 3/4" Pad	6	81

GAS BALL VALVES

ALL MODELS HAVE AGA, CGA, UL AND CSA APPROVALS

Lever handle forged brass ball valves. Standard port, full port 600PSI, W.O.G., 150 PSI saturated steam.

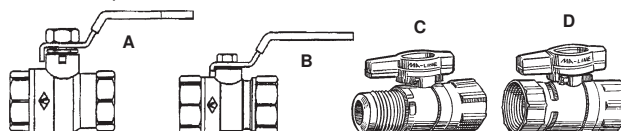

Part	Description
MA-73101	1/2" OD x 1/2" FPT Straight (C)
MA-73102	5/8" OD Flare x 3/4" FPT (C)
MA-73105	3/8" FPT x 3/8" FPT (D)
MA-73103	1/2" FPT x 1/2" FPT (D)
MA-73104	3/4" FPT x 3/4" FPT (D)
MA-73106	1" FPT x 1" FPT (D)
MA-73107	1-1/4" FPT x 1-1/4" FPT Standard Port (B)
MA-73108	1-1/2" FPT x 1-1/2" FPT Standard Port (B)
MA-73109	2" FPT x 2" FPT Standard Port (B)
MA-73110	1-1/4" FPT x 1-1/4" FPT Full Port (A)
MA-73111	1-1/2" FPT x 1-1/2" FPT Full Port (A)
MA-73112	2" FPT x 2" FPT Full Port (A)

MAXICAP COVERS

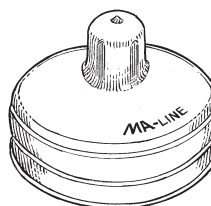

MAXICAP3R, MAXICAP5R

Put the lid on call-backs. Not only does the Maxicap prevent regulator lockup due to ice and snow blockage of the vent, it also prevents insects or buildups of mud and debris from clogging the vent. Black in color.

FEATURES:

- Inexpensive and effective
- Maintains vent limit protection
- Simple installation
- No tools required
- UV Safe
- Patent pending

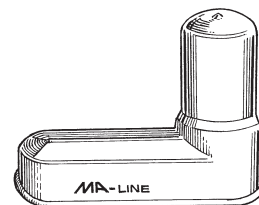

MAXICAP7R

Part	Description
MAXICAP3R	Rubber Weather Cover Fits Maxitrol 325-3 Series Regulator
MAXICAP5R	Rubber Weather Cover Fits Maxitrol 325-5 Series Regulators
MAXICAP7R	Rubber Weather Cover Fits Maxitrol 325-7 and 210D Series Regulators

HEATING SYSTEM BOILER GAUGES

For domestic boilers to indicate the operating conditions existing within hot water heating systems.

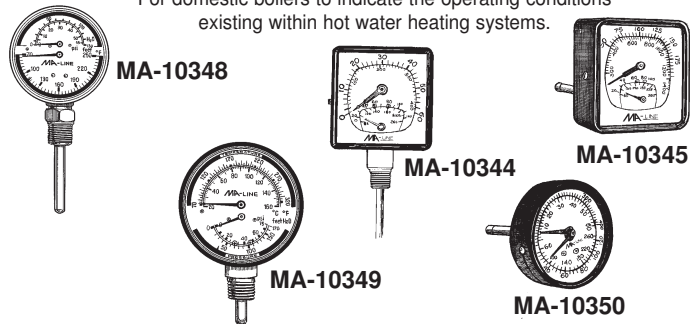

Part	Description
MA-10344	1/2" N.P.T. 0-75 PSI Bottom mount / 4" square 60°F to 260°F, (20°C to 120°C)
MA-10345	1/2" N.P.T. 0-75 PSI Back mount / 4" square 60°F to 260°F, (20°C to 120°C)
MA-10346	1/2" N.P.T. 0-200 PSI Bottom mount / 4" square 60°F to 260°F, (20°C to 120°C)
MA-10347	1/2" N.P.T. 0-200 PSI Back mount / 4" square 60°F to 260°F, (20°C to 120°C)
MA-10348	1/2" N.P.T. 0-55 PSI Bottom mount / 3" round, 0-125 feet H ₂ O, 70°F to 250°F, (20°C to 120°C) 2" Stem
MA-10349	1/2" N.P.T. 0-75 PSI Bottom mount / 3" round, 0-170 feet H ₂ O, 70°F to 320°F, (20°C to 160°C), 3/4" Stem
MA-10350	1/4" N.P.T. 0-75 PSI Back mount / 2-1/2" round 60°F to 320°F, (20°C to 160°C)

NEOPRENE AIR TUBING

ROUND AND SQUARE

For use on furnaces, boilers, ventor motors, air duct pressure switches and rooftop pressure differential switches.



SPECIFICATIONS:

Inside Diameter: 1/8" ID and 3/16" ID
Pressure: -20 to + 20" WC.
Temperature Rating: 0° to 160°F.

Part	Description	Pkg./Qty.
MA-NAT18-5	1/8" ID Air Tubing	5' Rolls
MA-NAT316-5	3/16" ID Air Tubing	5' Rolls
MA-NAT316	3/16" ID Air Tubing	100' Rolls

SQUARE BLACK NEOPRENE TUBING

Specifications:
Temperature Range: -20F to 212F (-28C to 100C)

Part	Description	Pkg./Qty
MA-SNAT316-5	3/16" ID x 8mm Square Neoprene Tubing	5' Roll

SILICONE RUBBER TUBING

(RED)

Specifications:
Silicone Rubber Tubing, NSF 51 Soft, Red
Temperature Range: -100F to 500F (-73C to 260C)



Part	Description	Pkg./Qty
MA-SRT18-5	1/8" ID x 5/16" OD Red Silicone Tubing Working 25 PSI, Burst 75 PSI	5' Roll
MA-SRT316-5	3/16" ID x 5/16" OD Red Silicone Tubing Working 20 PSI, Burst 60 PSI	5' Roll
MA-SRT14-5	1/4" ID x 3/8" OD Red Silicone Tubing Working 5 PSI, Burst 15 PSI	5' Roll

3/4" PRESSURE TEST GAUGE USED TO TEST GAS LINE PRESSURE

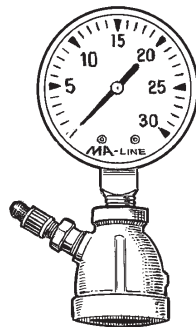

Part	Pipe Size	Pressure Range
MA-17255	3/4"	0-15#
MA-17256	3/4"	0-30#
MA-17257	3/4"	0-100#

ALUMINUM TUBING KITS 5' COILS

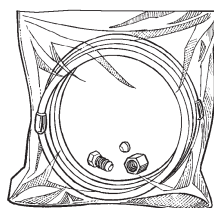

SPECIFICATIONS:

ASTM B491
1435 Alloy
.035 Wall Thickness
Temperature Range (°F) -250°F to 250°F

COMPLETE KIT INCLUDES
5' ALUMINUM COIL,
1 BRASS BREAKAWAY FITTING,
1 BRASS SLEEVE AND
1 BRASS COMPRESSION NUT.

MA-LINE COIL KIT WITH 5' ALUMINUM TUBING AND BRASS FITTINGS

Part	Description
MA-AT18-5	1/8" Aluminum tubing (5' coil)
MA-AT316-5	3/16" Aluminum tubing (5' coil)
MA-AT14-5	1/4" Aluminum tubing (5' coil)
MA-AT38-5	3/8" Aluminum tubing (5' coil)

50' COILS ALUMINUM TUBING

(Wall Thickness .035)

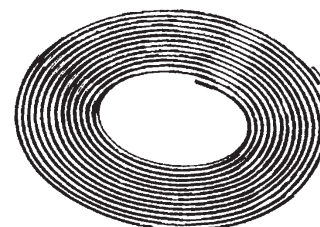

Part	Description
MA-AT18	1/8" OD Aluminum tubing
MA-AT316	3/16" OD Aluminum tubing
MA-AT14	1/4" OD Aluminum tubing
MA-AT516	5/16" OD Aluminum tubing
MA-AT38	3/8" OD Aluminum tubing
MA-AT716	7/16" OD Aluminum tubing
MA-AT12	1/2" OD Aluminum tubing
MA-AT58	5/8" OD Aluminum tubing

SPECIFICATIONS:
ASTM B491
1435 Alloy
.035 Wall Thickness
Temperature Range (°F)
-250°F to 250°F

PILOT LIGHT (BREAKAWAY) FITTINGS

Nut with break-Away sleeve. Screws into gas control valves for furnaces, water heaters, etc. Sold individually

Part	Description
181SP-02	1/8" Pilot Fittings
181SP-03	3/16" Pilot Fittings
181SP-04	1/4" Pilot Fittings
181SP-06	3/8" Pilot Fittings



REFRACTOMETERS

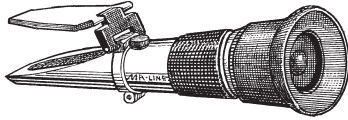

Make sure you get consistent, accurate mineral oil readings every time you change refrigerants with the MA-REF700 Oil Refractometer.

The handheld refractometer is an easy-to-use instrument that accurately measure the mineral oil in a polyolester (POE) lubricant.

Every service contractor should have one.

SPECIFICATIONS:

Range 1.435-1.520nD (with 3 Scales)

This companion unit to the MA-Line oil refractometer (MA-REF700) is a precision optical instrument designed to measure the freezing point of ethylene or propylene based cooling systems. The two Fahrenheit non-linear scales cover -60°F to +32°F for ethylene glycol and propylene glycol.

The resolution of the temperature scale is 10°F.

A Celsius reading model is also available (MA-REF401C).

Part	Description
MA-REF700	Oil Refractometer Replaces MA-REF505RI
MA-REF401F	Glycol Fahrenheit
MA-REF401C	Glycol Celsius

HAND-HELD SCALES

CAPACITY: 0 TO 50 LBS.

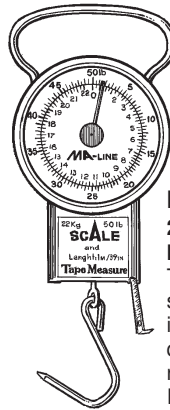

- FEATURES:** MA-49051
- 0 to 50 lbs. scale
 - Memory at maximum weight
 - Auto shut-off in 50 seconds
 - Accuracy up to ±2%
 - 9V battery included
 - Lbs/Kgs switch

MA-HS50
2 1/2 INCH DIAL - 0 TO 50 LBS.
IN 1/2 LB. INCREMENTS

The MA-Line MA-HS50 hand-held scale is a convenient, lightweight, inexpensive scale designed to be a quick weight reference for refrigerant cylinders.

Its 0 to 50 lb. range is designed in one-half lb. increments, and is capable of replacing the more expensive, but not more accurate units in the field today.

Part	Description
MA-49051	Digital Scale
MA-HS50	Scale & Tape Measure

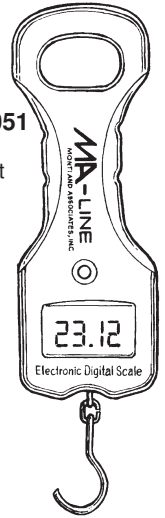

MA-LINE DIGITAL SCALE

CAPACITY: 0 TO 260 LBS.

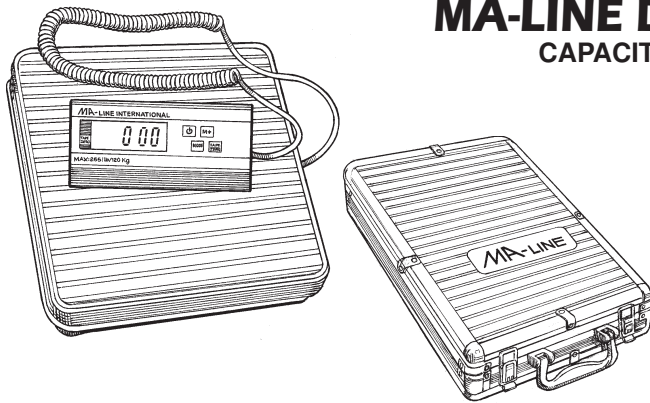

FEATURES:

- Capacity: 0 to 260 lbs. (0/120kg)
- Graduation: 0.01 oz. (0.05kg)
- Measures: Pounds, Kilograms and Pound/Ounces
- Auto Power off
- AC Power (AC adapter included) (1-9V battery included)
- Power Supply: 110V, 60Hz/220V, 50Hz
- Platform Size: 10" x 10", (254mm x 254mm) with rubber pad
- Carrying case included

Part	Description
MA-49052A	Digital Scale with Carrying Case
MA-49052EPC	EU Style Power Cord

DIGITAL & MECHANICAL SCALES

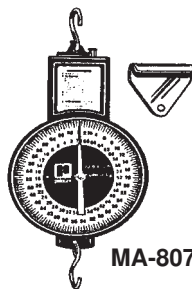

MA-8070

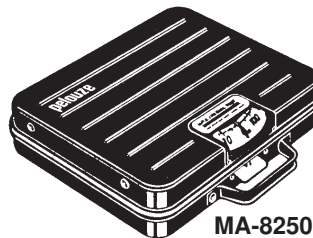

MA-8250

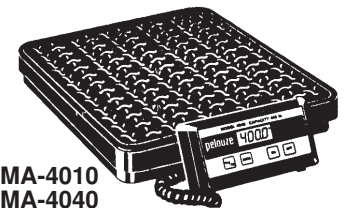

MA-4010
MA-4040

Part	Description
MA-8070	Hanging Utility Scale; 1/4 lb x 70 lb. with suspension accessory, Micro-adjustment Dual markings (red/recapturing, black/filling), adjustable tare pointer, and top and bottom "S" hooks (Pelouze D70)
MA-8250	Heavy Duty Utility Scale; 1 lb. x 250 lb. with "memory lock". Recessed carrying handle, upright storage, large numerals, adjustment knob. (Pelouze P250S) 1lb. Graduation
MA-4010	Heavy Duty Digital Scale; 1/2 lb. x 125 lb. with detachable control panel/9 ft. cord. Operates on an A/C adaptor (included), or 1 9-volt battery (not included). Auto calibration, LCD digital display, recessed carrying handle, rust and chemical resistant ABS. (Pelouze 4010) 0.2 lb./60kg x 0.1 Graduation
MA-4040	Heavy Duty Digital Scale; 1/2 lb. x 400 lb. detachable, wall mounted control panel, 6 ft. cord & LCD display. Operates on an AC adaptor (included), or a 9-volt battery (not included). Steel construction, strain gauge weighing and tare. 12" x 12-1/2" x 2-1/4". (Pelouze 4040) 1/2 lb./0.2 kg Graduation

2 SPEED-HEAT SHRINK-HEAT GUN

**MA02525-3
MA02525-EUKIT**

Kit includes:
Heat gun, scraper,
3 different scraper styles and
4 different blower nozzles.

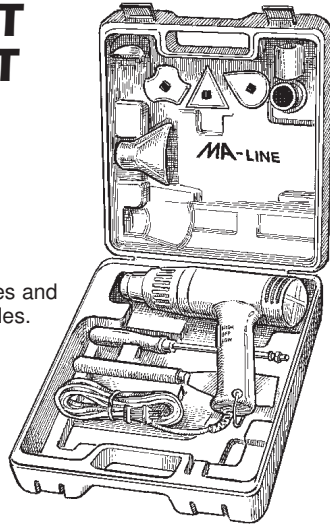

MA02525-2
Lightweight, versatile, flameless heat.
On-off switch, 2-speed, 1500 watts.
High speed 1100 ° F.
Low speed 600° F.

Part	Description
MA02525-2	115V, 60 HZ Heat Gun only, North American plug, UL Listed, CSA and R0HS Compliant
MA02525-3	115V, 60 HZ Heat Gun Kit, North American plug, UL Listed, CSA and R0HS Compliant
MA02525-EUKIT	230V, 50 HZ Heat Gun Kit, w ith European Continental Plug, CE Approved and R0HS Compliant

CRANKCASE HEATERS

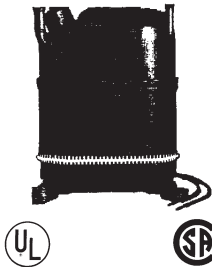

Part	Description	Girth Dimensions		
		Min.	Max.	Shape
MA-CH100	240V, 50 Watt	30-3/16	37	Oval
MA-CH101	240V, 54 Watt	27-1/16	34-1/4	Oval
MA-CH101-1	208V, 54 Watt	27-7/16	34-1/4	Oval
MA-CH101-2	120V, 54 Watt	27-1/16	34-1/4	Oval
MA-CH101-3	480V, 54 Watt	27-7/16	34-1/4	Oval
MA-CH102	240V, 60 Watt	25-3/4	32-9/16	Oval
MA-CH102-1	208V, 60 Watt	25-3/4	32-9/16	Oval
MA-CH102-2	120V, 60 Watt	25-3/4	32-9/16	Oval
MA-CH103	240V, 45 Watt	24-3/4	31-9/16	Oval
MA-CH103-2	120V, 45 Watt	24-3/4	31-9/16	Oval
MA-CH135	240V, 45 Watt	28-3/16	35-5/8	Oval

REFRIGERANT RECOVERY CYLINDERS

The MA-Line refrigerant recovery cylinders are U.S. made and rated for 400#. Each cylinder is equipped with a liquid/vapor "Y" valve and 3/4" plugged opening. Other size recovery cylinders are available upon request, as well as acetylene, oxygen, and nitrogen cylinders. All cylinders can be combined with other MA-Line products to reach a freight prepaid status.

REFRIGERANT RECOVERY CYLINDERS FOR R410A REFRIGERANT, 400# RATED

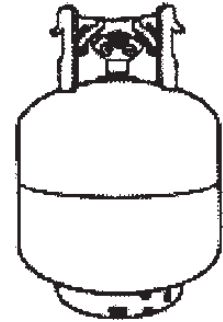

Part	Description
MA-400RC30	30# Recovery Cylinder
MA-400RC50	50# Recovery Cylinder

Y-VALVE FOR 30# & 50# RECOVERY TANK



MA-563211 Y-Valve

REFRIGERANT CYLINDER BAND HEATER



120V, heater draws 200 watts and has 135° preset thermostat
Fits 30 lb., 50 lb., and 125 lb. cylinders

Easy to install and use
Safe, built-in thermostat

Part	Description
3054	Refrigerant cylinder Band Heater

LIQUID LEVEL SWITCHES FOR 30# AND 50# RECOVERY CYLINDERS

These new liquid level switches from the MA-Line have the 80% shut-off feature and are designed to fit the most popular 30# and 50# cylinders available in the market today. Both items have 3-pin Brad Harrison fittings.

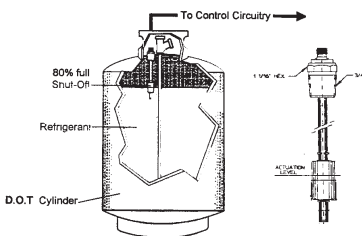

Part	Description
MA-128500	For 30# or 50# Cylinder, 3-pin Brad Harrison Receptacle. Switch Designed for Worthington and Manchester Cylinders Only Refer to OEM list at right
MA-152540	For 26# and 48# Cylinder, 3-pin Brad Harrison Receptacle. Switch Designed for Amtrol Cylinders Only

- OEM LIST:
- Nat'l Refrigeration Products (NRP)
 - Promax n Robinair Thermal Engineering
 - Watsco n Penguin
 - Ridgid (Ridge Tool)
 - Jameskamm (Katy Instruments)

TANKS

MC TANK - ACETYLENE

Part T 019 Description MC Empty New

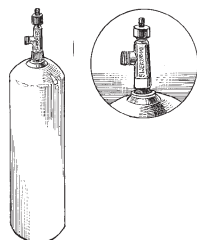

B TANK - ACETYLENE

T 018 B Empty New



OXYGEN TANKS

T 002 20 cu. ft. Empty New
T 003 40 cu. ft. Empty New
T 032 55 cu. ft. Empty New
T 080 80 cu. ft. Empty New

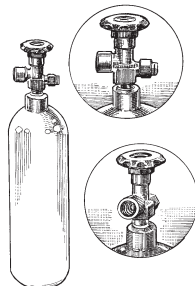

NITROGEN TANKS

T 027 20 cu. ft. Empty New
T 005 40 cu. ft. Empty New
T 076 55 cu. ft. Empty New
T 085 80 cu. ft. Empty New

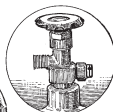

CO₂ CYLINDERS

T 0210 5# Reinspected New Valve, Empty
T 0220 10# Reinspected New Valve, Empty
T 0230 15# Reinspected New Valve, Empty
T 0240 20# Reinspected New Valve, Empty

OTHER SIZES AVAILABLE BY REQUEST

REFRIGERANT RECOVERY CYLINDERS

The MA-Line refrigerant recovery cylinders are U.S. made and rated for 400#. Each cylinder is equipped with a liquid/vapor "Y" valve and 3/4" plugged opening. Other size recovery cylinders are available upon request, as well as acetylene, oxygen, and nitrogen cylinders. All cylinders can be combined with other MA-Line products to reach a freight prepaid status.

REFRIGERANT RECOVERY CYLINDERS FOR R410A REFRIGERANT, 400# RATED

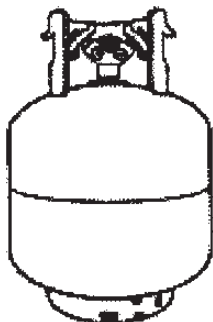

Part MA-400RC30 Description 30# Recovery Cylinder
Part MA-400RC50 Description 50# Recovery Cylinder

BERNZOMATIC SELF IGNITING TORCHES



TS839T

TS4000T

TS7000T

Part	Description
TS4000T	Trigger start cast aluminum Torch Head, Self-igniting. Pull the trigger it's on, release the trigger it's off. Swirl flame with locking button. Pressure regulated for constant performance. Stainless burntube, cast aluminum body and brass burntip. Burns MAPP or propane. Replaces MA-T111 and MA-T501
TS7000T	High output Cast Aluminum Torch Head Heavy Duty Trigger start with Adjustable flame, pull the trigger it' on, release the trigger it' off. Swirl action flame heats up work fast. Pressure regulated, Durable construction. Lock button for continuous operation. Burns MAPP or propane. Replaces MA-T655
TS839T	Swirl Head Brazing Torch—Spark ignition—swivel head with push-button ignitor produces turbocharged flame of 3600°. Swivel head allows flame to be directed in any direction. Burns either MAPP or propane. Replaces MA-SF839TS

FLAME SHIELDS

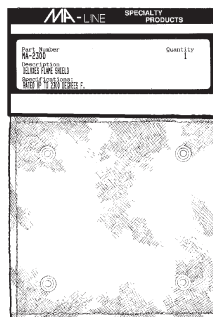

Grommets in each corner for ease of hanging. Measures approximately 11" x 11-1/2"

Specifications:
MA-1500 rated up to 1500° F (850°C)
MA-2300 rated up to 2300° F (1260°C)

Part	Description
MA-1500	Flame Shield to 1500° F (850°C)
MA-2300	Flame Shield to 2300° F (1260°C)

SAND CLOTH & PADS

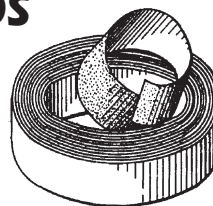

Part	Description
MA-90303	EZ plumbers sand cloth 1-1/2" x 10 yd. roll. Water resistant
MA-90304	EZ plumbers sand cloth 1-1/2" x 25 yd roll. Water resistant
MA-90502	A-180 open mesh plumbers roll 1-1/2" x 5 yd. waterproof
MA-90503	A-180 open mesh plumbers roll 1-1/2" x 10 yd. Waterproof
MA-04625	General purpose abrasive pads for soldering and brazing, 10 pads per box

REFRIGERANT LABELS

4-1/4" X 3-5/8"



10-Pack	Description
MA-SRECT	Evacuation Tag
MA-SR11	OSHA Orange
MA-SR12	Black
MA-SR22	OSHA Safety Green
MA-SR113	OSHA Purple
MA-SR114	Blue
MA-SR134A	Light Blue
MA-SR401A	Coral
MA-SR401B	Dull Aluminum
MA-SR402A	Brass
MA-SR402B	Erin Green
MA-SR404A	Citrus Orange
MA-SR406A	OSHA Blue
MA-SR407C	Light Brown
MA-SR408A	OSHA Purple
MA-SR409A	Desert Beige
MA-SR410A	Burgundy
MA-SR417A	Green
MA-SR500	OSHA Safety Yellow
MA-SR502	Violet
MA-SR507	Teal Blue
MA-SHCFC123	Chrome Aluminum
MA-SAB1	Alkyl Benzene
MA-SMO1	Mineral Oil
MA-SPA1	PAG Oil
MA-SPO1	Polyol Ester

50-Pack	Description
MA-SRECT-50	Evacuation Tag
MA-SR111-50	OSHA Orange
MA-SR12-50	Black
MA-SR22-50	OSHA Safety Green
MA-SR113-50	OSHA Purple
MA-SR114-50	Blue
MA-SR134A-50	Light Blue
MA-SR401A-50	Coral
MA-SR401B-50	Dull Aluminum
MA-SR402A-50	Brass
MA-SR402B-50	Erin Green
MA-SR404A-50	Citrus Orange
MA-SR406A-50	OSHA Blue
MA-SR407C-50	Light Brown
MA-SR408A-50	OSHA Purple
MA-SR409A-50	Desert Beige
MA-SR410A-50	Burgundy
MA-SR417A-50	Green
MA-SR500-50	OSHA Safety Yellow
MA-SR502-50	Violet
MA-SR507-50	Teal Blue
MA-SHCFC123-50	Chrome Aluminum
MA-SAB1-50	Alkyl Benzene
MA-SMO1-50	Mineral Oil
MA-SPA1-50	PAG Oil
MA-SPO1-50	Polyol Ester

SAFE FOR DISPOSAL & EVACUATION CERTIFICATION TAGS



A must for every serviceman who field-services appliances and refrigeration units. Strong adhesive backing won't peel off. Environmental green border. Actual size: 5" x 3-1/2".

Part	Description
MA-SDF1	10 Per Pack
MA-SRECT	Evacuation Tag

REFRIGERANT LABEL ASSORTMENT PACK



MA-SARLP Package of 25 small assorted labels containing, 1 each of the following: SDF1, SRECT, SR11, SR12, SR22, SR113, SR114, SR134A, SR401A, SR401B, SR402A, SR402B, SR404A, SR406A, SR408A, SR409A, SR410A, SR500, SR502, SR507, SHCFC123, SAB1, SMO1, SPA1, SPO1.

MA-ARRLP Package of 10 assorted re-claimed refrigerant labels containing, 2 each of the following: UR11, UR12, UR22, UR500 and UR502.

MA-SPARLP Package of 14 assorted small refrigerant labels containing 2 each of the following: SR11, SR12, SR22, SR134A, SR404A, SR501, and SR507.

RE-CLAIMED REFRIGERANT ID LABELS

10 PACK

Part
MA-UR11
MA-UR12
MA-UR22
MA-UR500
MA-UR502

35 PACK

Part
MA-UR11-35
MA-UR12-35
MA-UR22-35
MA-UR500-35
MA-UR502-35

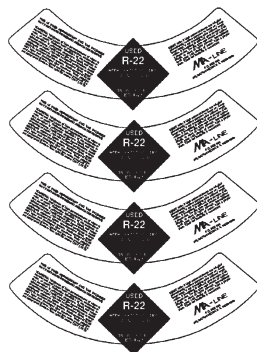

COPPER TUBE BRUSHES

SINGLE SPIRAL—2 ply Wire Construction
Stainless Steel Wire
Solid Plastic Hand-fitting Handle
Copper Tube Fitting Brushes

Part	Description
AMA-824	1/4 OD - 1/8 ID
AMA-825	3/8 OD - 1/4 ID
AMA-826	1/2 OD - 3/8 ID
AMA-827	5/8 OD - 1/2 ID
AMA-828	3/4 OD - 5/8 ID
AMA-829	7/8 OD - 3/4 ID
AMA-830	1 OD - 7/8 ID
AMA-831	1-1/8 OD - 1 ID
AMA-832	1-3/8 OD - 1-1/8 ID
AMA-833	1-1/2 OD - 1-3/8 ID
AMA-834	1-5/8 OD - 1-1/2 ID
AMA-835	2-1/8 OD - 2 ID
AMA-836	2-1/2 OD - 2-1/8 ID



DOUBLE SPIRAL—4 Ply Wire Construction
Solid Plastic Hand-Fitting Construction
Copper Tube Fitting Brushes

Part	Description
AMA-924	1/4 OD - 1/8 ID
AMA-925	3/8 OD - 1/4 ID
AMA-926	1/2 OD - 3/8 ID
AMA-927	5/8 OD - 1/2 ID
AMA-928	3/4 OD - 5/8 ID
AMA-929	7/8 OD - 3/4 ID
AMA-930	1 OD - 7/8 ID
AMA-931	1-1/8 OD - 1 ID
AMA-932	1-3/8 OD - 1-1/8 ID
AMA-933	1-1/2 OD - 1-3/8
AMA-934	1-5/8 OD - 1-1/2 ID
AMA-935	2-1/8 OD - 2 ID
AMA-936	2-1/2 OD - 2-1/8 ID

HOW TO USE

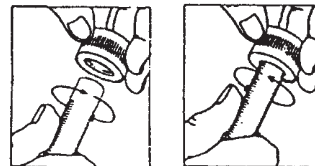

Part	Description
AMA-960	Set of 6—1/4, 3/8, 1/2, 5/8, 3/4, 7/8
AMA-963	1/4 OD - 1/8 ID
AMA-964	3/8 OD - 1/4 ID
AMA-965	1/2 OD - 3/8 ID
AMA-966	5/8 OD - 1/2 ID
AMA-967	3/4 OD - 5/8 ID
AMA-968	7/8 OD - 3/4 ID
AMA-969	1 OD - 7/8 ID
AMA-970	1-1/8 OD - 1 ID

FLUX AND ACID BRUSHES



Flux and Acid Brushes for
Brazeing and Soldering

Tin/Wood Handle

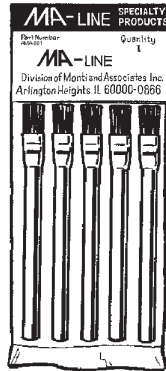

Sold by the Gross Only

Part	Description
AMA-001	Tin Handle 3/8" width
AMA-002	Tin Handle 1/2" width
AMA-003	Tin Handle 5/8" width

Price Each

Part	Description
AMA-007	Wood Handle 3/4" width

Prepackaged Acid Brushes 2

Part	Description	
AMA-001-10	Tin Handle 3/8"	Pack of 10
AMA-002-10	Tin Handle 1/2"	Pack of 10
AMA-003-5	Tin Handle 5/8"	Pack of 5
AMA-007-2	Wood Handle 3/4"	Pack of 2

STAINLESS STEEL WELDER'S "TOOTHBRUSH"



8" OVERALL LENGTH

Part	Description
MA-20534	Stainless Steel Welder's "Toothbrush"

BRASS WELDER'S "TOOTHBRUSH"



7" OVERALL LENGTH

Part	Description
AMA-254	Brass Welder's "Toothbrush"

CONDENSER AND HEAT EXCHANGER BRUSHES

STAINLESS STEEL SINGLE SPIRAL



Part	Description	Female Thread	Brush Length
AMA-502	1/4" Diameter	8-32	3"
AMA-504	3/8" Diameter	12-24	4"
AMA-507	7/16" Diameter	12-24	4"
AMA-510	1/2" Diameter	12-24	4"
AMA-513	9/16" Diameter	12-24	4"
AMA-516	5/8" Diameter	12-24	4"
AMA-519	11/16" Diameter	12-24	4"
AMA-522	3/4" Diameter	12-24	4"
AMA-525	13/16" Diameter	12-24	4"
AMA-528	7/8" Diameter	12-24	4"
AMA-531	15/16" Diameter	12-24	4"
AMA-533	1" Diameter	12-24	4"

BRASS WIRE SINGLE SPIRAL



Part	Description	Female Thread	Brush Length
AMA-602	1/4" Diameter	8-32	3"
AMA-604	3/8" Diameter	12-24	4"
AMA-607	7/16" Diameter	12-24	4"
AMA-610	1/2" Diameter	12-24	4"
AMA-613	9/16" Diameter	12-24	4"
AMA-616	5/8" Diameter	12-24	4"
AMA-619	11/16" Diameter	12-24	4"
AMA-622	3/4" Diameter	12-24	4"
AMA-625	13/16" Diameter	12-24	4"
AMA-628	7/8" Diameter	12-24	4"
AMA-631	15/16" Diameter	12-24	4"
AMA-633	1" Diameter	12-24	4"

BLACK NYLON WIRE SINGLE SPIRAL



Part	Description	Female Thread	Brush Length
AMA-702	1/4" Diameter	8-32	3"
AMA-704	3/8" Diameter	12-24	4"
AMA-707	7/16" Diameter	12-24	4"
AMA-710	1/2" Diameter	12-24	4"
AMA-713	9/16" Diameter	12-24	4"
AMA-716	5/8" Diameter	12-24	4"
AMA-719	11/16" Diameter	12-24	4"
AMA-722	3/4" Diameter	12-24	4"
AMA-725	13/16" Diameter	12-24	4"
AMA-728	7/8" Diameter	12-24	4"
AMA-731	15/16" Diameter	12-24	4"
AMA-733	1" Diameter	12-24	4"

EXTENSION HANDLES & RODS FOR ALL CONDENSER AND HEAT EXCHANGER BRUSHES



Part	Description
AMA-130	4" Handgrip / 12-24 Screw (4" x 1/2" diameter for use with AMA-132 & AMA-133) 6" diameter with d on one end and the other end thru 1" diameter res

4-Foot Extension rod with wire handle .162 diameter -8-32 male thread for use with 1/4" and 5/16" diameter condenser brushes.

Part	Description	Dealer	1-143	144+
AMA-044	4' Extension Rod with Handle for condenser brush.	\$4.39	\$2.99	\$2.85+

FLUE AND FURNACE BRUSHES

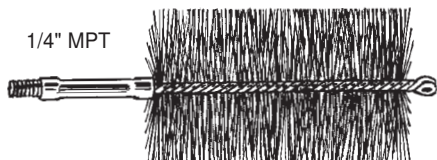

Brush Dimensions
4-1/2" Long

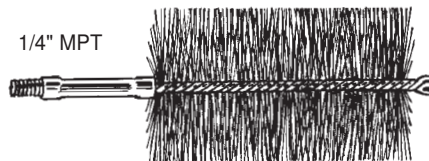

Brush Dimensions
4-1/2" Long

**Round Black Tempered Wire
Single Spiral Threaded Nipples**

Part	Flue Size	Brush Diameter
AMA-206	1"	3/4"
AMA-208	1 1/4"	1"
AMA-212	1 1/2"	1 1/4"
AMA-214	1 3/4"	1 1/2"
AMA-216	2"	1 3/4"
AMA-218	2 1/4"	2"
AMA-222	2 1/2"	2 1/4"
AMA-224	2 3/4"	2 1/2"
AMA-226	3"	2 3/4"
AMA-228	3 1/4"	3"
AMA-232	3 1/2"	3 1/4"
AMA-234	3 3/4"	3 1/2"
AMA-236	4"	3 3/4"

**Round Black Tempered Wire
Double Spiral Threaded Nipples**

Part	Flue Size	Brush Diameter
AMA-306	1"	3/4"
AMA-308	1 1/4"	1"
AMA-312	1 1/2"	1 1/4"
AMA-314	1 3/4"	1 1/2"
AMA-316	2"	1 3/4"
AMA-318	2 1/4"	2"
AMA-322	2 1/2"	2 1/4"
AMA-324	2 3/4"	2 1/2"
AMA-326	3"	2 3/4"
AMA-328	3 1/4"	3"
AMA-332	3 1/2"	3 1/4"
AMA-334	3 3/4"	3 1/2"
AMA-336	4"	3 3/4"

FLUE AND FURNACE BRUSH HANDLES AND EXTENSIONS

SEMI-FLEXIBLE WITH NIPPLE & COUPLING



AMA-438 & AMA-548

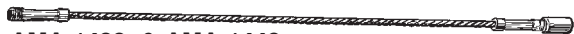

AMA-1438 & AMA-1448

Part	Description
AMA-438	4' Handle 1/4" FPT
AMA-548	5' Handle 1/4" FPT
AMA-1438	4' Extension—1/4" MPT one end / 1/4" FPT other end
AMA-1448	5' Extension—1/4" MPT one end / 1/4" FPT other end

BOILER BRUSH



Part	Description
AMA-406	Extra Long Handle / Stiff Wire Boiler Brush Brush Dimensions: 3/4" W x 4" L, Overall Length 42"

NYLON TUBE BRUSHES



Part	Description
AMA-530	3/4" x 3" Nylon Brush
AMA-539	1" x 4" Nylon Brush
AMA-565	1 1/2" x 4" Nylon Brush
AMA-582	2" x 4" Nylon Brush Overall length 15"

COLUMBIA BOILER BRUSH



Bristles stick out in all directions and are rough cut to a rectangular shape, approximately 1/2" x 1". Much lighter fill than the flat style.

Part	Description
AMA-348	1 1/2" x 1" x 4' Original Columbia Boiler Brush

CLEANING BRUSHES



27"

48"

Part	Description
AMA-762	Cleaning Brush Black Bristle 2"
AMA-763	Cleaning Brush Synthetic Black Horsehair 2-1/2"
AMA-765	Cleaning Horsehair/poly mix Black 2-1/2" Overall brush length is 27" with the actual brush at 7"

Part	Description
AMA-200	Duct/Vent Brush Brass 2-1/8"
AMA-210	Duct/Vent Stainless Steel 2-1/8"
AMA-220	Duct/Vent Black Fiber Brush 2-1/8" Overall brush length is 48" with the actual brush 7"

WIRE BRUSHES

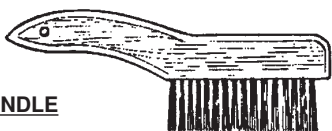

CARBON STEEL CURVED HANDLE

Part Description
AMA-010 14" Hardwood Handle / Tempered Steel Bristles



CARBON STEEL SHOE HANDLE

Part Description
AMA-017 10" Hardwood Handle / Tempered Steel Bristles

STAINLESS STEEL CURVED HANDLE

Part Description
AMA-018 14" Hardwood Handle / Stainless Steel Bristles

VARNISH BRUSH



Part Description
AMA-503 2" Polyester Varnish Brush
AMA-505 3" Polyester Varnish Brush

STAINLESS WIRE BRUSH

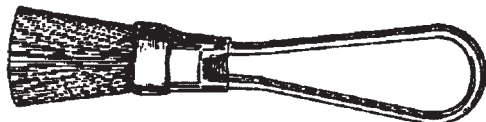

Part Description
AMA-816 Stainless Wire Brush

CONDENSER TUBE BRUSH—SPIN-GRIT™



Spin-Grit™ utilizes the sides of its impregnated nylon filaments to increase the brush's effectiveness!

Brush Dia.	For Cleaning Tube Size
1/2"	1/4" to 5/16"
3/4"	3/8" to 9/16"
1"	5/8" to 11/16"
1-1/4"	3/4" to 1"

- Polish tube interiors without scratching
- Fits all commercial tube cleaners and rods
- Moves through at tube with less effort
- Lasts up to 3 times longer than conventional brushes.

Part	Description	Female Threads
MA-43482	1/2" Brush Diameter	8-32
MA-43484	3/4" Brush Diameter	12-24
MA-43486	1" Brush Diameter	12-24
MA-43488	1-1/4" Brush Diameter	12-24

Part	Description	Male Threads
MA-93482	1/2" Brush Diameter	8-32
MA-93484	3/4" Brush Diameter	1/4-28
MA-93486	1" Brush Diameter	1/4-28
MA-93488	1-1/4" Brush Diameter	1/4-28

NEW PARTS CLEANING BRUSH



Part Description
AMA-015 New Parts Cleaning Brush
 All Poly brush material,
 Overall length 10-3/4"

RADIATOR CLEANING BRUSH



Overall Length 24"
 Brush Length 9"
 Black Horsehair

Part Description
AMA-020 Radiator Cleaning Brush

CONDENSER FIN WHISK BRUSH

Plastic handle whisk for cleaning condenser fins and evaporators.

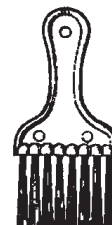

Part Description
AMA-026 Condenser Fin Whisk Brush

OIL OR CHIP BRUSH



Part Description
AMA-481 Oil or Chip Brush

REFRIGERATOR COIL CLEANING BRUSH



Brush Length 15"
 Wood Handle—12" long
 Overall Length 28"

Part Description
AMA-405 Refrigerator Coil Cleaning Brush

CLOTHES DRYER VENT BRUSH WITH 10' FLEXIBLE HANDLE

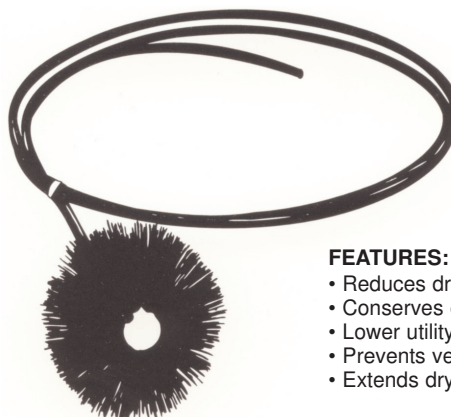

FEATURES:

- Reduces drying time
- Conserves energy
- Lower utility bills
- Prevents vent fires
- Extends dryer life

Part Description
AMA-410 Clothes Dryer Vent Brush with 10' Flexible Handle

GRILL CLEANING BRUSH WITH SCRAPER

STAINLESS STEEL BRISTLES
RUBBER GRIP

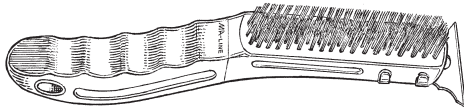

Part	Description
MA-46810	Grill Cleaning Brush

BUCKETS & BUCKET ORGANIZERS

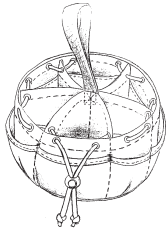

MA-1148
22 POCKET DRAWSTRING BUCKETBAG™
6 Large compartments for organizing small parts. 16 Pockets outside for a variety of tools and accessories. Easy-lock/pushbutton-release drawstring system. Soft bottom panel prevents tipping and spilling 10" Round x 6" High.

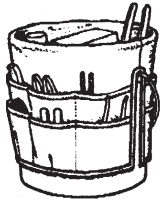
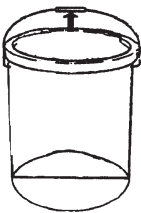

MA-1117
30 POCKET BUCKET POCKETS
16 Multi-size pockets inside and 14 outside to organize a wide range of tools and accessories. Designed to fit most standard 3 1/2 to 5 gallon buckets. Heavy duty stitching and bar tacking at all stress points. (Bucket not included.)

Part	Description
MA-5GP	5 Gallon Buckets
MA-1117	Heavy duty bucket pockets
MA-1148	BucketBag™

PLASTIC TOOL & TOTE CASES

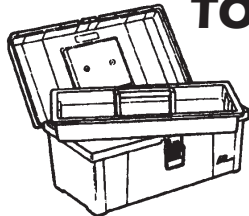

MA-303
Tool Box with Lift Out Tray
Convenient lift out tray. Handles both large & small tools & full size hammer.

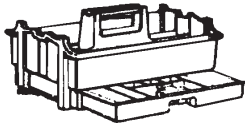

MA-311
Tote-More Tool Box
Convenient handle for portability. Open top for easy access. Multi-compartment drawer for added storage.

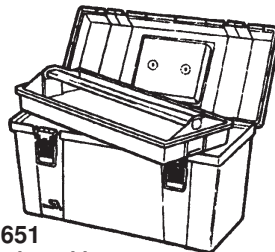

MA-651
20-inch tool box.
Super deep bottom storage. Large box with pull-out tub.

Part	Description
MA-303	Tool box with lift out tray 15 3/8"L x 7 3/4"W x 5 1/4" H
MA-311	Tote-more tool box 14 3/4"L x 8 1/8"W x 6 7/8"H
MA-651	20" Tool Box-deep bottom with pull out tray. 20 1/4"L x 10 7/8"W x 9 1/4"

LIGHT EXECUTIVE TOOL CASE FOR METERS, TESTERS AND LIGHTWEIGHT TOOLS

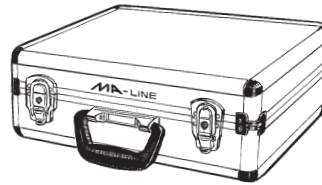

INTERIOR



MA-5TC
MA-5TCA

NOT RECOMMENDED FOR HEAVY TOOLS. OVERFILLING WITH HEAVY TOOLS WILL RESULT IN DISRUPTION OF THE HINGES AND DOES NOT CONSTITUTE WARRANTY.

90 Day Warranty / Subject to Inspection

Part	Description
MA-5TC	Executive tool case with dividers; black panels Dimensions: 18 x 13 x 6 Aluminum trim, rounded corners
MA-5TCA	Executive tool case with dividers, aluminum color panels Dimensions: 18 x 13 x 6 Aluminum trim, rounded corners
MA-5DIV	Set of 5 dividers for all tool cases
MA-TPB-1	Bottom tool panel
MA-TPT-1	Top tool panel

PUNCTURE RESISTANT NYLON TOOL BAGS



MA-96400

UTILITY BAG is designed for basic tool carrying needs. Oversized, zippered opening allows easy access to the inside. Heavy stitched straps allow for easy carrying.

Part	Description
MA-96400	Utility Bag

ALL PURPOSE FIRST AID KIT



- 1 Carry anywhere plastic case
- 4 Extra-strength non-aspirin tablets
- 2 Ibuprofen tablets
- 2 Aspirin tablets
- 12 Antiseptic cleansing wipes (sting free)
- 8 Alcohol cleansing pads
- 4 Antibiotic ointment packs
- 1 Burn relief pack
- 1 Emergency Blanket 38" x 60"
- 1 Instant cold compress
- 5 Butterfly wound closures
- 1 Burn Relief Gel Packs
- 1 First aid tape roll 1/2" x 5 yds.
- 1 Finger splint 6" x 3/4"
- 50 Plastic bandages 3/4" x 3"
- 10 Fabric bandages 3/4" x 3"
- 20 Plastic bandages 1" x 3"
- 20 Junior adhesive plastic bandages 3/8" x 1-1/2"
- 8 Knuckle fabric bandages
- 8 Fingertip fabric bandages
- 1 Elbow & knee plastic bandage 2" x 4"
- 12 Spot bandages 7/8" x 7/8"
- 2 Gauze dressing pads, 3" x 3"
- 10 Gauze dressing pads, 2" x 2"
- 1 Trauma pad 5" x 9"
- 1 Sterile eye pad
- 1 American Medical Assoc. First Aid Guide
- 1 Tweezers, plastic
- 10 Cotton-tipped applicators, 3"
- 2 Latex-free exam quality vinyl gloves

Part	Description
MA-FA134	200-Piece First Aid Kit

THERMOSTAT COVERS

LOW PROFILE STYLE

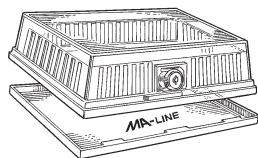

Part	Description	CTN Qty.
MA-BTGDK	Clear Plastic (2 Bases)	12
MA-BTGDB	Bronze Plastic (2 Bases)	12
MA-F336	Universal Key	1

Inside Dimensions

Base Type	Height	Width
Dual Solid	4-1/4"	7-5/8"
Dual Ring	4-1/8"	7-1/16"

DELUXE SERIES

IDEAL For HORIZONTAL AND VERTICAL STANDARD SIZE WALL THERMOSTATS

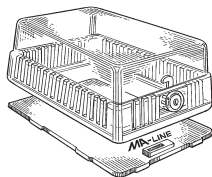

Part	Description	CTN Qty.
MA-BTGRK	Clear Plastic (2 Bases)	12
MA-F336	Universal Key	1

Inside Dimensions

Base Type	Height	Width	Depth
Solid	6-3/8"	3-1/2"	3"
Ring	6-3/8"	3-1/2"	3-1/4"

SMALL AND COMPACT

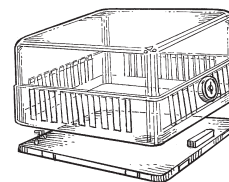

Part	Description
MA-BTGEK	Clear Plastic
MA-F336	Universal Key

Inside Dimensions

Base Type	Height	Width	Depth
Solid	3-1/2"	3-7/8"	2-1/2"

MEDIUM SIZE

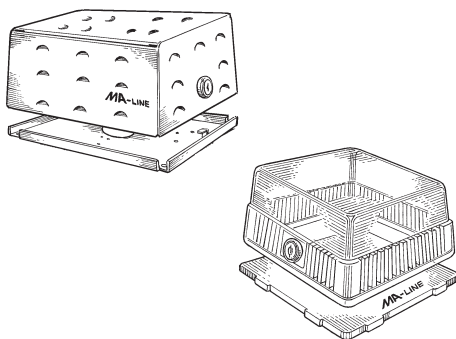

Part	Description	CTN Qty.
MA-BTGGK	Clear Plastic Dual (2 Bases)	12
MA-BTGO	Opaque Plastic Dual (2 Bases)	12
MA-BTGKM	Beige Metal, Solid	12
MA-F336	Universal Key	1

Inside Dimensions

Base Type	Height	Width	Depth
Solid	4-3/8"	5-1/4"	3"
Ring	4-5/8"	5-1/4"	3-1/4"

TAMPER PROOF SERIES

THIS STRONG THERMOSTAT GUARD, CAN BE MOUNTED HORIZONTAL OR VERTICAL AND IS COMPLETELY TAMPER PROOF.

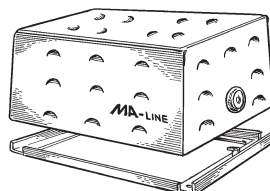

Part	Description	CTN Qty.
MA-BTG54VL	Beige Metal, Solid	12
MA-BTG54VLW	Beige Metal, Ring	12
MA-F336	Universal Key	1

Inside Dimensions

Base Type	Height	Width	Depth
SOLID	6-1/4"	4-3/4"	3"
RING	6"	3-13/16"	3-1/8"

UNIVERSAL SERIES

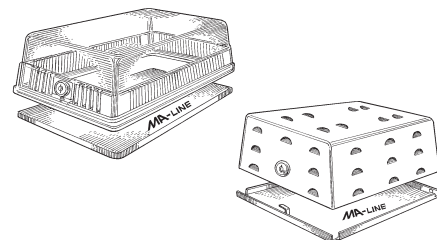

Part	Description	CTN Qty.
MA-BTGUK2	Clear Plastic (2 Bases)	12
MA-BTGUM	Beige Metal, Solid	12
MA-BTGUWM	Beige Metal, Ring	12
MA-F336	Universal Key	1

Plastic Inside Dimensions

Base Type	Height	Width	Depth
Solid	8-1/4"	5-3/8"	3-1/2"
Ring	8-1/8"	4-5/8"	3-5/8"

Metal Inside Dimensions

Base Type	Height	Width	Depth
Solid	7-1/4"	5-3/8"	3-1/2"
Ring	6-3/4"	4-1/4"	3-9/16"

UNIVERSAL SERIES

STRONG STEEL CONSTRUCTION, COVERS ANY WALL THERMOSTAT, MODERN WHITE FINISH, HINGED ON END

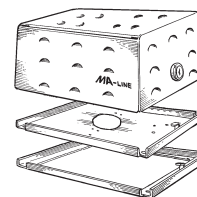
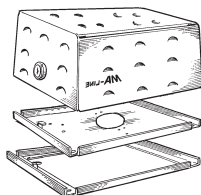

Part	Description	CTN Qty.
MA-BTGUM2	Universal, White Includes: hinged combination solid or ring base Replaces Model Numbers MA-BTGUM1 and MA-BTGUWM1	12

Inside Dimensions

Base	Height	Width	Depth
Ring	6-3/4"	9-3/8"	3"
Opening	6-3/4"	9-3/8"	3"
Dimensions of Ring Base	5-1/2"	8-1/4"	3/8"

REGISTERS, GRILLS, AND DIFFUSERS

372 Series
White Return Air Grill
Replaces MA29R Series

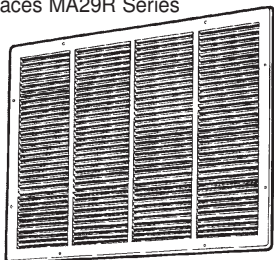

1800 Series
Damper
Assembly
Replaces
MA78 &
MA78R Series

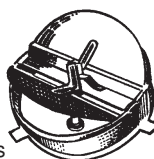

3015 Series
White Baseboard Diffuser
Replaces MA175R Series

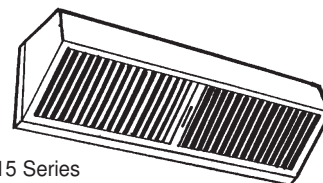

1500 Series
White Ceiling Diffuser
Replaces MA77 &
77R Series

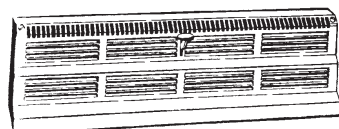
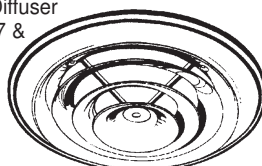

3018 Series
White Baseboard Diffuser
Replaces MA55R Series

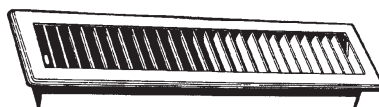

413 Series
Brown Floor Diffuser
Replaces MA150R Series

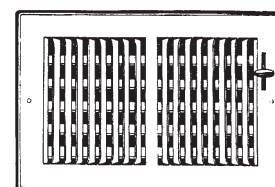

382 Series
White Sidewall Register
Replaces MA130R Series

A quality line of painted steel grilles and registers for residential and light commercial use.

Please call for availability of sizes not listed.

	Part	Description	Opening Size Inches	Free Area Sq. In.	Per Carton	Overall Size Inches
382W SERIES	382W8X4-R	8x4 Sidewall Register	8x4	18	10	9 1/2 x 5 1/2
	382W8X6-R	8x6 Sidewall Register	8x6	29	10	9 1/2 x 7 1/2
	382W8X8-R	8x8 Sidewall Register	8x8	40	10	9 1/2 x 9 1/2
	382W10X4-R	10x4 Sidewall Register	10x4	24	10	11 1/2 x 5 1/2
	382W10X6-R	10x6 Sidewall Register	10x6	38	10	11 1/2 x 7 1/2
	382W10X8-R	10x8 Sidewall Register	10x8	52	10	11 1/2 x 9 1/2
	382W12X4-R	12 x 4 Sidewall Register	12x4	30	10	13 1/2 x 5 1/2
	382W12X6-R	12x6 Sidewall Register	12x6	46	10	13 1/2 x 7 1/2
	382W12X8-R	12x8 Sidewall Register	12x8	63	10	13 1/2 x 9 1/2
	382W14X4-R	14x4 Sidewall Register	14x4	35	10	15 1/2 x 5 1/2
	382W14X6-R	14x6 Sidewall Register	14x6	55	10	15 1/2 x 7 1/2
	382W14X8-R	14x8 Sidewall Register	14x8	75	10	15 1/2 x 9 1/2
3015W SERIES	3015W15-R	15" Baseboard Diffuser	15	38	12	15
3018W SERIES	3018W18-R	18" Baseboard Diffuser	18	33	12	18
372W SERIES	372W8X8	8x8 Return Air Grill	18	43	10	9 7/8 x 9 7/8
	372W10X4	10x4 Return Air Grill	10x4	26	10	11 7/8 x 5 7/8
	372W10X6	10x6 Return Air Grill	10x6	39	10	11 7/8 x 7 7/8
	372W10X8	10x8 Return Air Grill	10x8	52	10	11 7/8 x 9 7/8
	372W12X4	12x4 Return Air Grill	12x4	31	10	13 7/8 x 5 7/8
	372W12X6	12x6 Return Air Grill	12x6	47	10	13 7/8 x 7 7/8
	372W12X8	12x8 Return Air Grill	12x8	64	10	13 7/8 x 9 7/8
	372W12X12	12x12 Return Air Grill	12x12	96	10	13 7/8 x 13 7/8
	372W14X6	14x6 Return Air Grill	14x6	56	10	15 7/8 x 7 7/8
	372W14X8	14x8 Return Air Grill	14x8	75	10	15 7/8 x 9 7/8
	372W14X14	14x14 Return Air Grill	14x14	132	10	15 7/8 x 15 7/8
	372W14X20	14x20 Return Air Grill	14x20	182	10	15 7/8 x 21 7/8
372W20X20	20x20 Return Air Grill	20x20	262	5	21 1/4 x 21 7/8	
372W30X6	30x6 Return Air Grill	30x6	118	5	31 7/8 x 7 7/8	
413B SERIES	413B2X10-R	10x2 1/4 Floor Diffuser Brown	10x2 1/4	13	10	11 5/16 x 3 9/16
	413B4X10-R	10x4 Floor Diffuser Brown	10x4	25	10	11 5/16 x 5 5/16
	413B2X12-R	12x2 1/4 Floor Diffuser Brown	12 x 2 1/4	16	10	13 5/16 x 3 5/16
	413B4X12-R	12x4 Floor Diffuser Brown	14x4	30	10	13 5/16 x 5 5/16
1500W SERIES	1500W6	6" Ceiling Diffuser, White	6	23	10	10
	1500W8	8" Ceiling Diffuser, White	8	40	10	12
	1500W10	10" Ceiling Diffuser, White	10	61	10	14
1800B SERIES	1800B6	6" Round Damper	6	6	10	6 3/4
	1800B8	8" Round Damper	8	8	10	9 1/2
	1800B10	10" Round Damper	10	10	10	11 1/2

LOUVERED VENT HOOD

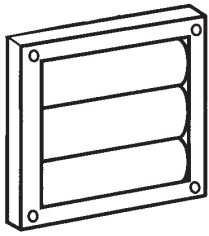

NO BIRD GUARD

Part	Description
MA-HS4W	4" White Louvered Hood
MA-HS4B	4" Brown Louvered Hood

LOUVERED VENT HOOD WITH BUILT-IN BIRD GUARD

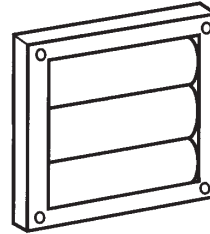

Part	Description
MA-HSB4W	4" White Hood with Bird Guard
MA-HSB4B	4" Brown Hood with Bird-Guard

DRYER VENT WIDE MOUTH HOOD

INCLUDES HOOD, ALUMINUM PIPE AND COLLAR

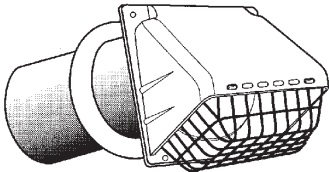

Part	Description
MA-RVHAW4	4" White hood assembled
MA-RVHAB4	4" Brown hood assembled
MA-RVHUW4	4" White hood unassembled
MA-RVHUB4	4" Brown hood unassembled

SUPURR-VENT LOUVERED VENT HOOD

INCLUDES HOOD, ALUMINUM PIPE AND COLLAR

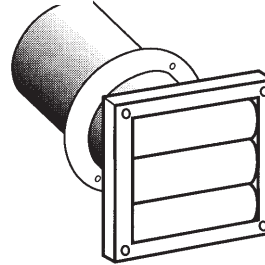

Part	Description
MA-SVHAW4	4" White hood assembled
MA-SVHAB4	4" Brown hood assembled
MA-SVHUW4	4" White hood unassembled
MA-SVHUB4	4" Brown hood unassembled

METALLIC DUCT

2-PLY WITH REINFORCED SCRIM

UL Listed 181A Class 1 Air Connector



Part	Description
MA-FLS0325	3" X 25' Metallic Duct
MA-FLS0425	4" x 25' Metallic Duct
MA-FLS0450	4" X 50' Metallic Duct

UNIVERSAL BIRD & PEST GUARD

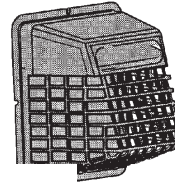

Fits over any 3" or 4" Vent Hood

Part	Description
MA-UBGWB	White Bird Guard
MA-UBGBB	Brown Bird Guard

AIR DEFLECTORS



MA-99

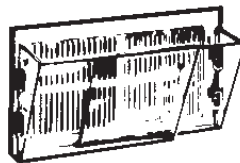

MA-51

Part	Description
MA-99	Magnet Adjustable 10"-14" <i>Cooling-Deflects cold air upwards</i>
MA-51	For Wall Registers Adjustable 10"-16"

SEMI-RIGID (FLEXIBLE) ALUMINUM DUCT



Part	Description
MA-A038	3"x8' Semi-rigid pipe
MA-A048	4"x8' Semi-rigid pipe

CLAMPS



MA-MSC4100

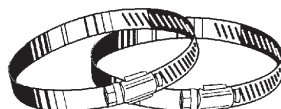

MA-MC450

Part	Description
MA-MC450	4" Metal Worm Drive Clamp
MA-MSC4100	4" Spring Tension Clamp

ALUMINUM PIPES AND ELBOWS

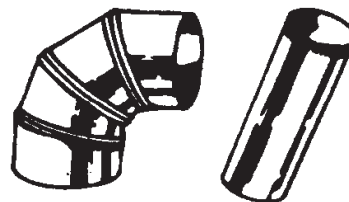

Part	Description
MA-DE904	4"x90" Aluminum elbow
MA-DP244	4"x24" Aluminum pipe

LIGHT WEIGHT, GENERAL PURPOSE REPLACEMENT PLASTIC FAN BLADES

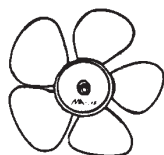

Four and five blade general purpose replacement fan blades with diameters ranging from 3" to 8". These replacement blades are available for shaft sizes of 1/8", 3/16", 1/4", and 5/16". Rotation is identified by the color of the blade. White is for CW rotation and grey is for CCW rotation. All with integral hub.

Part	Rotation	Pitch	Shaft Size	# of Blades	Dia. Inches
MA-CW300	CW	32	1/8	4	3
MA-CW301	CW	32	3/16	4	3
MA-CW401	CW	27	1/8	5	4
MA-CW402	CW	27	3/16	5	4
MA-CCW404	CCW	27	3/16	5	4
MA-CW406	CW	35	1/8	4	4
MA-CW502	CW	22	1/4	5	5
MA-CW503	CW	22	5/16	5	5
MA-CCW504	CCW	22	3/16	5	5
MA-CCW505	CCW	22	1/4	5	5
MA-CCW550	CCW	22	3/16	4	5 1/2
MA-CW601	CW	26	3/16	4	6
MA-CCW604	CCW	24	3/16	4	6
MA-CCW605	CCW	24	1/4	4	6
MA-CCW606	CCW	24	5/16	4	6
MA-CW650	CW	24	3/16	5	6 1/2
MA-CW651	CW	24	1/4	5	6 1/2
MA-CW652	CW	24	5/16	5	6 1/2
MA-CW701	CW	30	1/4	5	7
MA-CCW703	CCW	25	1/4	5	7
MA-CW801	CW	38	1/4	5	8
MA-CW802	CW	38	5/16	5	8

FAN BLADE PITCH GAUGE

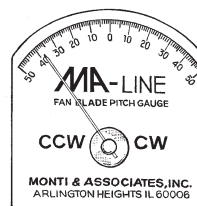

MA-PG1

Part	Description
MA-PG1	Fan Pitch Gauge

PLASTIC REPLACEMENT VENT HOOD FAN BLADES PLASTIC "OEM" DIRECT REPLACEMENT SHAFT AND HUB STYLE FAN BLADES

These "OEM" blades are for specific replacements

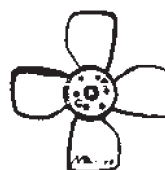

MA-CCW353

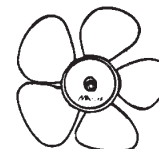

MA-CW660
MA-CW665

Part	Replacement Application	Rotation
MA-CCW353	4" Diameter Whirlpool & Goldspot #513543	CCW
MA-CW660	5" Diameter Replacement Vent Hood Blade	CW
MA-CW665	6-5/8" Diameter Replacement Vent Hood Blade	CW

Part	Outside Length
MA3L310	31
MA3L320	32
MA3L330	33
MA3L340	34
MA3L350	35
MA3L360	36
MA3L370	37
MA3L380	38
MA3L390	39
MA3L400	40
MA3L410	41
MA3L420	42
MA3L430	43
MA3L440	44
MA3L450	45
MA3L460	46
MA3L470	47
MA3L480	48
MA4L170	17
MA4L180	18
MA4L190	19
MA4L200	20
MA4L210	21
MA4L220	22
MA4L230	23
MA4L240	24
MA4L250	25
MA4L260	26
MA4L270	27
MA4L280	28
MA4L290	29
MA4L300	30
MA4L310	31
MA4L320	32
MA4L330	33
MA4L340	34
MA4L350	35

Part	Outside Length
MA4L360	36
MA4L370	37
MA4L380	38
MA4L390	39
MA4L400	40
MA4L410	41
MA4L420	42
MA4L430	43
MA4L440	44
MA4L450	45
MA4L460	46
MA4L470	47
MA4L480	48
MA4L490	49
MA4L500	50
MA4L510	51
MA4L520	52
MA4L530	53
MA4L540	54
MA4L550	55
MA4L560	56
MA4L570	57
MA4L580	58
MA4L590	59
MA4L600	60
MA4L610	61
MA4L620	62
MA4L630	63
MA4L640	64
MA4L650	65
MA4L660	66
MA4L670	67
MA4L680	68
MA4L690	69
MA4L700	70
MA4L710	71
MA4L720	72

V-BELTS MADE TO PERFORM



3L FHP V-Belts 3/8" Top Width, 7/32" Thick
4L (A) V-Belts 1/2" Top Width, 11/32" Thick
5L (B) V-Belts 21/32" Top Width, 13/16" Thick

SPECIAL BELT SIZES
AVAILABLE UPON
REQUEST.

Part	Outside Length	Part	Outside Length
MA5L300	30	MA5L520	52
MA5L310	31	MA5L530	53
MA5L320	32	MA5L540	54
MA5L330	33	MA5L550	55
MA5L340	34	MA5L560	56
MA5L350	35	MA5L570	57
MA5L360	36	MA5L580	58
MA5L370	37	MA5L590	59
MA5L380	38	MA5L600	60
MA5L390	39	MA5L610	61
MA5L400	40	MA5L620	62
MA5L410	41	MA5L630	63
MA5L420	42	MA5L640	64
MA5L430	43	MA5L650	65
MA5L440	44	MA5L660	66
MA5L450	45	MA5L670	67
MA5L460	46	MA5L680	68
MA5L470	47	MA5L690	60
MA5L480	48	MA5L700	70
MA5L490	49	MA5L710	71
MA5L500	50	MA5L720	72
MA5L510	51		

MOTOR MOUNTING BRACKET

For use with Direct Drive Blower Motors. Grommets and eyelets included.

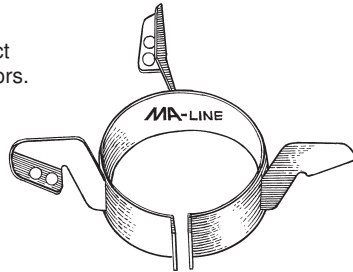

Part	Description
MA-FM50	5" Torsion Bracket
MA-FM55	5.5" Torsion Bracket

MOUNTING BRACKET

Kit includes:
Bracket, Sleeves,
Steel Screws, and
Rubber Grommets

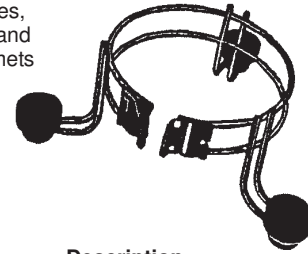

Part	Description
MA60042	5.00" ID-42 Frame
MA60048	5.5" ID-48 Frame

RHEEM MOUNTING BRACKET

Replaces cables used to mount motors on many Rheem condensing units.

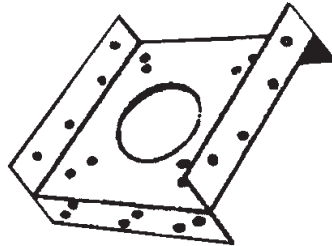

Part	Description
MA60306K	Rheem mounting bracket

LUG MOUNTING BRACKET

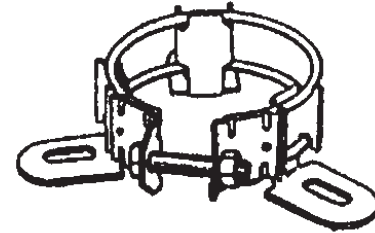

Part	Description
MA80293	For 5.50" Diameter Motors

CONDENSER FAN RAIN SHIELD

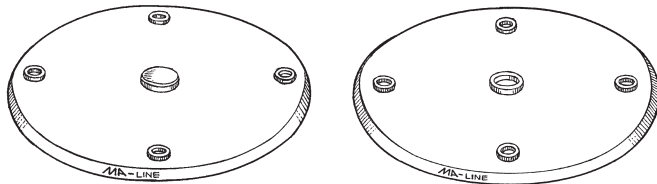

Part	Description
MA61000	1/2" ID x 6.88" OD
MA61056	5/8" ID x 6.88" OD
MA80105	1/2" ID x 7.00 OD

MOUNTING BRACKET ADJUSTABLE BRACKET FOR UNIT BEARING MOTORS Replaces GE 8004



Part	Description
MA68004	Mounting Bracket

RHEEM MOUNTING CABLES

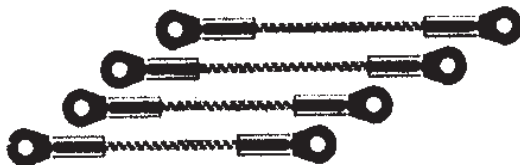

4 Cables per Package

Part	Description
MA60325K	3-1/4" RHEEM Mounting Cable
MA60350K	3-1/2" RHEEM Mounting Cable
MA60378K	3-7/8" RHEEM Mounting Cable

RUBBER GROMMET KIT



Used for 3/4" slots
Screws & Sleeves Included

3 per Package

Part	Description
MA60049K	Rubber Grommet Kit

DUCT TAPE

SILVER 2" X 60 YD.
BLACK 2" X 60 YD.
Adhesive Natural Rubber
24 rolls per case

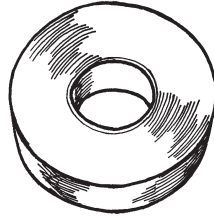

SILVER DUCT TAPE

Part	Description
MA-398	Industrial Grade / 8 mil thickness

BLACK DUCT TAPE

MA-398BL	Industrial Grade / 8 mil thickness
----------	------------------------------------

ALUMINUM FOIL DUCT TAPE UL APPROVED

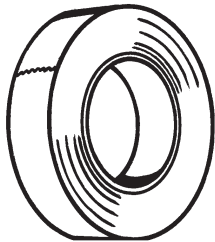

Designed for taping joints and seams against moisture and vapor on foil jacketing insulation.

Temperature Rating:
32°F to 302°F (0°C to 150°C)

Part	Description	Case
MA-322-2	2" x 50 yds.	24
MA-322-3	3" x 50 yds.	16

FURNACE BLOCK

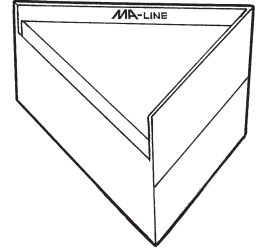

Size: 2-1/4" H x 5-1/2" L x 4" D

Part	Description
MA-68150	Furnace Block

HEAT PUMP STANDS

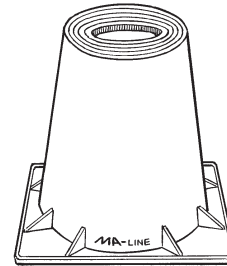

Elevates Heat Pump and Air Handling Units

Made of corrosion-resistant plastic. Butyl mastic on the top and bottom. Absorbs noise and vibration. One piece unit. Does not pull apart.

Part	Description
MA-HP3	3" Gray Pump Stand
MA-HP6	6" Gray Pump Stand

THREADED ROD, NUTS AND WASHERS

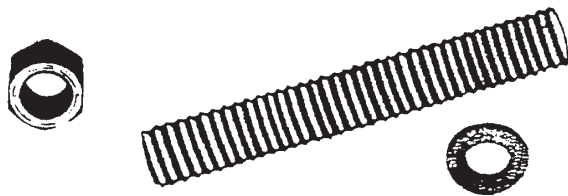

Threaded Rod, Plain Steel

Part	Description
MA-TR14	1/4" - 20 x 6' Length
MA-TR516	5/16" - 18 x 6' Length
MA-TR38	3/8" - 16 x 6' Length
MA-TR12	1/2" - 13 x 6' Length

Finished Hex Nuts, Steel Bright Zinc Plated For Threaded Rod

Part	Description
MA-N14	Zinc finished nuts 1/4" -20
MA-N516	Zinc finished nuts 5/16" - 18
MA-N38	Zinc finished nuts 3/8" - 16
MA-N12	Zinc finished nuts 1/2" - 13

USS Flat Washers, Steel Bright Zinc Plated For Threaded Rod

Part	Description
MA-W14	Zinc finished washer 1/4"
MA-W516	Zinc finished washer 5/16"
MA-W38	Zinc finished washer 3/8"
MA-W12	Zinc finished washer 1/2"

2 PIECE HEAT PUMP STANDS

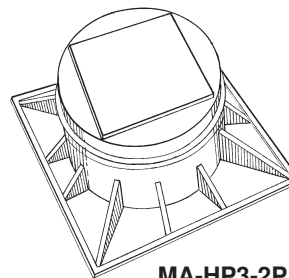

MA-HP3-2P

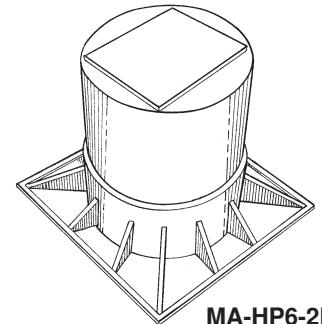

MA-HP6-2P

Part	Description
MA-HP3-2P	3" 2 piece Heat Pump Stand
MA-HP6-2P	6" 2 piece Heat Pump Stand

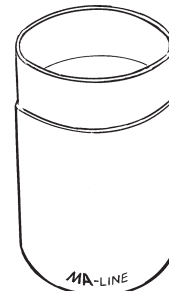

MA-EXT4

Part	Description
MA-EXT4	4" Gray Extension For the 2 piece pull apart units.

EXPANDING POLYURETHANE FOAM SEALANT

SINGLE COMPONENT FOAMS



MA-Line Seal Foam is a single component polyurethane foam used as an insulating sealant. Create a durable air tight seal that will minimize air infiltration, outdoor noise, pest infiltration, and the transfer of odors. When applied it reduces the risk of damage from condensation, moisture and ice buildup. Can reduce air conditioning and heating costs because it provides an excellent R-value. MA-Line Seal Foam can provide greater sealing properties compared to other types or styles of sealants. Unlike caulks and other style sealants, MA-Line Seal foam assumes the shape of the cavity and forms an air tight seal. Does not shrink and will retain sealant properties for many years to come. Products are U.L. classified sealants #13655 and Ashrea 90-75 listed.

Part	Description
MA-1-12X	12 oz. Seal-Foam

TWO COMPONENT FOAMS

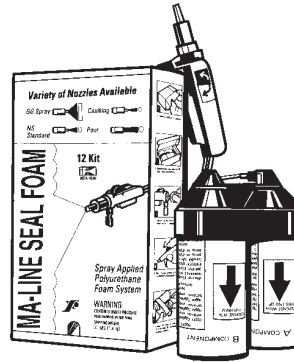

Similar to Seal Foam Single Component Foam, but acts much faster, expands more, and cures much faster. Great for spraying overhead, as it adheres very readily to duct board and sheet metal. Each package provides 12 linear board feet or 1 cubic foot of foam. Ozone friendly closed cell product contains no UREA formaldehyde, sets up in 45 seconds, and cures within 5 minutes.

**OTHER SIZES
AVAILABLE BY REQUEST**

Part	Description
MA-11-12X	12 bd. ft. Seal-Foam II

MASTERFLASH

SIZE RANGE	FLASHING DETAILS	PACK
1/4" - 2" 6mm - 50mm	A = CLOSED B = 1/4" - 2" C = 4 1/8" x 4 1/2"	6
1 1/4" - 3" 32mm - 76mm	A = 7/8" B = 1 1/4" - 3" C = 6" x 6"	6
1/4" - 4" 6mm - 102mm	A = CLOSED B = 1/4" - 4" C = 8" x 8"	6
3" - 6" 76mm - 152mm	A = 2 1/2" B = 3" - 6" C = 10" x 10"	6
4" - 7" 102mm - 178mm	A = 3 1/2" B = 4" - 7" C = 11" x 11"	2
5" - 9" 127mm - 228mm	A = 4" B = 5" - 9" C = 12" x 12"	2
6" - 7" 152mm - 200mm	A = 5" B = 6" - 11" C = 14" x 14"	2
7" - 13" 178mm - 330mm	A = 6" B = 7" - 13" C = 17" x 17"	2



Part	Description
MA-14050	1/4"-2"
MA-14051	1-1/4" - 3"
MA-14052	1/4" - 4"
MA-14053	3" - 6"
MA-14054	4" - 7"
MA-14055	5" - 9"
MA-14056	6" - 7"
MA-14057	7" - 13"

NO-CAULK ROOF FLASHINGS

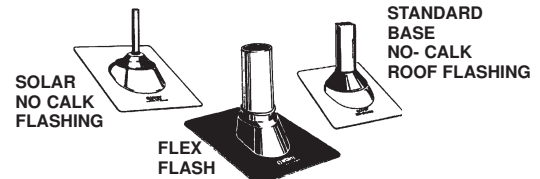

Exclusive one-piece construction insures a positive leakproof installation every time. Specially formulated elastomeric collar allows the vent stack plenty of room for expansion and contraction. Easy to install, the no-caulk flashing slips over the vent stack and automatically adjusts to pipe size and roof angle, and remains perfectly flat on the roof. Not designed for hot-mopped or built up roofs. All flexible flashings such as MA-14012 and MA-14025 are manufactured from a specially formulated elastomer material which is extremely flexible and durable. They permit the vent stack to expand and contract freely without disrupting the seal between the pipe and flashing collar.

Part	Description
MA-11830	1/2"-3/4"-1" Solar No-Caulk Galvanized Base
MA-11840	1-1/4"-1-1/2" No-Caulk Galvanized Base
MA-11853	2" No-Caulk Galvanized Base
MA-11866	3" No-Caulk Galvanized Base
MA-11879	4" No-Caulk Galvanized Base
MA-14012	2" All-Flexible, Rubber Base
MA-14025	2-1/2" All-Flexible, Rubber Bas

BLACK FLASHING CEMENT

ALL WEATHER-NEVER HARDENS
Meets Federal Specifications #SS-C-153C



MA-Line Flashing Cement now comes in a 12.8 oz. tube/cartridge that is perfect for your caulking gun. This all weather flashing cement compound never hardens, and meets Federal specification #SS-C-153. 12 tubes per case. Sold by the case only.

Part	Description	Case
MA-BFC	Black Flashing Cement 12.8 oz. Cartridge	12

BLACK FLASHING CEMENT

ALL WEATHER-NEVER HARDENS
Meets Federal Specifications #SS-C-153C



Part	Description	Case
MA-BF1	Black Flashing Cement Compound 1 Gal.	4

FURNACE CEMENT

Asbestos Free, Gray,
High Heat Cement

Temperature Rating:
0°F to 3000°F



Part	Description	Case
MA-HT64	64 oz. Furnace Cement	6
MA-HT1	1 gal. Furnace Cement	4

PERMANENT MARKING PENS

VALVE ACTION MARKERS

PERMANENT INK MARKS ON METAL, RUBBER, PLASTIC AND MORE



Part	Description	Ctn Qty
MA-44003	Broad Tip Replaces MA-MT44AM	12
MA-84002	Medium Tip Replaces MA-MT916AM	12

LOUVRES FOR CEILINGS, FIXTURES, AND VENTS

UL APPROVED

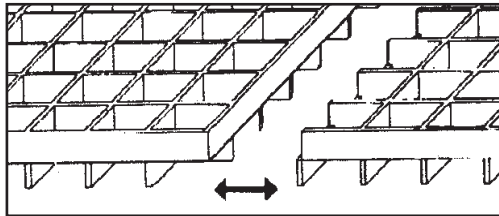

PLASTIC LOUVRES (2' x 4') from MA-Line are UL approved and offer a light diffuser of high efficiency and a minimum of maintenance. Can be installed under sprinklers. Lap edge offers continuous runs without turning the louver.

ALUMINUM LOUVRES (2' x 4') Aluminum louvers from MA-Line meet all building codes and insurance requirements and may be installed under sprinklers. Non-flammable open grid material is distortion free under hot air flow. 10 per case. MA-AL2412W is WHITE ALUMINUM MA-AL2412M is MILL ALUMINUM

Part	Description	Case Qty
MA-EGL20	3/8" Plastic	15
MA-EGL24	1/2" Plastic	10
MA-AL2412W	1/2" White Aluminum	10
MA-AL2412M	1/2" Mill aluminum	10

CENTRAL AIR CONDITIONING COVERS

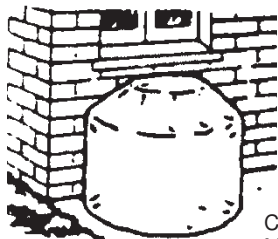

Color: Gray
Material: Vinyl

Part	Description
MA-AC14	Round Central AC Cover

CARBON MONOXIDE DETECTOR

Homes, Kitchens, Garages, Cars, Trucks, Vans, RV's, Campers, Trailers, Cabins, Cottages, Boats, Aircraft, Stoves, Ranges, Water Heaters, Furnace Areas, Boiler Rooms, Furnace, Fishing Shelters, Duck Blinds, Space Heaters, Wood Stoves, Charcoal Grills, Fireplaces, and Work Places.

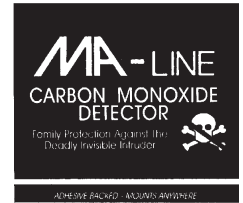

HOW DO I TEST?

Remove from sealed packet only when ready to use. If CO is present, the spot will turn gray or black. Spot will return to original color when air freshens. If spot darkens after several months, replace. Replace at least once per heating season. Shelf life in unopened pack is 3 years.



HOW FAST DOES IT WORK?

(Based on 60% Relative Humidity)

Concentration	Reaction Time
100 ppm (.010%)	15-45 minutes
200 ppm (.020%)	4-15 minutes
400 ppm (.040%)	2-4 minutes
600 ppm (.060%)	1-2 minutes

Note: Reaction time slightly faster when damp, slightly slower when dry. Even a slight grayish color indicates a dangerous carbon monoxide level.

Part	Description
MA-HU1	Carbon Monoxide Detector

PROTECTIVE GAUGE BOOTS

Rubber boots slip easily around gauges to cushion them from impact. Fits standard 2 1/2" and 3 1/8" gauges. Color-coded red or blue to match gauge.

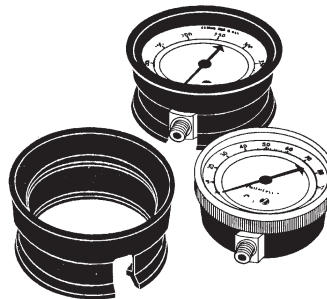

Part	Description
2-1/2" GAUGE BOOTS	
MA-49091	Red Gauge Boot
MA-49092	Blue Gauge Boot
MA-49090	Set of Gauge Boots

Part	Description
3-1/8" GAUGE BOOTS	
MA-49191	Red Gauge Boot
MA-49192	Blue Gauge Boot
MA-49193	Set of Gauge Boots

WINDOW AIR CONDITIONING COVERS

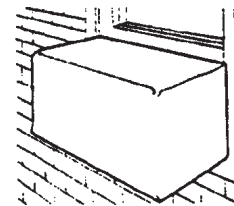

Color: Gray
Material: Vinyl

Part	Description
MA-WU17	Cover for Standard Window Unit. 5,000-10,000 BTU 27"W x 18"H x 18"D

Part	Description
MA-WU21	Cover for Large Window Unit 15,000 and up BTU 28"W x 20"H x 30"D

PUMP STYLE PLASTIC SPRAYERS

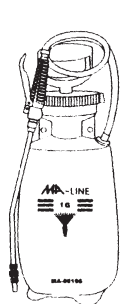

MA-00106

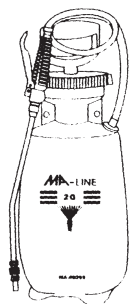

MA-00205

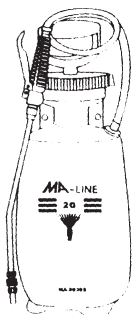

MA-00304

FEATURES:

- Compression Sprayers
- Adjustable Nozzle
- Corrosion Resistant
- Durable Extension Wand

Part	Description
MA-00106	1 Gallon Capacity
MA-00205	2 Gallon Capacity
MA-00304	3 Gallon Capacity

FLEXOGEN GARDEN HOSE AND NOZZLE

INSULATED TRIGGER NOZZLE

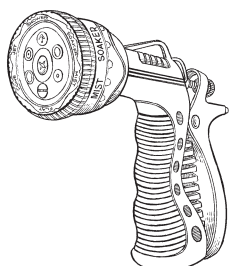
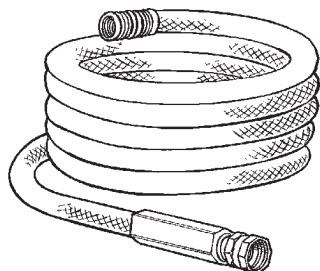

FEATURES:

- Kink resistant
- Double tire cord reinforced for strength
- Glossy smooth cover resists dirt & abrasion
- 8 Ply

- Comfortable Thermoplastic Rubber Grip
- Hold Open Clip for Continuous Spraying
- 6 Spray Patterns: Soaker, Shower, Cone, Flat, Mist and Jet

Part	Description
MA-GH25	5/8" ID Green 25' long
MA-GH50	5/8" ID Green 50' long
MA-W455	Hose Washer – 10/pk
MA-572A	Spray Nozzle

HAND HELD PUMP STYLE SPRAYER

Adjustable spray nozzle, trigger may be locked for continuous operation, chemical resistant.



Part	Description
MA-41500	3 Pint Capacity

TRIGGER SPRAYERS

Multi-purpose trigger sprayer for cleaning solutions, or almost any liquid. Adjustable nozzle for fine mist spray to solid stream; durable polymer head and polyethylene bottle.

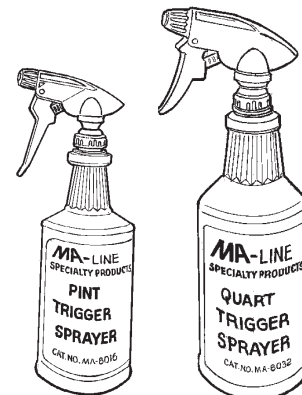

Part	Description	Pkg
MA-8016	Pint Sprayer	12
MA-8032	Quart Sprayer	12

ICE MAKER AND HUMIDIFIER HOOK UP KIT

MA-IMK1 Kit includes: self-tapping valve (Part number MA-VIMK3) and 24' 1/4" O.D. polyethylene tubing.

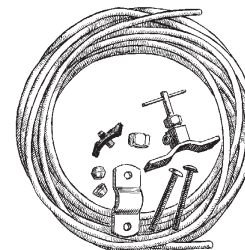

MA-IMK1

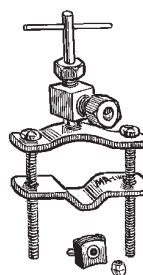

HUMIDIFIER KIT	
Part	Description
SADDLE VALVES—MEETS NSF REQUIREMENTS	
Part	Description
MA-VIMK3	Self-Piercing Valve
MA-VIMK4	1/4" Drill Type Valve
SADDLE VALVE	
Part	Description
MA-VIMK2	Self-Tapping Valve/Clamp Kit
HUMIDIFIER KIT	
Part	Description
MA-IMK1	Humidifier Kit

DELTRIN SLEEVE AND BRASS INSERT

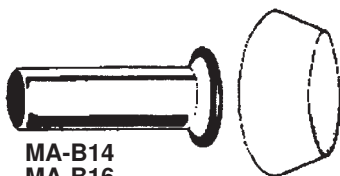

MA-B14
MA-B16

MA-DS4
MA-DS6

Part	Description
MA-DS4	1/4" Delrin Sleeve for 1/4" OD plastic tubing 25/pkg
MA-DS6	3/8" Delrin Sleeve for 3/8" OD plastic tubing 25/pkg
MA-B14	1/4" Brass Insert, for 1/4" OD plastic tubing 25/pkg
MA-B16	3/8" Brass Insert for 3/8" OD plastic tubing 25/pkg

COPPER ICE MAKER AND HUMIDIFIER HOOK UP KIT

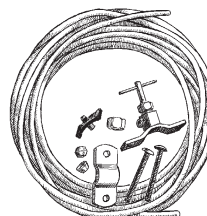

MA-CIMK2

Meets NSF Requirement Valve—Copper tube kit comes complete with 24' copper tube & self-tapping saddlevalve.
 1/4" x 1/8" Compression x MIP Connector
 1/4" Compression Union
 1/4" x 1/8" Compression x MIP Elbow
 Self-tapping valve, installs on copper tube lines from 3/8" O.D. to 1 1/8" O.D.
 No drilling required. Stainless steel pins prevent plug-ups and contamination.

Part	Description
MA-CIMK2	Copper Ice Maker

CLEAR VINYL TUBING

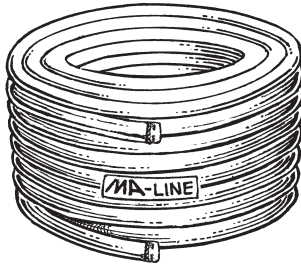

Strong, clear, flexible tubing made of PVC. The uses are numerous. Excellent for air conditioning, refrigeration, condensate drains, humidifier overflowing, condensate pump discharge line. Available in sizes from 1/4" I.D. to 1" I.D.

Service Temperature:
Low 23°F/5°C
High 140°F/60°C.

Part	Description	Working Pressure	Burst Pressure
MA-CVT316	3/16" ID x 100' Roll	40 PSI	120 PSI
MA-CVT14	1/4" ID x 100' Roll	40 PSI	120 PSI
MA-CVT38	3/8" ID x 100' Roll	30 PSI	70 PSI
MA-CVT12	1/2" ID x 100' Roll	30 PSI	70 PSI
MA-CVT58	5/8" ID x 100' Roll	25 PSI	55 PSI
MA-CVT34	3/4" ID x 100' Roll	25 PSI	55 PSI
MA-CVT78	7/8" ID x 50' Roll	25 PSI	50 PSI
MA-CVT1	1" ID x 50' Roll	25 PSI	40 PSI

HEAVY DUTY PVC BRAIDED DRAIN TUBING



SPECIFICATIONS:
TUBE: PVC crystal clear, non toxic
REINFORCEMENT: Synthetic braid
SERVICE TEMPERATURE RANGE:
23° to 140°F (-5°C to 60°C)
HEAVY DUTY DRAIN APPLICATIONS
STANDARD LENGTHS:
1/4" through 1" 50 foot coils.

Part	Size	Working Pressure	Burst Pressure
MA-HDT316	3/16" ID X 50' Roll	250	750
MA-HDT14	1/4" ID X 50' Roll	250	750
MA-HDT38	3/8" ID X 50' Roll	200	600
MA-HDT12	1/2" ID X 50' Roll	150	450
MA-HDT58	5/8" ID X 50' Roll	150	450
MA-HDT34	3/4" ID X 50' Roll	150	450
MA-HDT78	7/8" ID X 50' Roll	150	450
MA-HDT1	1" ID X 50' Roll	125	375

RUBBER DRAIN LINE ELBOWS

FOR QUICK DISCONNECT AND RECONNECT OF DRAIN LINE

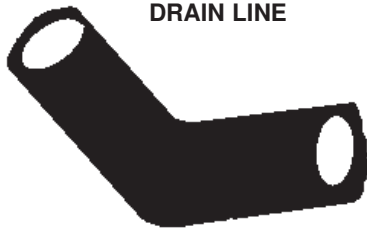

Part	Description
MA-38RUEL	3/8" I.D. Rubber Elbow
MA-34RUEL	3/4" I.D. Rubber Elbow

POLYETHYLENE TUBING



Flexible polyethylene tubing, for humidifiers. Made from non-toxic FDA approved materials. Service Temperature: 140 degrees F.

Part	Description	Max Burst Pressure
MA-PT14	1/4" OD x 100' Roll	206 PSI
MA-PT38	3/8" OD x 100' Roll	140 PSI

VINYL HOSE AND GARDEN HOSE CUTTER

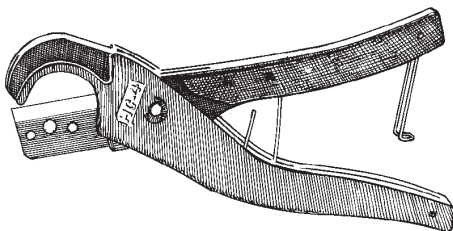

Part	Description
MA-HC-4	Vinyl Hose Cutter

PLASTIC Y STRAINERS



"Y" Strainer especially designed for removing sediment in small flow applications. Typical uses include: beverage dispensing, beverage cooling, vending machines, power humidifiers, ice machines. FDA approved, 125 lbs, corrosion free 100 mesh screen plug which is easily removed for cleaning.

Part	Description
MA-S14	1/4"
MA-S38	3/8"

NYLON FITTINGS

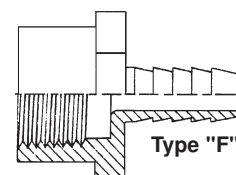
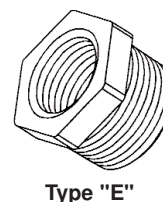
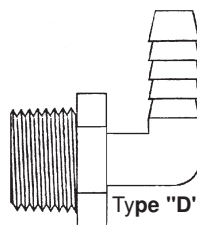
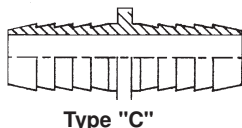
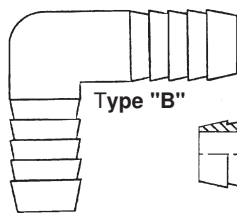
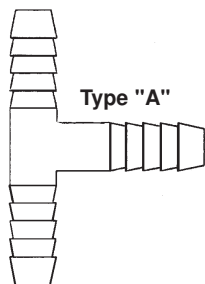

Part	Description	Type	Pkg
MA-22157	Tee 1/4" Barb	A	5
MA-22157-25	Tee 1/4" Barb	A	25
MA-22157-50	Tee 1/4" Barb	A	50
MA-22157-100	Tee 1/4" Barb	A	100
MA-22159	Tee 3/8" Barb	A	5
MA-22159-25	Tee 3/8" Barb	A	25
MA-22159-50	Tee 3/8" Barb	A	50
MA-22159-100	Tee 3/8" Barb	A	100
MA-22160	Tee 1/2" Barb	A	4
MA-22160-25	Tee 1/2" Barb	A	25
MA-22160-50	Tee 1/2" Barb	A	50
MA-22160-100	Tee 1/2" Barb	A	100
MA-22161	Tee 5/8" Barb	A	4
MA-22161-25	Tee 5/8" Barb	A	25
MA-22161-50	Tee 5/8" Barb	A	50
MA-22161-100	Tee 5/8" Barb	A	100
MA-22286	Tee 3/4" Barb	A	4
MA-22286-25	Tee 3/4" Barb	A	25
MA-22286-50	Tee 3/4" Barb	A	50
MA-22286-100	Tee 3/4" Barb	A	100
MA-22151	Elbow 1/4" Barb	B	5
MA-22151-25	Elbow 1/4" Barb	B	25
MA-22151-50	Elbow 1/4" Barb	B	50
MA-22151-100	Elbow 1/4" Barb	B	100
MA-22152	Elbow 3/8" Barb	B	5
MA-22152-25	Elbow 3/8" Barb	B	25
MA-22152-50	Elbow 3/8" Barb	B	50
MA-22152-100	Elbow 3/8" Barb	B	100
MA-22153	Elbow 1/2" Barb	B	4
MA-22153-25	Elbow 1/2" Barb	B	25
MA-22153-50	Elbow 1/2" Barb	B	50
MA-22153-100	Elbow 1/2" Barb	B	100
MA-22154	Elbow 5/8" Barb	B	4
MA-22154-25	Elbow 5/8" Barb	B	25
MA-22154-50	Elbow 5/8" Barb	B	50
MA-22154-100	Elbow 5/8" Barb	B	100
MA-22192	Elbow 3/4" Barb	B	3
MA-22192-25	Elbow 3/4" Barb	B	25
MA-22192-50	Elbow 3/4" Barb	B	50
MA-22192-100	Elbow 3/4" Barb	B	100
MA-22031	Connector 1/4" Barb	C	5
MA-22031-25	Connector 1/4" Barb	C	25
MA-22031-50	Connector 1/4" Barb	C	50
MA-22031-100	Connector 1/4" Barb	C	100
MA-12032	Connector 3/8" Barb	C	5
MA-12032-25	Connector 3/8" Barb	C	25
MA-12032-50	Connector 3/8" Barb	C	50
MA-12032-100	Connector 3/8" Barb	C	100
MA-12033	Connector 1/2" Barb	C	4
MA-12033-25	Connector 1/2" Barb	C	25
MA-12033-50	Connector 1/2" Barb	C	50
MA-12033-100	Connector 1/2" Barb	C	100
MA-12034	Connector 5/8" Barb	C	4
MA-12034-25	Connector 5/8" Barb	C	25
MA-12034-50	Connector 5/8" Barb	C	50
MA-12034-100	Connector 5/8" Barb	C	100
MA-12035	Connector 3/4" Barb	C	3
MA-12035-25	Connector 3/4" Barb	C	25
MA-12035-50	Connector 3/4" Barb	C	50
MA-12035-100	Connector 3/4" Barb	C	100
MA-22263	Elbow 1/4" Barb x 1/4" MPT	D	5
MA-22263-25	Elbow 1/4" Barb x 1/4" MPT	D	25
MA-22263-50	Elbow 1/4" Barb x 1/4" MPT	D	50
MA-22263-100	Elbow 1/4" Barb x 1/4" MPT	D	100

Part	Description	Type	Pkg
MA-22264	Elbow 1/4" Barb x 3/8" MPT	D	4
MA-22264-25	Elbow 1/4" Barb x 3/8" MPT	D	25
MA-22264-50	Elbow 1/4" Barb x 3/8" MPT	D	50
MA-22264-100	Elbow 1/4" Barb x 3/8" MPT	D	100
MA-22112	Elbow 3/8" Barb x 3/8" MPT	D	4
MA-22112-25	Elbow 3/8" Barb x 3/8" MPT	D	25
MA-22112-50	Elbow 3/8" Barb x 3/8" MPT	D	50
MA-22112-100	Elbow 3/8" Barb x 3/8" MPT	D	100
MA-22113	Elbow 3/8" Barb x 1/2" MPT	D	4
MA-22113-25	Elbow 3/8" Barb x 1/2" MPT	D	25
MA-22113-50	Elbow 3/8" Barb x 1/2" MPT	D	50
MA-22113-100	Elbow 3/8" Barb x 1/2" MPT	D	100
MA-22114	Elbow 3/8" Barb x 3/4" MPT	D	4
MA-22114-25	Elbow 3/8" Barb x 3/4" MPT	D	25
MA-22114-50	Elbow 3/8" Barb x 3/4" MPT	D	50
MA-22114-100	Elbow 3/8" Barb x 3/4" MPT	D	100
MA-22116	Elbow 1/2" Barb x 1/2" MPT	D	4
MA-22116-25	Elbow 1/2" Barb x 1/2" MPT	D	25
MA-22116-50	Elbow 1/2" Barb x 1/2" MPT	D	50
MA-22116-100	Elbow 1/2" Barb x 1/2" MPT	D	100
MA-22117	Elbow 1/2" Barb x 3/4" MPT	D	4
MA-22117-25	Elbow 1/2" Barb x 3/4" MPT	D	25
MA-22117-50	Elbow 1/2" Barb x 3/4" MPT	D	50
MA-22117-100	Elbow 1/2" Barb x 3/4" MPT	D	100
MA-22120	Elbow 5/8" Barb x 3/4" MPT	D	4
MA-22120-25	Elbow 5/8" Barb x 3/4" MPT	D	25
MA-22120-50	Elbow 5/8" Barb x 3/4" MPT	D	50
MA-22120-100	Elbow 5/8" Barb x 3/4" MPT	D	100
MA-22122	Elbow 3/4" Barb x 3/4" MPT	D	4
MA-22122-25	Elbow 3/4" Barb x 3/4" MPT	D	25
MA-22122-50	Elbow 3/4" Barb x 3/4" MPT	D	50
MA-22122-100	Elbow 3/4" Barb x 3/4" MPT	D	100
MA-12052	Bushing 1/2" MPT x 3/8" FPT	E	4
MA-12052-25	Bushing 1/2" MPT x 3/8" FPT	E	25
MA-12052-50	Bushing 1/2" MPT x 3/8" FPT	E	50
MA-12052-100	Bushing 1/2" MPT x 3/8" FPT	E	100
MA-12053	Bushing 3/4" MPT x 1/2" FPT	E	4
MA-12053-25	Bushing 3/4" MPT x 1/2" FPT	E	25
MA-12053-50	Bushing 3/4" MPT x 1/2" FPT	E	50
MA-12053-100	Bushing 3/4" MPT x 1/2" FPT	E	100
MA-12054	Bushing 1" MPT x 3/4" FPT	E	4
MA-12054-25	Bushing 1" MPT x 3/4" FPT	E	25
MA-12054-50	Bushing 1" MPT x 3/4" FPT	E	50
MA-12054-100	Bushing 1" MPT x 3/4" FPT	E	100
MA-12055	Bushing 1-1/4" MPT x 1" FPT	E	1
MA-12056	Bushing 1-1/2" MPT x 1-1/4" FPT	E	1
MA-12057	Bushing 2" MPT x 1-1/2" FPT	E	1
MA-22182	Adaptor 1/2" Barb x 1/2" FPT	F	4
MA-22182-25	Adaptor 1/2" Barb x 1/2" FPT	F	25
MA-22182-50	Adaptor 1/2" Barb x 1/2" FPT	F	50
MA-22182-100	Adaptor 1/2" Barb x 1/2" FPT	F	100
MA-22185	Adaptor 1/2" Barb x 3/4" FPT	F	4
MA-22185-25	Adaptor 1/2" Barb x 3/4" FPT	F	25
MA-22185-50	Adaptor 1/2" Barb x 3/4" FPT	F	50
MA-22185-100	Adaptor 1/2" Barb x 3/4" FPT	F	100
MA-22186	Adaptor 5/8" Barb x 3/4" FPT	F	4
MA-22186-25	Adaptor 5/8" Barb x 3/4" FPT	F	25
MA-22186-50	Adaptor 5/8" Barb x 3/4" FPT	F	50
MA-22186-100	Adaptor 5/8" Barb x 3/4" FPT	F	100
MA-22187	Adaptor 3/4" Barb x 3/4" FPT	F	4
MA-22187-25	Adaptor 3/4" Barb x 3/4" FPT	F	25
MA-22187-50	Adaptor 3/4" Barb x 3/4" FPT	F	50
MA-22187-100	Adaptor 3/4" Barb x 3/4" FPT	F	100

NYLON FITTINGS

Type "G"

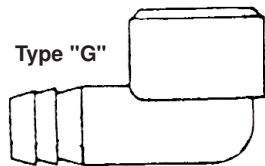

Type "H"

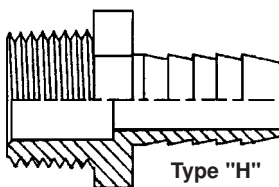

Type "I"

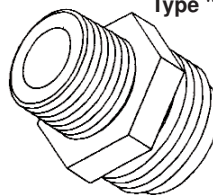

Type "O"



Type "J"

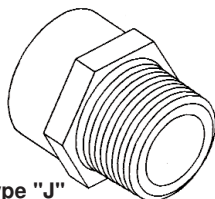

Type "K"

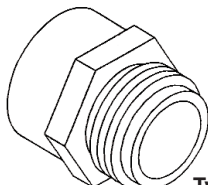

Type "L"

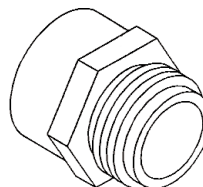

Part	Description	Type	Pkg
MA-22065	Elbow 1/2" Barb x 3/4" FPT	G	4
MA-22065-25	Elbow 1/2" Barb x 3/4" FPT	G	25
MA-22065-50	Elbow 1/2" Barb x 3/4" FPT	G	50
MA-22065-100	Elbow 1/2" Barb x 3/4" FPT	G	100
MA-22064	Elbow 5/8" Barb x 3/4" FPT	G	4
MA-22064-25	Elbow 5/8" Barb x 3/4" FPT	G	25
MA-22064-50	Elbow 5/8" Barb x 3/4" FPT	G	50
MA-22064-100	Elbow 5/8" Barb x 3/4" FPT	G	100
MA-22066	Elbow 3/4" Barb x 3/4" FPT	G	4
MA-22066-25	Elbow 3/4" Barb x 3/4" FPT	G	25
MA-22066-50	Elbow 3/4" Barb x 3/4" FPT	G	50
MA-22066-100	Elbow 3/4" Barb x 3/4" FPT	G	100
MA-22002	Adaptor 1/4" Barb x 1/4" MPT	H	10
MA-22002-25	Adaptor 1/4" Barb x 1/4" MPT	H	25
MA-22002-50	Adaptor 1/4" Barb x 1/4" MPT	H	50
MA-22002-100	Adaptor 1/4" Barb x 1/4" MPT	H	100
MA-22003	Adaptor 1/4" Barb x 3/8" MPT	H	10
MA-22003-25	Adaptor 1/4" Barb x 3/8" MPT	H	25
MA-22003-50	Adaptor 1/4" Barb x 3/8" MPT	H	50
MA-22003-100	Adaptor 1/4" Barb x 3/8" MPT	H	100
MA-22005	Adaptor 3/8" Barb x 3/8" MPT	H	10
MA-22005-25	Adaptor 3/8" Barb x 3/8" MPT	H	25
MA-22005-50	Adaptor 3/8" Barb x 3/8" MPT	H	50
MA-22005-100	Adaptor 3/8" Barb x 3/8" MPT	H	100
MA-22006	Adaptor 3/8" Barb x 1/2" MPT	H	8
MA-22006-25	Adaptor 3/8" Barb x 1/2" MPT	H	25
MA-22006-50	Adaptor 3/8" Barb x 1/2" MPT	H	50
MA-22006-100	Adaptor 3/8" Barb x 1/2" MPT	H	100
MA-22007	Adaptor 1/2" Barb x 3/8" MPT	H	8
MA-22007-25	Adaptor 1/2" Barb x 3/8" MPT	H	25
MA-22007-50	Adaptor 1/2" Barb x 3/8" MPT	H	50
MA-22007-100	Adaptor 1/2" Barb x 3/8" MPT	H	100
MA-22010	Adaptor 1/2" Barb x 1/2" MPT	H	6
MA-22010-25	Adaptor 1/2" Barb x 1/2" MPT	H	25
MA-22010-50	Adaptor 1/2" Barb x 1/2" MPT	H	50
MA-22010-100	Adaptor 1/2" Barb x 1/2" MPT	H	100
MA-22013	Adaptor 3/8" Barb x 3/4" MPT	H	4
MA-22013-25	Adaptor 3/8" Barb x 3/4" MPT	H	25
MA-22013-50	Adaptor 3/8" Barb x 3/4" MPT	H	50
MA-22013-100	Adaptor 3/8" Barb x 3/4" MPT	H	100
MA-22010	Adaptor 1/2" Barb x 3/4" MPT	H	4
MA-22010-25	Adaptor 1/2" Barb x 3/4" MPT	H	25
MA-22010-50	Adaptor 1/2" Barb x 3/4" MPT	H	50
MA-22010-100	Adaptor 1/2" Barb x 3/4" MPT	H	100
MA-22012	Adaptor 5/8" Barb x 3/4" MPT	H	4
MA-22012-25	Adaptor 5/8" Barb x 3/4" MPT	H	25
MA-22012-50	Adaptor 5/8" Barb x 3/4" MPT	H	50
MA-22012-100	Adaptor 5/8" Barb x 3/4" MPT	H	100
MA-22014	Adaptor 3/4" Barb x 3/4" MPT	H	4
MA-22014-25	Adaptor 3/4" Barb x 3/4" MPT	H	25
MA-22014-50	Adaptor 3/4" Barb x 3/4" MPT	H	50
MA-22014-100	Adaptor 3/4" Barb x 3/4" MPT	H	100

Part	Description	Type	Pkg
MA-12010	Adaptor 3/4" Mght x 3/4" FPT	K	4
MA-12010-25	Adaptor 3/4" Mght x 3/4" FPT	K	25
MA-12010-50	Adaptor 3/4" Mght x 3/4" FPT	K	50
MA-12010-100	Adaptor 3/4" Mght x 3/4" FPT	K	100
MA-12004	Adaptor 3/4" Mght x 3/4" MPT	I	4
MA-12004-25	Adaptor 3/4" Mght x 3/4" MPT	I	25
MA-12004-50	Adaptor 3/4" Mght x 3/4" MPT	I	50
MA-12004-100	Adaptor 3/4" Mght x 3/4" MPT	I	100
MA-12060	Adaptor 3/4" Mght x 3/4" Fght	K	3
MA-12060-25	Adaptor 3/4" Mght x 3/4" Fght	K	25
MA-12060-50	Adaptor 3/4" Mght x 3/4" Fght	K	50
MA-12060-100	Adaptor 3/4" Mght x 3/4" Fght	K	100
MA-22048	Adaptor 3/4" Fght x 5/8" Barb	L	4
MA-22048-25	Adaptor 3/4" Fght x 5/8" Barb	L	25
MA-22048-50	Adaptor 3/4" Fght x 5/8" Barb	L	50
MA-22048-100	Adaptor 3/4" Fght x 5/8" Barb	L	100
MA-22049	Adaptor 3/4" Fght x 3/4" Barb	L	4
MA-22049-25	Adaptor 3/4" Fght x 3/4" Barb	L	25
MA-22049-50	Adaptor 3/4" Fght x 3/4" Barb	L	50
MA-22049-100	Adaptor 3/4" Fght x 3/4" Barb	L	100
MA-12013	Adaptor 3/4" MPT x 3/4" Fght	J	4
MA-12013-25	Adaptor 3/4" MPT x 3/4" Fght	J	25
MA-12013-50	Adaptor 3/4" MPT x 3/4" Fght	J	50
MA-12013-100	Adaptor 3/4" MPT x 3/4" Fght	J	100
MA-22289	Tee 3/4" x 1/2" x 1/2" Barb	A	4
MA-22289-25	Tee 3/4" x 1/2" x 1/2" Barb	A	25
MA-22289-50	Tee 3/4" x 1/2" x 1/2" Barb	A	50
MA-22289-100	Tee 3/4" x 1/2" x 1/2" Barb	A	100
MA-22290	Tee 1/2" MPT x 1/2" B x 1/2" B	N	4
MA-22290-25	Tee 1/2" MPT x 1/2" B x 1/2" B	N	25
MA-22290-50	Tee 1/2" MPT x 1/2" B x 1/2" B	N	50
MA-22290-100	Tee 1/2" MPT x 1/2" B x 1/2" B	N	100
MA-TN5044	Nipple 1/4" MPT x 1/4" MPT	O	4
MA-TN5044-25	Nipple 1/4" MPT x 1/4" MPT	O	25
MA-TN5044-50	Nipple 1/4" MPT x 1/4" MPT	O	50
MA-TN5044-100	Nipple 1/4" MPT x 1/4" MPT	O	100
MA-TN5066	Nipple 3/8" MPT x 3/8" MPT	O	4
MA-TN5066-25	Nipple 3/8" MPT x 3/8" MPT	O	25
MA-TN5066-50	Nipple 3/8" MPT x 3/8" MPT	O	50
MA-TN5066-100	Nipple 3/8" MPT x 3/8" MPT	O	100
MA-TN5088	Nipple 1/2" MPT x 1/2" MPT	O	4
MA-TN5088-25	Nipple 1/2" MPT x 1/2" MPT	O	25
MA-TN5088-50	Nipple 1/2" MPT x 1/2" MPT	O	50
MA-TN5088-100	Nipple 1/2" MPT x 1/2" MPT	O	100
MA-TN51212	Nipple 3/4" MPT x 3/4" MPT	O	4
MA-TN51212-25	Nipple 3/4" MPT x 3/4" MPT	O	25
MA-TN51212-50	Nipple 3/4" MPT x 3/4" MPT	O	50
MA-TN51212-100	Nipple 3/4" MPT x 3/4" MPT	O	100

UNIVERSAL DRAIN HEATER

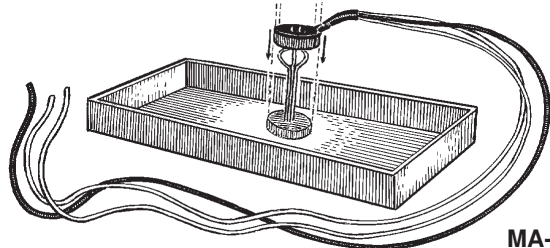

MA-32950

PREVENT DRAIN TUB ICING & PLUGGING

This universal drain heater can be used for all makes and models of refrigerators.

Part	Description
MA-32950	Refrigeration Drain Heater

DRAIN PAN SAFETY SWITCH

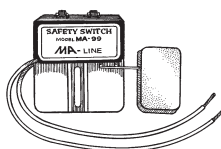

MA-J100

The MA-J100 Drain Pan Safety Switch is a water-level sensing device designed to shut down an air conditioning or refrigeration, in the event of a high water condition in the pan or reservoir. The switch is wired normally closed from the factory and can be field changed to normally open. The switch assembly comes complete with 7" wire leads and installation hardware.

SPECIFICATIONS: 72" Wire Leads, 4 amp Rating, 125/250VAC and UL Recognized.

Part	Description
MA-J100	Safety Switch

CONDENSATE PANS

MA-CP35-120
MA-CP35-240

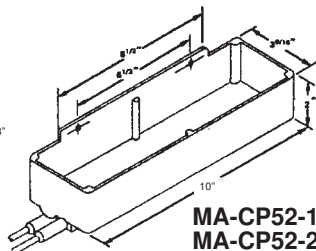
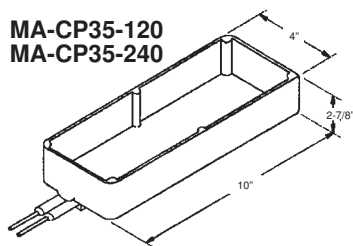

MA-CP52-120
MA-CP52-240

The Ma-Line condensate evaporator pan, which eliminates floor drains, is the latest addition to the MA-LINE. The unit is made of die-cast aluminum. The resulting hard, brilliant surface gives the pan unequalled efficiency and trouble-free operation. The pan is self-standing. All terminal connections are covered with moisture proof rubber. Evaporation rate is 8 oz. per hour at 72° room temperature. The unit's heating element is sealed in 1/4" bundyweld tubing.

MA-CP35 SERIES 120 OR 240V DIMENSIONS
10" L x 2-7/8" D x 4" W

MA-CP52 SERIES 120 OR 240V DIMENSIONS
10" L x 3-3/8" D x 4-1/2" W

Part	Description
MA-CP35-120	38 oz. capacity, 160 watts 120 volts
MA-CP35-240	38 oz. capacity, 160 watts 220 volts
MA-CP52-120	50 oz. capacity, 160 watts 115 volts
MA-CP52-240	50 oz. capacity, 160 watts 220 volts

- COMBO - HEX CLAMP

3/8" Hex head,
collared screw
300 Stainless band and housing
Zinc-plated carbon steel screw



Part	Description	Box Qty
MA-5406BX	Size 06, 3/8" - 7/8" Dia	10
MA-5408BX	Size 08, 7/16" - 1" Dia.	10
MA-5410BX	Size 10, 1/2" - 1-1/8" Dia	10
MA-5412BX	Size 12, 1/2" - 1-1/4" Dia	10
MA-5416BX	Size 16, 3/4" - 1-1/2" Dia	10
MA-5420BX	Size 20, 3/4" - 1-3/4" Dia	10
MA-5428BX	Size 28, 1-5/16" - 2-1/4" Dia	10
MA-5432BX	Size 32, 1-9/16" - 2-1/2" Dia	10
MA-56188	Size 188, 11" - 12" Dia	10

MICRO GEAR HOSE CLAMP

1/4" Hex head
300 Stainless band and housing
Zinc-plated carbon steel screw
Tiny—Tough with only
10 inch-pounds
of screw torque



Part	Description	Box Qty
MA-6202BX	Size 04, 1/4" - 5/8" Dia.	10
MA-6203BX	Size 06, 5/16" - 7/8" Dia	10
MA-6204BX	Size 12, 5/8" - 1-1/4" Dia	10
MA-6205BX	Size 16, 5/8" - 1-1/2" Dia	10
MA-6206BX	Size 20, 3/4" - 1 3/4" Dia	10

AUXILIARY CONDENSATE PANS WASHING MACHINE PANS WATER HEATER PANS

Hot water heater pans, made from tough, durable plastic. Easy to install. Will not leak. Rustproof, one piece construction. Predrilled, 1" drain fitting included.

Washing machine pan for long lasting protection from washing machine failure! Easy to install 1" plastic drain fitting (included). Can be hooked up for side outlet drain. Rustproof, high impact plastic. This unique drain pan fits under the washer to protect against water overflow. or hose failure. Protects floors and carpets.

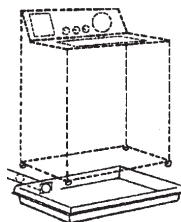

MA-WP1

MA-WHP22
MA-WHP24
MA-WHP26
MA-WHP28
MA-WHP32

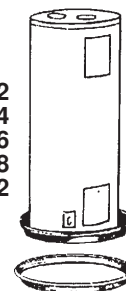

Part	Description	Pkg
MA-CP1	Auxiliary Condensate Pan 28-3/4" x 33-3/4"	5
MA-CP2	Auxiliary Condensate Pan 17" x 39-3/4"	5
MA-WHP22	Water Heater Pan 20" - 22" o.d. dia.	20
MA-WHP24	Water Heater Pan 22" - 24" o.d. dia	20
MA-WHP26	Water Heater Pan 24" - 26" o.d. dia	20
MA-WHP28	Water Heater Pan 26" - 28" o.d. dia	20
MA-WHP32	Water Heater Pan 30" - 32" o.d. dia	6
MA-WP1	Washing Machine Pan 29" x 27" I.D.	10

CONDENSATE TRAPS

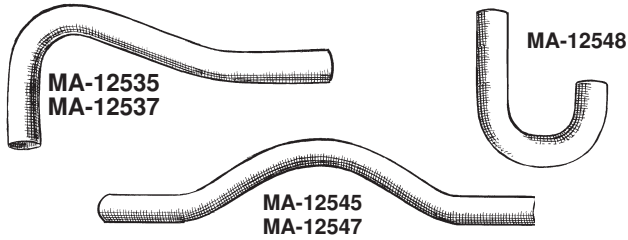

Part	Description
MA-12535	1/2" Sch 40 600 psi PVC P-trap
MA-12537	3/4" Sch 40 480 psi PVC P-trap
MA-12545	1/2" Sch 40 600 psi PVC R-trap
MA-12547	3/4" Sch 40 480 psi PVC R-trap
MA-12548	3/4" Sch 40 480 psi PVC J-trap

TEFLON THREAD SEAL



MA-Line offers more value with our new Teflon brand tape. high quality thread seal tape.

Size: 1/2" x520"

48 in a Display Case.

Part	Description
MA-C950	Teflon Tape Thread Seal
MA-C950-4	Teflon Tape 4 per Package

PVC CEMENT



ALL PURPOSE CEMENT

Heavy bodied clear cement for use on ABS, PVS, PVC, or CPVC pipe & fittings. Flows freely & provides a thick layer of cement on the pipe. Exceeds ASTM D-2564, D-2846, D-2235, F-493. Application temperature: 40°F to 100°F



REGULAR CLEAR CEMENT

for PVC pipe & fittings, up to 4" Sch. 40 & up to 2" for Sch.80 potable water pressure pipe, gas conduit, drain waste & vent pipe. Apply at temperatures for 40°F to 100°F.



CLEAR ALL WEATHER CEMENT

For PVC pipe, good in all types of weather.

REGULAR CEMENT FOR PVC PIPE AND FITTINGS

Part	Description	Case Qty.
MA-31012	4 oz. can	24
MA-31013	8 oz. can	24
MA-31014	16 oz. can	24
MA-31015	32 oz. can	12

ALL PURPOSE CEMENT FOR ABS, PVC, CPVC

MA-30818	4 oz. can	24
MA-30821	8 oz. can	24
MA-30834	16 oz. can	24
MA-30847	32 oz. can	12

ALL WEATHER PVC CEMENT

MA-31132	16 oz. can	24
MA-31133	32 oz. can	12

PVC PIPE CUTTER RATCHET STYLE PIPE CUTTERS

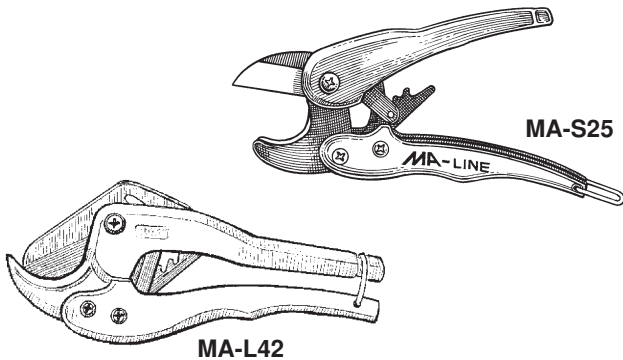

Part	Description
MA-S25	Cuts up to 1"
MA-S25RB	Blade for MA-S25
MA-L42	Cuts up to 1-1/4"
MA-L42RB	Blade for MA-L42
MA-L50	Cuts up to 2"
MA-L50RB	Blade for MA-L50

WIRE PVC CUTTER/SAW

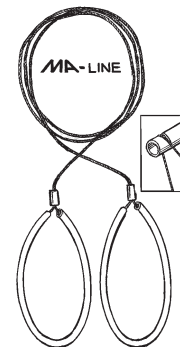

These new wire PVC cutters are easy, inexpensive and convenient to use. They are durable and come in two different lengths. The 27" length is for smaller sizes of PVC pipe, and the 42" length makes it easy to cut the large (4" and up) size PVC.

Part	Description
MA-PVC27	27" Wire PVC Cutter
MA-PVC42	42" Wire PVC Cutter

SCH 40 PVC FITTINGS

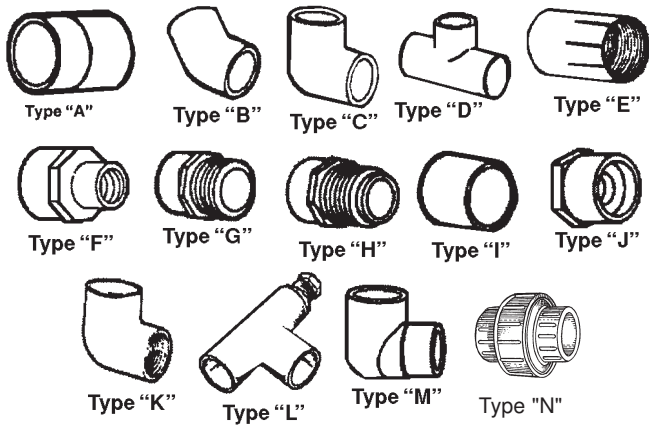

Part	Description	Pkg	Type
MA-30105	Coupling-1/2" slip x slip	100	A
MA-30107	Coupling-3/4" slip x slip	50	A
MA-30110	Coupling-1" slip x slip	50	A
MA-30605	Elbow 45-1/2" slip x slip	50	B
MA-30607	Elbow 45-3/4" slip x slip	50	B
MA-30610	Elbow 45-1" slip x slip	50	B
MA-30705	Elbow 90-1/2" slip x slip	50	C
MA-30707	Elbow 90-3/4" slip x slip	50	C
MA-30710	Elbow 90-1" slip x slip	50	C
MA-31318	1/2" Clean Out Tee	1	L
MA-31348	3/4" Clean Out Tee	1	L
MA-31405	Tee-1/2" slip x slip x slip	50	D
MA-31407	Tee-3/4" slip x slip x slip	50	D
MA-31410	Tee-1" slip x slip x slip	50	D
MA-30305	Adaptor-1/2" slip x fpt	100	E
MA-30307	Adaptor-3/4" slip x fpt	50	E
MA-30311	Adaptor-1" slip x fpt	50	E
MA-30357	Reducing fpt adaptor 1/2" slip x 3/4" fpt	50	F
MA-30405	Adaptor-1/2" slip x mpt	100	G
MA-30407	Adaptor-3/4" slip x mpt	50	G
MA-30410	Adaptor-1" slip x mpt	50	G
MA-30457	Reducing mpt adaptor 1/2" slip x 3/4" mpt	50	H
MA-30155	Cap-1/2" slip	100	I
MA-30157	Cap-3/4" slip	100	I
MA-30158	Cap-1" slip	50	I
MA-30275	Reducing bushing 3/4" slip x 1/2" slip	100	J
MA-437131	Reducing bushing 1" slip x 3/4" slip	100	J
MA-436074	Adaptor Reducing 1/2" mpt x 3/4" slip	50	J
MA-448007	Cap 3/4" fpt	100	
MA-450007	Plug 3/4" mpt	50	
MA-32905	Street Ell 90-1/2" slip	50	M
MA-32907	Street Ell 90-3/4" slip	50	M
MA-409010	Street Ell 90-1" slip	50	M
MA-33905	Elbow 90-1/2" slip x fpt	50	K
MA-33907	Elbow 90-3/4" slip x fpt	50	K
MA-33910	Elbow 90-1" slip x fpt	50	K
MA-401020	Tee-2" slip x slip x slip	25	D
MA-407074	Elbow 90-3/4" fpt x 1/2" slip	50	K
MA-410005	Street Ell 90° 1/2" mpt x 1/2" slip	50	M
MA-410007	Street Ell 90° 3/4" mpt x 3/4" slip	50	M
MA-410010	Street Ell 90° 1" mpt x 1" slip	50	M
MA-410101	Street Ell 90° 3/4" mpt x 1/2" slip	50	M
MA-457005	Union-1/2" slip x slip	10	N
MA-457007	Union-3/4" slip x slip	10	N
MA-457010	Union-1" slip x slip	10	N
MA-457012	Union-1-1/4" slip x slip	5	N
MA-457015	Union-1-1/2" slip x slip	5	N
MA-457020	Union - 2" slip x slip	2	N

SCH 40 PVC-DWV FITTINGS

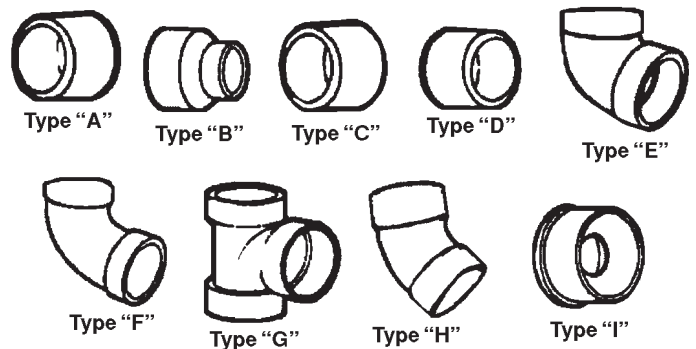

Part	Description	Pkg	Type
MA-70115	1-1/2" Coupling	100	A
MA-70120	2" Coupling	100	A
MA-429025	2 1/2 Sch 40 Coupling	10	A
MA-70130	3" Coupling	60	A
MA-D100040	4" Coupling	25	A
MA-70121	2" x 1-1/2" Reducing Coupling	25	B
MA-70132	3" x 2" Reducing Coupling	20	B
MA-D102420	4" x 2" Reducing Coupling	10	B
MA-D102422	4" x 3" Reducing Coupling	10	B
MA-70116	1-1/2" Repair Coupling	25	C
MA-70122	2" Repair Coupling	25	C
MA-70133	3" Repair Coupling	10	C
MA-D130040	4" Repair Coupling	5	C
MA-70151	1-1/2" Cap Sch 40	25	D
MA-70152	2" Cap Sch 40	25	D
MA-447025	2-1/2" Sch 40 Cap	10	D
MA-70153	3" Cap Sch 40	10	D
MA-447040	4" Cap Sch 40	5	D
MA-72815	1-1/2" 90° Ell	100	E
MA-72820	2" 90° Ell	50	E
MA-406025	2-1/2" Sch 40 90° Ell	10	E
MA-72830	3" 90° Ell	25	E
MA-D300040	4" 90° Ell	10	E
MA-70615	1-1/2" 45° Ell	100	H
MA-70620	2" 45° Ell	50	H
MA-417025	2-1/2" Sch 40 45° Ell	10	H
MA-70630	3" 45° Ell	20	H
MA-D321040	4" 45° Ell	10	H
MA-73815	1-1/2" Long Sweep 90° Ell	50	F
MA-73820	2" Long Sweep 90° Ell	25	F
MA-73830	3" Long Sweep 90° Ell	10	F
MA-D304040	4" Long Sweep 90° Ell	5	F
MA-71115	1-1/2" DWV, Tee	100	G
MA-71120	2" Tee	35	G
MA-401025	2-1/2" Sch 40 Tee	10	G
MA-71130	3" Tee	30	G
MA-D400040	4" Tee	5	G
MA-70221	2" x 1-1/2" Bushing Sch 40	50	I
MA-437292	2-1/2" x 2" Sch 40 Bushing	10	I
MA-70231	3" x 1-1/2" Bushing Sch 40	30	I
MA-70232	3" x 2" Bushing	30	I
MA-437339	3" x 2-1/2" Sch 40 Bushing	10	I
MA-D309015	1-1/2" Long Sweep Street Elbow	10	
MA-D309020	2" Long Sweep Street Elbow	25	
MA-D309030	3" Long Sweep Street Elbow	20	
MA-D323015	1-1/2" 45 deg. Street Elbow	100	
MA-D323020	2" 45 deg. Sweep Street Elbow	50	
MA-D323030	3" 45 deg. Sweep Street Elbow	20	
MA-207013	3/4" x CL TBE Sch 80 Nipple	50	
MA-207030	3/4" x 3" TBE Sch 80 Nipple	50	

MALLEABLE BLACK IRON PIPE FITTINGS

CLASS 150



TEE



REDUCING TEE



PLUG



90 STREET ELBOW



45 ELBOW



90 ELBOW



COUPLING



UNION



BUSHING



REDUCING COUPLING

SPECIFICATIONS:

Material: ASTM A-197

Dimensions: ANSI B16.3 & ANSI B16.14

Threads: ANSI B1.20.1

Part	Description	Ctn
MA-12U	1/2" Union	20
MA-34U	3/4" Union	35
MA-1U	1" Union	20
MA-12CPLG	1/2" Coupling	40
MA-34CPLG	3/4" Coupling	50
MA-1CPLG	1" Coupling	25
MA-3412CPLG	3/4" x 1/2"	60
	Reducing Coupling	
MA-112CPLG	1" x 1/2"	30
	Reducing Coupling	
MA-134CPLG	1" x 3/4"	25
	Reducing Coupling	
MA-1290EL	1/2" 90 Ell	50
MA-3490EL	3/4" 90 Ell	35
MA-190EL	1" 90 Ell	20
MA-1245EL	1/2" 45 Ell	50
MA-3445EL	3/4" 45 Ell	40
MA-145EL	1" 45 Ell	20
MA-1290STEL	1/2" 90 St. Ell	50
MA-3490STEL	3/4" 90 St. Ell	35
MA-190STEL	1" 90 Ell	30
MA-12T	1/2" T	40
MA-34T	3/4" T	35
MA-1T	1" T	20
MA-341212T	3/4" x 1/2" x 1/2" T	30
MA-343412T	3/4" x 3/4" x 1/2" T	30
MA-1238BG	1/2" x 3/8" Hex bush	100
MA-3412BG	3/4" x 1/2" Hex bush	50
MA-112BG	1 x 1/2" Hex bush	50
MA-134BG	1" x 3/4" Hex bush	50
MA-12CAP	1/2" Cap	50
MA-34CAP	3/4" Cap	40
MA-1CAP	1" Cap	25
MA-12PLG	1/2" Solid Plug	50
MA-34PLG	3/4" Solid Plug	30
MA-1PLG	1" Solid Plug	20

WELDED STEEL BLACK IRON PIPE NIPPLES

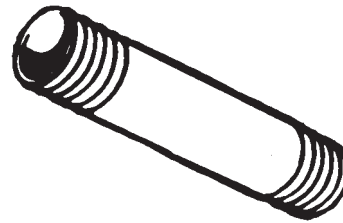

SPECIFICATIONS:

Pipe Nipples meet the ASTM A733 Specifications.

Part	Description	Ctn
MA-BN12CL	1/2" x CL-1-1/8"	25
MA-BN12112	1/2" x 1-1/2"	25
MA-BN122	1/2" x 2"	25
MA-BN12212	1/2" x 2-1/2"	25
MA-BN123	1/2" x 3"	25
MA-BN12312	1/2" x 3-1/2"	25
MA-BN124	1/2" x 4"	25
MA-BN12412	1/2" x 4-1/2"	25
MA-BN125	1/2" x 5"	25
MA-BN12512	1/2" x 5-1/2"	25
MA-BN126	1/2" x 6"	25
MA-BP1212	1/2" x 12"	1
MA-BP1218	1/2" x 18"	1
MA-BP1224	1/2" x 24"	1
MA-BP1230	1/2" x 30"	1
MA-BP1236	1/2" x 36"	1
MA-BP1248	1/2" x 48"	1
MA-BP1260	1/2" x 60"	1
MA-BN34CL	3/4" x CL1-3/8"	25
MA-BN34112	3/4" x 1-1/2"	25
MA-BN342	3/4" x 2"	25
MA-BN34212	3/4" x 2-1/2"	25
MA-BN343	3/4" x 3"	25
MA-BN34312	3/4" x 3-1/2"	25
MA-BN344	3/4" x 4"	25
MA-BN34412	3/4" x 4-1/2"	25
MA-BN345	3/4" x 5"	25
MA-BN34512	3/4" x 5-1/2"	25
MA-BN346	3/4" x 6"	25
MA-BP3412	3/4" x 12"	1
MA-BP3418	3/4" x 18"	1
MA-BP3424	3/4" x 24"	1
MA-BP3430	3/4" x 30"	1
MA-BP3436	3/4" x 36"	1
MA-BP3448	3/4" x 48"	1
MA-BP3460	3/4" X 60"	1
MA-BN1CL	1" x CL 1-1/2"	25
MA-BN12	1" x 2"	25
MA-BN1212	1" x 2-1/2"	25
MA-BN13	1" x 3"	25
MA-BN1312	1" x 3-1/2"	25
MA-BN14	1" x 4"	25
MA-BN1412	1" x 4-1/2"	25
MA-BN15	1" x 5"	25
MA-BN1512	1" x 5-1/2"	25
MA-BN16	1" x 6"	25
MA-BP112	1" x 12"	1
MA-BP118	1" x 18"	1
MA-BP124	1" x 24"	1
MA-BP130	1" x 30"	1
MA-BP136	1" x 36"	1
MA-BP148	1" x 48"	1
MA-BP160	1" x 60"	1

ASSORTED NIPPLE CARDBOARD TOTE TRAYS

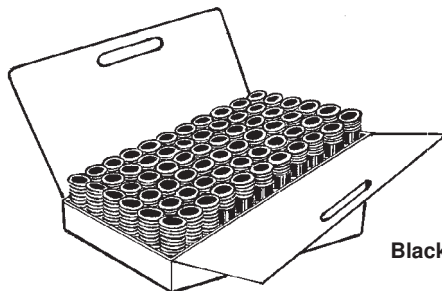

Black Iron Nipple

Ma-Line Tote Trays are packed with quality nipples manufactured from new mill tested pipe and conform with commercial standards CS-5-65 of the National Bureau of Standards, U.S. Dept. of Commerce.

The 1/2" Tote Tray contains a total of 66 pieces. (6 each of the following lengths) Close, 1-1/2", 2", 2-1/2", 3", 3-1/2", 4", 4-1/2", 5", 5-1/2", & 6".

Part # MA-1266T

The 3/4" Tote Tray contains a total of 66 pieces. (6 each of the following lengths) close, 1-1/2", 2", 2-1/2", 3", 3-1/2", 4", 4-1/2", 5", 5-1/2", & 6".

Part # MA-3466T

The 1" Tote Tray contains a total of 60 pieces. (6 each of the following lengths) Close, 2", 2-1/2", 3", 3-1/2", 4", 4-1/2", 5", 5-1/2", & 6".

Part # MA-0160T

Part	Description	Per Ctn
MA-1266T	1/2" TRAY	4
MA-3466T	3/4" TRAY	4
MA-0160T	1" TRAY	4

SILICONE CAULK



Waterproofs, weatherproofs, FDA approved, permanently flexible, -60°F to +450°F, insulates, resealable. Meets FDA/USDA requirements for use in establishments operating under Federal Meat & Poultry Inspection Program. CFR 177.2600

Part	Description
MA-SSC-CK	Clear
MA-SSA-CK	Almond
MA-SSG-CK	Gray
MA-SSB-CK	Bronze
MA-SSW-CK	White

FIRE STOPPING PRODUCTS

LATEX FIRESTOP SEALANT



For all forms of pipe in ceiling or floors. All plastic, insulated and metal pipes. Carries all UL ratings and is factory mutual approved.

Expands to 8 times its size when subjected to high heat and flame..

Part	Description
MA-SSS100	Latex Sealant, 10.5 oz. Tube

NIPPLE TRAY

Made of high impact plastic, drain holes in the bottom lets caddy drain. Bottom design holds nipples and will keep them out of water & other liquids.

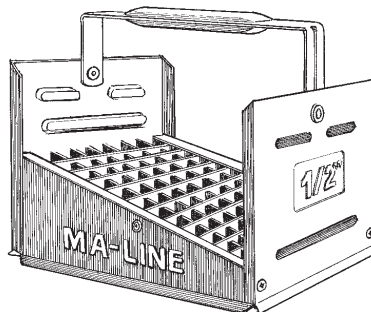
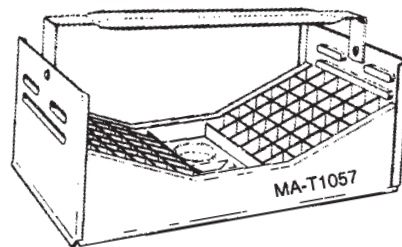

Withstands harsh chemicals, acids and oils. When bent or crushed, will spring back into shape leaving no permanent damage.

Part	Description
MA-T1005	1/2" Tray
MA-T1007	3/4" Tray
MA-T1010	1" Tray
MA-T1057	1/2" & 3/4"

HIGH TEMP RED SILICONE CAULK



Waterproofs, weatherproofs, FDA approved, permanently flexible, -84°F to +500°F, insulates thermally and electrically. Resealable. Meets FDA/USDA requirements for use in establishments operating under Federal Meat & Poultry Inspection Program. CFR 177.2600

FORMULATED TO PERFORM AT TEMPERATURES RANGING FROM -84°F TO +500°F (-65°C TO +260°C) FOR CONTINUOUS OPERATION & TO +600°F (+316°C) FOR INTERMITTENT EXPOSURE.

Sold by Case of 12/Price per Each

Part	Description
MA-HTSS-R	High Temp Red Silicone Caulk

CAULKING GUNS

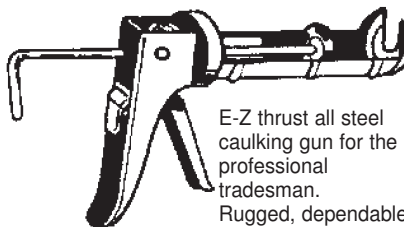

MA-101

E-Z thrust all steel caulk gun for the professional tradesman. Rugged, dependable and economical!

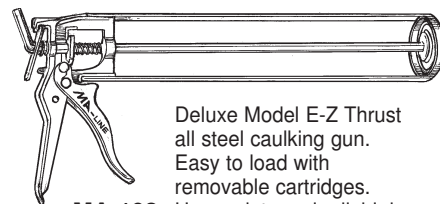

MA-102

Deluxe Model E-Z Thrust all steel caulk gun. Easy to load with removable cartridges. Heavy duty and reliable!

Part	Description
MA-101	E/Z Thrust Caulking Gun, All Steel
MA-102	Heavy Duty Deluxe Caulking Gun, All Steel

PIPE JOINT COMPOUND WITH TEFLON

A white, non-hardening, non-separating Teflon paste seals all threaded connections against leakage for internal pressure. Withstands 10,000 PSI at -100°F to 600°F, and formulated for use on water steam, natural and LP gas, oil, caustics, or dilute acid lines. Can also be used with PVC, CPVC, ABS, Cyclocac, Polypropylene, iron, steel or copper threads. Do not use on oxygen, fluorine, or molten metal lines.



Package with a brush top applicator.

Part	Description	Per Cs
MA-31229	1 fl.oz. Tube Pipe Compound with Teflon	12
MA-31230	4 fl.oz. Pipe Joint Compound with Teflon with brush	12
MA-31231	8 fl.oz. Pipe Joint Compound with Teflon with brush	12

PIPE JOINT COMPOUND



A fast set non-hardening paste which lubricates and seals threaded joints. Non-toxic and may be used on water, natural gas, stem and air lines. Perfect for applying gaskets to flanges.

Packaged with a brush top applicator.

Part	Description	Per Cs
MA-31226	1 fl.oz. Tube Pipe Joint Compound	12
MA-31227	4 fl.oz. Pipe Joint Compound w/Brush	12
MA-31228	8 fl.oz. Pipe Joint Compound w/Brush	12

SEALGUM

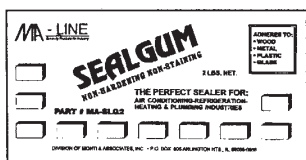

FEATURES:

- Non hardening putty for sealing around copper tube openings.
- Available in 2 sizes: 1 and 2 pound packages.

Part	Description	Per/Ctn
MA-SLG1	1 lb. Sealgum	24
MA-SLG2	2 lb Sealgum	24

WHITE SMOKE CARTRIDGES



Ideal for testing leaks in duct work, heat exchanger, furnaces. Pressure test chimneys. Also great to test air movement and ventilation system.

Sold by the Standard Package

Part	Description	Per/Ctn
MA-SC150CF	45 sec/150 cu. ft	10
MA-SC600CF	90 sec./600 cu. ft.	10
MA-SC1200CF	4 minute/1200 cu. ft.	5
MA-SC5000CF	5 minute/2500 cu. ft.	5

CORK & FOAM TAPE



MA-CT1



MA-FT1

FEATURES:

- Adheres firmly to all metals.
- Can be used on hot or cold pipes to stop condensation or drips.
- Supplied on easy to use roll.

FEATURES:

- Superior self-adhesive foam insulating tape.
- Can be used on hot and cold pipes.
- Prevents condensation and dripping.
- Easily cut and molded.
- Works well around valves and fittings.

Part	Description	Per/Ctn
MA-CT1	1/8" X 2" X 30 ft. Cork	12
MA-FT1	1/8" x 2" X 30 ft Foam	12

SEALGUM CORDS

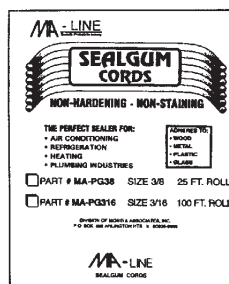

FEATURES:

- Non hardening putty.
- Ideal for sealing around window air conditioners and plugging tube openings through foundations.
- Available in 2 sizes.

Part	Description	Per/Ctn
MA-PG316	3/16" x 100 ft. Sealgum Cord	12
MA-PG38	3/8" x 25 ft. Sealgum Cord	12

GRAY SMOKE CARTRIDGES

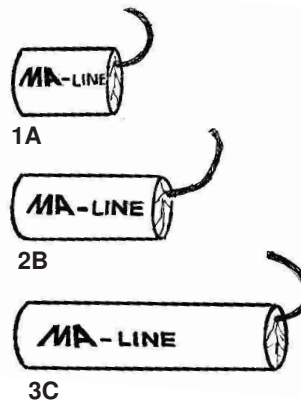

Ideal for testing leaks in duct work, heat exchanges, furnaces. Pressure test chimneys. Also great to test air movement and ventilation system. \Smoke varies in color from white to gray depending upon density and lighting.

Part	Description	Per/Ctn
1A	30 second/4000 cu. ft.	12
2B	1 minute/8000 cu. ft.	12
3C	3 minute/40,000 cu. ft.	12

PLATED SHEET METAL SCREWS

UNSLOTTED HEX WASHER HEAD
SELF DRILLING SCREWS



Part	Size	
MA03758-1	8x1/2	20 (bag)
MA03759-1	8x3/4	18 (bag)
MA03760-1	8x1	16 (bag)
MA03761-1	10x1/2	14 (bag)
MA03762-1	10x3/4	12 (bag)
MA03763-1	10x1	10 (bag)
BAGS-100PCS		
MA03758-2	8x1/2	
MA03759-2	8x3/4	
MA03760-2	8x1	
MA03761-2	10x1/2	
MA03762-2	10x3/4	
MA03763-2	10x1	
TUBS-500PCS		
MA03758-3	8x1/2	
MA03759-3	8x3/4	
MA03760-3	8x1	
MA03761-3	10x1/2	
MA03762-3	10x3/4	
MA03763-3	10x1	

PLATED SHEET METAL SCREWS

FAST PENETRATING, SLOTTED, HEX
WASHER HEAD SCREWS



Part	Size
BAGS-100PCS	
MA03413-2	6x3/8
MA03414-2	7x1/2
MA03415-2	8x1/2
MA03416-2	8x3/4
MA03417-2	10x1/2
MA03565-2	8x1
MA03566-2	10x3/4
MA03567-2	10x1
TUBS-1000PCS	
MA03413-4	6x3/8
MA03414-4	7x1/2
MA03415-4	8x1/2
MA03416-4	8x3/4
MA03417-4	10x1/2
MA03566-4	10x3/4
TUBS-500PCS	
MA03565-3	8x1
MA03567-3	10x1

PERFORATED STRAP: GALVANIZED AND COPPER

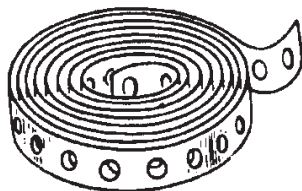

Part	Description
MA-GF1	20 Ga. Galvanized Strap 3/4" x 10'
MA-GF-50	20 Ga. Galvanized Strap 3/4" x 50'
MA-GF-100	20 Ga. Galvanized Strap 3/4" x 100'
MA-CF1	20 Ga. Copper Strap 3/4" x 10'
MA-CF-50	20 Ga. Copper Strap 3/4" x 50'
MA-CF-100	20 Ga. Copper-Plated Strap 3/4" x 100'

PLASTIC HANGER STRAP

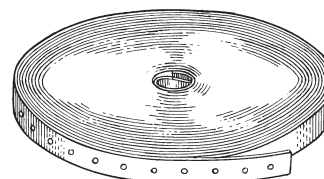

USES:

- Pipe Hanger
- Duct Hanger
- Tubing Strap
- Utility Strap

Part	Description
MA-PH50	3/4" x 50' Plastic Hanger Strap
MA-PH100	3/4" x 100' Plastic Hanger Strap

ADJUSTABLE SWIVEL J-HOOK HANGER

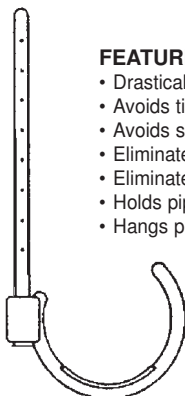

FEATURES:

- Drastically reduces installation time.
- Avoids time consuming measuring and adjusting.
- Avoids soldering wire hangers.
- Eliminates noisy, banging pipes.
- Eliminates hanger/pipe corrosion and electrolysis.
- Holds pipe firmly.
- Hangs pipe on angles with ease turning rotating features.

Part	Description
MA-SH1500	1-1/2" Swivel Hanger
MA-SH2000	2" Swivel Hanger
MA-SH3000	3" Swivel Hanger
MA-SH4000	4" Swivel Hanger

J-HOOK PIPE HOLDERS WITH NAILS INCLUDED



DRAIN PIPE HOLDERS

Part	Description
MA-J1500	Drain Pipe Holder 1-1/2" x 7-1/2"
MA-J2000	Drain Pipe Holder 2" x 7-1/2"
MA-J3000	Drain Pipe Holder 3" x 7-1/2"
MA-J4000	Drain Pipe Holder 4" x 7-1/2"

HANGING WIRE

WIRE GAUGE: 18
FOR GALVANIZED AND BLACK ANNEALED

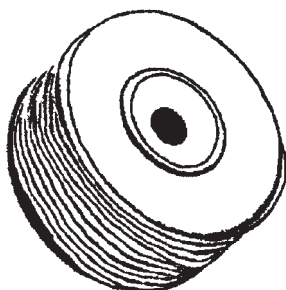

Part	Description
MA-HWA02	2 lb. Black Annealed Wire
MA-HWA05	5 lb. Black Annealed Wire
MA-HWG02	2 lb. Galvanized Wire
MA-HWG05	5 lb. Galvanized Wire

1-HOLE PIPE CLAMPS

TO BE USED WHEN HANGING THINWALL/CONDUIT
CONDUIT PIPE CLAMPS

TO BE USED WHEN HANGING CONDUIT OR IRON PIPE

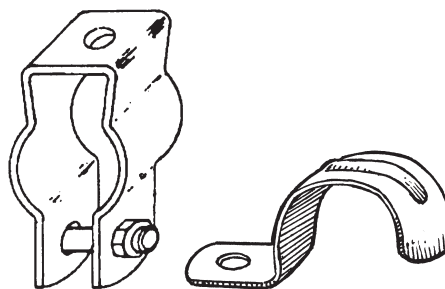

1-HOLE GALVANIZED PIPE CLAMPS

Part	Size	Std. Pkg.
MA-DT12	1/2" I.D.	100
MA-DT34	3/4" I.D.	100
MA-DT1	1" I.D.	50
MA-DT114	1-1/4" I.D.	25
MA-DT112	1-1/2" I.D.	25
MA-DT2	2" I.D.	25
MA-10DT12	1/2" I.D.	10
MA-10DT34	3/4" I.D.	10
MA-5DT1	1" I.D.	5
MA-5DT114	1-1/4" I.D.	5
MA-5DT112	1-1/2" I.D.	5

CONDUIT PIPE CLAMPS WITH BOLTS

Part	Size	Std. Pkg.
MA-K12	1/2" I.D.	50
MA-K34	3/4" I.D.	50
MA-K1	1" I.D.	50
MA-K114	1-1/4" I.D.	25
MA-K112	1-1/2" I.D.	25
MA-K2	2" I.D.	25
MA-K212	2-1/2" I.D.	10
MA-K3	3" I.D.	10

ROUND HEAD STOVE BOLTS w/NUTS

MA-KNB25	1/4 x 1-1/4 Rd	25
	Stove bolts & Nuts	
MA-KNB50	1/4 x 1-1/4 Rd	50
	Stove bolts & Nuts	

WIRE PIPE HANGERS

IDEAL FOR HANGING
BLACK IRON PIPE
#9 Gauge Wire



Standard Package/50 Hangers per box

Part	Description
MA-NW124	1/2" x 4"
MA-NW126	1/2" x 6"
MA-NW128	1/2" x 8"
MA-NW1210	1/2" x 10"
MA-NW344	3/4" x 4"
MA-NW346	3/4" X 6"
MA-NW348	3/4" X 8"
MA-NW3410	3/4" X 10"
MA-NW14	1" X 4"
MA-NW16	1" X 6"
MA-NW18	1" X 8"
MA-NW110	1" X 10"
MA-NW1146	1-1/4" X 6"
MA-NW1148	1-1/4" X 8"
MA-NW11410	1-1/4" X 10"
MA-NW1126	1-1/2" X 6"
MA-NW1128	1-1/2" X 8"

WIRE PIPE HANGERS COPPER COATED STEEL

WIRE GAUGE: 9
SUITABLE FOR HANGING COPPER TUBING

Standard Package/50 Hangers per box

Part	Description
MA-NW124-C	1/2" x 4"
MA-NW126-C	1/2" x 6"
MA-NW128-C	1/2" x 8"
MA-NW344-C	3/4" x 4"
MA-NW346-C	3/4" X 6"
MA-NW348-C	3/4" X 8"
MA-NW14-C	1" X 4"
MA-NW16-C	1" X 6"
MA-NW18-C	1" X 8"
MA-NW1146-C	1-1/4" X 6"
MA-NW1148-C	1-1/4" X 8"
MA-NW1126-C	1-1/2" X 6"
MA-NW1128-C	1-1/2" X 8"

2-HOLE COPPER TUBING CLAMP

IDEAL FOR HANGING COPPER TUBING
GALVANIZED PIPE CLAMPS
TO BE USED WHEN HANGING
THINWALL CONDUIT

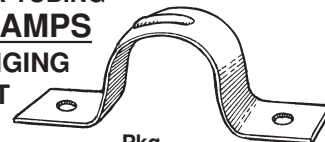

Part	Description	Pkg
MA-BC14	Copper 1/4" I.D.	100/Bag
MA-BC38	Copper 3/8" I.D.	100/Bag
MA-BC12	Copper 1/2" I.D.	100/Bag
MA-BC34	Copper 3/4" I.D.	100/Bag
MA-BC1	Copper 1" I.D.	100/Bag
MA-BC114	Copper 1-1/4" I.D.	100/Box
MA-BC112	Copper 1-1/2" I.D.	100/Box
MA-BC2	Copper 2" I.D.	100/Box
MA-BT14	Galvanized 1/4" I.D.	100/Box
MA-BT38	Galvanized 3/8" I.D.	100/Box
MA-BT12	Galvanized 1/2" I.D.	100/Box
MA-BT34	Galvanized 3/4" I.D.	100/Box
MA-BT1	Galvanized 1" I.D.	100/Box
MA-BT114	Galvanized 1-1/4" I.D.	50/Box
MA-BT112	Galvanized 1-1/2" I.D.	25/Box
MA-BT2	Galvanized 2" I.D.	25/Box

DUE TO THE INCREASED FLUCTUATION IN THE METALS MARKET, PRICES MAY CHANGE WITHOUT NOTICE.

28 LEDS TRI BEAM FLASHLIGHT

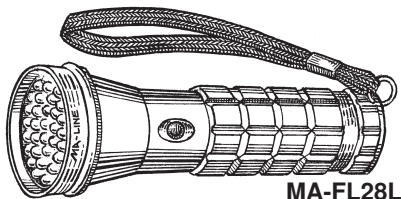

MA-FL28L

FEATURES:

- Aluminum Alloy Body
- Nylon Pouch with Belt Strap
- Low Power Consumption
- 3 AAA Batteries included

Part	Description
MA-FL28L	28/ LEDSTri Beam Flashlight

FLEXIBLE NECK 4 LEDS FLASHLIGHT

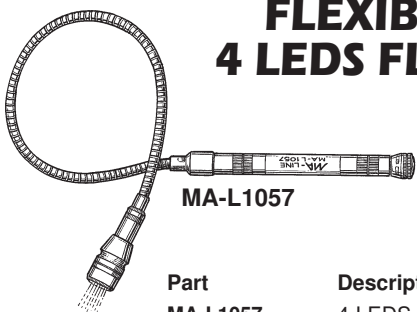

MA-L1057

FEATURES:

- Overall Length 32"
- Flexible Neck 20" Long
- Batteries: 3 AA's

Part	Description
MA-L1057	4 LEDS Flashlight with Flexible Neck

MAGLIGHT FLASHLIGHTS



Part	Description
MA-RX1019	Rechargeable Mag Kit

Rechargeable Mag Kit includes: Flashlight, Battery Pack, Charging Unit, Mounting Bracket, 110V AC Converter, and 12V DC Cigarette Lighter Adaptor.

FOR REPLACEMENT BULBS & HOLSTERS SEE PAGE 65

Part	Description
MA-K3A016	Solitaire AAA Flashlight
MA-M2A016	Mini-Maglight AA Flashlight
MA-M2A01H	Holster Combo Pack
MA-M3A016	Mini Maglight AAA Flashlight
MA-S2C016	2 Cell C Maglight Flashlight
MA-S2D016	2 Cell D Maglight Flashlight
MA-S3C016	3 Cell C Maglight Flashlight
MA-S3D016	3 Cell D Maglight Flashlight
MA-S4C016	4 Cell C Maglight Flashlight
MA-S4D016	4 Cell D Maglight Flashlight
MA-S5D016	5 Cell D Maglight Flashlight



5 LEDS / 8 LEDS / 9 LEDS FLASHLIGHT



MA-0620

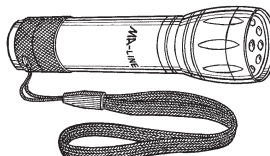

MA-FL13089

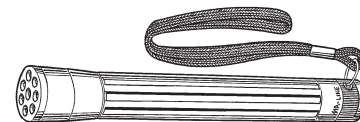

MA-502N-8L

FEATURES:

- Impact-Resistant Rigid Aluminum Alloy Body
- Energy Saving and Durability
- Water Resistant
- Pouch Included

Part	Description
MA-0620	5 LEDS Flashlight Includes: 1 AA Battery and Nylon Pouch
MA-502N-8L	8 LEDS Flashlight Includes: 2 AA Batteries and Nylon Pouch
MA-FL13089	9 LEDS Flashlight Includes: 3 AA Batteries

24 LEDS / 32 LEDS / 72 LEDS WORKLIGHTS WITH HOOK AND MAGNETS

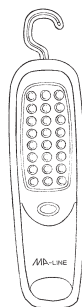

MA-FL24LEDA



MA-FL32LED

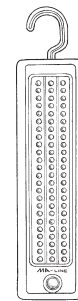

MA-WL72LED

Part	Description
MA-FL24LEDA	24 LEDS Worklight
MA-FL32LED	32 LEDS Worklight
MA-WL72LED	72 LEDS Worklight

7 LEDS HEAD LAMP

- Hands Free Convenience
- 3 positions: 1-3-7LED
- Batteries Included

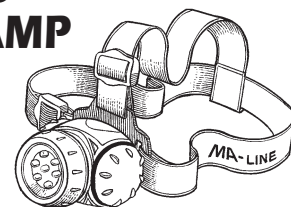

Part	Description
MA-HML7	7 LEDS Head Lamp

1 WATT LED FLASHLIGHT 3 WATT LED FLASHLIGHT

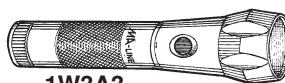

1W3A3



K23W3A6

Part	Description
1W3A3	1 Watt LED Flashlight with Intermittent Signal Includes: 3 AAA Batteries and a Nylon Pouch.
K23W3A6	3 Watt LED Flashlight with High & Low Beam Switch Includes: 6 AAA Batteries and a Nylon Pouch.

MAGNA-LITE

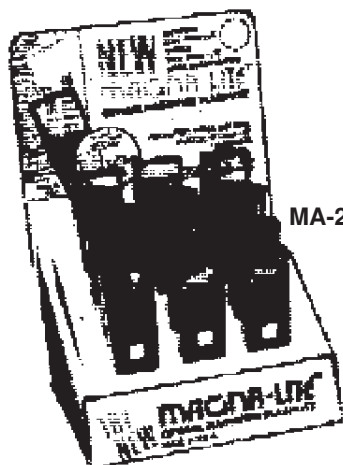

MA-2001



Sold by the carton of 12

Part	Description	ctn. qty
MA-1001	Magna-Lite Jr.	12
MA-2001	Magni-Lite Sr.	1
Part	Description	
MA-4001	Bulb & Battery Replacement Pack for #1001	

INDUSTRIAL MULTI-PACK BATTERIES



Part	Description
MA-ALD	D Industrial Grade Alkaline 6 per package/72 batteries per case
MA-ALC	C Industrial Grade Alkaline 6 per package/72 batteries per case
MA-ALAA	AA Industrial Grade Alkaline 8 per package/96 batteries per case
MA-ALAAA	AAA Industrial Grade Alkaline 8 per package/96 batteries per case
MA-AL9V	9V Industrial Grade Alkaline 6 per package/72 batteries per case

MAGLIGHT HOLSTERS



Part	Description
MA-AM2A026	Plain Leather Holster AA
MA-AM2A056	Nylon Full Flap Holster AA
MA-AM3A026	Nylon Full Flap Holster AAA
MA-ASXC046	Plain Leather Belt Holder C Cell
MA-ASXD036	Plain Leather Belt Holder D Cell

MAGNETIC 180° ADJUSTABLE METAL WORKLIGHT WITH 25 FOOT CORD

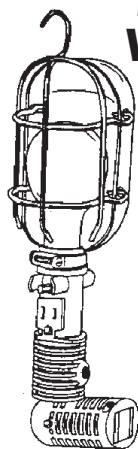

Powerful magnetic casework light designed to light hard-to-reach areas. Powerful magnet will hold approximately 50 lbs. on any metal surface. In addition, has unique ability to reposition the swiveling lamp head by 180°. Sturdy metal lamp guard; 3-wire grounding outlet. Maximum light bulb 75 watts.

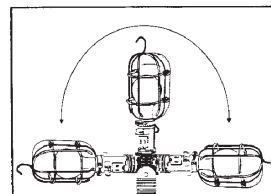

Unique 180° positioning

Part	Description
MA-748325A	Magnetic, 180° Adjustable Metal Worklight with 25 ft. Cord

TROUBLE LIGHTS

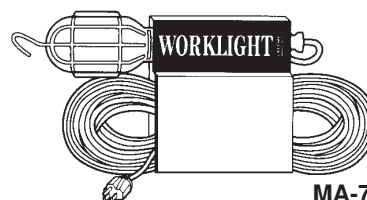

MA-71493
MA-70343

Part	Description
MA-71493	25 ft. 16/3 SJT Trouble Light with Metal Guard Switch & Outlet
MA-70343	50 ft. 16/3 SJT Trouble Light with Metal Guard Switch & Outlet

BATTERIES



Part	Description
MA-210BD	Two "D" Alkaline Batteries Blister Pack, 48/Case
MA-211BC	Two "C" Alkaline Batteries Blister Pack, 48/Case
MA-213-AA	Two "AA" Alkaline Batteries Blister Pack 48/Case
MA-214-9V	9 Volt Alkaline Battery Blister Pack 48/Case
MA-215-AAA	Two "AAA" Alkaline Batteries Blister Pack 24/Case

MAGLIGHT REPLACEMENT BULBS

2 Bulbs per Package

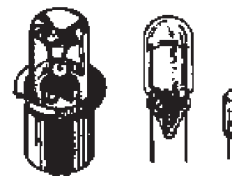

Part	Description
MA-LK3A001	Solitaire Replacement Lamp
MA-LM2A001	Mini Maglight AA Replacement Lamp
MA-LM3A001	Mini Maglight AAA Replacement Lamp
MA-LWSA201	2 Cell C or D Replacement Lamp
MA-LWSA301	3 Cell C or D Replacement Lamp
MA-LWSA401	4 Cell C or D Replacement Lamp
MA-LWSA501	5 Cell C or D Replacement Lamp

ALL-WEATHER EXTENSION CORDS



Part	Description
MA-73093	50 ft. 12/3 SJEOW Yellow
MA-74213	100 ft. 12/3 SJEOW Yellow

OUTDOOR EXTENSION CORDS

Part	Description
MA-60743	50 ft. 12/3 SJTW
MA-72023	100 ft. 12/3 SJTW
MA-70474	25 ft. 14/3 SJTW
MA-63493	50 ft. 14/3 SJTW
MA-61623	100 ft. 14/3 SJTW
MA-65093	25 ft. 16/3 SJTW
MA-63223	50 ft. 16/3 SJTW
MA-67363	100 ft. 16/3 SJTW

REPLACEMENT POWER SUPPLY CORDS



Part	Description
MA-09857	6 ft. 14/3 Black, Three Conductor SJE00W, 125V, 15 amp rating, UL listed
MA-09858	9 ft. 14/3 Black, Three Conductor, SJE00W, 125V, 15 amp rating, UL listed
MA-09709	9 ft 16/3 Black, Three Conductor SJTW, 125V, 13 amp rating, UL listed

LIGHT BULBS

GENERAL SERVICE BULBS

Part	Description
MA-4101	40 watt 4/package
MA-4102	60 watt 4/package
MA-4103	75 watt 4/package
MA-4104	100 watt 4/package
MA-4540	150 watt 1/package

ROUGH SERVICE BULBS

Part	Description
MA-4430	50 watt 6/package
MA-4429	60 watt 6/package
MA-4432	75 watt 6/package
MA-4431	100 watt 6/package
MA-4433	150 watt 6/package

TOUGHSKIN COATED SHATTER-PROOF BULBS

Part	Description
MA-4401	50 watt 6/package
MA-4402	60 watt 4/package
MA-4403	75 watt 4/package
MA-4404	100 watt 4/package



HANDI-TAP 3-OUTLET EXTENSION CORDS - ORANGE

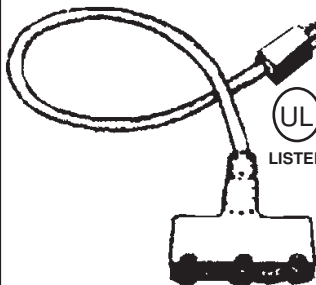

Part	Description
MA-72314	2 ft. 12/3 STW 15A
MA-71354	25 ft. 12/3, SJTW, 15A
MA-72744	50 ft. 12/3, SJTW, 15A
MA-62044	100 ft. 12/3, SJTW, 15A
MA-61834	25 ft. 14/3, SJTW, 15A
MA-60954	50 ft. 14/3, SJTW, 15A
MA-70204	100 ft. 14/3, SJTW, 15A

AIR CONDITIONING EXTENSION CORDS

MEETS OSHA SPECIFICATIONS!



Part	Description
MA-03532	6 ft. 14/3 Beige, SPT3, Right Angle Male Plug, 15A-125V, UL Listed
MA-03533	9 ft. 14/3 Beige, SPT3, Right Angle Male Plug, 15A-125V, UL Listed

TESTERS

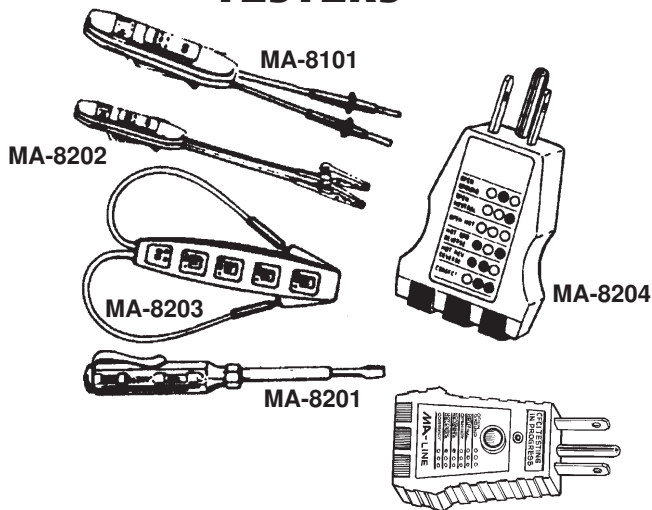

Part	Description
MA-8101	Circuit tester 90-300V AC/DC, neon glow indicates live circuit. Heavy duty twin lead tester.
MA-8202	Low voltage tester 5-50V AC/DC twin lead circuit tester w/alligator clips.
MA-8203	4 way tester for AC/DC voltages 110, 220, 277 and 440 with pocket clip.
MA-8201	Combination circuit tester/screwdriver for 80-250V AC/DC with pocket clip.
MA-8204	Pocket size electrical tester.
MA-8205	GFI Receptacle Tester



COMPRESSOR HOOK-UP KITS WITH 8" OR 18" LEADS

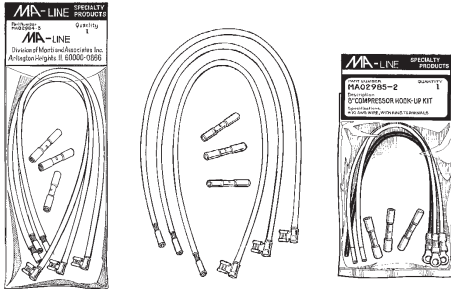

Part	Description
MA02984-2	8" Compressor Leads
MA02984-3	18" Compressor Leads
MA02985-2	8" Compressor Leads Ring
MA02985-3	18" Compressor Leads Ring

LINE VOLTAGE CORD ADAPTORS

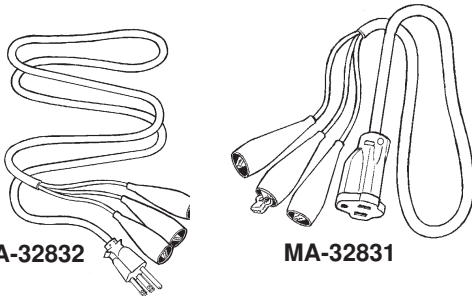

MA-32832

MA-32831

Part	Description
MA-32831	2' Female Cord Adaptor
MA-32832	6' Male Cord Adaptor

LOW VOLTAGE ASSORTED STYLES TEST LEADS

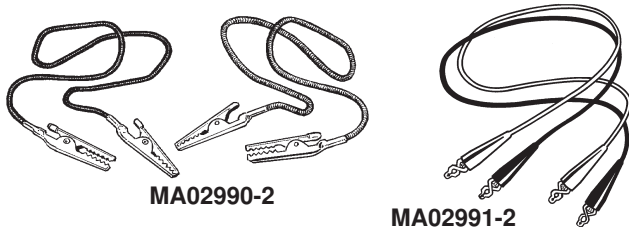

MA02990-2

MA02991-2
MA02991-3

Part	Description
MA02990-2	Test Lead Alligator Clip, 18 AWG, 24"
MA02991-2	Test Lead Alligator Clip, w/Boots, 18 AWG, 24"
MA02991-3	Heavy Duty Test Leads, w/Boots, 14 AWG, 24"

LOW VOLTAGE TEST LEADS



MA05031-2

MA05031-2	Low Voltage Test Leads Insulated Alligator Clips—10 wires: white, red, black, yellow, green, 18" Long Leads
-----------	---

TEST LEAD WITH START SWITCH

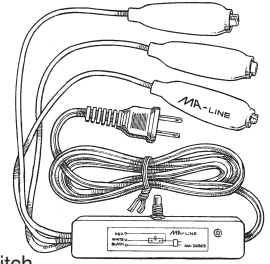

Part	Description
MA-69523	Test Lead Set with Start Switch

SOLENOID VOLTAGE TESTER

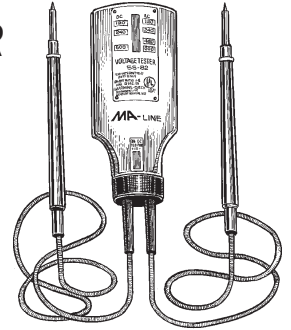

AC 120-240-480-600V; DC 120-240-600V
Polarity identification.
Designed with self-storing probes.
Retractable, locking, spring loaded shrouds
protect metal probe tips.
Strain relief assembly protects test leads.
UL listed

Part	Description
MA-8207	Solenoid Voltage Tester

RELAY/OVERLOAD COMBINATION

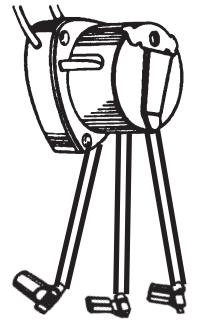

FEATURES:

- Built in Mounting Clip
- Mounts in any Position
- Prewired for Fast and Simple Installation
- Can Be Used with Either a Capacitor or Non-Capacitor Applications

SPECIFICATIONS:

- MA-IC13
1/4 & 1/3 HP 120V 50/60 HZ
- MA-IC15
1/8, 1/6, 1/5 HP 120V 50/60 HZ

Part	Description
MA-IC13	Relay / Overload
MA-IC15	Relay / Overload

ALLIGATOR AND BATTERY CLIPS

INSULATED AND NON-INSULATED

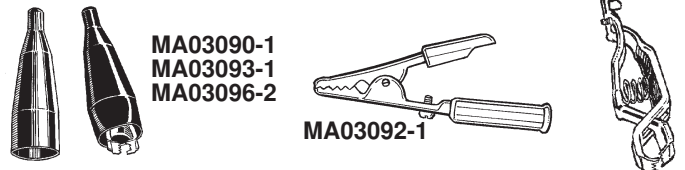

Part	Description	Part	Description
MA03090-1	Non-insulated—small	MA02933-1	Non-insulated—small
MA03093-1	Non-insulated—medium	MA02936-1	Non-insulated—medium
MA03096-2	18 AWG, 24" W/B & R Insulated Boots—Small		
MA03092-1	14 AWG, 24" Medium Size Cable Clamp Style Clip		
MA03093-1	W/B & R Insulated Boots—Large		
MA03096-2	Battery Clips wBoots-medium		

TEST LEAD ADAPTORS

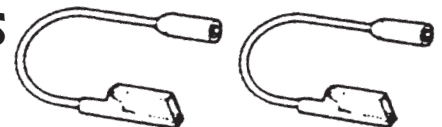

Part	Description	Pkg.
MA02987-2	Black/Red Adaptors 6" Length	2

VOLTAGE TESTER

TEST RANGE: 80-300V AC/DC, 50-60HZ

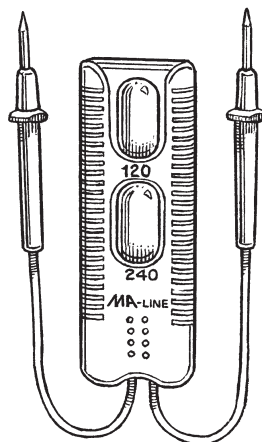

LARGE, HIGH VISIBILITY NEON INDICATOR POSITIVELY IDENTIFIES THE PRESENCE OF VOLTAGE.

Part	Description
MA-7321	Voltage Tester

LOW VOLTAGE DETECTOR AND LED FLASHLIGHT



FEATURES:

- Non-contact detection of AC Voltage from 24 to 1000V AC
- Rugged, double molded case
- Suitable for outlets or against wire insulation testing
- Flashing red LED light indicator
- Built-in, bright LED flashlight with ON/OFF button
- Convenient size with pocket clip
- For use on 50/60Hz circuits
- Red LED light and audible beeper indicator
- Includes 2 AAA batteries.

MA-49858A

SPECIFICATIONS:

Standard CAT III 1000V
 Operating Range 24 to 1000V AC
 Operating Temp. 14°F to 122°F (-10°C to 50°C)
 32°F to 86°F (0°C to 30°C); 95% Humidity 86°F to 104°F (30°C to 40°C); 75%
 104°F to 122°F (40°C to 50°C); 45%

Part	Description
MA-49858A	Low Voltage Detector and LED Flashlight

VOLTAGE TESTER

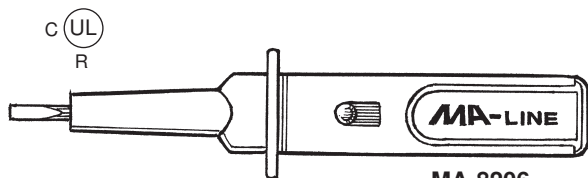

Part	Description
MA-8206	Volt Probe and Continuity Tester 4.25

BUSS BOX-COVER UNITS

Fuse Holder and Switch Units provide both protection for the motor and a switch for turning the device on and off.

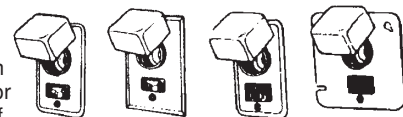

MA-SSU MA-SSW MA-SRU MA-SRY

Part	Description
MA-SSU	Cover for 2 1/4" Handy Box
MA-SSW	Cover for 2 3/4" Switch Box
MA-SSX	Cover for 4" Octagon Box
MA-SSY	Cover for 4" Square Box



FOR DEVICES USING ATTACHMENT CORD AND PLUG

Fuse Holder and Plug-In Receptacle Units offer protection in a most convenient form. The Plug-in Receptacle used is of the grounding type. It takes either ordinary 2-prong attachment plug cap, or the 2-prong parallel polarized cap with one wide prong, or 3-prong grounding type cap. For motors 3.4 hp or smaller—125 volts or less.

Part	Description	For devices permanently connected to circuit where switch control is desired.
MA-SRU	Cover for 2 1/4" Handy Box	
MA-SRY	Cover for 4" Square Box	

SPECIAL DEVICE IN-LINE SPLICES

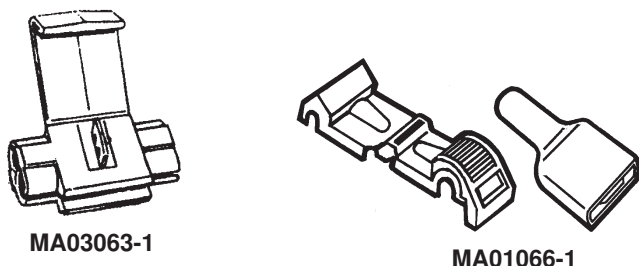

Part	Wire Range	Color	Pkg
MA03063-1	18-14 In-Line	Blue	8
MA01066-1	T-tap/Male Assortment Kit/Tab 250	Blue	8

IN-LINE FUSE HOLDER



FOR FUSING CONTROL CIRCUITS UP TO 30 AMPS

Part	Wire Range	Pkg
MA00014-1	18 gauge wire with 15 AMP fuse	2
MA00030-1	12 gauge wire with 30 AMP fuse	2

WIRE MARKER IDENTIFICATION SYSTEMS/ TAPE DISPENSERS/BOOKS

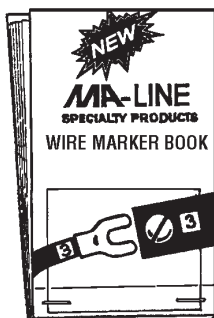

MA02152-2
 MA02153-2

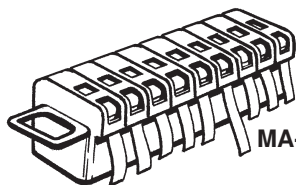

MA-2148-2

MA-LINE "MARK-IT"

FEATURES:

- Tough vinyl markers with acrylic adhesive
- Service temperature from -50°F to 200°F
- Sizes to suit wire ranges from 16 gauge to 1-1/2"
- Handy dispenser protects unused labels

Part	Description	Pkg
MA02148-2	Dispenser w/Tape 0-9	1
MA02149-2	Replacement rolls 0-4	1
MA02150-2	Replacement rolls 5-9	1
MA02151-2	Replacement rolls 0-9	1
MA02152-2	10-page Wire Marker Book #1 thru #45	
MA02153-2	10-page Wire Marker Book A-Z & 0-15, +, -, /	

"TWISTON" SPRING GRIP WIRE CONNECTORS

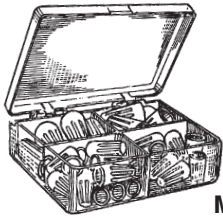

MA03751-2

BAGGED

Part	Color	Pkg	Part	Color	Pkg
MA01018-1	Grey	25	MA01020-2	Orange	50
MA01019-1	Blue	20	MA01021-2	Yellow	50
MA01020-1	Orange	15	MA01022-2	Red	50
MA01021-1	Yellow	10	MA01018-3	Grey	100
MA01022-1	Red	5	MA01019-3	Blue	100
MA01018-2	Grey	50	MA01020-3	Orange	100
MA01019-2	Blue	50	MA01021-3	Yellow	100
			MA01022-3	Red	100

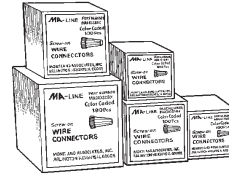

Part	Color	Pkg
MA06295-2	Five Color Assortment Pack	44
MA03751-2	Wire Connector Kit	50

BOXED

Part	Color	Pkg
MA01018BX	Grey	100
MA01019BX	Blue	100
MA01020BX	Orange	100
MA01021BX	Yellow	100
MA01022BX	Red	100

Color	Wire Range
Gray	No. 22 thru 14 AWG Min. 1 No. 20 & 1 No. 22 Max. 2 No. 16
Blue	No. 22 thru 14 AWG Min. 1 No. 18 & 1 No. 20 Max. 3 No. 16
Orange	No. 22 thru 14 AWG Min. 1 No. 18 & 1 No. 20 Max. 3 No. 16 & 1 No. 18
Yellow	No. 18 thru 10 AWG Min. 3 No. 18 Max. 3 No. 12
Red	No. 18 thru 8 AWG Min. 2 No. 14 Max. 2 No. 10 & 2 No. 12

240 PIECE ASSORTED WIRE CONNECTORS

IN A PLASTIC TUB

CONTENTS:

- 100 Blue
- 45 Yellow
- 65 Orange
- 30 Red

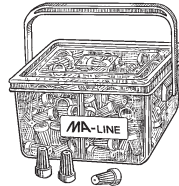

Part	Description
MA06295P	Assorted Wire Connectors

ASSORTED WINGED WIRE CONNECTORS

IN A PLASTIC TUB

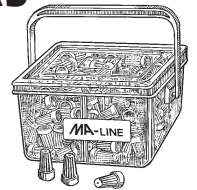

Part	Description	Pkg
MA10610P	Assorted Winged Wire Connectors	110
MA04233-2	10 Blue, 20 Grey, 50 Yellow, 30 Red 22-18 Tub (Tan)	120

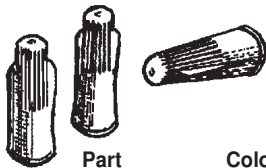

SOFT WIRE CONNECTORS

SPECIAL DEVICES SCOTCHLOCKS®

Part	Color	Pkg
MA03078-1	Yellow	15
MA03075-1	Red	10
MA03077-1	Grey	5
MA03080-1	Blue	3
MA03079-2	Yellow	75
MA03076-2	Red	75
MA03073-2	Grey	25
MA03373-2	Blue	25

PORCELAIN WIRE CONNECTORS

MAXIMUM TEMPERATURE RATING UP TO 1800°F (982°C)

- SMALL** - 2x18ga, 3x18ga or 4x20ga
- MEDIUM** - 3x18ga, 4x18ga or 5x20ga
- LARGE** - 2x14ga, 5x18ga or 6x20ga

Part	Description	Pkg
MA01164-1	Small Wire Nut	15
MA01164C-2	Small Wire Nut	100
MA01165-1	Medium Wire Nut	10
MA01165C-2	Medium Wire Nut	100
MA01166-1	Large Wire Nut	10
MA01166C-2	Large Wire Nut	100

WIRE CONNECTORS

IN A PLASTIC TUB

Part	Qty	Color
MA01018P	500	Grey
MA01019P	500	Blue
MA01020P	250	Orange
MA01021P	250	Yellow
MA01022P	100	Red

Wire Connector Chart

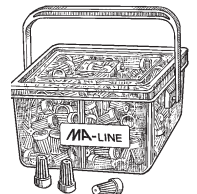

WINGED WIRE CONNECTORS BAGGED OR BOXED



Part	Wire Range	Color	Pkg
MA04132-1	22-18	Tan	25
Wire Range: Max: 3 #10, Min: 3#22 Voltage: 600v/300v			
MA10602-1		Yellow	15
MA10604-1		Red	10
MA10606-1		Grey	5
MA10608-1		Blue	5
MA10602-2		Yellow	100
MA10604-2		Red	100
MA10606-2		Grey	50
MA10608-2		Blue	50
MA10602BX		Yellow	100
MA10604BX		Red	100
MA10606BX		Grey	50
MA10608BX		Blue	50

CLOSED END CONNECTORS

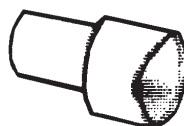

Part	Wire Range	Dimension	Pkg
MA02548-1	16-14	7/8"	10
MA02549-1	22-18	5/8"	15
MA02551-1	12-10	5/8"	10
MA03033-2	22-18	5/8"	100
MA03034-2	12-10	5/8"	100
MA03035-2	16-14	7/8"	100

PLASTIC ANCHOR KIT

- | | |
|-------------|--|
| Part | Description |
| MA-8410 | 3/16" x 3/4" Anchor Kit includes drill bit, 6-8 slotted pan head screws and 100 anchors |
| MA-8411 | 1/4" x 1" Anchor Kit includes drill bit, 10-12 slotted pan head screws and 100 anchors |
| MA-8412 | 5/16" x 1 1/2" Anchor Kit includes drill bit, 14-16 slotted pan head screws and 50 anchors |

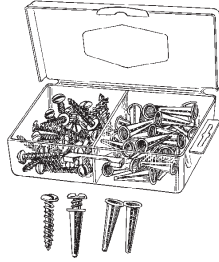

WIRE CONNECTOR ASSORTMENT

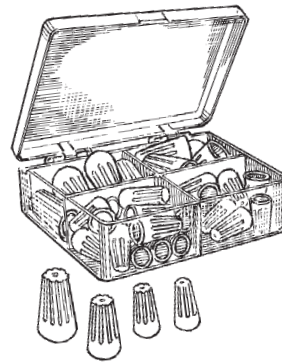

- | | |
|-------------|---|
| Part | Description |
| MA03751-2 | 50 Assorted pieces, blue, red, yellow, & orange connectors in a strong reusable plastic box |
| MA06295-2 | 44 Assorted pieces, grey blue, red, orange, & yellow in a reusable bag |

SPECIAL NUT KIT

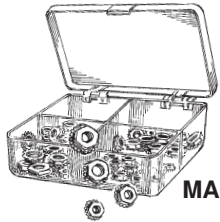

MA03754-2

NYLON INSERT LOCK NUT KIT



MA03756-2

- | | |
|-------------|--|
| Part | Description |
| MA03754-2 | 60 Assorted pieces Sizes 6-32, 8-32, 10-24, & 1/4-20 |
| MA03756-2 | 90 Assorted pieces sizes 6-32, 8-32, 10-24, 10-32, 1/4-20, & 5/16-18 |

SELF DRILLING ANCHORS KIT

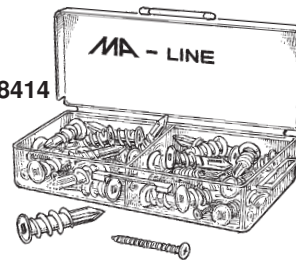

MA-8414

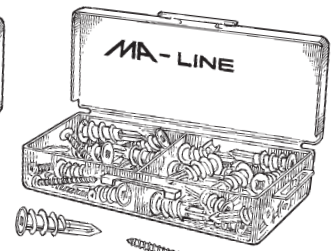

MA-8415

- | | |
|-------------|---|
| Part | Description |
| MA-8414 | Plastic self drilling anchor kit includes 50 anchors, 50 combination pan head screws 8 x 1-1/4" |
| MA-8415 | Metal self drilling anchor kit includes 50 anchors, 50 combination pan head screws 8 x 1-1/4" |

SOLDERLESS TERMINAL KIT NON-INSULATED LARGE GAUGE

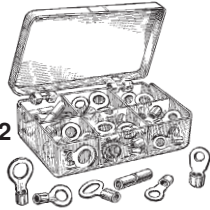

MA03802-2

SOLDERLESS TERMINAL KIT INSULATED



MA03752-2

- | | |
|-------------|-----------------------|
| Part | Description |
| MA03752-2 | 40-Piece Terminal Kit |
| MA03802-2 | 24-Piece Terminal Kit |

O'RING KIT

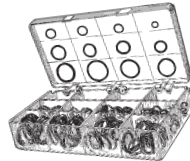

- | | | | |
|-------------------|---|-----|---------------------|
| Part | Description | | Kit Includes |
| MA-8413 | 12 Compartment kit, contains 200 assorted o'rings | | |
| 1/16" WALL | | | |
| MA-82006 | 1/4" ID x 3/8" OD o'ring | 100 | 40 |
| MA-82010 | 5/16" ID x 7/16" OD o'ring | 100 | 40 |
| 3/32" WALL | | | |
| MA-82011 | 3/8" ID x 9/16" OD o'ring | 100 | 30 |
| MA-82012 | 7/16" ID x 5/8" OD o'ring | 100 | 15 |
| MA-82110 | 1/2" ID x 11/16" OD o'ring | 100 | 10 |
| MA-82111 | 9/16" ID x 3/4" OD o'ring | 100 | 10 |
| MA-82112 | 5/8" ID x 13/16" OD o'ring | 100 | 10 |
| MA-82113 | 11/16" ID x 7/8" OD o'ring | 100 | 10 |
| MA-82114 | 3/4" ID x 15/16" OD o'ring | 100 | 10 |
| 1/8" WALL | | | |
| MA-82115 | 3/4" ID x 1" OD o'ring | 100 | 9 |
| MA-82118 | 13/16" ID x 1 1/16" OD o'ring | 100 | 8 |
| MA-82211 | 7/8" ID x 1 1/8" OD o'ring | 100 | 8 |

SHEET METAL SCREW KIT

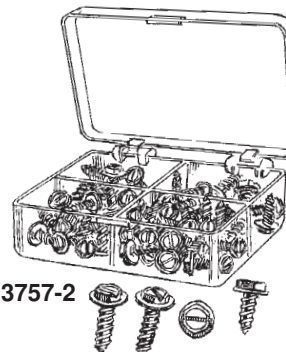

MA03750-2

SET SCREW KIT

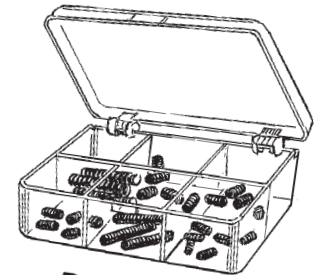

MA03750-2

- | | |
|-------------|--|
| Part | Description |
| MA03750-2 | 50 Assorted pieces Sizes 6-32x1/4, 8-32x1/4, 8-32x3/4, 10-24x1/4, 10-32x1/4, 10-32x3/4, 1/4-20x3/8, 5/16-18x3/8. |
| MA03757-2 | 60 Assorted pieces Sizes #8x1/2, #8x3/4, #10x1/2, #10x1 |

ASSORTED WIRE TIES IN A JAR

MA-WTJ1 - ASSORTED

- 4" Wire Ties 100 pcs. 50 Red 50 Black
- 5-1/2" Wire Ties 100 pcs. 50 White 50 Black
- 7-1/2" Wire Ties 200 pcs. 50 White 50 Black
50 Red 50 Blue
- 11" Wire Ties 150 pcs. 75 White 75 Black
- 14-1/2" Wire Ties 50 pcs. 50 White



MA-650N - NATURAL

- 4" Wire Ties 300 pcs.
- 7-1/2" Wire Ties 300 pcs.
- 11" Wire Ties 50 pcs.

MA-650B - BLACK

- 4" Wire Ties 300 pcs.
- 7-1/2" Wire Ties 300 pcs.
- 11" Wire Ties 50 pcs.

Part	Description
MA-WTJ1	Assorted Wire Ties in a Jar
MA-650N	Assorted Natural Wire Ties in a Jar
MA-650B	Assorted Black Wire Ties in a Jar

WIRE TIES NATURAL / WHITE

MA-Line supplies a complete line of wire ties with lengths from 4" to 48". Tough and reliable locking mechanism provides a strong, firm hold. For convenience, try the MA-Pak, and assortment of ties that will ensure having the right tie for the right job.

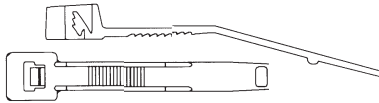

Standard Color—Natural 50 pound Tensile Strength

Part	Length	Bundle Dia.	Pkg.
MA02043-1	4" & 7-1/2"	Assortment	30
MA02044-1	11" & 14"	Assortment	30
MA02045-1	4" & 14"	Assortment	30
MA02046-1	4" & 5-1/2" & 7-1/2"	Assortment	27
MA03171-1	4"	1/16" to 3/4"	36
MA03172-2	4"	1/16" to 3/4"	100
MA03174-1	5-1/2"	1/16" to 1-1/2"	34
MA03175-2	5-1/2"	1/16" to 1-1/2"	100
MA03177-1	7-1/2"	1/16" to 1-3/4"	30
MA03178-2	7-1/2"	1/16" to 1-3/4"	100
MA03180-1	11"	1/16" to 3"	14
MA03181-2	11"	1/16" to 3"	50
MA03183-1	14"	1/16" to 4"	10
MA03184-2	14"	1/16" to 4"	50
MA03185-1	17"	1/16" to 4-1/2"	10
MA03188-2	17"	1/16" to 4-1/2"	50

BLACK NYLON WIRE TIES

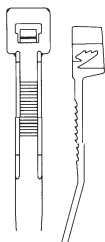

Part	Length	Bundle Dia.	Pkg.
MA04702-2B	4"	1/16" to 3/4"	100
MA04704-2B	5-1/2"	1/16" to 1-1/2"	100
MA04706-2B	7-1/2"	1/16" to 1-3/4"	100
MA04708-2B	11"	1/16" to 3"	50
MA04710-2B	14"	1/16" to 4"	50
MA04712-2B	17"	1/16" to 4-1/2"	50

WIRE TIE MOUNTING PAD NATURAL / WHITE

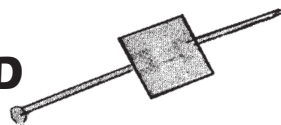

Part	Description	Pkg
MA03765-1	1" x 1" Flexible Base	10

DUCT TIES NATURAL WHITE & UV RATED BLACK EXTRA LONG 50 TIES PER PACKAGE

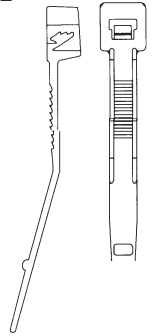

Part	Size
NATURAL	50 Ties per Package
MA021120-2	24" 175 lbs for 6" Duct
MA036175-2	36" 175 lbs for 11" Duct
MA048175-2	48" 175 lbs for 14" Duct
BLACK	50 Ties per Package
MA021120-2B	24" 175 lbs for 6" Duct
MA036175-2B	36" 175 lbs for 11" Duct
MA048175-2B	48" 175 lbs for 14" Duct

SCREWDOWN NYLON WIRE TIES NATURAL / WHITE

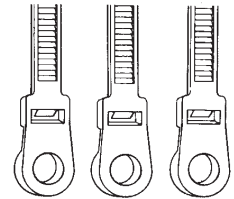

Part	Length	Bundle Dia.	Pkg.
MA03189-1	5-1/2"	1/16" to 1-1/2"	13
MA03190-2	5-1/2"	1/16" to 1-1/2"	100
MA03192-1	7-1/2"	1/16" to 1-3/4"	10
MA03193-2	7-1/2"	1/16" to 1-3/4"	100
MA03195-1	11"	1/16" to 3"	7
MA03196-2	11"	1/16" to 3"	50
MA03198-1	14"	1/16" to 4"	6
MA03199-2	14"	1/16" to 4"	50

PLENUM RATED WIRE TIES

SUITABLE FOR USE IN AIR
HANDLING SPACES.

Temperature Rating:
-65°F to 302°F (-54°C to 150°C)

Material: Tetzel® (Tetzel is a registered trademark of E.I. DuPont de Nemours & Co.)

- Weather Resistant
- Meets UL94V-0 Flammability Rating

Part	Color	Length	Bundle Dia.	Pkg.
MA07172-2	Aqua	4"	1/16" to 3/4"	100
MA07178-2	Aqua	7-1/2"	1/16" to 1-3/4"	100
MA07181-2	Aqua	11"	1/16" to 3"	50
MA07182-2	Aqua	14"	1/16" to 4"	50

ASSORTED MA-PACKS

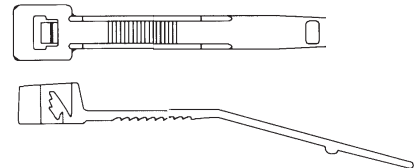

MA-PAK-1	250 Natural Ties	MA-PAK-2	300 Natural & Black Ties
100 each	4" Ties	50 each	4" Natural
100 each	7-1/2" Ties	50 each	7-1/2" Natural
50 each	11" Ties	50 each	7-1/2" Black
		50 each	11" Natural
		50 each	11" Black
		25 each	14" Natural
		25 each	14" Black

MA-PAK-3	450 Black Ties
200 each	5-1/2" Ties
200 each	7-1/2" Ties
50 each	11" Ties

GROMMETS VINYL ASSORTMENT

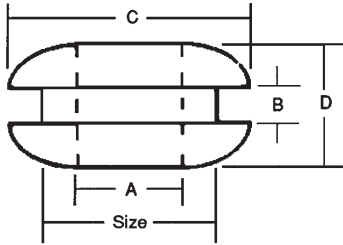

Size	A	B	C	D
1/4"	1/8"	1/16"	11/32"	3/16"
5/16"	3/16"	1/16"	7/16"	7/32"
3/8"	1/4"	1/16"	9/16"	1/4"
7/16"	5/16"	1/16"	5/8"	1/4"
1/2"	3/8"	1/16"	5/8"	1/4"
5/8"	1/2"	1/16"	13/16"	9/32"
21/32"	25/64"	1/8"	27/32"	3/8"
7/8"	5/8"	1/16"	1-1/8"	9/32"
1"	11/16"	1/16"	15/16"	3/8"

Part	Description	Pkg
MA00151-1	1/4", 5/16", 3/8" Assortment	40
MA00152-1	7/16", 1/2", 5/8" Assortment	20
MA00153-1	21/32", 7/8", 1" Assortment	10
MA00154-1	1/4" thru 1" Assortment	25
MA03161-1	1/4" Vinyl Grommets	40
MA03162-1	5/16" Vinyl Grommets	40
MA03163-1	3/8" Vinyl Grommets	35
MA03164-1	7/16" Vinyl Grommets	35
MA03165-1	1/2" Vinyl Grommets	30
MA03166-1	5/8" Vinyl Grommets	25
MA03167-1	21/32" Vinyl Grommets	15
MA03168-1	7/8" Vinyl Grommets	15
MA03169-1	1" Vinyl Grommets	5
MA03161-2	1/4" Vinyl Grommets	100
MA03162-2	5/16" Vinyl Grommets	100
MA03163-2	3/8" Vinyl Grommets	100
MA03164-2	7/16" Vinyl Grommets	100
MA03165-2	1/2" Vinyl Grommets	100
MA03166-2	5/8" Vinyl Grommets	100
MA03167-2	21/32" Vinyl Grommets	100
MA03168-2	7/8" Vinyl Grommets	100
MA03169-2	1" Vinyl Grommets	100

WIRE TIE INSTALLATION GUNS

For tensioning and for cutting. Durable, lightweight gun handles wire ties up to 50 lb. loop strength. Heavy Duty gun handles 120-175 lbs.

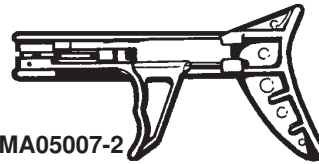

MA05007-2

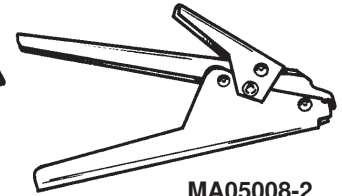

MA05008-2

Part	Description
MA05007-2	Lightweight Plastic Wire Tie Gun Small Wire Ties
MA05008-2	Heavy Duty Metal Wire Tie Gun Large Wire Ties

ELECTRICAL TAPE

ALL WEATHER
3/4" x 60 ft.

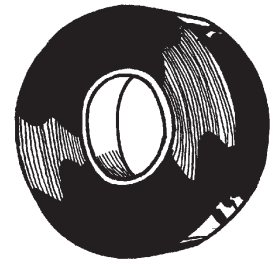

Part	Description
MA-C6408	Individual Roll
MA03364-2	Convenient 3-pack

NYLON CABLE CLAMPS AND ASSORTMENT PACKAGES

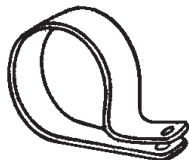

1/8" thru 9/16" - 3/8" Wide
5/8" thru 1" - 1/2" Wide



Part	Description	Pkg.
MA00036-1	Clamps, Grommet, Wire Ties	30
MA00098-1	1/8", 3/16", 1/4" Assortment	30
MA00099-1	5/16", 3/8", 7/16" Assortment	25
MA00100-1	1/2", 9/16", 5/8" Assortment	15
MA00101-1	3/4", 1" Assortment	10
MA00102-1	1/8" thru 1" Assortment	25
MA03149-1	1/8" Nylon Cable Clamps	35
MA03150-1	3/16" Nylon Cable Clamps	35
MA03151-1	1/4" Nylon Cable Clamps	25
MA03152-1	5/16" Nylon Cable Clamps	25
MA03153-1	3/8" Nylon Cable Clamps	25
MA03154-1	7/16" Nylon Cable Clamps	15
MA03155-1	1/2" Nylon Cable Clamps	15
MA03156-1	9/16" Nylon Cable Clamps	15
MA03157-1	5/8" Nylon Cable Clamps	15
MA03158-1	3/4" Nylon Cable Clamps	10
MA03159-1	1" Nylon Cable Clamps	10
MA03149-2	1/8" Nylon Cable Clamps	100
MA03150-2	3/16" Nylon Cable Clamps	100
MA03151-2	1/4" Nylon Cable Clamps	100
MA03152-2	5/16" Nylon Cable Clamps	100
MA03153-2	3/8" Nylon Cable Clamps	100
MA03154-2	7/16" Nylon Cable Clamps	100
MA03155-2	1/2" Nylon Cable Clamps	100
MA03156-2	9/16" Nylon Cable Clamps	100
MA03157-2	5/8" Nylon Cable Clamps	100
MA03158-2	3/4" Nylon Cable Clamps	100
MA03159-2	1" Nylon Cable Clamps	100

3M PREMIUM ELECTRICAL TAPE & VINYL COLOR CODING TAPE

Made in USA / UL & CSA listed
3/4" x 66' • UV Resistant
10 rolls per carton

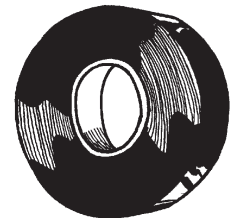

Part	Description
MA-C6433	3M Super 33+ Black/ 7 mil thickness
MA-C6488	3M Super 88 Black/ 8.5 mil thickness
MA-C6435G	3M 35 Gray Electrical Tape/ 7 mil thickness
MA-C6435B	3M 35 Blue Electrical Tape/ 7 mil thickness
MA-C6435O	3M 35 Orange Electrical Tape/ 7 mil thickness
MA-C6435R	3M 35 Red Electrical Tape/ 7 mil thickness
MA-C6435W	3M 35 White Electrical Tape/ 7 mil thickness
MA-C6435Y	3M 35 Yellow Electrical Tape/ 7 mil thickness
MA-C6435GN	3M 35 Green Electrical tape/ 7 mil thickness
MA-C6435BR	3M Brown Electrical Tape/ 7 mil thickness

3M SPLICING TAPE



All purpose rubber tape used for all voltage splicing, jacketing and general insulating.

Made in U.S.A.

Part	Description
MA-C2242	3/4" x 15' Roll

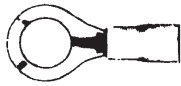

FLARED VINYL INSULATED RINGS

Part	Range	Stud	Pkg	Part	Range	Stud	Pkg
MA02536-1	16-14	6	20	MA02956-1	16-14	3/8	15
MA02537-1	16-14	8	20	MA02960-1	12-10	6	15
MA02528-1	16-14	10	20	MA02962-2	12-10	8	100
MA02532-1	16-14	1/4	15	MA02969-1	12-10	1/2	5
MA02581-1	12-10	8	15	MA02620-2	16-14	8	100
MA02530-1	12-10	10	15	MA02621-2	16-14	10	100
MA02534-1	12-10	1/4	10	MA02622-2	12-10	10	100
MA02577-1	22-18	6	20	MA02623-2	12-10	1/4	100
MA02578-1	22-18	8	20	MA02939-2	22-18	6	100
MA02579-1	22-18	10	20	MA02940-2	22-18	8	100
MA02580-1	22-18	1/4	15	MA02942-2	22-18	10	100
MA02944-2	22-18	1/4	100	MA02968-1	12-10	3/8	15
MA02951-2	16-14	6	100	MA02968-2	12-10	3/8	100
MA02952-2	16-14	1/4	100	MA02969-2	12-10	1/2	100
MA02955-2	16-14	5/16	100				

SOLDERLESS TERMINALS HIGH TEMPERATURE NON-INSULATED



MA02127-1



MA03798-1
MA03798-2



MA01128-1



MA02880-1



MA03362-1

MA02881-1

Part	Range	Stud	Pkg
MA01128-1	90 deg x fusite pin		20
	20-14		
MA02127-1	16-14	.250	4
MA02127-2	16-14	.250	100
RINGS			
MA02065-1	Ring 8	1/4	15
MA02065-2	Ring 8	1/4	100
MA02066-1	Ring 6	1/4	15
MA02066-2	Ring 6	1/4	100
MA02142-1	Ring 8	1/4	20
MA02142-2	Ring 8	1/4	100
MA03771-1	Ring 22-18	6	30
MA03772-1	Ring 22-18	10	30
MA03773-1	Ring 16-14	6	30
MA02860-1	Ring 16-14	10	30
MA02861-2	Ring 16-14	10	100
MA02869-1	Ring 12-10	10	20
MA02870-2	Ring 12-10	10	100
MA02872-1	Ring 12-10	1/4	15
MA02873-2	Ring 12-10	1/4	100
MA03774-1	Ring 16-14	1/4	20
MA03778-2	Ring 22-18	6	100
MA03779-2	Ring 22-18	10	100
MA03780-2	Ring 16-14	6	100
MA03781-2	Ring 16-14	1/4	100
DISCONNECTS			
MA02875-1	16-14F	250	20
MA02876-2	16-14F	250	100
MA02881-1	12-10F	250	20
MA02882-2	12-10F	250	100
MA03362-1	Flag 16-14	250	20
MA03363-2	Flag 16-14	250	100
MA03798-1	Flag 12-10	250	20
MA03798-2	Flag 12-10	250	100
MA03776-1	16-14F	187	20
MA03782-2	16-14F	187	100
MA03783-2	Female 22-18	3/16	100
MA03784-1	Male 22-18	3/16	20
MA03784-2	Male 22-18	3/16	100

BUTT SPLICE CONNECTORS FLARED - VINYL INSULATED

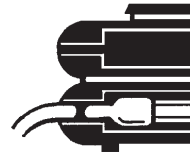

Part	Range	Pkg
MA02014-1	22-10	15
MA02521-1	16-14	20
MA02522-1	12-10	15
MA02591-1	22-18	20
MA02596-2	16-14	100
MA03011-2	22-18	100
MA03012-2	12-10	100

BUTT SPLICE CONNECTORS NON-INSULATED



Part	Range	Pkg
MA02816-1	22-18	20
MA02818-1	16-14	35
MA02820-1	12-10	35
MA03790-2	22-18	100
MA03791-2	16-14	100
MA03792-2	12-10	100

RINGS - SPADES - DISCONNECTS NON-INSULATED



MA02825-1



MA02823-1



MA02773-1

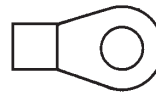

MA02726-1

Part	Range	Stud	Pkg
RINGS			
MA02707-2	22-18	6	100
MA02724-2	16-14	6	100
MA02726-1	16-14	8	35
MA02727-2	16-14	8	100
MA02729-1	16-14	10	35
MA02729-2	16-14	10	100
MA02744-1	12-10	8	25
MA02745-2	12-10	8	100
MA02746-1	12-10	10	25
MA02747-2	12-10	10	100
MA02749-1	12-10	1/4	20
MA01123-1	8	10	5
MA01124-1	8	1/4	5
SPADES			
MA02762-2	22-18	6	100
MA02770-1	16-14	6	35
MA02771-2	16-14	6	100
MA02773-1	16-14	8	35
MA02774-2	16-14	8	100
MA02776-1	16-14	10	35
MA02777-2	16-14	10	100
MA02779-1	12-10	6	25
MA02780-2	12-10	6	100
MA02782-1	12-10	8	25
MA02783-2	12-10	8	100
MA02785-1	12-10	10	25
MA02786-2	12-10	10	100
DISCONNECTS			
MA02821-1	22-18F	110	20
MA02822-2	22-18F	110	100
MA02823-1	22-18F	250	35
MA02824-2	22-18F	250	100
MA02825-1	16-14F	250	35
MA02826-2	16-14F	250	100
MA02827-1	12-10F	250	30
MA02828-2	12-10F	250	100
MA02830-1	22-18F	187	35
MA02833-1	16-14F	187	35
MA02834-2	16-14F	187	100
MA02837-2	22-18M	250	100
MA02839-1	16-14M	250	35
MA02840-2	16-14M	250	100
MA02842-1	12-10M	250	30
MA02843-2	12-10M	250	100

COMPRESSOR NON-INSULATED

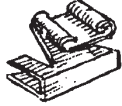

MA03343-1
MA01130-1



MA03360-1

Part	Wire Range	Tab Width	Pkg
MA03360-1	20-14	187	10
MA03343-1	12-8	250	5
MA03344-2	12-8	250	50
MA03344-3	12-8	250	100
MA03361-2	20-14	187	50
MA01130-1	16-14	250	10
MA01130-2	16-14	250	100

SPADES - FLARED VINYL INSULATED



MA01043-1



MA02585-1

Part	Wire Range	Stud	Pkg
MA02585-1	16-14	6 Stud	20
MA02544-1	16-14	8 Stud	20
MA02541-1	16-14	10 Stud	20
MA02547-1	12-10	8 Stud	15
MA02543-1	12-10	10 Stud	15
MA02583-1	22-18	6 Stud	20
MA02584-1	22-18	10 Stud	20
MA02597-2	16-14	8 Stud	100
MA02971-2	22-18	6 Stud	100
MA02973-1	22-18	8 Stud	20
MA02974-2	22-18	8 Stud	100
MA02975-2	22-18	10 Stud	100
MA02977-2	16-14	6 Stud	100
MA02978-2	16-14	10 Stud	100
MA02980-1	12-10	6 Stud	15
MA02982-2	12-10	8 Stud	100
MA02983-2	12-10	10 Stud	100
MA01042-1	22-18	8 Stud	20
MA01042-2	22-18	8 Stud	100
MA01043-1	16-14	8 Stud	20
MA01043-2	16-14	8 Stud	100
MA01046-1	12-10	10 Stud	15
MA01046-2	12-10	10 Stud	100

QUICK DISCONNECTS FLARED - VINYL INSULATED



MA02526-1

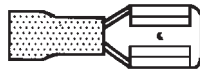

MA02598-2

Part	Range	Tab	Pkg
MA02013-1	Assrt		20
MA02526-1	16-14M	250	20
MA02586-1	22-18F	250	20
MA02587-1	22-18M	250	20
MA02588-1	16-14F	250	20
MA02589-1	12-10F	250	15
MA02590-1	12-10M	250	15
MA02598-2	16-14F	250	100
MA02619-2	12-10F	250	100
MA03013-2	22-18F	250	100
MA03015-1	22-18F	187	20
MA03016-2	22-18F	187	100
MA03018-1	16-14F	187	20
MA03019-2	16-14F	187	100
MA03022-2	16-14M	250	100
MA03023-2	12-10M	250	100
MA03028-1	16-14M	187	20
MA03029-2	16-14M	187	100

SPECIAL DEVICES DISCONNECTS

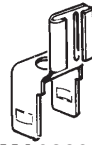

MA02896-1

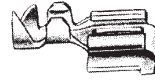

MA02906-1



MA02109-1



MA02903-1

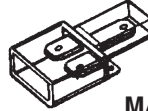

MA01023-1

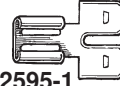

MA02595-1



MA03042-1



MA03349-1



MA01029-1

Part	Wire Range	Tab Width	Pkg
MA02109-1		250 insul (MA02911-2)	10
MA02595-1		250	15
MA02896-1		250	10
MA02896-2		250	100
MA02898-2		250 (MA02595-1)	100
MA02903-1		250	10
MA02904-2		250 (MA02903-1)	100
MA02906-1		250	10
MA02907-2		250 (MA02906-1)	100
MA02911-2		250 (MA02109-1)	100
MA03042-1		250	5
MA03349-1		250 tab 10 std.	10
MA01029-1	12-10	250	10
MA01029-2	12-10	250	100
MA01023-1		250	10
MA01023-2		250	100

QUICK DISCONNECT

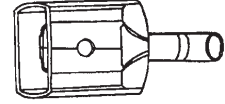
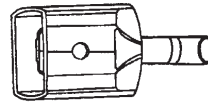

Part	Range	Tab	Pkg
MA03465-1	22-18MF	250	10
MA03466-1	16-14MF	250	10
MA03467-1	22-18F	250	10
MA03469-1	22-18M	250	10
MA03471-1	16-14F	250	10
MA03473-1	16-14M	250	10
MA03475-1	12-10F	250	10
MA03477-1	12-10M	250	10
MA03467-2	22-18F	250	100
MA03469-2	22-18M	250	100
MA03471-2	16-14F	250	100
MA03473-2	16-14M	250	100
MA03475-2	12-10F	250	100
MA03477-2	12-10M	250	100

FLAG DISCONNECT NON-INSULATED

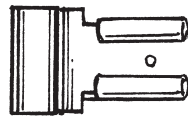

Part	Range	Tab	Pkg
MA02592-1	16-14F	250	30
MA03395-1	12-10F	250	15
MA02894-1	16-14F	187	20
MA02618-2	16-14F	250	100
MA02894-2	16-14F	187	100
MA03395-2	12-10F	250	100

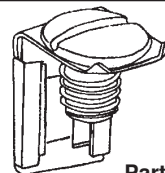

90 DEGREE DISCONNECT WITH SCREW

Part	Tab	Pkg
MA03775-1	.250	5
MA03775-2	.250	100

SMALL ASSORTMENT KITS INSULATED

ASSORTED RING & BUTT CONNECTORS

Part **MA02012-1** Pkg/Qty **14**

- 3 pcs. 12-10 Butt Connectors
- 3 pcs. 12-10 #10 Stud Spades
- 4 pcs. 12-10 #10 Stud Rings
- 2 pcs. 12-10 #8 Stud Rings
- 2 pcs. 12-10 1/4" Stud Rings

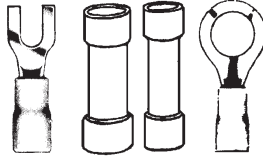

ASSORTED QUICK DISCONNECTS

Part **MA02013-1** Pkg/Qty **20**

- 2 pcs. 12-10F .250 Tab
- 2 pcs. 16-14F .250 Tab
- 2 pcs. 22-18F .250 Tab
- 2 pcs. 12-10M .250 Tab
- 2 pcs. 16-14M .250 Tab
- 2 pcs. 22-18M .250 Tab
- 2 pcs. 3 Way Adapter .250 Tab
- 2 pcs. Pin Type Male
- 2 pcs. .250 Special Device
- 2 pcs. .250 Special Device

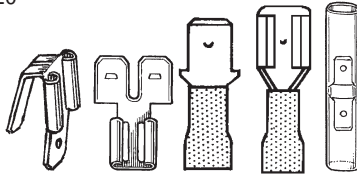

ASSORTED BUTT CONNECTORS

Part **MA02014-1** Pkg/Qty **17**

- 8 pcs. 16-14
- 6 pcs. 22-10
- 3 pcs. 12-10

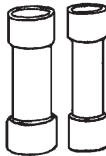

ASSORTED CONNECTORS

Part **MA02015-1** Pkg/Qty **20**

- 2 pcs. 22-18 Butt Connectors
- 2 pcs. 16-14 Butt Connectors
- 2 pcs. 12-10 Butt Connectors
- 2 pcs. 16-14 #10 Stud Spades
- 2 pcs. 12-10 #10 Stud Spades
- 2 pcs. 12-10 #10 Stud Rings
- 2 pcs. 16-14 #10 Stud Rings
- 2 pcs. 16-14 #6 Stud Rings
- 2 pcs. 22-18 #10 Stud Rings
- 2 pcs. 22-18 #6 Stud Rings

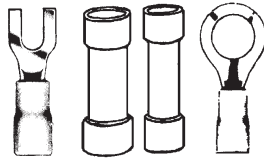

CONVENIENCE TERMINAL KITS

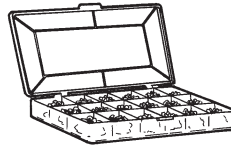

MA02652-2

Serviceman's Terminal Kit with Strong Plastic Box

Consists of 175 assorted insulated & non-insulated items that are often used To service air conditioning, refrigeration, & cooling units. Comes in a heavy duty, molded plastic case.

18 TOTAL ITEMS, 175 ASSORTED PIECES:

- 10 pcs. Insulated Q/D: Female, Blue: 16-14
- 7 pcs. Insulated Q/D: Female, Yellow: 12-10
- 7 pcs. Insulated Rings: Yellow: 12-10, 1/4" Stud
- 7 pcs. Insulated Rings: Yellow: 12-10, 8 Stud
- 10 pcs. Insulated Rings: Blue: 16-14, 10 Stud
- 10 pcs. Insulated Rings: Blue: 16-14, 8 Stud
- 10 pcs. Insulated Q/D: Male, Blue: 16-14
- 11 pcs. Butt Connectors: Red: 22-18
- 10 pcs. Butt Connectors: Blue: 16-14
- 7 pcs. Butt Connectors: Yellow: 12-10
- 10 pcs. Insulated Spades: Blue: 16-14, 10 Stud
- 10 pcs. Insulated Spades: Blue: 16-14, 8 Stud
- 16 pcs. Non-Insulated Flags: 16-14
- 16 pcs. Non-Insulated Piggy Backs: 16-14
- 8 pcs. Non-Insulated Compressor Terminals: 16-14
- 15 pcs. Closed-End Connectors: 16-14x8, 12-10x7
- 9 pcs. Wire Connectors: Orange x 4, Yellow x 5
- 3 pcs. Wire Connectors: Red



MA02653-2

Deluxe Serviceman's Terminal Kit with Sturdy Metal Box

Consists of 201 of the most popular assorted insulated and non-insulated items that are used to service air conditioning, refrigeration and cooling units. Also included is the MA-Line crimping tool Part #MA03200-2. Molded plastic tray keeps the items organized. Metal Case.

21 TOTAL ITEMS, 201 ASSORTED PIECES:

- 20 pcs. Insulated Disconnects: 16-14F / .250 TAB
- 15 pcs. Insulated Disconnects: 12-10F / .250 TAB
- 5 pcs. Compressor Non-Insulated: 12-18 / .250 TAB
- 10 pcs. Connectors and Adapters: .250 2 Male x 1 Female
- 10 pcs. Connectors and Adapters: .250 2 Male x 1 Female
- 10 pcs. Insulated Rings: 16-14, 10 Stud
- 10 pcs. Insulated Rings: 16-14, 8 Stud
- 10 pcs. Insulated Rings: 12-10, 1/4" Stud
- 10 pcs. Butt Connectors: Blue: 16-14
- 10 pcs. Butt Connectors: Yellow: 12-10
- 10 pcs. Butt Connectors: Red: 22-18
- 10 pcs. Closed End Connectors: 22-18
- 10 pcs. Closed End Connectors: 12-10
- 5 pcs. Non-Insulated Flag Disconnects: 16-14F
- 10 pcs. Insulated Spades: 16-14F, 8 Stud
- 10 pcs. Insulated Disconnects: 16-14M / .250 TAB
- 10 pcs. Insulated Rings: 12-10, 8 Stud
- 10 pcs. Insulated Spades: 16-14F, 10 Stud
- 10 pcs. Wire Connectors: Orange
- 5 pcs. Wire Connectors: Yellow
- 1 pc. Crimping Tool

Part	Description
MA02652-2	Terminal Kit
MA02653-2	Deluxe Terminal Kit

METAL STORAGE DRAWERS

21-Compartment Boxes

32-Compartment Boxes

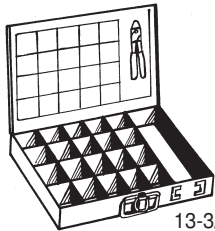

MA03375-2
13-3/16"L x 9-1/4" D x 2"H



MA03376-2
18"L x 12"D x 3"H

Part	Description
MA03375-2	21-Compartment Drawer
MA03376-2	32-Compartment Drawer

SLIDE RACKS FOR MA03375-2

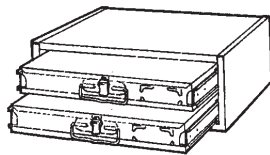

MA03353-2
2-Drawer Slide Rack
(does not include drawers)

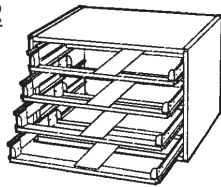

MA03355-2
4-Drawer Slide Rack
(does not include drawers)

Part	Description
MA03353-2	2-Drawer Slide Rack
MA03355-2	4-Drawer Slide Rack

PLASTIC STORAGE BOXES



MA-3612
12-Compartment Plastic Box
Dimensions: 6-1/2" deep x 10-3/4" long x 1-3/4" high



MA-3600
18-Compartment Plastic Box

Part	Description
MA-3600	18-Compartment plastic box
MA-3612	12-Compartment plastic box

STAINLESS STEEL MAGNETIC PARTS TRAY



Permanent magnet with rubber protection, fix on metal, horizontal, vertical, or upside down for preventing the loss of small parts. Convenient and practical, stainless steel powerful magnet.

Part	Description
MA-MGT1	Magnetic parts tray ROUND
MA-MGT2	Magnetic parts tray RECTANGULAR

MOTOR HOOK UP WIRE

UL 1015,
600V, 105C

STRANDED



Part	AWG	Ft/Spool
RED:		
MA03217-2	18	35
MA03218-2	16	20
MA03219-2	14	15
MA03220-2	12	12
MA03221-2	10	8
BLACK:		
MA03222-2	18	35
MA03223-2	16	20
MA03224-2	14	15
MA03225-2	12	12
MA03226-2	10	8
WHITE:		
MA03227-2	18	35
MA03228-2	16	20
MA03229-2	14	15
MA03230-2	12	12
MA03231-2	10	8
GREEN:		
MA03232-2	18	35
MA03233-2	16	20
MA03234-2	14	15
MA03235-2	12	12
MA03236-2	10	8
BLUE:		
MA03237-2	18	35
MA03238-2	16	20
MA03239-2	14	15
MA03240-2	12	12
MA03241-2	10	8

MOTOR HOOK UP WIRE 100' SPOOLS

Part	AWG	Ft/Spool
RED:		
MA03217-3	18	100
MA03218-3	16	100
MA03219-3	14	100
MA03220-3	12	100
MA03221-3	10	100
BLACK:		
MA03222-3	18	100
MA03223-3	16	100
MA03224-3	14	100
MA03225-3	12	100
MA03226-3	10	100
WHITE:		
MA03227-3	18	100
MA03228-3	16	100
MA03229-3	14	100
MA03230-3	12	100
MA03231-3	10	100
GREEN:		
MA03232-3	18	100
MA03233-3	16	100
MA03234-3	14	100
MA03235-3	12	100
MA03236-3	10	100
BLUE:		
MA03237-3	18	100
MA03238-3	16	100
MA03239-3	14	100
MA03240-3	12	100
MA03241-3	10	100

Due to the increased fluctuation in the copper market, prices may change without notice. These prices are not guaranteed. Please call for current pricing. This pertains to all copper wire on this page.

HIGH TEMPERATURE GLASS BRAIDED SILICONE/RANGE WIRE

SINGLE WIRE AND 3-STRAND TWISTED

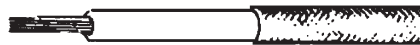

The wire listed can be used for leads to motors, transformers, appliances, electric or other electrical circuits where a flexible conductor is required to operate under high temperature conditions and where moisture may be present.

SPECIFICATIONS:

600 Max Volts, Max Temperature 400°F to 200°C. 14 Gauge UL 3071 and 12 gauge UL Style 3074, CSA Type SEW-2

SINGLE WIRE

Part	Length	Gauge	Color
MA0HT12R1	5'	12	Red
MA0HT12B1	5'	12	Black
MA0HT12W1	5'	12	White
MA0HT12R2	10'	12	Red
MA0HT12B2	10'	12	Black
MA0HT12W2	10'	12	White
MA0HT12R3	25'	12	Red
MA0HT12B3	25'	12	Black
MA0HT12W3	25'	12	White
MA0HT12R4	50'	12	Red
MA0HT12B4	50'	12	Black
MA0HT12W4	50'	12	White
MA0HT12R5	100'	12	Red
MA0HT12B5	100'	12	Black
MA0HT12W5	100'	12	White
MA0HT14R1	5'	14	Red
MA0HT14B1	5'	14	Black
MA0HT14W1	5'	14	White
MA0HT14R2	10'	14	Red
MA0HT14B2	10'	14	Black
MA0HT14W2	10'	14	White
MA0HT14R3	25'	14	Red
MA0HT14B3	25'	14	Black
MA0HT14W3	25'	14	White
MA0HT14R4	50'	14	Red
MA0HT14B4	50'	14	Black
MA0HT14W4	50'	14	White
MA0HT14R5	100'	14	Red
MA0HT14B5	100'	14	Black
MA0HT14W5	100'	14	White

3-STRAND TWISTED

COLORS: R = RED, B = BLACK, W = WHITE

Part	Length	Gauge	Color
MA0512G	5'	12	R,B,W
MA01012G	10'	12	R,B,W
MA02512G	25'	12	R,B,W
MA05012G	50'	12	R,B,W
MA0514G	5'	14	R,B,W
MA01014G	10'	14	R,B,W
MA02514G	25'	14	R,B,W
MA05014G	50'	14	R,B,W

3-STRAND CROSS-LINKED POLYETHYLENE RANGE WIRE

Can be used for appliances, coil leads, switchboard panels, transformers and motor leads.

SPECIFICATIONS:

600 Max Volts, Max temperature 250°F and 125°C. 12 & 14 gauge UL Type 3173, CSA Type CL1251/awm

SINGLE WIRE

Part	Length	Gauge	Color
MA0512P	5'	12	R,B,W
MA01012P	10'	12	R,B,W
MA02512P	25'	12	R,B,W
MA05012P	50'	12	R,B,W
MA0514P	5'	14	R,B,W
MA01014P	10'	14	R,B,W
MA02514P	25'	14	R,B,W
MA05014P	50'	14	R,B,W

COPPER STRANDED THHN WIRE

UL APPROVED



Due to the fluctuation in the copper metal market, prices are subject to change without notice.



500' SPOOLS

Part	Description
BLACK:	
MA-THHN8B	8 gauge
MA-THHN10B	10 gauge
MA-THHN12B	12 gauge
MA-THHN14B	14 gauge
RED:	
MA-THHN8R	8 gauge
MA-THHN10R	10 gauge
MA-THHN12R	12 gauge
MA-THHN14R	14 gauge
WHITE:	
MA-THHN8W	8 gauge
MA-THHN10W	10 gauge
MA-THHN12W	12 gauge
MA-THHN14W	14 gauge
GREEN:	
MA-THHN8G	8 gauge
MA-THHN10G	10 gauge
MA-THHN12G	12 gauge
MA-THHN14G	14 gauge

UL Approved Copper SOLID THHN WIRE

BLACK:	
MA-THHNS-10B	10 gauge
MA-THHNS-12B	12 gauge
MA-THHNS-14B	14 gauge
RED:	
MA-THHNS-10R	10 gauge
MA-THHNS-12R	12 gauge
MA-THHNS-14R	14 gauge
WHITE:	
MA-THHNS-10W	10 gauge
MA-THHNS-12W	12 gauge
MA-THHNS-14W	14 gauge
GREEN:	
MA-THHNS-10G	10 gauge
MA-THHNS-12G	12 gauge
MA-THHNS-14G	14 gauge

MA-LINE AIR CONDITIONING WHIPS

ASSEMBLED WITH
UL APPROVED COMPONENTS

KIT COMES COMPLETE
WITH 2 REDUCING WASHERS

METAL FITTINGS

Part	Description
MA-4012W	1/2" x 4' #10 THHN Wire 1-straight + 1-90 Connector
MA-4012WS	1/2" x 4' #10 THHN Wire 2-straight Connectors
MA-6012W	1/2" x 6' #10 THHN Wire 1-straight, +1-90 Connector
MA-6012WS	1/2" x 6' #10 THHN Wire 2-straight Connectors
MA-4034W	3/4" x 4' #8 THHN Wire 1-straight + 1-90 Connector
MA-4034WS	3/4" x 4' #8 THHN Wire 2-straight Connectors
MA-6034W	3/4" x 6' #8 THHN Wire 1-straight + 1-90 Connector
MA-6034WS	3/4" x 6' #8 THHN Wire, 2-straight Connectors

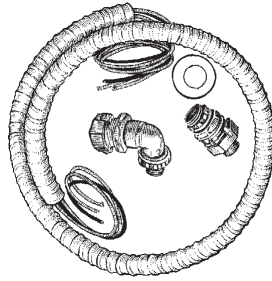

Due to the fluctuation in the copper metal market, prices are subject to change without notice.

PLASTIC FITTINGS (NON-METALLIC)

Part	Description
MA-P4012W	1/2" x 4' #10 THHN Wire 1-straight + 1-90 Connector
MA-P4012WS	1/2" x 4' #10 THHN Wire 2-straight Connector
MA-P6012W	1/2" x 6' #10 THHN Wire 1-straight + 1-90 Connector
MA-P6012WS	1/2" x 6' #10 THHN Wire 2-straight Connectors
MA-P4034W	3/4" x 4' #8 THHN Wire 1-straight + 1-90 Connector
MA-P4034WS	3/4" x 4' #8 THHN Wire 2-straight Connectors
MA-P6034W	3/4" x 6' #8 THHN Wire 1-straight + 1-90 Connector
MA-P6034WS	3/4" x 6' #8 THHN Wire 2-straight Connectors

AIR CONDITIONING DISCONNECTS - METAL

240 VAC, Single phase, Nema type 3R, Outdoor Enclosure.
UL & CSA LISTED

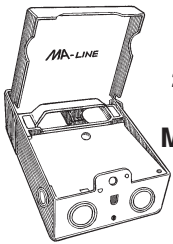

MA-FD30A
MA-FD60A

MA-NFD60A

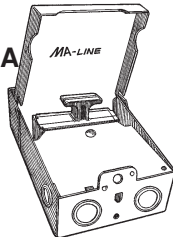

UL & CUL LISTED

Part	Description	Std. Ctn.
MA-NFD60A	60A, non-fused	6
MA-FD30A	30A, fused	6
MA-FD60A	60A, fused	6

TIME DELAYS

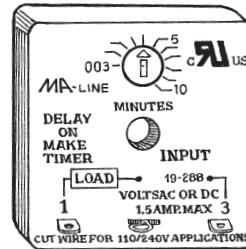

SPECIFICATIONS:

- Input:
- Line Voltage: 18-240 VAC/VDC
 - Line Frequency: 50/60 Hz
- Output:
- Maximum: 1.5 Amps
 - Minimum: 40 mA
 - Inrush: 15 Amps
- Time Delay:
- .03-10 Minutes, Adjustable

Part	Description
MA-30301	Time Delay - Delay on Make
MA-30303	Time Delay - Delay on Break

3 PHASE DISCONNECTS UL & CSA LISTED

240 VAC, Three phase, Nema type 3R,
Outdoor Enclosure.

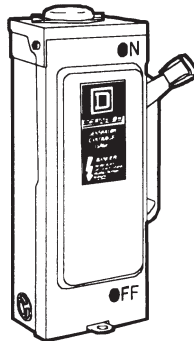

Part	Description	Std. Ctn.
MA-60NF3	60A, non-fused	1
MA-30F3	30A, fused	1
MA-60F3	60A, fused	1

AIR CONDITIONING DISCONNECTS WITH SIDE OPENING DOOR PLASTIC

240 VAC, Single phase, Nema type 3R, Outdoor Enclosure, Side Hinged.

UL & CSA LISTED

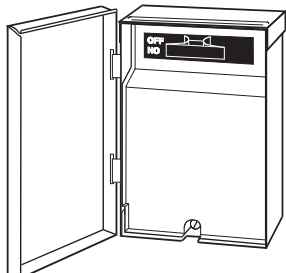

Part	Description	Std. Ctn.
UFP222RNM	60A, non-fused	10
FP221RNM	30A, fused	10
FP222RNM	60A, fused	10

"EXTRA-BOOST" HARD STARTS

ALL HARD START KITS ARE UL RECOGNIZED

These new units can increase starting torque from 300% to over 600% depending on the model used. They can be used on room AC, all residential and commercial PSC A/C units and heat pumps. They can be used on units rated from 4,000 to 120,000 BTUs and they can be used on 120 through 288 VAC units. All models are UL recognized and are for low voltage and hard starting compressors. All units contain a start capacitor and relay for extra starting torque. Installs in seconds across run capacitor terminals.

Voltage: 120-230 -
Residential/Commercial
UL Recognized



Part	Start Torque
MA-XP5	270 ounce
MA-XP6	390 ounce
MA-XP8	520 ounce

MA-LINE CLASS 2 TRANSFORMERS

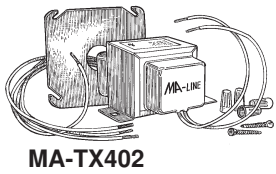

MA-TX402

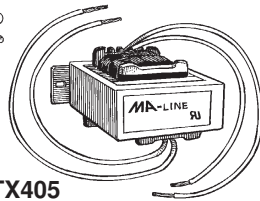

MA-TX405

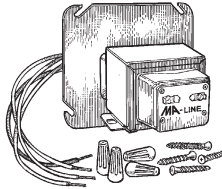

MA-TX501

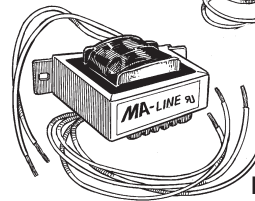

MA-TX502

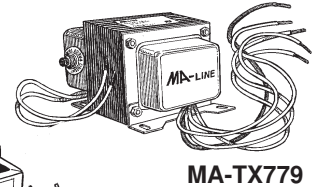

MA-TX779

Part	Replaces Part No.	Connection Type	Primary Voltage	Secondary Voltage	Output Rating	Mounting Style
MA-TX202	620-202	not U.L.	120	24	20 VA	Plug-In
MA-TX205	50351	wire lead	120	24	20 VA	Foot
MA-TX402	50333	wire lead	120/208/240	2, .5, 12, 24	48 VA	Multi
MA-TX403	50302	wire lead	120	24	40 VA	Multi
MA-TX404	50303	wire lead	208/240	24	40 VA	Multi
MA-TX405	50352	wire lead	120	24	40 VA	Foot
MA-TX406	50353	wire lead	208/240	24	40 VA	Foot
MA-TX407	50304	wire lead	120/208/240	24	40 VA	Multi
MA-TX482	50354	wire lead	120/208/240	24	40 VA	Foot
MA-TX501	620-501	terminal	120/208/240	28	50 VA	Universal Connection with Terminal Board
MA-TX502	50314	wire lead	120/208/240	24	50 VA	Multi
MA-TX775	50320	wire lead	120/208/240/480 with fuse	24	75 VA	Foot
MA-TX779	50321	wire lead	120/208/240/480 with circuit breaker	24	75 VA	Foot
MA-TX100	N/A	wire lead	120/208/240/480 with circuit breaker	24	100 VA	Foot

WORLD SOURCE DEFINITE PURPOSE CONTACTORS

Part	Full Load Amperes	Coil VAC	Std Pk
1-POLE CONTACTORS			
1P30A24V	30	24	1
1P40A24V	40	24	1

Part	Full Load Amperes	Coil VAC	Std Pk
1.5-POLE CONTACTORS			
112P30A24V	30	24	1
112P30A120V	30	120	1
112P30A240V	30	240	1

Part	Full Load Amperes	Coil VAC	Std Pk
2-POLE CONTACTORS			
2P20A24V	20	24	1
2P30A24V	30	24	1
2P30A120V	30	120	1
2P30A240V	30	240	1
2P40A24V	40	24	1
2P40A120V	40	120	1
2P40A240V	40	240	1

Part	Full Load Amperes	Coil VAC	Std Pk
3-POLE CONTACTORS			
3P30A24V	30	24	1
3P30A120V	30	120	1
3P30A240V	30	240	1
3P40A24V	40	24	1
3P40A120V	40	120	1
3P40A240V	40	240	1
3P50A24V	50	24	1
3P50A120V	50	120	1
3P50A240V	50	240	1
3P60A24V	60	24	1
3P60A120V	60	120	1
3P60A240V	60	240	1

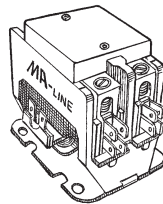

- FEATURES:**
- Universal Mount
 - Individually Packaged
 - UR cUL Listed
 - Lug Terminal with Quick Connects

DEFINITE PURPOSE CONTACTORS



SQUARE D
Schneider Electric

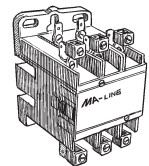

Definite Purpose Contactors are ideal for the Heating, Air Conditioning, Refrigeration, Data Processing and Food Service Equipment.

- FEATURES:**
- UL Component Recognized
 - UL Listed
 - CSA Certified
 - DPA is CE Marked

SPECIFICATIONS:
Up to 30 Ampere;
Quick connect terminals and binder head screws for easy wiring.
40 Ampere and Larger.
Box lugs are standard.

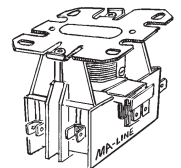

3-POLE CONTACTORS Large Frame Series

Part	Full Load Amperes	Coil VAC	Std Pk
8910DPA23V14	25	24	1
8910DPA23V02	25	120	1
8910DPA23V09	25	240	1
8910DPA33V14	30	24	1
8910DPA33V02	30	120	1
8910DPA33V09	30	240	1
8910DPA43V14	40	24	1
8910DPA43V02	40	120	1
8910DPA43V09	40	240	1
8910DPA53V14	50	24	1
8910DPA53V02	50	120	1
8910DPA53V09	50	240	1
8910DPA63V14	60	24	1
8910DPA63V02	60	120	1
8910DPA63V09	60	240	1
8910DPA73V14	75	24	1
8910DPA73V02	75	120	1
8910DPA73V09	75	240	1
8910DPA93V14	90	24	1
8910DPA93V02	90	120	1
8910DPA93V09	90	240	1

2-POLE CONTACTORS Compact (Small Frame) Series

Part	Full Load Amperes	Coil VAC	Std Pk
8910DP22V14	25	24	1
8910DP22V02	25	120	1
8910DP22V09	25	240	1
8910DP32V14	30	24	1
8910DP32V02	30	120	1
8910DP32V09	30	240	1
8910DP42V14	40	24	1
8910DP42V02	40	120	1
8910DP42V09	40	240	1



SQUARE D-STYLE CIRCUIT BREAKERS

UL & CSA LISTED

QO STYLE BREAKERS

with VISI-TRIP® (Visual Red Indicator in Window)

BY SQUARE D

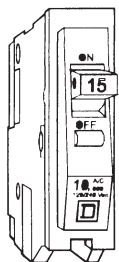

SINGLE POLE, 120/240 VAC

Part	Description
QO115	15 amp
QO120	20 amp
QO130	30 amp
QO140	40 amp
QO150	50 amp
QO160	60 amp

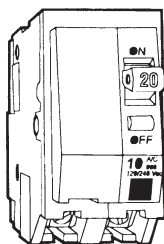

DOUBLE POLE, 120/240 VAC

Part	Description
QO215	15 amp
QO220	20 amp
QO230	30 amp
QO240	40 amp
QO250	50 amp
QO260	60 amp

HOMELINE® CIRCUIT BREAKERS

BY SQUARE D

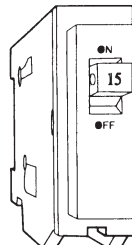

SINGLE POLE, 120/240 VAC

Part	Description
HOM115	15 amp
HOM120	20 amp
HOM130	30 amp
HOM140	40 amp
HOM150	50 amp

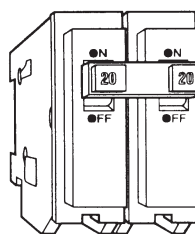

DOUBLE POLE, 120/240 VAC

Part	Description
HOM215	15 amp
HOM220	20 amp
HOM230	30 amp
HOM240	40 amp
HOM250	50 amp
HOM260	60 amp

SIEMENS CIRCUIT BREAKERS

Compatibility list for SIEMENS REPLACEMENT BREAKERS: American Switch, Westinghouse (Bryant), Challenger (Sylvania), Crouse-Hinds (Murray), Frank Adams, General Electric (full size only), General Switch, I-T-E Gould, Montgomery Wards, Sears.

UL & CSA Approved

SINGLE POLE

120/240 VAC, COMMON TRIP

Part	Description
MA-Q115	15 Amp
MA-Q120	20 Amp
MA-Q125	25 Amp
MA-Q130	30 Amp
MA-Q140	40 Amp
MA-Q150	50 Amp
MA-Q160	60 Amp

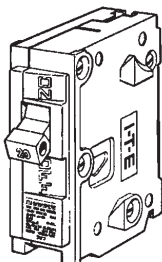

DOUBLE POLE

240 VAC, COMMON TRIP

MA-Q215	15 Amp
MA-Q220	20 Amp
MA-Q225	25 Amp
MA-Q230	30 Amp
MA-Q240	40 Amp
MA-Q250	50 Amp
MA-Q260	60 Amp
MA-Q270	70 Amp
MA-Q280	80 Amp
MA-Q290	90 Amp
MA-Q2100	100 Amp
MA-Q2125	125 Amp

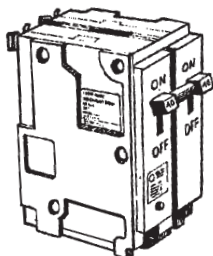

SIEMENS DUAL CIRCUIT BREAKERS

SINGLE-POLE, 120/240 VAC

Part	Description
MA-QT1515	15-15 Amp Dual
MA-QT1520	15-20 Amp Dual
MA-QT2020	20-20 Amp Dual
MA-QT2030	20-30 Amp Dual
MA-QT3030	30-30 Amp Dual

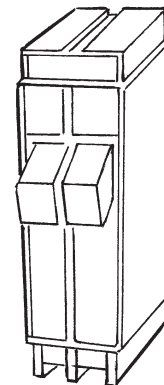

SIEMENS REPLACEMENT CIRCUIT BREAKERS FOR SQUARE D-STYLE BREAKERS

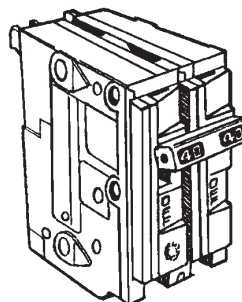

UL & CSA Approved

SINGLE POLE 120/240 VAC

Part	Description
MA-D115	15 Amp
MA-D120	20 Amp
MA-D130	30 Amp
MA-D140	40 Amp
MA-D150	50 Amp
MA-D160	60 Amp

DOUBLE POLE 120/240 VAC

MA-D215	15 Amp
MA-D220	20 Amp
MA-D230	30 Amp
MA-D240	40 Amp
MA-D250	50 Amp
MA-D260	60 Amp

FUSETRON® BUSS FUSES

**DUAL ELEMENT
TIME DELAY
250 VOLT, CLASS RK5 FUSES**

Part	AMP	Pkg
MA-FRNR1	1	10
MA-FRNR1.25	1.25	10
MA-FRNR1.6	1.6	10
MA-FRNR2	2	10
MA-FRNR2.5	2.5	10
MA-FRNR3.2	3.2	10
MA-FRNR4	4	10
MA-FRNR5	5	10
MA-FRNR6.25	6.25	10
MA-FRNR8	8	10
MA-FRNR10	10	10
MA-FRNR12	12	10
MA-FRNR15	15	10
MA-FRNR20	20	10
MA-FRNR25	25	10
MA-FRNR30	30	10
MA-FRNR35	35	10
MA-FRNR40	40	10
MA-FRNR45	45	10
MA-FRNR50	50	10
MA-FRNR60	60	10
MA-FRNR70	70	5
MA-FRNR80	80	5
MA-FRNR90	90	5
MA-FRNR100	100	5
MA-FRNR110	110	1
MA-FRNR125	125	1
MA-FRNR150	150	1
MA-FRNR175	175	1
MA-FRNR200	200	1
MA-FRNR225	225	1

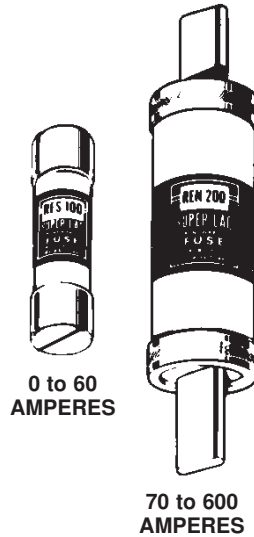

**DUAL ELEMENT
TIME DELAY
600 VOLT, CLASS RK5 FUSES**

Part	AMP	Pkg
MA-FRSR1	1	10
MA-FRSR1.25	1.25	10
MA-FRSR1.6	1.6	10
MA-FRSR2	2	10
MA-FRSR2.5	2.5	10
MA-FRSR3.2	3.2	10
MA-FRSR4	4	10
MA-FRSR5	5	10
MA-FRSR6.25	6.25	10
MA-FRSR8	8	10
MA-FRSR10	10	10
MA-FRSR12	12	10
MA-FRSR15	15	10
MA-FRSR20	20	10
MA-FRSR25	25	10
MA-FRSR30	30	10
MA-FRSR35	35	10
MA-FRSR40	40	10
MA-FRSR45	45	10
MA-FRSR50	50	10
MA-FRSR60	60	10
MA-FRSR70	70	5
MA-FRSR80	80	5
MA-FRSR90	90	5
MA-FRSR100	100	5
MA-FRSR110	110	1
MA-FRSR125	125	1
MA-FRSR150	150	1
MA-FRSR175	175	1
MA-FRSR200	200	1
MA-FRSR225	225	1

**BUSS HEATING AND
AIR CONDITIONING FUSES
250 VOLT**

Designed for heating and air conditioning applications.

UL Listed
CSA Certified
Class RK5 Fuse

A general purpose time-delay cartridge fuse for residential and light-duty motor protection.

**TIME DELAY, 250 VOLT, CURRENT LIMITING
CLASS RK5, UL LISTED, CSA HRC1-R**

Part	AMP	Pkg
MA-HACR3.2	3.2	10
MA-HACR5	5	10
MA-HACR6.25	6.25	10
MA-HACR10	10	10
MA-HACR15	15	10
MA-HACR20	20	10
MA-HACR25	25	10
MA-HACR30	30	10
MA-HACR35	35	10
MA-HACR40	40	10
MA-HACR45	45	10
MA-HACR50	50	10
MA-HACR60	60	10
MA-HACR70	70	5
MA-HACR80	80	5
MA-HACR100	100	5
MA-HACR125	125	1
MA-HACR200	200	1

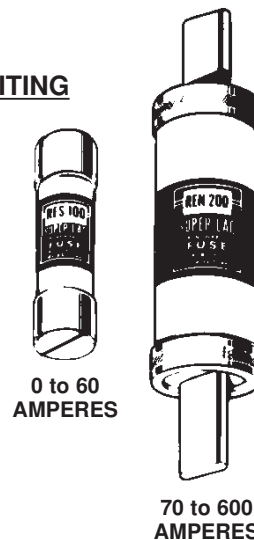

MA-HASR Series Fuses Have Been Replaced by the MA-DLSR Series. It has the same form, fit and function as the HASR Product Line.

**Time Delay, 600V, Current Limiting
Class RK5, UL Listed, CSA HRC1-R**

Part	AMP	Pkg
MA-DLSR10	10	10
MA-DLSR15	15	10
MA-DLSR20	20	10
MA-DLSR25	25	10
MA-DLSR30	30	10
MA-DLSR35	35	10
MA-DLSR40	40	10
MA-DLSR45	45	10
MA-DLSR50	50	10
MA-DLSR60	60	10
MA-DLSR70	70	5
MA-DLSR80	80	5
MA-DLSR90	90	5
MA-DLSR100	100	5
MA-DLSR125	125	5
MA-DLSR150	150	1
MA-DLSR200	200	1

ONE TIME FUSE-250 VOLT

BUSS FUSES



Part	AMP	Pkg
MA-NON1	1	10
MA-NON3	3	10
MA-NON6	6	10
MA-NON10	10	10
MA-NON15	15	10
MA-NON20	20	10
MA-NON25	25	10
MA-NON30	30	10
MA-NON35	35	10
MA-NON40	40	10
MA-NON45	45	10
MA-NON50	50	10
MA-NON60	60	10
MA-NON70	70	5
MA-NON80	80	5
MA-NON100	100	5
MA-NON150	150	1
MA-NON175	175	1
MA-NON200	200	1

S PLUG FUSES DUAL ELEMENT TIME DELAY 250 VOLT

BUSS FUSES



Part	AMP	Pkg	Part	AMP	Pkg
MA-S1A	1	4	MA-S6A	6	4
MA-S11/4A	1.25	4	MA-S61/4A	6.25	4
MA-S16A	1.6	4	MA-S8A	8	4
MA-S2A	2	4	MA-S10A	10	4
MA-S21/2A	2.5	4	MA-S12A	12	4
MA-S32A	3.2	4	MA-S15A	15	4
MA-S4A	4	4	MA-S20A	20	4
MA-S5A	5	4	MA-S25A	25	4
			MA-S31A	30	4

SL & TL PLUG FUSE TIME DELAY 250 VOLT

BUSS FUSES



T PLUG FUSES DUAL ELEMENT TIME DELAY 250 VOLT

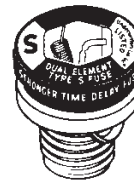

Part	AMP	Pkg
MA-SL15A	15	4
MA-SL20A	20	4
MA-SL25A	25	4
MA-SL30A	30	4
MA-TL15A	15	4
MA-TL20A	20	4
MA-TL25A	25	4
MA-TL30A	30	4

BUSS FUSES

Part	AMP	Pkg
MA-T1A	1	4
MA-T11/4A	1.25	4
MA-T16A	1.6	4
MA-T2A	2	4
MA-T21/2A	2.5	4
MA-T32A	3.2	4
MA-T4A	4	4
MA-T5A	5	4
MA-T61/4A	6.25	4
MA-T7A	7	4
MA-T8A	8	4
MA-T10A	10	4
MA-T12A	12	4
MA-T15A	15	4
MA-T20A	20	4
MA-T25A	25	4
MA-T30A	30	4

W PLUG FUSE 250 VOLT

BUSS FUSES



Part	AMP	Pkg
MA-W3A	3	4
MA-W5A	5	4
MA-W6A	6	4
MA-W8A	8	4
MA-W10A	10	4

NOTE:

Plug Fuses MA-W15A to MA-W30A

Replaced by MA-T15A to MA-T30A or MA-TL15A to MA-TL30A amp.

TYPE S FUSE ADAPTOR



Part	AMP	Pkg
MA-16SA	1.6 Adaptor	4
MA-21/2SA	2.5 Adaptor	4
MA-32SA	3.2 Adaptor	4
MA-61/4SA	6.25 Adaptor	4
MA-15SA	15 Adaptor	4
MA-20SA	20 Adaptor	4
MA-30SA	30 Adaptor	4

BUSS BOX-COVER UNITS

Fuse Holder and Switch

Units provide both protection for the motor and a switch for turning the device on and off.

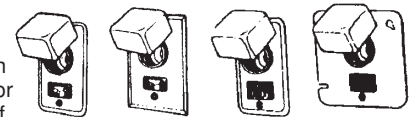

MA-SSU MA-SSW MA-SRU MA-SRY

Part Description

- MA-SSU Cover for 2 1/4" Handy Box
- MA-SSW Cover for 2 3/4" Switch Box
- MA-SSX Cover for 4" Octagon Box
- MA-SSY Cover for 4" Square Box



MA-SSX



MA-SSY

FOR DEVICES USING ATTACHMENT CORD AND PLUG

Fuse Holder and Plug-In Receptacle Units offer protection in a most convenient form. The Plug-in Receptacle used is of the grounding type. It takes either ordinary 2-prong attachment plug cap, or the 2-prong parallel polarized cap with one wide prong, or 3-prong grounding type cap. For motors 3.4 hp or smaller—125 volts or less.

Part Description

- MA-SRU Cover for 2 1/4" Handy Box
- MA-SRY Cover for 4" Square Box

For devices permanently connected to circuit where switch control is desired.

1/4 X 1 1/4" GLASS AND CERAMIC FUSES

UL LISTED, CSA CERTIFICATION

These fast acting Buss fuses are used to protect electronic devices. A fast acting fuse most generally has a single strand of wire or a straight strip of metal. Fuses are available in a wide variety of amperage to provide precise protection. All fuses have a maximum voltage rating. To maintain safety this voltage should not be exceeded, although it is acceptable to use the fuse at lower voltage applications.

Part	5 fuses per tin Ceramic Fuses	Maximum Voltage
MA-ABC-1	1 Amp	250
MA-ABC-2	2 Amp	250
MA-ABC-3	3 Amp	250
MA-ABC-5	5 Amp	250
MA-ABC-6	6 Amp	250
MA-ABC-8	8 Amp	250
MA-ABC-10	10 Amp	250
MA-ABC-12	12 Amp	250
MA-ABC-15	15 Amp	250
MA-ABC-20	20 Amp	250
MA-ABC-30	30 Amp	250

250 VOLT



Part	5 fuses per tin Glass Fuses	Maximum Voltage
MA-AGC-1/32	1/32 Amp	250
MA-AGC-1/4	1/4 Amp	250
MA-AGC-1/2	1/2 Amp	250
MA-AGC-3/4	3/4 Amp	250
MA-AGC-1	1 Amp	250
MA-AGC-1-1/4	1-1/4 Amp	250
MA-AGC-1-1/2	1-1/2 Amp	250
MA-AGC-2	2 Amp	250
MA-AGC-2-1/2	2-1/2 Amp	250
MA-AGC-3	3 Amp	250
MA-AGC-4	4 Amp	250
MA-AGC-5	5 Amp	250
MA-AGC-6	6 Amp	250
MA-AGC-7	7 Amp	250
MA-AGC-8	8 Amp	250
MA-AGC-9	9 Amp	250
MA-AGC-10	10 Amp	250
MA-AGC-15	15 Amp	250
MA-AGC-20	20 Amp	250
MA-AGC-25	25 Amp	250
MA-AGC-30	30 Amp	250

BLADE-TYPE FUSES

Fast acting, 32V, DC, UL Listed

5 fuses per tin

Part	Amp
MA-ATC2	2
MA-ATC3	3
MA-ATC4	4
MA-ATC5	5
MA-ATC7.5	7-1/2
MA-ATC10	10
MA-ATC15	15
MA-ATC20	20
MA-ATC25	25
MA-ATC30	30

32 VOLT DC

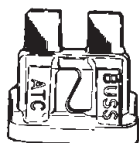

GLASS FUSES

250 VOLT

Time Delay, 250V/32V

1/4" x 1-1/4"

5 fuses per tin

Part	Amp	Volts
MA-MDL-1/4	1/4	250
MA-MDL-1/2	1/2	250
MA-MDL-3/4	3/4	250
MA-MDL-1	1	250
MA-MDL-1-1/4	1-1/4	250
MA-MDL-2	2	250
MA-MDL-2-1/2	2-1/2	250
MA-MDL-3	3	250
MA-MDL-3.2	3-2/10	250



Part	Amp	Volts
MA-MDL-4	4	250
MA-MDL-5	5	250
MA-MDL-6	6	250
MA-MDL-7	7	250
MA-MDL-8	8	250
MA-MDL-10	10	32
MA-MDL-15	15	32
MA-MDL-20	20	32
MA-MDL-25	25	32
MA-MDL-30	30	32

SUPPLEMENTARY FUSES

Time delay, 250 Volts, 13/32" x 1-1/2", UL Listed, CSA Certified

Standard package of 10

Part	Amp
MA-FNM10	10
MA-FNM12	12
MA-FNM15	15
MA-FNM20	20
MA-FNM25	25
MA-FNM30	30
MA-FNM35	35
MA-FNM40	40

250 VOLT



CLASS G FUSE

Time delay, 480V, UL Listed, CSA Certified

Standard package of 10

Part	Amp	Part	Amp
MA-SC10	10	MA-SC35	35
MA-SC15	15	MA-SC40	40
MA-SC20	20	MA-SC45	45
MA-SC25	25	MA-SC50	50
MA-SC30	30	MA-SC60	60

480 VOLT



SUPPLEMENTARY FUSES

Time delay, 500 Volts, 13/32" x 1-1/2" UL Listed, CSA Certified

Standard package of 10

Part	Amp
MA-FNQ10	10
MA-FNQ12	12
MA-FNQ15	15
MA-FNQ20	20
MA-FNQ25	25
MA-FNQ30	30

500 VOLT



IN-LINE FUSE HOLDER

FOR FUSING CONTROL CIRCUITS UP TO 30 AMPS

Part	Wire Range	Pkg
MA00014-1	18 gauge wire with 15 AMP fuse	2
MA00030-1	12 gauge wire with 30 AMP fuse	2

FUSE PULLERS



Part	Description	MA-7519
MA-7519	Fuse Puller, overall length 7" 1/2" diameter one end, 3/8" diameter other end. cartridge type fuses, 0 to 200A, 250V	

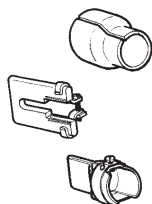

FUSE REDUCER

Sold 1 pair per carton

Part	Description
MA-263-R	For Class R Fuses, 250 Volt Fuse Size 30A—Desired Size 60A
MA-263	For Class H & K Fuses, 250 Volt Fuse Size 30A—Desired Size 60A
MA-213	Fuse Reducer

QUIET SWITCHES

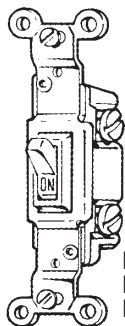

MA-7600
MA-7601
MA-7648

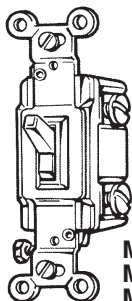

MA-7602
MA-7603
MA-7649

Individually
Packaged

Horsepower Rated
for Motor Loads
Rated 120V AC Max. Amps
15A 1/2HP 12A

UL APPROVED ONLY

Part	Description
MA-7600	Single Pole, 15A, 115V Switch Brown
MA-7601	Single Pole, 15A, 115V Switch Ivory
MA-7648	Single Pole, 15A, 115V Switch White
MA-7602	Three Way, 15A, 115V Switch Brown
MA-7603	Three Way, 15A, 115V Switch Ivory
MA-7649	Three Way, 15A, 115V Switch White

DUPLEX SWITCHES

UL Approved Only

Individually
Packaged

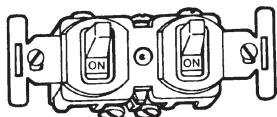

MA-7624
MA-7650
MA-7651



MA-7626
MA-7654
MA-7655

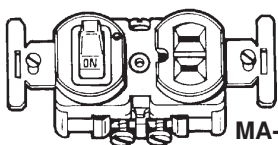

MA-7625
MA-7652
MA-7653

Part	Description
MA-7624	Single Pole, 15A, 120-277V AC Switch, Ivory
MA-7650	Single Pole, 15A, 120-277V AC Switch, Brown
MA-7651	Single Pole, 15A, 120-277V AC Switch, White
MA-7625	Single Pole, 15A, 120-277V AC Switch, 2P 3W Grounding, 15A 125V Receptacle Ivory
MA-7652	Single Pole, 15A, 120-277V AC Switch, 2P 3W Grounding 15A, 125V Receptacle, Brown
MA-7653	Single Pole, 15A, 120-277V AC Switch, 2P 3W Grounding 15A, 125V Receptacle, White
MA-7626	Single Pole 15A 120-277V AC Switch w/Pilot Lite 120V Ivory
MA-7654	Single Pole 15A, 120-277V AC Switch with Pilot Lite 120V, Brown
MA-7655	Single Pole 15A, 120-277V AC Switch with Pilot Lite 120V, White

PROTECTIVE COVER

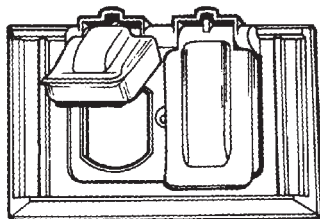

UL & CSA
Approved

Part	Description
MA-7621	Duplex Receptacle for Wet Locations Plastic Snap Covers

HEAVY DUTY QUIET SWITCHES

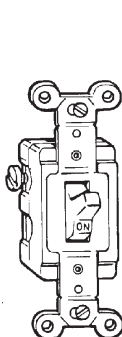

MA-7605
MA-7606
MA-7657

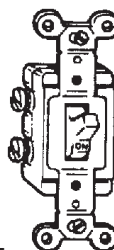

MA-7604
MA-7656
MA-7607
MA-7608
MA-7658
MA-7611

Individually
Packaged

UL Approved Only

Rated	Horsepower Rated for Motor Loads		
	120V AC	240V AC	Max. Amps
15A	1/2 HP	1 HP	12A
20A	1 HP	2HP	16A

Part	Description
MA-7604	Double Pole, 20A, 120-277V AC Switch Brown
MA-7656	Double Pole, 20A, 120-277V AC Switch White
MA-7605	Single Pole, 20A, 120-277V AC Switch Brown
MA-7606	Single Pole, 20A, 120-277V AC Switch Ivory
MA-7657	Single Pole, 20A, 120-277V AC Switch, White
MA-7607	Three Way, 20A, 120-277V AC Switch Brown
MA-7608	Three Way, 20A, 120-277V AC Switch Ivory
MA-7658	Three Way, 20A, 120-277V AC Switch White
MA-7611	Double Pole, 20A, 120-277V AC Switch Ivory

GFI DUPLEX RECEPTACLE

UL Approved Only

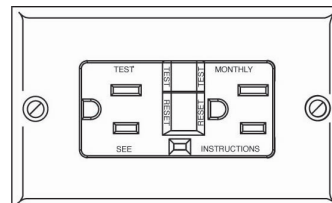

MA-7518

Part	Description
MA-7518	Duplex Receptacle, Ground Fault Circuit Interrupters 15A 125V Nema 5-15, White

DRYER AND RANGE RECEPTACLES



MA-7670

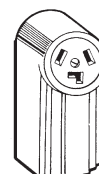

MA-7671

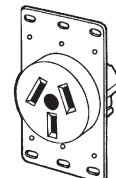

MA-7672

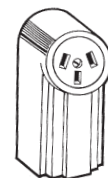

Part	Description
MA-7670 UL APPROVED	Flush Mount 30A 125/250V Nema 10-30 Dryer Receptacle Brown 3-Prong
MA-7671 UL APPROVED	Surface Mount 30A 125/250V Nema 10-30 Dryer Receptacle Black 3-Prong
MA-7672 UL & CSA APPROVED	Flush Mount 50A 125/250V Nema 10-50 Range Receptacle Black 3-Prong
MA-7673 UL APPROVED	Surface Mount 50A 125/250V Nema 10-50 Range Receptacle Black 3-Prong
MA-1257 UL & CSA APPROVED	Flush Mount 30A 125/250V Nema 14-30 Receptacle 4 Prong Black
MA-1225 UL APPROVED	Surface Mount 30A 125/250V Nema 14-30 Receptacle 4 Prong Black
MA-1258 UL & CSA APPROVED	Flush Mount 50A 125/250V Nema 14-50 Receptacle 4 Prong Black
MA-1212 UL & CSA APPROVED	Surface Mount 50A 125/250V Nema 14-50 Receptacle 4 Prong Black

STEEL COVERS

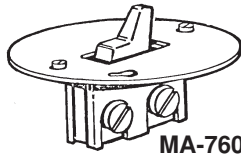

MA-7609

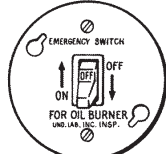

MA-7610

Part	Description
MA-7609	Aluminum Sprayed, 4" Rd. w/Toggle
MA-7610	Red, Oil Burner, 4" Rod w/Toggle

STRAIGHT BLADE RECEPTACLES

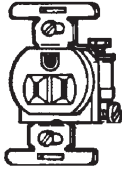

MA-7614
MA-7615
MA-7662

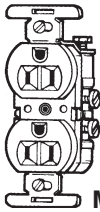

MA-7514
MA-7515
MA-7661

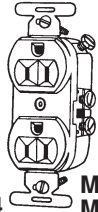

MA-7612
MA-7613
MA-7659

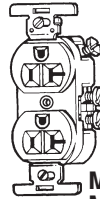

MA-7617
MA-7618
MA-7660

E-Z Ground Strap w/grounding terminal screw. Suitable for grounded metallic or non-metallic systems. Terminal screws are large head, staked, and backed out. Compact design provides more wiring space in outlet box. UL File E15058RTRT

Part	Description
MA-7612 UL&CSA APPROVED	Side Wire, 2P,3W Grounding 15A, 125V, Nema 5-15R, Duplex Receptacle, Brown
MA-7613 UL&CSA APPROVED	Side Wire, 2P,3W Grounding 15A 125V, Nema 5-15R, Duplex Receptacle, Ivory
MA-7659 UL APPROVED	Side Wire, 2P,3W Grounding 15A, 125V, Nema 5-15R, Duplex Receptacle, White
MA-7614 UL APPROVED	Single, Brown, 15A, 125V, NEMA 5-15R, 2-5/8" Long
MA-7615	Single Ivory, 15A, 125V, Nema 5-15R
MA-7662	Single White, 15A, 125V Nema, 5-15R
MA-7617 UL APPROVED	Side Wire, 2P,3W Grounding 20A, 125V, Nema 5-10R, Duplex Receptacle, Brown
MA-7618 UL APPROVED	Side Wire, 2P,3W Grounding 20A, 125V, Nema 5-20R, Duplex Receptacle, Ivory
MA-7660 UL APPROVED	Side Wire, 2P,3W, Grounding 20A, 125V Nema 5-10R Duplex Receptacle White
MA-7514 UL APPROVED	E-Z Wire & Screw, 15A, 125V Nema 5-15R, Duplex Receptacle, Brown
MA-7515 UL APPROVED	E-Z Wire & Screw 15A, 125V, Nema 5-15R, Duplex Receptacle, Ivory
MA-7661 UL APPROVED	E-Z Wire & Screw, 15A, 125V Nema 5-15R, Duplex Receptacle, White

WALL PLATES

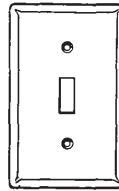

MA-7630
MA-7631
MA-7663

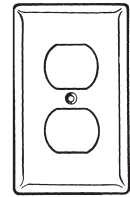

MA-7632
MA-7633
MA-7664

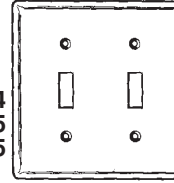

MA-7634
MA-7635
MA-7665

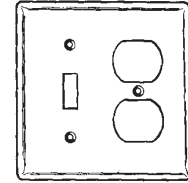

MA-7636
MA-7637
MA-7667

Part	Description
MA-7630	One Gang Toggle, Smooth Line Brown
MA-7631	One Gang Toggle, Smooth Line, Ivory
MA-7663	One Gang Toggle, Smooth Line, White
MA-7632	Duplex, Smooth Line Brown
MA-7633	Duplex, Smooth Line Ivory
MA-7664	Duplex, Smooth Line, White
MA-7634	Two Gang Toggle Smooth Line, Brown
MA-7635	Two Gang Toggle Smooth Line, Ivory
MA-7665	Two Gang Toggle Smooth Line, White
MA-7636	Toggle & Duplex Smooth Line, Brown
MA-7637	Toggle & Duplex Smooth Line, Ivory
MA-7667	Toggle & Duplex Smooth Line, White
MA-7668	Blank, Brown, Plastic
MA-7669	Blank, Ivory, Plastic
MA-7674	Blank, White, Plastic

TOGGLE SWITCHES



INDIVIDUALLY PACKAGED

20A at 125 Vac All Double Pole Rated
10A at 250 Vac All Double Pole Rated
1.5HP at 125/250 Vac
All Toggle Switches Furnished with Screw Terminals

20A at 125 Vac All Single Pole Rated
10A at 250 Vac All Single Pole Rated
3/4 HP at 125/250 Vac

Part	Description
MA04501-2	SP-ST Toggle Switch
MA04502-2	SP-DT Toggle Switch
MA04503-2	SP-DT Center-Off Toggle Switch
MA04504-2	DP-ST Toggle Switch
MA04505-2	DP-DT Toggle Switch
MA04506-2	DP-DT Center-Off Toggle Switch

STRAIGHT BLADE PLUGS, CONNECTORS, AND ADAPTORS

INDIVIDUALLY PACKAGED



MA-179ED



MA-7525

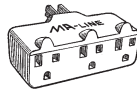

MA-7599



MA-7638



MA-7639



MA-7642



MA-7643



MA-7644



MA-7645



MA-7640



MA-7641

Part	Description
MA-179ED UL & CSA APPROVED	Plastic Handle Plug 15A-125V, 2-pole 2-wire 13/32" cord hole, 2/bag
MA-7525 UL APPROVED	3 Wire Receptacle to 3 Wire Grounding Outlet Vinyl Gray 15A 125V
MA-7599	Tri-Tap, 15A, 125V, Nema 1-15
MA-7638 UL & CSA APPROVED	Vinyl Plug 20A 125V Nema 5-20, Yellow
MA-7639 UL APPROVED	Vinyl Plug Connectors 20A 125V Nema 5-20 Yellow
MA-7640 UL & CSA APPROVED	Vinyl Armored Connectors 15A 125V Nema 5-15, Yellow
MA-7641 UL & CSA APPROVED	Vinyl Armored Plugs 15A 125V Nema 5-15, Yellow

Part	Description
MA-7642 UL & CSA APPROVED	Vinyl Armored Connectors 15A 250V Nema 6-15, Yellow
MA-7643 UL & CSA APPROVED	Vinyl Armored Plugs 15A 250V Nema 6-15, Yellow
MA-7644 UL & CSA APPROVED	Vinyl Armored Plugs 20A 250V Nema 6-20, Yellow
MA-7645	Vinyl Armored Connectors 20A 250V Nema 6-20, Yellow
MA-7646 UL APPROVED	Rubber Round, Round Handle Connectors 15A 125V Nema 5-15, Black
MA-7647 UL & CSA APPROVED	Rubber Plug, Round Handle 15A 125V Nema 5-15, Black



MA-7646



MA-7647

4" SQUARE TWO DEVICE OUTLET BOXES

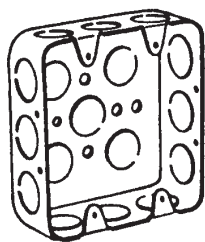

WITH 1/2" KNOCKOUTS

Part	Description	Pkg.
MA-E374	4" - 1-1/2" Deep Box	50
MA-E374D	4" - 2-1/8" Deep Box	25

4" COVERS FOR TWO DEVICE BOXES

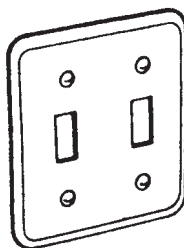

MA-E272

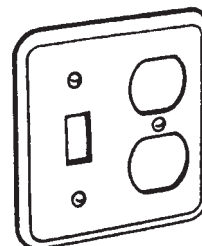

MA-E273

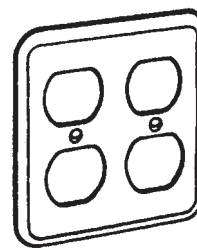

MA-E274

Part	Description	Pkg.
MA-E272	For 2-Toggle Switches	50
MA-E273	For 1-Toggle Switch and 1-Duplex Receptacle	50
MA-E274	For 2-Duplex Receptacle	50

SQUARE OUTLET BOXES

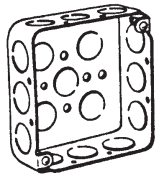

MA-E352

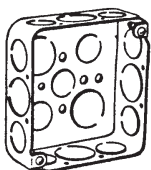

MA-E353

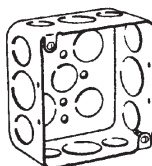

MA-E353D

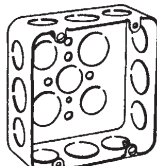

MA-E363D

Part	Description	Pkg.
MA-E352	4" - 1-1/4" Deep Square Box 1/2" Knockouts	50
MA-E353	4" - 1-1/2" Deep Square Box 1/2" & 3/4" Knockouts	50
MA-E353D	4" - 2-1/8" Deep Square Box 1/2" & 3/4" Knockouts	25
MA-E363D	4 11/16" - 2-1/8" Deep 1/2" & 3/4" Knockouts	25

EXTENSION RINGS

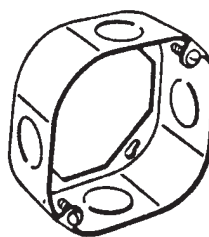

MA-E304EXT

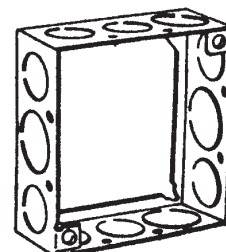

MA-E350EXT

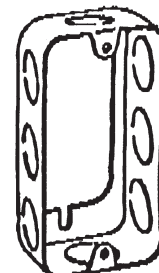

MA-E200EXT

Part	Description	Pkg.
MA-E304EXT	4" Octagon Ring Only 1-1/2"D-4-1/2" Knockouts	50
MA-E350EXT	4" Square Ring Only 1-1/2"D 8-1/2" & 4-3/4" Knockouts	50
MA-E200EXT	Extension Ring for 4" L x 2 1/8" W Box	50

4" OCTAGON BOXES



MA-E303

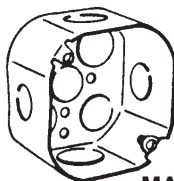

MA-E303D

Part	Description	Pkg.
MA-E303	4" - 1-1/2" Deep Octagon Box 1/2" & 3/4" Knockouts	50
MA-E303D	4" - 2-1/8" Deep Octagon Box 1/2" & 3/4" Knockouts	25

STANDARD UTILITY BOXES

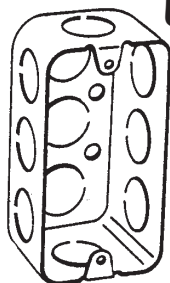

MA-E200
MA-E201
MA-E202

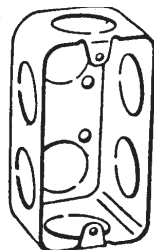

MA-E201 - 3/4"

Part	Description	Pkg.
MA-E200	4"L x 2-1/8" W x 1-1/2"D Std. Utility Box 1/2" K.O.	50
MA-E201	4"L x 2-1/8" W x 1-7/8" D Std. Utility Box 1/2" K.O.	50
MA-E202	4"L x 2-1/8"W x 2-1/8"D Std. Utility Box 1/2" K.O.	50
MA-E201-3/4	4"L x 2-1/8"W x 1-7/8"D Std. Utility Box 3/4" K.O.	50

COVERS FOR 4-11/16" SQUARE OUTLET BOXES

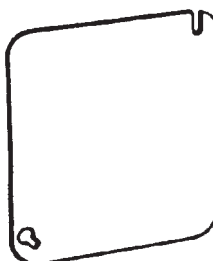

MA-E584

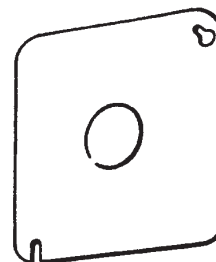

MA-E594

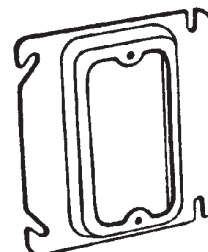

MA-E590

Part	Description	Pkg.
MA-E584	4-11/16" Square Flat, Blank Cover	25
MA-E590	4-11/16" Square Cover 1/2" Raised, Single Device K.O in Center	25
MA-E594	4-11/16" Square Cover K.O in Center	25

COVERS FOR 4" OCTAGON BOXES

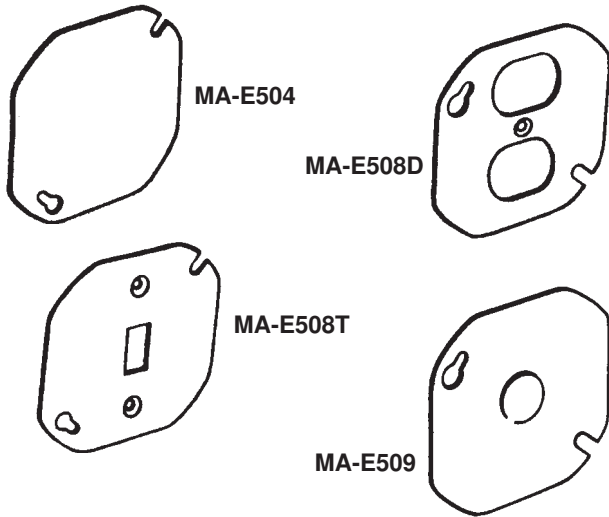

Part	Description	Pkg
MA-E504	4" Octagon flat blank cover	50
MA-E508D	4" Octagon duplex receptacle cover	50
MA-E508T	4" Octagon flat/toggle switch cover	50
MA-E509	4" Octagon cover with 1/2" knockout center	50

COVERS FOR 4" SQUARE BOXES

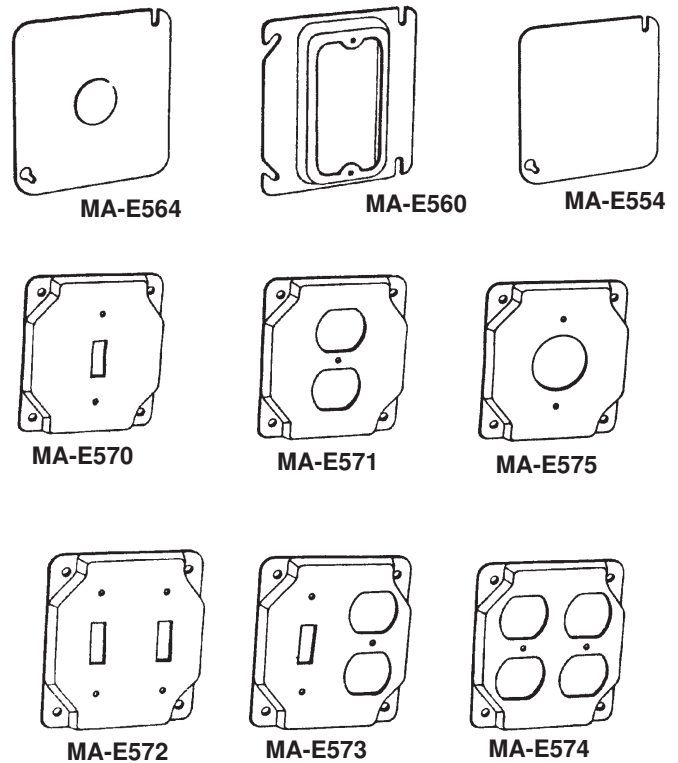

Part	Description	Pkg
MA-E554	4" Square flat blank cover	50
MA-E560	4" Square, 1/2" Raised for single flush	50
MA-E564	4" Square cover, 1/2" K.O. in center	50
MA-E570	4" Square, 1/2" Raised cover, one toggle switch	50
MA-E571	4" Square, 1/2" Raised cover, one duplex receptacle	50
MA-E572	4" Square, 1/2" Raised cover, two toggle switch	50
MA-E573	4" Square, 1/2" Raised cover, one switch & duplex receptacle	50
MA-E574	4" Square, 1/2" Raised cover, two duplex receptacle	50
MA-E575	4" Square, Raised one single receptacle hole, 1 13/32"	50

STANDARD HANDY BOX COVERS

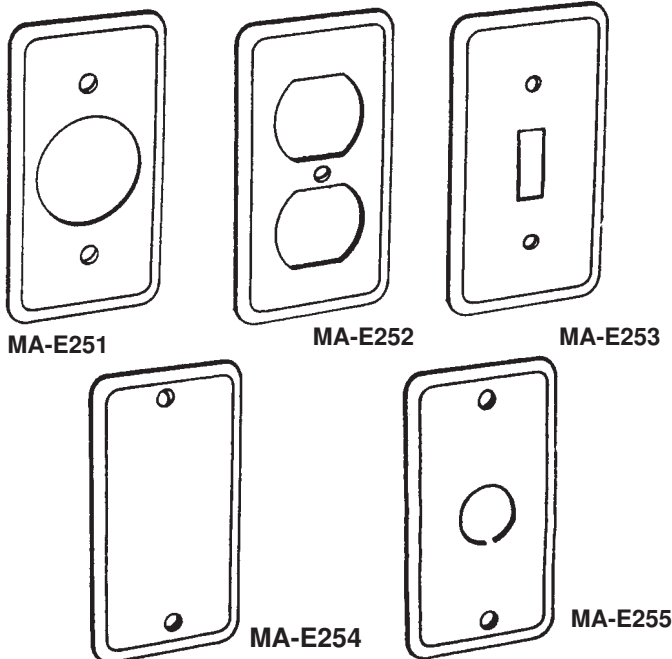

Part	Description
MA-E251	4"L x 2 1/8" W Cover, Single Receptacle
MA-E252	4"L x 2 1/8"W Cover, Duplex Receptacle
MA-E253	4"L x 2 1/8"W Cover, Toggle Switch
MA-E254	4"L x 2 1/8"W Cover, Blank
MA-E255	4" x 2 1/8"W Cover, 1 1/2" knockout

ANTI-SHORT BUSHINGS

For Flex-AC-MC Cable Thermoplastics

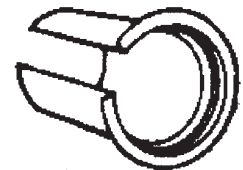

Part	Description	Trade Size	Pkg
MA-E0PL	Fits cable size, 14/2, 14/3, 12/2	5/16"	100
MA-E1PL	Fits cable size 14/4, 12/3, 6/1, 4/1	3/8"	100
MA-E2PL	Fits cable size 12/4, 10/2, 10/3, 2/1	7/16"	50
MA-E3PL	Fits cable size 10/4, 8/2, 8/3, 1/1	1/2"	50
MA-E4PL	Fits cable size 8/4, 6/2, 6/3, 6/4, 4/2, 4/3	3/4"	50

METAL FITTINGS FOR LIQUID TIGHT

FOR USE WITH METALLIC OR NON-METALLIC LIQUID TIGHT CONDUIT
TYPE B DIE CAST ZINC ALUMINUM

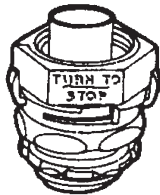

TYPE "A"

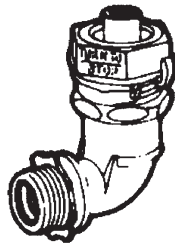

TYPE "B"

Part	Description	Type	Pkg.
MA-E50A	1/2" Straight Liquid Tight Connector	A	25
MA-E75	3/4" Straight Liquid Tight Connector	A	25
MA-E100	1" Straight Liquid Tight Connector	A	5
MA-LT125	1-1/4" Straight Liquid Tight Connector	A	5
MA-LT150	1-1/2" Straight Liquid Tight Connector	A	2
MA-E5090A	1/2" 90 deg. Liquid Tight Connector	B	25
MA-E7590	3/4" 90 deg. Liquid Tight Connector	B	25
MA-E10090	1" 90 deg. Liquid Tight Connector	B	5
MA-E12590	1-1/4" 90 deg. Liquid Tight Connector	B	2
MA-E15090	1-1/2" 90 deg. Liquid Tight Connector	B	2

MA-4E50A	1/2" Straight Connector	A	4
MA-4E75	3/4" Straight Liquid Tight Connector	A	4
MA-4E5090A	1/2" 90 deg. Elbow	B	4
MA-4E7590	3/4" 90 deg. Liquid Tight Connector	B	4
MA-4E59A	1/2" Assortment Liquid Tight Fittings Consists of 2 ea: MA-E50A and MA-E5090A	AB	4
MA-4E79A	3/4" Assortment Liquid Tight Fittings Consists of 2 ea: MA-E75 and MA-E7590	AB	4

CABLE STRAPS AND INSULATED STAPLES



TYPE "A"



TYPE "B"

Part	Description	Type	Pkg.
MA-E2PL-1	2-Nail Straps f/2 & 3 Wire NM Cable up to #12, 2 Wire UF Cable up to #12, 1/2" Wide	A	100
MA-E3PL-1	2- Nail straps f/2 Wire NM and UF Cable up to #8, 3 wire UF Cable up to #12, 3/4" Wide	A	100
MA-E2PL25	Insulated Staples 1/2" Same as above	A	25
MA-E3PL25	Insulated Staples 3/4" Same as above	A	25
INSULATED STAPLES COPPERED			
MA-E27325	Insulated Staple 5/8" x 1/4" coppered	B	25
MA-E273-100	Insulated Staple 5/8" x 1/4" coppered	B	100

NON-METALLIC LIQUID TIGHT FITTINGS

UL LISTED



TYPE "A"

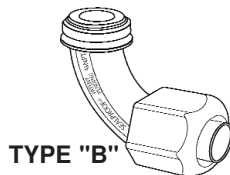

TYPE "B"

Part	Description	Type	Pkg.
MA-LC43D	1/2" Straight Connector, screw on	A	25
MA-LC43E	3/4" Straight Connector, screw on	A	25
MA-NMLT50	1/2" Straight Connector	C	10
MA-NMLT75	3/4" Straight Connector	C	10
MA-LC20D	1/2" 90 degree Elbow, screw on	B	10
MA-LC20E	3/4" 90 degree Elbow, screw on	B	10
MA-NMLT9050	1/2" 90 degree Elbow	D	10
MA-NMLT9075	3/4" 90 degree Elbow	D	10

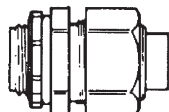

TYPE "C"

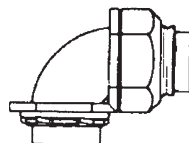

TYPE "D"

MA-4LC43D	1/2" Straight Connector, screw on	A	4
MA-4LC43E	3/4" Straight Connector, screw on	A	4
MA-4NMLT50	1/2" Straight Connector	C	4
MA-4NMLT75	3/4" Straight Connector	C	4
MA-4LC20D	1/2" 90 degree Elbow, Screw on	B	4
MA-4LC20E	3/4" 90 degree Elbow, Screw on	B	4
MA-4NMLT9050	1/2" 90 degree Elbow	D	4
MA-4NMLT9075	3/4" 90 degree Elbow	D	4

FITTINGS FOR THINWALL CONDUIT (E.M.T.)

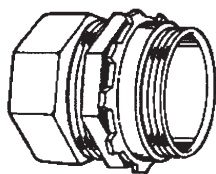

TYPE "A"

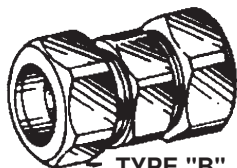

TYPE "B"

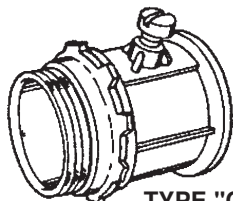

TYPE "C"

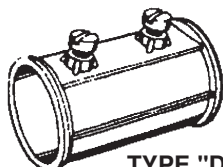

TYPE "D"

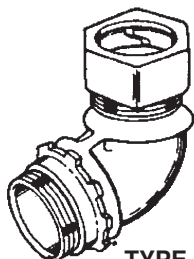

TYPE "E"



TYPE "F"

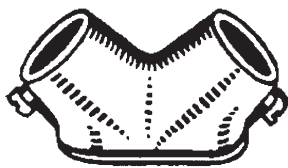

TYPE "G"



TYPE "H"



Part	Description	Type	Pkg.
MA-E21	1/2" Compression Type Connectors Thinwall (E.M.T.) Rain Tight	A	50
MA-E23	3/4" Compression Type Connectors Thinwall (E.M.T.) Rain Tight	A	25
MA-E25	1" Compression Type Connectors Thinwall (E.M.T.) Rain Tight	A	15
MA-E27	1-1/4" Compression Type Connectors Thinwall (E.M.T.) Rain Tight	A	5
MA-E29	1-1/2" Compression Type Connectors Thinwall (E.M.T.) Rain Tight	A	10
MA-E22	1/2" Compression Type Couplings Thinwall (E.M.T.) Rain Tight	B	50
MA-E24	3/4" Compression Type Couplings Thinwall (E.M.T.) Rain Tight	B	25
MA-E26	1" Compression Type Couplings Thinwall (E.M.T.) Rain Tight	B	15
MA-E28	1-1/4" Compression Type Couplings Thinwall (E.M.T.) Rain Tight	B	10
MA-E30	1-1/2" Compression Type Couplings Thinwall (E.M.T.) Rain Tight	B	10
MA-E121	1/2" E.M.T. Set Screw Type Connector (concrete tight)	C	50
MA-E123	3/4" E.M.T. Set Screw Type Connector (concrete tight)	C	25
MA-E125	1" E.M.T. Set Screw Type Connector (concrete tight)	C	20
MA-E127	1-1/4" E.M.T. Set Screw Type Connector (concrete tight)	C	5
MA-E129	1-1/2" E.M.T. Set Screw Type Connector (concrete tight)	C	10
MA-E122	1/2" E.M.T. Set Screw Type Coupling (concrete tight)	D	50
MA-E124	3/4" E.M.T. Set Screw Type Coupling (concrete tight)	D	25
MA-E126	1" E.M.T. Set Screw Type Coupling (concrete tight)	D	15
MA-E128	1-1/4" E.M.T. Set Screw Type Coupling (concrete tight)	D	20
MA-E130	1-1/2" E.M.T. Set Screw Type Coupling (concrete tight)	D	10
MA-E2390-2	3/4" 90 deg. Thinwall (E.M.T.) Connectors	E	20
MA-E37-1	1/2" Offset Connectors (E.M.T.) to Box	F	20
MA-E37-2	3/4" Offset Connectors (E.M.T.) to Box	F	10
MA-E37-3	1" Offset Connectors (E.M.T.) to Box	F	10
MA-E144-1	1/2" E.M.T. Pull Elbows	G	10
MA-E144-2	3/4" E.M.T. Pull Elbows	G	5
MA-E5S	1/2" Steel Drive Straps	H	100
MA-E7S	3/4" Steel Drive Straps	H	100
MA-E10S	1" Steel Drive Straps	H	100
MA-4E21	1/2" Compression Type Connector	A	4
MA-4E23	3/4" Compression Type Couplings	A	4
MA-4E22	1/2" Compression Type Couplings	B	4
MA-4E24	3/4" Compression Type Couplings	B	4
MA-4E121	1/2" Set Screw Type Connector	C	4
MA-4E123	3/4" Set Screw Type Connector	C	4
MA-4E122	1/2" Set Screw Type Couplings	D	4
MA-4E124	3/4" Set Screw Type Couplings	D	4
MA-2E1441	1/2" E.M.T. Pull Elbows	G	2
MA-2E1442	3/4" E.M.T. Pull Elbows	G	2

FITTINGS FOR BX-FLEXIBLE METAL CONDUIT

DIE CAST ZINC ALUMINUM

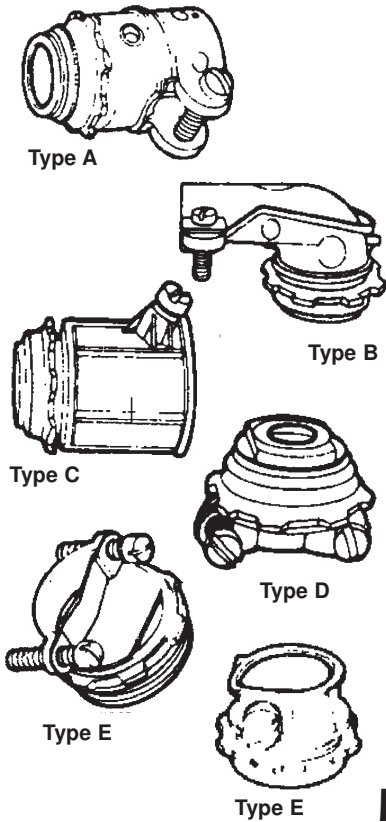

FOR FLEX, AC, MC CABLE, FOR STEEL AND ALUMINUM FLEX

Part	Description	Type	Pkg.
MA-E42-1	1/2" Straight Squeeze Connectors	A	25
MA-E42-2	3/4" Straight Squeeze Connectors	A	25
MA-E42-3	1" Straight Squeeze Connectors	A	10
MA-E42-4	1-1/4" Straight Squeeze Connectors	A	10
MA-E42-5	1-1/2" Straight Squeeze Connectors	A	5
MA-E110	3/8" 90 deg. Screw Clamp Connector	B	50
MA-E110-1	1/2" 90 deg. Screw Clamp Connector	B	25
MA-E110-2	3/4" 90 deg. Screw Clamp Connector	B	15
MA-E110-3	1" 90 deg. Screw Clamp Connector	B	10
MA-E110-4	1-1/4" 90 deg. Screw Clamp Connector	B	5
MA-E110-5	1-1/2" 90 deg. Screw Clamp Connector	B	1

FOR NM CABLE

MA-E104A	3/4" Cable Connector	E	50
MA-E105	1" Cable Connector	E	25
MA-E106	1-1/4" Cable Connector	E	10
MA-E107	1-1/2" Cable Connector	E	10

FOR FLEX, MC, AC CABLE

MA-E58	3/8" Set Screw Connector	F	100
MA-E48	1/2" Set Screw Connector	C	25

FOR NM, MC, AC, FLEX CABLE, FOR STEEL & ALUMINUM JACKETED CABLES

MA-E57	3/8" Combination Connector	D	100
MA-E51	3/8" Romex Connector for NM cable	E	100
MA-4E421	1/2" Straight Squeeze Connectors	A	4
MA-4E422	3/4" Straight Squeeze Connectors	A	4
MA-4E110	3/8" 90 deg. Screw Clamp Connector	B	4
MA-4E1101	1/2" 90 deg. Screw Clamp Connector	B	4
MA-4E1102	3/4" 90 deg. Screw Clamp Connector	B	4
MA-4E51	3/8" Romex Connector	E	4
MA-4E104A	3/4" Cable Connector	E	4
MA-4E58	3/8" Set Screw Connector	F	4
MA-4E48	1/2" Set Screw Connector	C	4
MA-4E57	3/8" Combination Connector	D	4

FITTINGS FOR RIGID CONDUIT

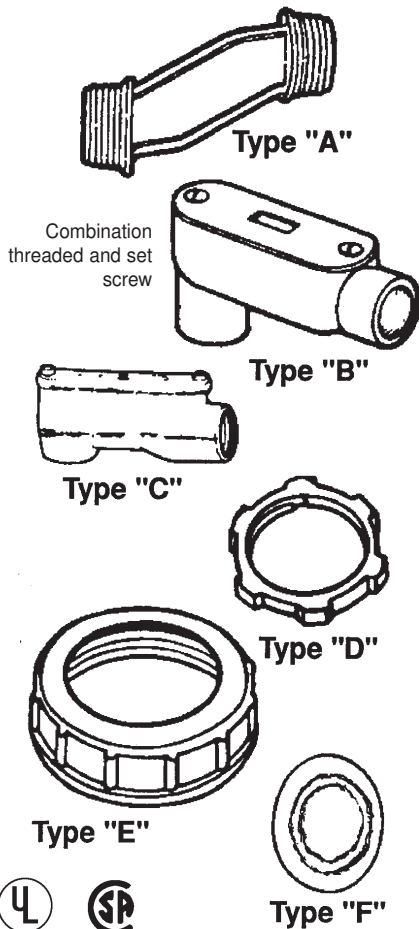

Part	Description	Type	Pkg.
MA-E376	1/2" Offset nipples f/rigid conduit	A	20
MA-E377	3/4" Offset nipples f/rigid conduit	A	10
MA-E378	1" Offset nipples f/rigid conduit	A	10
MA-E379	1-1/4" Offset nipples f/rigid conduit	A	10
MA-E380	1-1/2" Offset nipples f/rigid conduit	A	10
MA-E96-1CG	1/2" Threaded oval conduit body (Type LB) with cover and gasket	B	10
MA-E96-2CG	3/4" Threaded oval conduit body (Type LB) with cover and gasket	B	10
MA-E96-3CG	1" Threaded oval conduit body (Type LB) with cover and gasket	B	5
MA-E96-4CG	1-1/4" Threaded oval conduit body (Type LB) with cover and gasket	B	2
MA-E96-5CG	1-1/2" Threaded oval conduit body (Type LB) with cover and gasket	B	2
MA-E900	1/2" SLB service entrance ells	C	10
MA-E901	3/4" SLB service entrance ells	C	10
MA-E902	1" SLB service entrance ells	C	5
MA-E903	1-1/4" SLB service entrance ells	C	5
MA-E904	1-1/2" SLB service entrance ells	C	2
MA-E59	1/2" Conduit locknuts fully reversible	D	200
MA-E80	3/4" Conduit locknuts fully reversible	D	100
MA-E81	1" Conduit locknuts fully reversible	D	100
MA-E82	1-1/4" Conduit locknuts fully reversible	D	50
MA-E83	1-1/2" Conduit locknuts fully reversible	D	50
MA-E52PL	1/2" Plastic insulating bushings	E	100
MA-E60PL	3/4" Plastic insulating bushings	E	100
MA-E61PL	1" Plastic insulating bushings	E	50
MA-E65PL	1-1/4" Plastic insulating bushings	E	25
MA-E69PL	1-1/2" Plastic insulating bushings	E	25
MA-E298-21	3/4" x 1/2" Reducing washer	F	250
MA-E298-31	1" x 1/2" Reducing washer	F	100
MA-E298-32	1" x 3/4" Reducing washer	F	100
MA-E298-41	1-1/4" x 1/2" Reducing washer	F	200
MA-E298-42	1-1/4" x 3/4" Reducing washer	F	200
MA-E298-43	1-1/4" x 1" Reducing washer	F	200
MA-E298-51	1-1/2" x 1/2" Reducing washer	F	100
MA-E298-52	1-1/2" x 3/4" Reducing washer	F	100
MA-E298-53	1-1/2" x 1" Reducing washer	F	100
MA-E298-54	1-1/2" x 1-1/4" Reducing washer	F	100
MA-25E59	1/2" Conduit locknuts	D	25
MA-25E80	3/4" Conduit locknuts	D	25
MA-25E29821	3/4" x 1/2" Reducing washer	F	25
MA-25E29831	1" x 1/2" Reducing washer	F	25
MA-25E29832	1" x 3/4" Reducing washer	F	25

**LIQUID TIGHT
NON-METALLIC CONDUIT
U.L. AND CSA LISTED**



Part	Description
MA-15005	1/2" x 100' Liquid Tight
MA-15007	3/4" x 100' Liquid Tight
MA-15008	1" x 100' Liquid Tight

**FLEXIBLE
CONDUIT**

**LIQUID TIGHT
TYPE ULC
U.L. APPROVED ONLY**

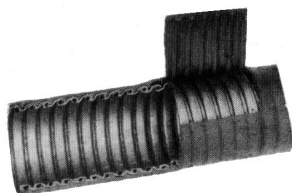

Part	Description
MA-10050	1/2" x 100' Liquid Tight
MA-10075	3/4" x 100' Liquid Tight
MA-10010	1" x 100' Liquid Tight

**TYPE MC
ALUMINUM CLAD CABLE
WITH INSULATED GREEN GROUND WIRE**

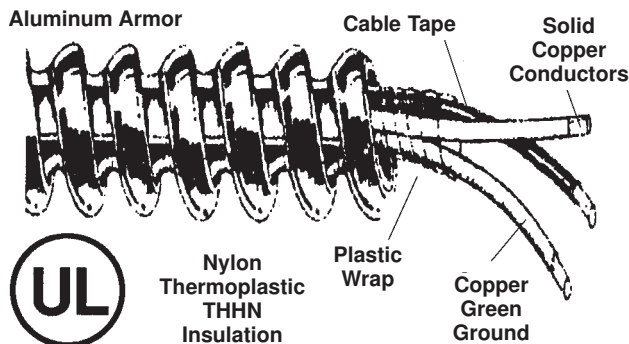

MA-Line Type MC Cable is used in commercial, industrial, and utility applications where space and ease of installation is critical. MC Cable handles power service, lighting, control and signal circuits. May be used in cable trays, approved raceways, or as an open run of cable. Made of aluminum interlocked armor, solid copper conductors. 600 volts - THHN conductors with green insulated ground. Meets U.L. 1569.

Part	Description
MA-MC42C	14-2 100' Roll
MA-MC22C	12-2 100' Roll
MA-MC43C	14-3 100' Roll
MA-MC23C	12-3 100' Roll

Due to the fluctuation in the copper metal market, prices are subject to change without notice.

**HEAT SHRINK
TUBING**



Bulk packs available upon request.

Available in convenient assortment packs or individual sizes.

Part	Description	Pcs/pk	Length
ASSORTMENT PACKS			
MA00478-1	3/16", 1/4" 3/8"	8	4"
MA00479-1	1/2", 3/4" 1"	5	4"
MA00480-1	1/16" thru 1"	7	4"
INDIVIDUAL PACKS			
MA03383-1	1/8"	10	4"
MA03385-1	3/16"	8	4"
MA03387-1	1/4"	7	4"
MA03389-1	3/8"	6	4"
MA03391-1	1/2"	5	4"
MA03393-1	3/4"	4	4"
MA03394-1	1"	3	4"

FLEXIBLE CONDUIT

**LIQUID TIGHT
TYPE EFC
NON-U.L.**

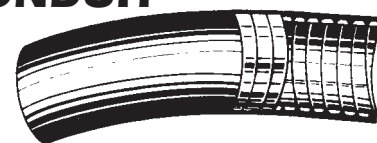

Meets JIC requirements.
Does not contain continuous copper ground.

Part	Description
MA-20050	1/2" x 100' (boxed) Liquid Tight
MA-20075	3/4" x 100' (boxed) Liquid Tight
MA-20010	1" x 100' (boxed) Liquid Tight

**FLEXIBLE CONDUIT
ALUMINUM AND STEEL**



Part	Description
MA-30038	3/8" x 100' Aluminum (Greenfield)
MA-30050	1/2" x 100' Aluminum (Greenfield)
MA-30075	3/4" x 100' Aluminum (Greenfield)
MA-40038	3/8" x 100' Steel (Greenfield)
MA-40050	1/2" x 100' Steel (Greenfield)
MA-40075	3/4" x 100' Steel (Greenfield)

**TERMINAL BLOCKS AND
JUMPERS**



MA-6182 thru MA-6187 Series are UL recognized for 20 amp (250 volt commercial equipment), fits the same space as a 15 amp strip. Recommended max. wire size 14 terminal width 7/8" screw size 6.

MA-6192 thru MA-6197 are UL recognized for the 30 amp (800 V. commercial equipment). Recommended max. wire size 12 terminal width 1-5/16". Screw size 8.

Part	Description
MA-6182	Double Row 4 Terminal 20 Amp Block 2.2" Long
MA-6183	Double Row 6 Terminal 20 Amp Block 2.9" Long
MA-6184	Double Row 8 Terminal 20 Amp Block 3.7" Long
MA-6185	Double Row 10 Terminal 20 Amp Block 4.4" Long
MA-6186	Double Row 12 Terminal 20 Amp Block 5.2" Long
MA-6187	Double Row 14 Terminal 20 Amp Block 5.9" Long
MA-6188	Jumpers for 20 Amp. Terminal Block 10/pkg
MA-6192	Double Row 4 Terminal 30 Amp Block 3.2" Long
MA-6193	Double Row 6 Terminal 30 Amp Block 4.3" Long
MA-6194	Double Row 8 Terminal 30 Amp Block 5.5" Long
MA-6195	Double Row 10 Terminal 30 Amp Block 6.6" Long
MA-6196	Double Row 12 Terminal 30 Amp Block 7.7" Long
MA-6197	Double Row 14 Terminal 30 Amp Block 8.8" Long
MA-6198	Jumpers for 30 Amp. Terminal Block 10/Pkg

UNIT COOLERS FOR REFRIGERATED CABINETS

MEDIUM TEMPERATURE — AIR DEFROST

Model No.	BTU/Hr 10° T.D.	Dimensions			CFM	Fan Dia.	Mtr Amps	Connections			Approx. Ship Wt.
		H.	W.	D.				Liquid	Suction	Drain	
MALS-55	550	5	10	14	125	5-1/2	.50	1/2 FN	1/2 OD	1/2 OD	9
MALS-105	1050	5	16-1/2	14	125	5-1/2	.50	1/2 FN	1/2 OD	1/2 OD	12
MALS-135	1350	5	20-1/2	14	200	(2) 5-1/2	1.00	1/2 FN	1/2 OD	1/2 OD	16
MALS-180	1800	5	24-1/2	15	225	(2) 5-1/2	1.00	1/2 FN	1/2 OD	1/2 OD	17
MALS-240	2400	6-5/8	24	16-1/2	300	8	.80	1/2 FN	1/2 OD	1/2 OD	23
MALS-310	3100	8	30-5/8	20-3/8	400	10	.80	1/2 FN	5/8 OD	5/8 MF	36
MALS-400	4000	7-1/2	38	18-1/4	600	(2) 8	1.60	1/2 FN	5/8 OD	5/8 MF	44

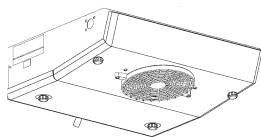

COATED COILS

Part

- MALS-55-P
- MALS-105-P
- MALS-135-P
- MALS-180-P

Specifications for the coated coils are the same as above.

- Low silhouette design for maximum use of shelf area
- Textured aluminum cabinet.
- Moisture-proof wiring harness.
- Full-hard temper aluminum fins and seamless copper tubing
- Drain pan and bottom panel are one piece for easy servicing
- Easily adapted as a replacement unit or original equipment
- Durable polycarbonate fans and fan guards: MALS-55, MALS-105, and MALS-135
- Aluminum fans and plated steel fan guards: MALS-180, MALS-240, MALS-310, and MALS-400
- Thermally protected, permanently lubricated motors
- Expansion valve mounts inside cabinet.
- UL recognized; NSF approved.
- External equalized expansion valve recommended (external equalizer tube field installed)

LOW TEMPERATURE — ELECTRIC DEFROST

Model No.	BTU/Hr 10° T.D.	Dimensions			CFM	Fan Dia.	Mtr. Amps	Heaters		Connections			Approx. Ship Wt.
		H.	W.	D.				Amps	Watts	Liquid	Suction	Drain	
MALS-50E1	500	5	10	14	125	5-1/2	.50	1.80	215	1/2 FN	1/2 OD	1/2 OD	10
MALS-95E1	950	5	16-1/2	14	125	5-1/2	.50	3.30	480	1/2 FN	1/2 OD	1/2 OD	13
MALS-125E1	1250	5	20-1/2	14	200	(2) 5-1/2	1.00	4.31	495	1/2 FN	1/2 OD	1/2 OD	17
MALS-160E1	1600	5	24-1/2	15	225	(2) 5-1/2	1.00	5.05	580	1/2 FN	1/2 OD	1/2 OD	19
MALS-210E1	2100	6-5/8	24	16-1/2	300	8	.80	7.52	865	1/2 FN	1/2 OD	1/2 OD	24
MALS-210E2	2100	6-5/8	24	16-1/2	300	8	.22	3.83	880	1/2 FN	1/2 OD	1/2 OD	24
MALS-280E1	2800	8	30-5/8	20-3/8	400	10	.80	9.80	1125	1/2 FN	5/8 OD	5/8 MF	38
MALS-280E2	2800	8	30-5/8	20-3/8	400	10	.22	4.90	1125	1/2 FN	5/8 OD	5/8 MF	38
MALS-360E2	3600	7-1/2	38	18-1/4	600	(2) 8	.44	6.10	1400	1/2 FN	5/8 OD	5/8 MF	47
MALS-540E2	5400	7-1/2	50	18-1/4	800	(3) 8	.66	8.00	1850	1/2 FN	5/8 OD	5/8 MF	145

E1 MODELS 115/60/1 E2 MODELS 230/60/1

- Low silhouette design for maximum use of shelf area.
- High quality, easily replaceable tubular heaters with moisture proof, odor free, molded neoprene sealed ends.
- Positive contact between heaters and drain pan eliminates freeze-up.
- Defrost termination switch and fan delay control insures defrost without overheating.
- Durable polycarbonate fans and fan guards: MALS-50E – 160E
- Aluminum fans and plated steel fan guards: MALS210E - 540E
- UL recognized; NSF approved.
- External equalized expansion valve recommended (external equalizer tube field installed.)

MEDIUM TEMPERATURE — AIR DEFROST

Model No.	BTU/Hr 10° T.D.	Dimensions			CFM	Fan Dia.	Mtr. Amps	Connections			Approx. Ship Wt.
		H.	W.	D.				Liquid	Suction	Drain	
MASF-105	1000	9	11-3/8	14	180	8	.80	1/2 FN	3/8 OD	1/2 OD	14
MASF-135	1300	9	14-3/8	14	225	8	.80	1/2 FN	3/8 OD	1/2 OD	16
MASF-175	1700	9	17-3/8	14	290	8	.80	1/2 FN	3/8 OD	1/2 OD	18
MASF-235	2300	9-7/8	20-3/8	15	400	8	.80	1/2 FN	1/2 OD	1/2 OD	22
MASF-305	3000	11	23-3/8	16	500	10	1.09	1/2 FN	1/2 OD	1/2 OD	27

STANDARD 115/60/1 (230/60/1 OPTIONAL)

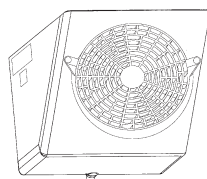

COATED COILS

Part

- MASF-105-P
- MASF-135-P
- MASF-175-P
- MASF-235-P
- MASF-305-P

Specifications for coated coils are the same as above.

- Compact unit for ceiling Mounting.
- Drain pan and bottom panel are one piece for easy servicing.
- Textured aluminum cabinet.
- Exclusive "Off-Center" construction reduces the number of welded return bends. "Where there are no joints, there are no leaks."
- Full-hard temper aluminum fins and seamless copper tubing.
- Easily adapted as a replacement unit or original equipment.
- Aluminum fans and plated steel fan guards.
- Thermally protected, permanently lubricated motors.
- Moisture-proof wiring harness
- Expansion valve mounts inside cabinet.
- UL recognized. NSF approved.
- External equalized expansion valve recommended (external equalizer tube field installed.)

Unit cooler specifications may change without notice

MEDIUM TEMPERATURE — AIR DEFROST

Model No.	BTU/Hr 10° T.D.	Dimensions			CFM	Fan Dia.	Mtr. Amps	Connections			Approx. Ship Wt.
		H.	W.	D.				Liquid	Suction	Drain	
MAMJ-40	400	7	13-5/8	8	140	5-1/2	.50	1/2 FN	3/8 OD	1/2 OD	7
MAMJ-70	700	7	13-5/8	8	140	5-1/2	.50	1/2 FN	3/8 OD	1/2 OD	9
MAMJ-90	900	7	13-5/8	9	140	5-1/2	.50	1/2 FN	3/8 OD	1/2 OD	10
MAMJ-120	1200	7	20-5/8	9	250	(2) 5-1/2	1.00	1/2 FN	3/8 OD	1/2 OD	15

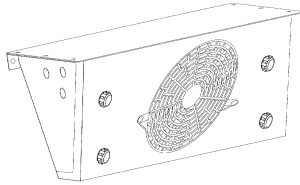

COATED COILS Part

- MAMJ-40-P
- MAMJ-70-P
- MAMJ-90-P
- MAMJ-120-P

- Compact unit for ceiling or wall mounting.
- Front panel and drain pan are one piece for easy servicing.
- Textured aluminum cabinet.
- Exclusive "Off-Center" construction reduces the number of welded joints. "Where there are no joints, there are no leaks."
- Full-hard temper aluminum fins and seamless copper tubing.
- Easily adapted as a replacement unit or original equipment.
- Durable polycarbonate fans and fan guards.
- Thermally protected, permanently lubricated motors.
- Moisture-proof wiring harness.
- Expansion valve mounts inside cabinet.
- UL recognized. NSF approved.

MEDIUM TEMPERATURE — AIR DEFROST

Model No.	BTU/Hr 10° T.D.	Dimensions			CFM	Fan Dia.	Mtr. Amps	Connections			Approx. Ship Wt.
		H.	W.	D.				Liquid	Suction	Drain	
MATM-100	1000	4-5/8	20-3/8	16	150	5-1/2	.50	1/2 FN	3/8 FN	1/2 OD	11
MATM-135	1350	4-5/8	20-3/8	16	250	(2) 5-1/2	1.00	1/2 FN	3/8 FN	1/2 OD	15
MATM-180	1800	4-5/8	20-3/8	16	250	(2) 5-1/2	1.00	1/2 FN	3/8 FN	1/2 OD	15
MATM-250	2500	5-5/8	20-3/8	16	300	8	.80	1/2 FN	3/8 FN	1/2 OD	16

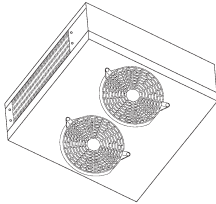

COATED COILS Part

- MATM-100-P
- MATM-135-P
- MATM-180-P
- MATM-250-P

- Low silhouette design for ceiling mounting.
- Two-way air discharge for maintaining uniform box temperature.
- Textured aluminum cabinet.
- Exclusive "Off-Center" construction reduces the number of welded joints. "Where there are no joints, there are no leaks."
- Full-hard temper aluminum fins and seamless copper tubing.
- Moisture-proof wiring harness.
- Easily adapted as a replacement unit or original equipment.
- Durable polycarbonate fans and fan guards: MATM-100, MATM-135, MATM-180.
- Aluminum fan and plated steel fan guard: MATM-250
- Thermally protected, permanently lubricated motors.
- Expansion valve mounts inside cabinet.
- UL recognized; NSF approved.

UNIT COOLERS FOR REFRIGERATED ROOMS

MEDIUM TEMPERATURE — AIR DEFROST

Model No.	BTU/Hr 10° T.D.	Dimensions			CFM	Fan Dia.	Mtr. Amps	Connections			Approx. Ship Wt.
		H.	W.	D.				Liquid	Suction	Drain	
MAPLP-380	3800	13-1/2	22-1/2	12-1/4	600	10	1.70	1/2 FN	5/8 OD	1 FPT	35
MAPLP-500	5000	13-1/2	27	12-1/4	600	10	1.70	1/2 FN	5/8 OD	1 FPT	38
MAPLP-600	6000	13-1/2	33	12-1/4	600	10	1.70	1/2 FN	7/8 OD	1 FPT	46
MAPLP-750	7500	13-1/2	38	12-1/4	1200	(2) 10	3.40	1/2 FN	7/8 OD	1 FPT	55
MAPLP-1000	10000	13-1/2	45	12-1/4	1200	(2) 10	3.40	1/2 FN	7/8 OD	1 FPT	67
MAPLP-1500	15000	13-1/2	63	12-1/4	1800	(3) 10	5.10	1/2 FN	7/8 OD	1 FPT	90
MAPLP-2000	20000	13-1/2	81	12-1/4	2400	(4) 10	6.80	1/2 FN	1-1/8 OD	1 FPT	120
MAPLP-2500	25000	13-1/2	99	12-1/4	3000	(5) 10	8.50	1/2 FN	1-1/8 OD	1 FPT	155
MAPLP-3000	30000	13-1/2	117	12-1/4	3600	(6) 10	10.20	1/2 FN	1-1/8 OD	1 FPT	180

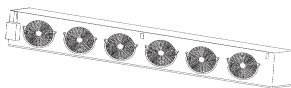

- For medium temperature walk-in storage rooms.
- Low silhouette height of only 13-1/2 inches.
- Flush ceiling mounted.
- UL recognized, NSF approved
- Removable side panel and hinged drain pan for easy servicing.
- Textured aluminum cabinet.
- Aluminum fins and seamless copper tubing.
- Easily adapted as a replacement unit or original equipment.
- Aluminum fan blades and plated steel fan guards.
- Thermally protected, permanently lubricated motors.
- Factory wired for convenience.
- Junction box outside cabinet for easy hook-up.

LOW TEMPERATURE — ELECTRIC DEFROST

Model No.	BTU/HR 10° T.D.				Dimensions			CFM	Fan Dia.	Mtr. Amps	Heaters		Connections				Approx. Ship Wt.
	Evaporator +20°	Suction -10°	Suction -20°	Suction -30°	H.	W.	D.				Amps	Watts	Liquid	Suction	Drain		
MAPLP-430E	5000	4400	4300	3950	13-1/2	27	12-1/4	600	10	.83	4.48	1030	1/2 FN	5/8 OD	1 FPT	38	
MAPLP-640E	7500	6600	6400	5920	13-1/2	38	12-1/4	1200	(2) 10	1.66	6.24	1435	1/2 FN	7/8 OD	1 FPT	55	
MAPLP-860E	10000	8800	8600	7900	13-1/2	45	12-1/4	1200	(2) 10	1.66	7.24	1665	1/2 FN	7/8 OD	1 FPT	67	
MAPLP-1290E	15000	13200	12900	11850	13-1/2	63	12-1/4	1800	(3) 10	2.49	12.35	2840	1/2 FN	7/8 OD	1 FPT	90	
MAPLP-1720E	20000	17600	17200	15800	13-1/2	81	12-1/4	2400	(4) 10	3.32	16.41	3775	1/2 FN	1-1/8 OD	1 FPT	120	
MAPLP-2150E	25000	22000	21500	19750	13-1/2	99	12-1/4	3000	(5) 10	4.15	18.84	4330	1/2 FN	1-1/8 OD	1 FPT	155	
MAPLP-2580E	30000	26400	25800	23700	13-1/2	117	12-1/4	3600	(6) 10	4.98	21.20	4875	1/2 FN	1-1/8 OD	1 FPT	180	

Standard 230/60/1 • External equalized expansion valve required • (1/4" dia. external equalizer tube provided)

- For low-temperature walk-in storage rooms.
- Low silhouette height of only 13-1/2 inches.
- Heaters are UL approved, moisture proof, odor and taste free, with molded neopreen sealed ends.
- Easily adapted as a replacement unit or original equipment.
- Flush ceiling mounted.
- Serpentine tubular heating elements are evenly spaced for ideal defrosting.
- Defrost termination switch and fan delay control insures defrost without overheating.
- UL listed; NSF approved.

Unit cooler specifications may change without notice

INDEX

- A**
- Access Fittings18
 - Adaptor Kit, Quick Change25
 - Adaptors27
 - Air Conditioning Covers51
 - Air Conditioning Whips77
 - Air Deflectors46
 - Air Flow Meter, Digital10
 - Air Tubing35
 - Alligator Clips, Low Voltage67
 - Aluminum Foil Tape49
 - Aluminum Tubing35
 - Anchor Kits
 - Plastic70
 - Self Drilling70
 - Anti-Short Bushings86
 - Anti-Vibration Pads34
 - Assorted Wire Ties71
- B**
- Band Heater, Refrigerant Cylinder37
 - Batteries65
 - Bird & Pest Guard46
 - Boiler Gauges35
 - Books
 - Modern Refrigeration & Air Conditioning31
 - Doolins Trouble Shooters Bible31
 - Doolins Spanish Edition31
 - Borescope68
 - Box Cover Units, Bussman68,81
 - Breakaway Brass Fittings35
 - Brushes
 - Boiler41
 - Cleaning41
 - Condenser and Heat Exchanger40
 - Condenser Tube42
 - Copper Tube Fitting39
 - Extensions40
 - Flue and Furnace41
 - Flux and Acid40
 - New Parts Cleaning42
 - Nylon Tube41
 - Oil or Chip42
 - Radiator Cleaning42
 - Refrigerator Coil Cleaning42
 - Varnish42
 - Vent Brush, Clothes Dyer42
 - Welders Toothbrush40
 - Wire42, 43
 - Buckets & Bucket Organizers43
- C**
- Cable, Metal Clad90
 - Cable Clamps Nylon72
 - Cable Straps and Insulated Staples87
 - Calipers Dial, Digital, Steel33
 - Capacitor Testor11
 - Capillary Tube Cutter19
 - Carbon Monoxide Detector10
 - Caulk
 - High Temp Red Silicone60
 - Silicone60
 - Caulking Guns60
 - Cement
 - Black Flashing50
 - Furnace Cement50
 - Chisel Scraper32
 - Circuit Breakers
 - Siemens Dual79
- C (Continued)**
- Circuit Breakers continued
 - Replacement for Square D-Style79
 - Siemens79
 - Square D (QO & Homeline Style)79
 - Circuit Testers66, 68
 - Clamps46
 - Clamp on adaptor3
 - Clipboards, Form Holders31
 - Compressor
 - Grommets32
 - Hook-Up Kits67
 - Condenser Fan Rain Shields48
 - Condensor Fin Whisk Brook42
 - Condensate Pans56
 - Condensate Traps57
 - Condenser Cleaning Tool23
 - Conduit
 - Aluminum90
 - Flexible90
 - Liquid Tight90
 - Connectors
 - Butt Splice73
 - Closed End69
 - Contactors78
 - Copper Spun Driers19
 - Copper Straps63
 - Copper Tube Brushes39
 - Cork & Rubber Pads34
 - Cork Tape61
 - Coveralls30
 - Crankcase Heaters37
- D**
- Data Loggers9
 - De-Burring Tool22
 - Defrost Thermostats19
 - Delrin Sleeve & Brass Insert52
 - Diffusers45
 - Digital Refrigerant Pressure and Temperature Chart8
 - Disconnects, Air Conditioning
 - Metal77
 - Non-Metallic77
 - Three Phase77
 - Drain Heater, Universal56
 - Drain Hose53
 - Drain Line Elbows53
 - Drain Pan Safety Switch56
 - Driers, Copper Spun19
 - Drill Sets25
 - Dryer & Range Receptacles83
 - Dryer Vent
 - Aluminum46
 - Wide Mouth Hood46
 - Duct Tape
 - Aluminum Foil49
 - Silver & Black49
 - Duct Ties, Natural, Black71
 - Ducts
 - Metallic46
 - Semi-Rigid Aluminum46
 - Dust Masks30
- E**
- Electrical Tape72
 - Electrical Pocket Testers66
 - Evacuation Quick Pierce Tool22
 - Extension Cords
 - All-Weather66
 - Air Conditioning66
 - Handi-Tap 3-Outlet66
 - Outdoor66
 - Extension Rings85
- F**
- Fan Blade Pitch Gauge47
 - Fan Blades
 - OEM Direct, Hub Style47
 - Plastic, Replacement Vent Hood47
 - Fin Combs23
 - Firestop Products
 - Sealant60
 - First Aid Kit43
 - Fittings
 - For BX-Flexible Metal Conduit89
 - For Liquid Tight, Metal87
 - For Rigid Conduit89
 - For Thinwall Conduit (EMT)88
 - Non-Metallic Liquid Tight Fitting87
 - Nylon54, 55
 - SCH 40 PVC,DWV58
 - Black59
 - Flame Shields38
 - Flare Nut Wrench Set27
 - Flashing Cement50
 - Flashlights
 - LED64
 - Maglights Flashlights64
 - Maglights Accessories, Holsters64
 - Maglight Replacement Bulbs64
 - Food Grade Hose53
 - Flood Alert15
 - Flux Brushes40
 - Foam Sealant50
 - Foam Tape61
 - Freeze Alert15
 - Furnace Block49
 - Furnace Cement50
 - Furnace Lighter, Telescopic29
 - Fuse Adaptor, Type S81
 - Fuse Holder, In-Line68
 - Fuse Pullers82
 - Fuse Reducer82
 - Fuses
 - Blade-Type82
 - Ceramic82
 - Class G Fuse82
 - Dual Element, Time Delay80
 - Glass82
 - Heating and Air Conditioning80
 - One Time81
 - S Plug81
 - SL & TL Plug81
 - Supplementary82
 - T Plug81
 - W Plug81

G

Gas Ball Valves	.34
Gas Connectors, Flexible	.34
Gasket Material	.32
Gasket Scraper	.32
Gauge Boots, Protective	.51
Gauges	
Heating System Boiler Gauges	.35
Gas Pressure Test Gauge	.35
Gloves	
Disposable	.30
Work	.30
Glycol Refractometer	.36
Grease	.32
Grease Guns, Accessories	.32
Grills	.45
Grommet Kit, Rubber	.48
Grommets	.72

H

Hacksaws, Blades	.33
Hanger Strap, Plastic	.62
Hanging Wire	.63
Hard Starts, Extra Boost	.77
Heat Guns	.37
Heat Pump Stands	.49
Hex Key Adapter	.27
Hex Key Sets	.22
Holesaw Kits	.23
Hose Clamps	.56
Hose Cutter, Vinyl and Garden	.53
Hose, Garden	.52
Hub Puller	.23
Humidifier Hook Up Kit	.52
Humidity/Temperature Tester	.9

I

Ice Maker & Humidifier Hook Up Kits	.52
Infrared Thermometers	.6,7
Infrared Thermometer and Flashlight Combination	.7
Infrared Thermometer and Pressure Temperature Chart Combination	.8
In-Line Splice	.68,82
Insulation Tester	.8

J

J-Hook Hanger	.62
---------------	-----

K

Knife Sharpener	.28
Knives	
Ductboard Knife & Sheath	.28
Pocket, Stainless Steel	.28
Utility Cutter	.28

L

Labels	
Re-Claimed Refrigerant ID	.39
Refrigerant Label Assortment	.39
Safe for Disposal	.39
Laser Tape Measure	.12
LED Flashlights	.64
Levels	.29

L (Continued)

Light Bulbs	.66
Line Voltage Cord Adaptors	.67
Liquid Level Switches for Recovery Cylinders	.37
Locking Pinch-Off Tool	.22,26
Louvers	.51
Lug Mounting Bracket	.48

M

Magna-Lite	.65
Magnetic Assorted Bits	.24
Magnetic Parts Tray	.75
Manometers	.10
Marking Pens	.51
Masks, Particle and Dust Mask	.30
Maxicap Covers	.34
Megohmmeter	.8
Metal Fittings for Liquid Tight	.87
Metallic Duct	.46
Meters	

5 in 1 (Environmental)	.2
AC/DC Digital Multimeter w/Auto Selection	.2
Analog Multi-Meter	.3
Analog Clamp on	.3
Auto-Ranging Multi-Meter	.1
Clamp on for Flame Safeguard Circuits	.4
Digital Clamp On Meters	.4,5
Digital Multi-Meters	.1,2,3
Open Jaw	.5
Pen Probe Style	.6
True RMS Clamp On	.5
True RMS Multi-Meter	.2

Microwave Leak Detector	.12
Mirrors	
Glass, Telescoping	.29
Replacement Glass	.29
Stainless Steel, Telescoping	.29
Moisture Indicator	.12
Mounting Bracket	.48
Mounting Bracket, Rheem	.48
Mounting Cables, Rheem	.48
Mounting Pads	
Natural Rubber	.34
Motor & Phase Indicator	.9
Multi-Bit & Driver Kit	.25
Multi-Tool, Mini-Pocket	.27

N

Natural Gas Indicator	.12
Neoprene Tubing	.35
Nipples	
Black Welded	.59
Nipple Tote Tray (Cardboard)	.60
Nipple Tray	.60
Nozzle, Water	.52
Nuts	.49
Nut Driver Set	.22
Nut Kits	.70
Nylon Insert Lock Nut Kit	.70
Nylon Carry All Pouch	.13

O

Oil Pump	.32
Oil Refractometer	.36
O'Ring Kit	.70
Outlet Boxes	.85
Outlet Box Covers	.85,86

P • Q

Perforated Strap, Galvanized & Copper	.62
Pen Probe Style	.6
Phase Rotation Indicator	.11
Pick Up Tools	.29
Pipe Clamps	.63
Pipe Clamp Temperature Lead	.3
Pipe Fittings	
Malleable Black Iron	.59
Pipe Hangers	.63
Pipe Joint Compound	.61
Pipe Nipples	
Welded Steel, Black Iron	.59
Pipe Wrenches	.33
Pipes & Elbows, Aluminum	.46
Piping Thermometer	.16
Plastic Hanger Strap	.62
Plastic Sprayers	.52
Pliers	
Convertible Snap Ring	.26
Pliers Plus	.27
Standard	.26
Tongue and Groove	.26
Pressure Switches (High & Low)	.19
Propane Gas Indicator	.12
Protective Cover	.83
Psychrometer (Digital)	.8,9
Pump Stands	.49
Putty Knife	.32
PVC Cement	.57
PVC Pipe Cutter	.57
PVC Wire Cutter/Saw	.57

R

R-410A Adapter	.22
Reamer	.22
Receptacles, Straight Blade	.84
Refractometers, Glycol & Oil	.36
Refrigerant Recovery Cylinders	.37
Refrigerant Recovery Tool	.22
Refrigerant & Temperature Digital Chart	.8
Registers	.45
Relay/Overload Combination	.67
Replacement Power Supply Cord	.66
Roof Flashings, Masterflash	.50
Rope, Polypropylene	.31
Rubber Straps	.31
Rubber Vibration Pads	.34

S

Sand Cloth & Pads	.38
Scales	
Digital	.36
Hand-Held	.36
Refrigerant	.36
Scissors Sharpener	.28
Screwdriver Bits	
Doubleway	.24
Phillips	.24
PoziDrive	.24
Robertson	.24
Slotted	.24
Tamper Proof	.24
Torq	.24
Screwdrivers	
6-in-1	.25
6-in-1, Heavy Duty Rubber Grip	.25
Offset Screwdriver Sets	.22
Screws	
Sheet Metal, Plated	.62

S (Continued)

Sheet Metal Screw Kit	.70
Set Screw Kit	.70
Screwstarters	.29
Scribe	.29
SealGum,Cords & Putty	.61
Sensors AC, Low Voltage AC	.68
Shoe Covers	.30
Shop Towels	.30
Shop Wipes	.30
Sidekick, Condenser Cleaner	.23
Silicone Tubing	.35
Smoke Cartridges	
Gray Smoke	.61
White Smoke	.61
Snips	.33
Solenoid Voltage Testor	.67
Sprayers-Plastic	
Pump Style	.52
Trigger	.52
Steel Covers	.84
Storage Drawers	
Metal	.75
Plastic	.75
Strainers, Plastic Y	.53
Straps	
Nylon Straps	.31
Perforated	.62
Rubber Straps	.31
Stud Sensor	.12
Superheat Instrument	.8
Swaging Tool	.22
Switches	.83

T

Tachometer	.12
Tanks	.37,38
Tape	
Aluminum	.49
Cork	.61
Duct	.49
Electrical	.72
Foam	.61
Splicing	.72
Thread Sealing (Teflon)	.57
Tape Measures	.33
Tape Measure Laser	.12
Terminal Blocks and Jumpers	.90
Terminal Kits	.70
Terminals	
90 deg Disconnect w/ screw	.74
Butt Connectors	.73
Compressor	.74
Flag Disconnect	.74

T (Continued)

High Temperature	.73
Quick Disconnect Insulated	.74
Ring Insulated	.73
Spades Insulated	.74
Special Device	.74
Ring Non-Insulated	.73
Spade Non-Insulated	.73
Disconnect Non-insulated	.73
Test Leads	
Adaptors	.67
Low Voltage	.67
With Start Switch	.67
Thermometers	
Digital Alarm	.13
Digital, Hand-Held	.13
Digital Stem	.14
Dual Probe	.13
Indoor/Outdoor	.16
Infrareads	.6,7,8
Horizontal	.17
Non-Solar	.17
Piping	.16
Pocket Dial	.14
Pocket Digital	.14,15
Pocket Hygrometers	.15
Pocket Stick	.15
Rotary Probe	.13
Refrigerator/Freezer/Oven	.16
Solar Powered	.17
Solar Powered, Remote Reading	.17
Vapor Tension, Remote Reading	.17
Thermostat Covers	.44
Thermostats Defrost	.19
Threaded Rod	.49
Time Delays	.77
Toggle Switches	.84
Tool Bag	.43
Tool Cases	.43
Tools	.22,23,25,26,27,28,33
Torches Self Igniting, Bernzomatic	.38
Towels	.30
Transformers	.78
Trouble Lights	.65
Tubing	
Air-Neoprene	.35
Aluminum	.35
Clear Vinyl	.53
Drain - Heavy Duty PVC Braied	.53
Heat Shrink	.90
Polyethylene	.53
Silicone	.35

U

Unit Coolers	
Refrigerated Cabinets	.91,92

U (Continued)

Refrigerated Rooms	.91,92
Utility Boxes	.85
Utility Cutters	.28

V

V-Belts	.47
Vacuum/Charge Valve & Core Tool	.22
Vent Hoods	.46
Vibration Eliminators	.20,21
Vibration Pads	.34
Video Borescope	.Inside Front Cover
Vise-Grips Locking Hand Tools	.26
Voltage Testers	.6,68

W . X . Y . Z

Wall Plates	.84
Washers	.49
Washing Machine Pans	.56
Water Heater Pans	.56
Water Line tap valves	.52
Wattmeter	.11
Whips	.77
Window Unit Covers	.51
Wire	
THHN Stranded, THHN Solid	.76
Glass Braided Silicon Rubber	.76
Polyethylene Range	.76
Motor Hook Up	.76
Wire Connectors	
Assortment	.69,70
Porcelain	.69
Soft Wire, Scotchlocks	.69
Twiston Spring Grip	.69
Winged	.69
Wire Marker ID System, Dispenser, Book	.68
Wire Pipe Hangers	.63
Wire Strippers	.26
Wire Tie Installation Guns	.72
Wire Ties	
Assorted Wire Ties in a Jar	.71
Black Nylon	.71
Mounting Cradle	.71
Natural/White	.71
Screwdown Nylon	.71
Work Belts	.91
Worklights	
Trouble Lights	.65
Wrenches	
Adjustable	.26
Flare Nut	.27
Offset	.27
Pipe, Aluminum & Steel	.27
Service, Straight & Offset	.27

NUMERICAL INDEX

PART #	PAGE	PART #	PAGE	PART #	PAGE	PART #	PAGE	PART #	PAGE	PART #	PAGE
181SP-02	35	33329	19	8910DP32V14	78	AF3140	18	AMA-502	40	AMA-924	39
181SP-03	35	33330	19	8910DP32V02	78	AF3142	18	AMA-503	42	AMA-925	39
181SP-04	35	33353	19	8910DP32V09	78	AF3144	18	AMA-504	40	AMA-926	39
181SP-06	35	33354	19	8910DP42V14	78	AF3148	18	AMA-505	42	AMA-927	39
1010FY	21	33355	19	8910DP42V02	78	AMA-001	40	AMA-507	40	AMA-928	39
1212FY	21	33356	19	8910DP42V09	78	AMA-001-10	40	AMA-510	40	AMA-929	39
1258FY	21	33357	19	8910DPA23V14	78	AMA-002	40	AMA-513	40	AMA-930	39
1418FZ	21	33358	19	8910DPA23V02	78	AMA-002-10	40	AMA-516	40	AMA-931	39
1500W6	45	33359	19	8910DPA23V09	78	AMA-003	40	AMA-519	40	AMA-932	39
1500W8	45	33362	19	8910DPA33V14	78	AMA-003-5	40	AMA-522	40	AMA-933	39
1500W10	45	33363	19	8910DPA33V02	78	AMA-007	40	AMA-525	40	AMA-934	39
1800B6	45	33364	19	8910DPA33V09	78	AMA-007-2	40	AMA-528	40	AMA-935	39
1800B8	45	3434FY	21	8910DPA43V14	78	AMA-010	42	AMA-530	41	AMA-936	39
1800B10	45	3458FY	21	8910DPA43V02	78	AMA-015	42	AMA-531	40	AMA-960	39
1A	61	3618FZ	21	9010DPA43V09	78	AMA-017	42	AMA-533	40	AMA-963	39
1P30A24V	78	372W8X8	45	8910DPA53V14	78	AMA-018	42	AMA-539	41	AMA-964	39
1P40A24V	78	372W10X4	45	8910DPA53V02	78	AMA-020	42	AMA-548	41	AMA-965	39
112P30A24V	78	372W10X6	45	8910DPA53V09	78	AMA-026	42	AMA-565	41	AMA-966	39
112P30A120V	78	372W10X8	45	8910DPA63V14	78	AMA-044	40	AMA-582	41	AMA-967	39
112P30A240V	78	372W12X4	45	8910DPA63V02	78	AMA-130	40	AMA-602	40	AMA-968	39
1W3A3	64	372W12X6	45	8910DPA63V09	78	AMA-132	40	AMA-604	40	AMA-969	39
2020FS	21	372W12X8	45	8910DPA73V14	78	AMA-133	40	AMA-607	40	AMA-970	39
2B	61	372W12X12	45	8910DPA73V02	78	AMA-1438	41	AMA-610	40	B5050	53
2P20A24V	78	372W14X6	45	8910DPA73V09	78	AMA-1448	41	AMA-613	40	B6350	53
2P30A24V	78	372W14X8	45	8910DPA93V14	78	AMA-200	41	AMA-616	40	B7550	53
2P30A120V	78	372W14X14	45	8910DPA93V02	78	AMA-206	41	AMA-619	40	D109	19
2P30A240V	78	372W14X20	45	8910DPA93V09	78	AMA-208	41	AMA-622	40	D110	19
2P40A24V	78	372W20X20	45	AF1000	18	AMA-210	41	AMA-625	40	D111	19
2P40A120V	78	372W30X6	45	AF1100	18	AMA-212	41	AMA-628	40	D112	19
2P40A240V	78	382W8X4-R	45	AF11516	18	AMA-214	41	AMA-631	40	D113	19
3015W15-R	45	382W8X6-R	45	AF1200	18	AMA-216	41	AMA-633	40	D114	19
3018W18-R	45	382W8X8-R	45	AF12516	18	AMA-218	41	AMA-702	40	D115	19
3030FS	21	382W10X4-R	45	AF1300	18	AMA-220	41	AMA-704	40	F336	44
3C	61	382W10X6-R	45	AF13516	18	AMA-222	41	AMA-707	40	HOM115	79
3P30A24V	78	382W10X8-R	45	AF1400	18	AMA-224	41	AMA-710	40	HOM120	79
3P30A120V	78	382W12X4-R	45	AF1500	18	AMA-226	41	AMA-713	40	HOM130	79
3P30A240V	78	382W12X6-R	45	AF1600	18	AMA-228	41	AMA-716	40	HOM140	79
3P40A24V	78	382W12X8-R	45	AF1700	18	AMA-232	41	AMA-719	40	HOM150	79
3P40A120V	78	382W14X4-R	45	AF1800	18	AMA-234	41	AMA-722	40	HOM215	79
3P40A240V	78	382W14X6-R	45	AF1900	18	AMA-236	41	AMA-725	40	HOM220	79
3P50A24V	78	382W14X8-R	45	AF2000	18	AMA-254	40	AMA-728	40	HOM230	79
3P50A120V	78	3838FZ	21	AF2000BX	18	AMA-306	41	AMA-731	40	HOM240	79
3P50A240V	78	4040FS	21	AF2100	18	AMA-308	41	AMA-733	40	HOM250	79
3P60A24V	78	413B2X10-R	45	AF2200-M	18	AMA-312	41	AMA-762	41	HOM260	79
3P60A120V	78	413B4X10-R	45	AF1000-50	18	AMA-314	41	AMA-763	41	K23W3A6	64
3P60A240V	78	413B2X12-R	45	AF1100-50	18	AMA-316	41	AMA-765	41	KECR-2032-1	8
3054	37	413B4X12-R	45	AF1200-50	18	AMA-318	41	AMA-816	42	MAXICAP3R	34
3-1723-12	52	5050FS	21	AF1300-50	18	AMA-322	41	AMA-824	39	MAXICAP5R	34
3-1724-18	52	5125	23	AF1400-50	18	AMA-324	41	AMA-825	39	MAXICAP7R	34
32745	19	5252FS	21	AF1500-50	18	AMA-326	41	AMA-826	39	MA-00106	52
32750	19	5300	23	AF1600-50	18	AMA-328	41	AMA-827	39	MA-00205	52
32755	19	5454FY	21	AF1700-50	18	AMA-332	41	AMA-828	39	MA-00304	52
32760	19	5614FZ	21	AF1800-50	18	AMA-334	41	AMA-829	39	MA-002CR	34
32770	19	6060FS	21	AF1900-50	18	AMA-336	41	AMA-830	39	MA-002RR	34
32780	19	6464FS	21	AF2100-25	18	AMA-348	41	AMA-831	39	MA-003CR	34
32790	19	7272FS	21	AF2100-100	18	AMA-405	42	AMA-832	39	MA-003RR	34
33000033S	52	8080FS	21	AF3134	18	AMA-406	41	AMA-833	39	MA-004CR	34
33000083S	52	8910DP22V14	78	AF3135	18	AMA-410	42	AMA-834	39	MA-004RR	34
33000233PS	52	8910DP22V02	78	AF3136	18	AMA-438	41	AMA-835	39	MA-006CR	34
33000244PS	52	8910DP22V09	78	AF3138	18	AMA-481	42	AMA-836	39	MA-006RR	34

PART #	PAGE	PART #	PAGE	PART #	PAGE	PART #	PAGE	PART #	PAGE	PART #	PAGE
MA-012CR	34	MA-167L	30	MA-12004-50	55	MA-12817	1	MA-18975	22	MA-22012	55
MA-012RR	34	MA-171	29	MA-12004-100	55	MA-12819	5	MA-18985	22	MA-22012-25	55
MA-0130T	60	MA-174	29	MA-12010	55	MA-12820	11	MA-19173	22	MA-22012-50	55
MA-018CR	34	MA-174D	29	MA-12010-25	55	MA-12821	11	MA-20SA	81	MA-22012-100	55
MA-018RR	34	MA-175D	29	MA-12010-50	55	MA-12822	5	MA-21/2SA	81	MA-22013	55
MA-0210	23	MA-175E	29	MA-12010-100	55	MA-12823	2	MA-2E1441	88	MA-22013-25	55
MA-0230	23	MA-176E	29	MA-12013	55	MA-12824	5	MA-2E1442	88	MA-22013-50	55
MA-0360	31	MA-179ED	84	MA-12013-25	55	MA-12825	2	MA-25E59	89	MA-22013-100	55
MA-0361	31	MA-185	29	MA-12013-50	55	MA-12826	4	MA-25E80	89	MA-22014	55
MA-0362	31	MA-186	29	MA-12013-100	55	MA-12827	2	MA-25E29821	89	MA-22014-25	55
MA-0363	31	MA-190	30	MA-12032	54	MA-12829	2	MA-25E29831	89	MA-22014-50	55
MA-03532	66	MA-190EL	59	MA-12032-25	54	MA-12830A	10	MA-25E29832	89	MA-22014-100	55
MA-03533	66	MA-190STEL	59	MA-12032-50	54	MA-12830A-S	10	MA-202	28	MA-22031	54
MA-04625	38	MA-192	30	MA-12032-100	54	MA-12832	2	MA-202RB	28	MA-22031-25	54
MA-05028	32	MA-1001S	17	MA-12033	54	MA-12834	8	MA-210BD	65	MA-22031-50	54
MA-0620	64	MA-1001NS	17	MA-12033-25	54	MA-12834CS	8	MA-211BC	65	MA-22031-100	54
MA-09709	66	MA-1001	65	MA-12033-50	54	MA-12835	10	MA-213-AA	65	MA-22048	55
MA-09857	66	MA-1109	31	MA-12033-100	54	MA-12836	8	MA-214-9V	65	MA-22048-25	55
MA-09858	66	MA-1115	31	MA-12034	54	MA-12837	2	MA-215-AAA	65	MA-22048-50	55
MA-1CAP	59	MA-1117	43	MA-12034-25	54	MA-12838	10	MA-213	82	MA-22048-100	55
MA-1CPLG	59	MA-1122	31	MA-12034-50	54	MA-12842	12	MA-263	82	MA-22049	55
MA-1PLG	59	MA-1131	31	MA-12034-100	54	MA-12843	10	MA-263-R	82	MA-22049-25	55
MA-1RR	22,26	MA-1141	31	MA-12035	54	MA-12844	12	MA-290	25	MA-22049-50	55
MA-1T	59	MA-1148	43	MA-12035-25	54	MA-12845	12	MA-2001	65	MA-22049-100	55
MA-1U	59	MA-1132L	30	MA-12035-50	54	MA-128500	37	MA-2001S	17	MA-22064	55
MA-1-12X	36	MA-1200	22	MA-12035-100	54	MA-14012	50	MA-2002S	17	MA-22064-25	55
MA-10DT12	63	MA-1201	22	MA-12052	54	MA-14025	50	MA-2003S	17	MA-22064-50	55
MA-10DT34	63	MA-1202	22	MA-12052-25	54	MA-14050	50	MA-2149L	30	MA-22064-100	55
MA-10CR	26	MA-1212	83	MA-12052-50	54	MA-14051	50	MA-2300	38	MA-22065	55
MA-10WR	26	MA-1225	83	MA-12052-100	54	MA-14052	50	MA-20010	90	MA-22065-25	55
MA-11-12X	50	MA-1238BG	59	MA-12053	54	MA-14053	50	MA-20050	90	MA-22065-50	55
MA-12CAP	59	MA-1245EL	59	MA-12053-25	54	MA-14054	50	MA-20075	90	MA-22065-100	55
MA-12CPLG	59	MA-1257	83	MA-12053-50	54	MA-14055	50	MA-20534	40	MA-22066	55
MA-12PLG	59	MA-1258	83	MA-12053-100	54	MA-14056	50	MA-207013	58	MA-22066-25	55
MA-12T	59	MA-1266T	60	MA-12054	54	MA-14057	50	MA-207030	58	MA-22066-50	55
MA-12U	59	MA-1290EL	59	MA-12054-25	54	MA-15005	90	MA-22002	55	MA-22066-100	55
MA-15SA	81	MA-1290STEL	59	MA-12054-50	54	MA-15007	90	MA-22002-25	55	MA-22112	54
MA-16N	32	MA-1500	38	MA-12054-100	54	MA-15008	90	MA-22002-50	55	MA-22112-25	54
MA-16RR	32	MA-1660	15	MA-12055	54	MA-152540	37	MA-22002-100	55	MA-22112-50	54
MA-16SA	81	MA-1665	15	MA-12056	54	MA-16501	7	MA-22003	55	MA-22112-100	54
MA-101	60	MA-10010	90	MA-12057	54	MA-16505	6	MA-22003-25	55	MA-22113	54
MA-102	60	MA-10050	90	MA-12060	55	MA-16506	6	MA-22003-50	55	MA-22113-25	54
MA-112BG	59	MA-10075	90	MA-12060-25	55	MA-16507	7	MA-22003-100	55	MA-22113-50	54
MA-112CPLG	59	MA-10214	32	MA-12060-50	55	MA-16509A	6	MA-22005	55	MA-22113-100	54
MA-114	29	MA-10218	32	MA-12060-100	55	MA-16510	7	MA-22005-25	55	MA-22114	54
MA-132A	33	MA-10344	35	MA-12353	3	MA-16512	7	MA-22005-50	55	MA-22114-25	54
MA-134BG	59	MA-10345	35	MA-12355	3	MA-16512P	7	MA-22005-100	55	MA-22114-50	54
MA-134CPLG	59	MA-10346	35	MA-12356	3	MA-16513	6	MA-22006	55	MA-22114-100	54
MA-142A	29	MA-10347	35	MA-12357	3	MA-16529	15	MA-22006-25	55	MA-22116	54
MA-142-1	29	MA-10348	35	MA-12358	3	MA-16530	15	MA-22006-50	55	MA-22116-25	54
MA-142MA	29	MA-10349	35	MA-12535	57	MA-16531	9	MA-22006-100	55	MA-22116-50	54
MA-143A	29	MA-10350	35	MA-12537	57	MA-16532	9	MA-22007	55	MA-22116-100	54
MA-143M	29	MA-11069	11	MA-12545	57	MA-16533	8	MA-22007-25	55	MA-22117	54
MA-145D	25	MA-11302	32	MA-12547	57	MA-16540	9	MA-22007-50	55	MA-22117-25	54
MA-145EL	59	MA-11315	32	MA-12548	57	MA-16541	9	MA-22007-100	55	MA-22117-50	54
MA-147B	25	MA-11354	32	MA-12700	8	MA-16542	9	MA-22010	55	MA-22117-100	54
MA-147C	25	MA-11830	50	MA-12701	11	MA-16544	9	MA-22010-25	55	MA-22120	54
MA-149	29	MA-11840	50	MA-12702	11	MA-16551	7	MA-22010-50	55	MA-22120-25	54
MA-149-1	29	MA-11853	50	MA-12812	1	MA-17255	35	MA-22010-100	55	MA-22120-50	54
MA-157A	29	MA-11866	50	MA-12813	4	MA-17256	35	MA-22010	55	MA-22120-100	54
MA-157-1	29	MA-11879	50	MA-12814	3	MA-17257	35	MA-22010-25	55	MA-22122	54
MA-158A	29	MA-12004	55	MA-12815	11	MA-181834	34	MA-22010-50	55	MA-22122-25	54
MA-159A	29	MA-12004-25	55	MA-12816	3	MA-181838	34	MA-22010-100	55	MA-22122-50	54

PART #	PAGE	PART #	PAGE	PART #	PAGE	PART #	PAGE	PART #	PAGE	PART #	PAGE
MA-22122-100	54	MA-22286-50	54	MA-30311	58	MA-4E50A	87	MA-49091	51	MA-5406BX	56
MA-22151	54	MA-22286-100	54	MA-30357	58	MA-4E5090A	87	MA-49092	51	MA-5408BX	56
MA-22151-25	54	MA-22289	55	MA-30405	58	MA-4E51	89	MA-49116	19	MA-5410BX	56
MA-22151-50	54	MA-22289-25	55	MA-30407	58	MA-4E57	89	MA-49191	51	MA-5412BX	56
MA-22151-100	54	MA-22289-50	55	MA-30410	58	MA-4E58	89	MA-49192	51	MA-5416BX	56
MA-22152	54	MA-22289-100	55	MA-30457	58	MA-4E59A	87	MA-49193	51	MA-5420BX	56
MA-22152-25	54	MA-22290	55	MA-30605	58	MA-4E75	87	MA-49310	22	MA-5428BX	56
MA-22152-50	54	MA-22290-25	55	MA-30607	58	MA-4E7590	87	MA-49316	22	MA-5432BX	56
MA-22152-100	54	MA-22290-50	55	MA-30610	58	MA-4E79A	87	MA-49317	22	MA-56188	56
MA-22153	54	MA-22290-100	55	MA-30705	58	MA-4LC20D	87	MA-49318	22	MA-563211	37
MA-22153-25	54	MA-30F3	77	MA-30707	58	MA-4LC20E	87	MA-49320	27	MA-6LN	26
MA-22153-50	54	MA-30SA	81	MA-30710	58	MA-4LC43D	87	MA-49324	27	MA-61/4SA	81
MA-22153-100	54	MA-32N	32	MA-30818	57	MA-4LC43E	87	MA-49330	27	MA-60A	17
MA-22154	54	MA-32SA	81	MA-30821	57	MA-4LN	26	MA-49331	27	MA-60AFF	17
MA-22154-25	54	MA-34CAP	59	MA-30834	57	MA-4NMLT50	87	MA-49332	27	MA-60F3	77
MA-22154-50	54	MA-34CPLG	59	MA-30847	57	MA-4NMLT75	87	MA-49333	27	MA-60NF3	77
MA-22154-100	54	MA-34PLG	59	MA-31012	57	MA-4NMLT9050	87	MA-49334	27	MA-64N	32
MA-22157	54	MA-34RUEL	53	MA-31013	57	MA-4NMLT9075	87	MA-49858A	68	MA-600CF	4
MA-22157-25	54	MA-34T	59	MA-31014	57	MA-48L	30	MA-400RC30	37,38	MA-650B	71
MA-22157-50	54	MA-34U	59	MA-31015	57	MA-420G	26	MA-400RC50	37,38	MA-650N	71
MA-22157-100	54	MA-38RUEL	53	MA-31132	57	MA-422G	26	MA-401020	58	MA-651	43
MA-22159	54	MA-301	28	MA-31133	57	MA-424G	26	MA-401025	58	MA-6012W	77
MA-22159-25	54	MA-301RB	28	MA-31226	61	MA-426G	26	MA-406025	58	MA-6012WS	77
MA-22159-50	54	MA-302L	30	MA-31227	61	MA-430G	26	MA-407074	58	MA-6034W	77
MA-22159-100	54	MA-303	43	MA-31228	61	MA-440G	26	MA-409010	58	MA-6034WS	77
MA-22160	54	MA-311	43	MA-31229	61	MA-442G	26	MA-410005	58	MA-6182	90
MA-22160-25	54	MA-317G	26	MA-31230	61	MA-460G	26	MA-410007	58	MA-6183	90
MA-22160-50	54	MA-318	26	MA-31231	61	MA-4001	65	MA-410010	58	MA-6184	90
MA-22160-100	54	MA-322-2	49	MA-31318	58	MA-4010	36	MA-410101	58	MA-6185	90
MA-22161	54	MA-322-3	49	MA-31348	58	MA-4040	36	MA-417025	58	MA-6186	90
MA-22161-25	54	MA-326	26	MA-31405	58	MA-4012W	77	MA-429025	58	MA-6187	90
MA-22161-50	54	MA-337	26	MA-31407	58	MA-4012WS	77	MA-436074	58	MA-6188	90
MA-22161-100	54	MA-338	26	MA-31410	58	MA-4034W	77	MA-437131	58	MA-6192	90
MA-22182	54	MA-340-5	31	MA-32831	67	MA-4034WS	77	MA-437292	58	MA-6193	90
MA-22182-25	54	MA-345-1	31	MA-32832	67	MA-4101	66	MA-437339	58	MA-6194	90
MA-22182-50	54	MA-345-2	31	MA-32905	58	MA-4102	66	MA-447025	58	MA-6195	90
MA-22182-100	54	MA-348	26	MA-32907	58	MA-4103	66	MA-447040	58	MA-6196	90
MA-22185	54	MA-398	49	MA-32950	56	MA-4104	66	MA-448007	58	MA-6197	90
MA-22185-25	54	MA-398BL	49	MA-33350	30	MA-4401	66	MA-450007	58	MA-6198	90
MA-22185-50	54	MA-3412BG	59	MA-33570	30	MA-4402	66	MA-457005	58	MA-6202BX	56
MA-22185-100	54	MA-3412CPLG	59	MA-33905	58	MA-4403	66	MA-457007	58	MA-6203BX	56
MA-22186	54	MA-3445EL	59	MA-33907	58	MA-4404	66	MA-457010	58	MA-6204BX	56
MA-22186-25	54	MA-3466T	60	MA-33910	58	MA-4429	66	MA-457012	58	MA-6205BX	56
MA-22186-50	54	MA-3490EL	59	MA-34790	30	MA-4430	66	MA-457015	58	MA-6206BX	56
MA-22186-100	54	MA-3490STEL	59	MA-36732	30	MA-4431	66	MA-457020	58	MA-60609	27
MA-22187	54	MA-3600	75	MA-36742	30	MA-4432	66	MA-493114	22	MA-60610	27
MA-22187-25	54	MA-3612	75	MA-341212T	59	MA-4433	66	MA-5DIV	43	MA-60613	27
MA-22187-50	54	MA-30038	90	MA-343412T	59	MA-4540	66	MA-5DT1	63	MA-60613-25	27
MA-22187-100	54	MA-30050	90	MA-4E104A	89	MA-40038	90	MA-5DT112	63	MA-60616	27
MA-22192	54	MA-30075	90	MA-4E110	89	MA-40050	90	MA-5DT114	63	MA-60616-25	27
MA-22192-25	54	MA-30105	58	MA-4E121	88	MA-40075	90	MA-5GP	43	MA-60743	66
MA-22192-50	54	MA-30107	58	MA-4E122	88	MA-41300	30	MA-5TC	43	MA-60954	66
MA-22192-100	54	MA-30110	58	MA-4E123	88	MA-41500	52	MA-5TCA	43	MA-61623	66
MA-22263	54	MA-30132	32	MA-4E124	88	MA-43482	42	MA-50ABF	17	MA-61834	66
MA-22263-25	54	MA-30155	58	MA-4E1101	89	MA-43484	42	MA-51	46	MA-62044	66
MA-22263-50	54	MA-30157	58	MA-4E1102	89	MA-43486	42	MA-500AV	68	MA-63223	66
MA-22263-100	54	MA-30158	58	MA-4E21	88	MA-43488	42	MA-502N-8L	64	MA-63493	66
MA-22264	54	MA-30200	32	MA-4E22	88	MA-44003	51	MA-572A	52	MA-65093	66
MA-22264-25	54	MA-30275	58	MA-4E23	88	MA-45120	26	MA-5027	30	MA-67363	66
MA-22264-50	54	MA-30301	77	MA-4E24	88	MA-46810	43	MA-5400S	30	MA-68150	49
MA-22264-100	54	MA-30303	77	MA-4E421	89	MA-49051	36	MA-5400M	30	MA-69523	67
MA-22286	54	MA-30305	58	MA-4E422	89	MA-49052A	36	MA-5400L	30	MA-7CF	26
MA-22286-25	54	MA-30307	58	MA-4E48	89	MA-49090	51	MA-5400XL	30	MA-7WR	26

PART #	PAGE	PART #	PAGE	PART #	PAGE	PART #	PAGE	PART #	PAGE	PART #	PAGE
MA-70-14JR	33	MA-7658	83	MA-72066	25	MA-82012	70	MA-9633	24	MA-AGC-2	82
MA-71-132R	33	MA-7659	84	MA-72314	66	MA-82110	70	MA-9634	24	MA-AGC-2-1/2	82
MA-701L	30	MA-7660	84	MA-72433	32	MA-82111	70	MA-9635	24	MA-AGC-3	82
MA-7300	30	MA-7661	84	MA-72435	32	MA-82112	70	MA-9636	24	MA-AGC-4	82
MA-7321	68	MA-7662	84	MA-72437	32	MA-82113	70	MA-9637	24	MA-AGC-5	82
MA-7339	6	MA-7663	84	MA-72439	32	MA-82114	70	MA-9638	24	MA-AGC-6	82
MA-7409	12	MA-7664	84	MA-72744	66	MA-82115	70	MA-9639	24	MA-AGC-7	82
MA-7514	84	MA-7665	84	MA-72815	58	MA-82118	70	MA-9643	24	MA-AGC-8	82
MA-7515	84	MA-7667	84	MA-72820	58	MA-82211	70	MA-9644	24	MA-AGC-9	82
MA-7518	83	MA-7668	84	MA-72830	58	MA-84002	51	MA-9645	24	MA-AGC-10	82
MA-7519	82	MA-7669	84	MA-73093	66	MA-88057	22	MA-9646	24	MA-AGC-15	82
MA-7525	84	MA-7670	83	MA-73101	34	MA-88081	22	MA-9647	24	MA-AGC-25	82
MA-7599	84	MA-7671	83	MA-73102	34	MA-88091	22	MA-9648	24	MA-AGC-30	82
MA-7600	83	MA-7672	83	MA-73103	34	MA-9LN	26	MA-9649	24	MA-AH4295	31
MA-7601	83	MA-7673	83	MA-73104	34	MA-99	46	MA-9650	24	MA-AH5795	31
MA-7602	83	MA-7674	84	MA-73105	34	MA-908G	26	MA-9651	24	MA-AH8512	31
MA-7603	83	MA-70059P	22	MA-73106	34	MA-909	26	MA-9652	24	MA-AL2412W	51
MA-7604	83	MA-70090	27	MA-73107	34	MA-926	26	MA-9653	24	MA-AL2412M	51
MA-7605	83	MA-70091	27	MA-73108	34	MA-9001	32	MA-9654	24	MA-ALAA	65
MA-7606	83	MA-70093	27	MA-73109	34	MA-9002	32	MA-9655	24	MA-ALAAA	65
MA-7607	83	MA-70094	27	MA-73110	34	MA-9003	32	MA-9656	24	MA-ALC	65
MA-7608	83	MA-70095	27	MA-73111	34	MA-9306	22	MA-9657	24	MA-ALD	65
MA-7609	84	MA-70097	27	MA-73112	34	MA-9308	22	MA-9658	24	MA-AL9V	65
MA-7610	84	MA-70098	27	MA-73532	30	MA-9310	22	MA-9659	24	MA-AM2A026	65
MA-7611	83	MA-70099	27	MA-73815	58	MA-9311	22	MA-9660	24	MA-AM2A056	65
MA-7612	84	MA-70100	27	MA-73820	58	MA-9312	22	MA-9661	24	MA-AM3A026	65
MA-7613	84	MA-70115	58	MA-73830	58	MA-9314	22	MA-9662	24	MA-ARRLP	39
MA-7614	84	MA-70116	58	MA-74213	66	MA-9316	22	MA-9663	24	MA-ASXC046	65
MA-7615	84	MA-70120	58	MA-76110	31	MA-9355	22	MA-9664	24	MA-ASXD036	65
MA-7617	84	MA-70121	58	MA-77940	32	MA-9357	25	MA-9665	24	MA-AT12	35
MA-7618	84	MA-70122	58	MA-748325A	65	MA-9358	25	MA-90303	38	MA-AT14	35
MA-7621	83	MA-70130	58	MA-8R	26	MA-9601	24	MA-90304	38	MA-AT14-5	35
MA-7624	83	MA-70132	58	MA-806	26	MA-9602	24	MA-90502	38	MA-AT18	35
MA-7625	83	MA-70133	58	MA-808	26	MA-9603	24	MA-90503	38	MA-AT18-5	35
MA-7626	83	MA-70151	58	MA-810	26	MA-9604	24	MA-93482	42	MA-AT38	35
MA-7630	84	MA-70152	58	MA-812	26	MA-9605	24	MA-93484	42	MA-AT38-5	35
MA-7631	84	MA-70153	58	MA-8016	52	MA-9606	24	MA-93486	42	MA-AT58	35
MA-7632	84	MA-70204	66	MA-8032	52	MA-9607	24	MA-93488	42	MA-AT316	35
MA-7633	84	MA-70221	58	MA-8070	36	MA-9608	24	MA-96400	43	MA-AT316-5	35
MA-7634	84	MA-70231	58	MA-8101	66	MA-9609	24	MA-A038	46	MA-AT516	35
MA-7635	84	MA-70232	58	MA-8201	66	MA-9610	24	MA-A048	46	MA-AT716	35
MA-7636	84	MA-70250	33	MA-8202	66	MA-9611	24	MA-AA45E	33	MA-ATC2	82
MA-7637	84	MA-70251	33	MA-8203	66	MA-9612	24	MA-AA46V	33	MA-ATC3	82
MA-7638	84	MA-70252	33	MA-8204	66	MA-9613	24	MA-AA47R	33	MA-ATC4	82
MA-7639	84	MA-70253	33	MA-8205	66	MA-9614	24	MA-ABC-1	82	MA-ATC5	82
MA-7640	84	MA-70254	33	MA-8206	68	MA-9615	24	MA-ABC-2	82	MA-ATC7.5	82
MA-7641	84	MA-70255	33	MA-8207	64	MA-9616	24	MA-ABC-3	82	MA-ATC10	82
MA-7642	84	MA-70256	33	MA-8250	36	MA-9617	24	MA-ABC-5	82	MA-ATC15	82
MA-7643	84	MA-70257	33	MA-8400	29	MA-9618	24	MA-ABC-6	82	MA-ATC20	82
MA-7644	84	MA-70343	65	MA-8401	29	MA-9619	24	MA-ABC-8	82	MA-ATC25	82
MA-7645	84	MA-70474	66	MA-8408	29	MA-9620	24	MA-ABC-10	82	MA-ATC30	82
MA-7646	84	MA-70615	58	MA-8410	70	MA-9621	24	MA-ABC-12	82	MA-BC1	63
MA-7647	84	MA-70620	58	MA-8411	70	MA-9622	24	MA-ABC-15	82	MA-BC2	63
MA-7648	83	MA-70630	58	MA-8412	70	MA-9623	24	MA-ABC-20	82	MA-BC12	63
MA-7649	83	MA-71115	58	MA-8413	70	MA-9624	24	MA-ABC-30	82	MA-BC14	63
MA-7650	83	MA-71120	58	MA-8414	70	MA-9625	24	MA-AC14	51	MA-BC34	63
MA-7651	83	MA-71130	58	MA-8415	70	MA-9626	24	MA-AGC-1/32	82	MA-BC38	63
MA-7652	83	MA-71354	66	MA-8646M	30	MA-9627	24	MA-AGC-1/4	82	MA-BC112	63
MA-7653	83	MA-71493	65	MA-8646L	30	MA-9628	24	MA-AGC-1/2	82	MA-BC114	63
MA-7654	83	MA-71801P	33	MA-8646XL	30	MA-9629	24	MA-AGC-3/4	82	MA-BDHTR	16
MA-7655	83	MA-71802P	33	MA-82006	70	MA-9630	24	MA-AGC-1	82	MA-BDIOT	16
MA-7656	83	MA-71803P	33	MA-82010	70	MA-9631	24	MA-AGC-1-1/4	82	MA-BF1	50
MA-7657	83	MA-72023	66	MA-82011	70	MA-9632	24	MA-AGC-1-1/2	82	MA-BFC	50

PART #	PAGE	PART #	PAGE	PART #	PAGE	PART #	PAGE	PART #	PAGE	PART #	PAGE
MA-BI14	52	MA-BTGM	44	MA-CSSD54-12	34	MA-D323015	58	MA-E30	88	MA-E272	85
MA-BI6	52	MA-BTGO	44	MA-CSSD54-18	34	MA-D323020	58	MA-E37-1	88	MA-E273	85
MA-BN1CL	59	MA-BTGDB	44	MA-CSSD54-24	34	MA-D323030	58	MA-E37-2	88	MA-E27325	87
MA-BN12	59	MA-BTGDK	44	MA-CSSD54-36	34	MA-D400040	58	MA-E37-3	88	MA-E273-100	87
MA-BN1212	59	MA-BTGEK	44	MA-CSSD54-48	34	MA-DCM3	4	MA-E42-1	89	MA-E274	85
MA-BN13	59	MA-BTGKM	44	MA-CSSD54-60	34	MA-DE904	46	MA-E42-2	89	MA-E298-21	89
MA-BN1312	59	MA-BTGUM	44	MA-CSSD54-72	34	MA-DLSR10	80	MA-E42-3	89	MA-E298-31	89
MA-BN14	59	MA-BTGRK	44	MA-CT1	61	MA-DLSR15	80	MA-E42-4	89	MA-E298-32	89
MA-BN1412	59	MA-BTGUK2	44	MA-CVT1	53	MA-DLSR20	80	MA-E42-5	89	MA-E298-41	89
MA-BN15	59	MA-BTGUM2	44	MA-CVT12	53	MA-DLSR30	80	MA-E48	89	MA-E298-42	89
MA-BN1512	59	MA-BTGUWM	44	MA-CVT14	53	MA-DLSR35	80	MA-E50A	87	MA-E298-43	89
MA-BN16	59	MA-BTG54VL	44	MA-CVT316	53	MA-DLSR40	80	MA-E51	89	MA-E298-51	89
MA-BN12CL	59	MA-BTG54VLW	44	MA-CVT34	53	MA-DLSR45	80	MA-E52PL	89	MA-E298-52	89
MA-BN12112	59	MA-C2242	72	MA-CVT38	53	MA-DLSR50	80	MA-E57	89	MA-E298-53	89
MA-BN122	59	MA-C6408	72	MA-CVT58	53	MA-DLSR60	80	MA-E58	89	MA-E298-54	89
MA-BN12212	59	MA-C6433	72	MA-CVT78	53	MA-DLSR70	80	MA-E59	89	MA-E303	85
MA-BN123	59	MA-C6435G	72	MA-CW300	47	MA-DLSR80	80	MA-E60PL	89	MA-E303D	85
MA-BN12312	59	MA-C6435B	72	MA-CW301	47	MA-DLSR90	80	MA-E61PL	89	MA-E304EXT	85
MA-BN124	59	MA-C6435O	72	MA-CW401	47	MA-DLSR100	80	MA-E65PL	89	MA-E350EXT	85
MA-BN12412	59	MA-C6435R	72	MA-CW402	47	MA-DLSR125	80	MA-E69PL	89	MA-E352	85
MA-BN125	59	MA-C6435W	72	MA-CW406	47	MA-DLSR150	80	MA-E75	87	MA-E353	85
MA-BN12512	59	MA-C6435Y	72	MA-CW502	47	MA-DLSR200	80	MA-E80	89	MA-E353D	85
MA-BN126	59	MA-C6435GN	72	MA-CW503	47	MA-DM1	1	MA-E81	89	MA-E363D	85
MA-BN34CL	59	MA-C6435BR	72	MA-CW601	47	MA-DMTK1,2,4,5,6,13		MA-E82	89	MA-E374	85
MA-BN34112	59	MA-C6488	72	MA-CW650	47	MA-DMTL	1,3	MA-E83	89	MA-E374D	85
MA-BN342	59	MA-C950	57	MA-CW651	47	MA-DMTL1	1,2,4,5,11	MA-E96-1CG	89	MA-E376	89
MA-BN34212	59	MA-C950-4	57	MA-CW652	47	MA-DMTL3	8	MA-E96-2CG	89	MA-E377	89
MA-BN343	59	MA-CF1	62	MA-CW660	47	MA-DMTL4	3	MA-E96-3CG	89	MA-E378	89
MA-BN34312	59	MA-CF-50	62	MA-CW665	47	MA-DMTP	1	MA-E96-4CG	89	MA-E379	89
MA-BN344	59	MA-CF-100	62	MA-CW701	47	MA-DMT3	1	MA-E96-5CG	89	MA-E380	89
MA-BN34412	59	MA-CH100	37	MA-CW801	47	MA-DMT123	13	MA-E100	87	MA-E504	86
MA-BN345	59	MA-CH101	37	MA-CW802	47	MA-DP244	46	MA-E104A	89	MA-E508D	86
MA-BN34512	59	MA-CH101-1	37	MA-CCW353	47	MA-DS4	52	MA-E105	89	MA-E508T	86
MA-BN346	59	MA-CH101-2	37	MA-CCW404	47	MA-DS6	52	MA-E106	89	MA-E509	86
MA-BP112	59	MA-CH101-3	37	MA-CCW504	47	MA-DT1	63	MA-E107	89	MA-E554	86
MA-BP118	59	MA-CH102	37	MA-CCW505	47	MA-DT2	63	MA-E110	89	MA-E560	86
MA-BP124	59	MA-CH102-1	37	MA-CCW550	47	MA-DT12	63	MA-E110-1	89	MA-E564	86
MA-BP130	59	MA-CH102-2	37	MA-CCW604	47	MA-DT34	63	MA-E110-2	89	MA-E570	86
MA-BP136	59	MA-CH103	37	MA-CCW605	47	MA-DT112	63	MA-E110-3	89	MA-E571	86
MA-BP148	59	MA-CH103-2	37	MA-CCW606	47	MA-DT114	63	MA-E110-4	89	MA-E572	86
MA-BP160	59	MA-CH135	37	MA-CCW703	47	MA-EGL20	51	MA-E110-5	89	MA-E573	86
MA-BP1212	59	MA-CIMK2	52	MA-D115	79	MA-EGL24	51	MA-E128	88	MA-E574	86
MA-BP1218	59	MA-CL1	19	MA-D120	79	MA-E0PL	86	MA-E122	88	MA-E575	86
MA-BP1224	59	MA-CP1	56	MA-D130	79	MA-E1PL	86	MA-E123	88	MA-E584	85
MA-BP1230	59	MA-CP2	56	MA-D140	79	MA-E2PL	86	MA-E124	88	MA-E590	85
MA-BP1236	59	MA-CP35-120	56	MA-D150	79	MA-E2PL-1	87	MA-E125	88	MA-E594	85
MA-BP1248	59	MA-CP35-240	56	MA-D160	79	MA-E2PL25	87	MA-E126	88	MA-E900	89
MA-BP1260	59	MA-CP52-120	56	MA-D215	79	MA-E3PL	86	MA-E127	88	MA-E901	89
MA-BP3412	59	MA-CP52-240	56	MA-D220	79	MA-E3PL-1	87	MA-E128	88	MA-E902	89
MA-BP3418	59	MA-CSSC21-12	34	MA-D230	79	MA-E3PL25	87	MA-E129	88	MA-E903	89
MA-BP3424	59	MA-CSSC21-18	34	MA-D240	79	MA-E4PL	86	MA-E130	88	MA-E904	89
MA-BP3430	59	MA-CSSC21-24	34	MA-D250	79	MA-E5S	88	MA-E144-1	88	MA-E2390-2	88
MA-BP3436	59	MA-CSSC21-36	34	MA-D260	79	MA-E7S	88	MA-E144-2	88	MA-E5090A	87
MA-BP3448	59	MA-CSSC21-48	34	MA-D100040	58	MA-E10S	88	MA-E200	85	MA-E7590	87
MA-BP3460	59	MA-CSSC21-60	34	MA-D102420	58	MA-E21	88	MA-E200EXT	85	MA-E10090	87
MA-BT1	63	MA-CSSC21-72	34	MA-D102422	58	MA-E22	88	MA-E201	85	MA-E12590	87
MA-BT2	63	MA-CSSC54-12	34	MA-D130040	58	MA-E23	88	MA-E202	85	MA-E15090	87
MA-BT12	63	MA-CSSC54-18	34	MA-D300040	58	MA-E24	88	MA-E201-3/4	85	MA-EM3213A	6
MA-BT14	63	MA-CSSC54-24	34	MA-D304040	58	MA-E25	88	MA-E251	86	MA-EM3215	6
MA-BT34	63	MA-CSSC54-36	34	MA-D309015	58	MA-E26	88	MA-E252	86	MA-EXT4	49
MA-BT38	63	MA-CSSC54-48	34	MA-D309020	58	MA-E27	88	MA-E253	86	MA-F336	44
MA-BT112	63	MA-CSSC54-60	34	MA-D309030	58	MA-E28	88	MA-E254	86	MA-FA134	43
MA-BT114	63	MA-CSSC54-72	34	MA-D321040	58	MA-E29	88	MA-E255	86	MA-FB2	23

PART #	PAGE	PART #	PAGE	PART #	PAGE	PART #	PAGE	PART #	PAGE	PART #	PAGE
MA-FD30A	77	MA-FRSR6.25	80	MA-HS4W	46	MA-MC43C	90	MA-NS2	23	MA-PH50	62
MA-FD60A	77	MA-FRSR8	80	MA-HS50	36	MA-MC123	13	MA-NS12	23	MA-PH100	62
MA-FL13089	64	MA-FRSR10	80	MA-HSB4B	46	MA-MC450	46	MA-NS14	23	MA-PS120	15
MA-FL24LEDA	64	MA-FRSR12	80	MA-HSB4W	46	MA-MDL-1/4	82	MA-NS16	23	MA-PS220	15
MA-FL32LED	64	MA-FRSR15	80	MA-HT1	50	MA-MDL-1/2	82	MA-NS18	23	MA-PT14	53
MA-FL28L	64	MA-FRSR20	80	MA-HT64	50	MA-MDL-3/4	82	MA-NS22	23	MA-PT38	53
MA-FLS0325	46	MA-FRSR25	80	MA-HTSS-R	60	MA-MDL-1	82	MA-NS24	23	MA-PT70C	14
MA-FLS0425	46	MA-FRSR30	80	MA-HU1	51	MA-MDL-1-1/4	82	MA-NS26	23	MA-PT110C	14
MA-FLS0450	46	MA-FRSR35	80	MA-HWA02	63	MA-MDL-2	82	MA-NS28	23	MA-PT160	14
MA-FM50	48	MA-FRSR40	80	MA-HWA05	63	MA-MDL-2-1/2	82	MA-NS32	23	MA-PT160B	14
MA-FM55	48	MA-FRSR45	80	MA-HWG02	63	MA-MDL-3	82	MA-NS36	23	MA-PT220	14
MA-FNM10	82	MA-FRSR50	80	MA-HWG05	63	MA-MDL-3.2	82	MA-NS40	23	MA-PT220B	14
MA-FNM12	82	MA-FRSR60	80	MA-IC13	67	MA-MDL-4	82	MA-NS1000	23	MA-PT550	14
MA-FNM15	82	MA-FRSR70	80	MA-IC15	67	MA-MDL-5	82	MA-NS2000	23	MA-PT134160	14
MA-FNM20	82	MA-FRSR80	80	MA-IMK1	52	MA-MDL-6	82	MA-NSPD1	23	MA-PT134220	14
MA-FNM25	82	MA-FRSR90	80	MA-IRT203B	7	MA-MDL-7	82	MA-NW14	63	MA-PT138160	14
MA-FNM30	82	MA-FRSR100	80	MA-J100	56	MA-MDL-8	82	MA-NW16	63	MA-PT138220	14
MA-FNM35	82	MA-FRSR110	80	MA-J1500	62	MA-MDL-10	82	MA-NW18	63	MA-PVC27	57
MA-FNM40	82	MA-FRSR125	80	MA-J2000	62	MA-MDL-15	82	MA-NW110	63	MA-PVC42	57
MA-FNQ10	82	MA-FRSR150	80	MA-J3000	62	MA-MDL-20	82	MA-NW124	63	MA-Q115	79
MA-FNQ12	82	MA-FRSR175	80	MA-J4000	62	MA-MDL-25	82	MA-NW126	63	MA-Q120	79
MA-FNQ15	82	MA-FRSR200	80	MA-K1	63	MA-MDL-30	82	MA-NW128	63	MA-Q125	79
MA-FNQ20	82	MA-FRSR225	80	MA-K2	63	MA-MFC1	23	MA-NW344	63	MA-Q130	79
MA-FNQ25	82	MA-FT1	61	MA-K3	63	MA-MFC2	23	MA-NW346	63	MA-Q140	79
MA-FNQ30	82	MA-GF1	62	MA-K12	63	MA-MFC3	23	MA-NW348	63	MA-Q150	79
MA-FRNR1	80	MA-GF-50	62	MA-K34	63	MA-MGT1	75	MA-NW1126	63	MA-Q160	79
MA-FRNR1.25	80	MA-GF-100	62	MA-K114	63	MA-MGT2	75	MA-NW1128	63	MA-Q215	79
MA-FRNR1.6	80	MA-GH25	52	MA-K112	63	MA-MMD3E	12	MA-NW1146	63	MA-Q220	79
MA-FRNR2	80	MA-GH50	52	MA-K212	63	MA-MSC4100	46	MA-NW1148	63	MA-Q225	79
MA-FRNR2.5	80	MA-GL10	26	MA-KNB25	63	MA-MT53	27	MA-NW1210	63	MA-Q230	79
MA-FRNR3.2	80	MA-HACR3.2	80	MA-KNB50	63	MA-MT62	27	MA-NW3410	63	MA-Q240	79
MA-FRNR4	80	MA-HACR5	80	MA-K3A016	64	MA-N12	49	MA-NW11410	63	MA-Q250	79
MA-FRNR5	80	MA-HACR6.25	80	MA-KC709	28	MA-N14	49	MA-NW14-C	63	MA-Q260	79
MA-FRR6.25	80	MA-HACR10	80	MA-KC710	28	MA-N38	49	MA-NW16-C	63	MA-Q270	79
MA-FRNR8	80	MA-HACR15	80	MA-KN73	28	MA-N516	49	MA-NW18-C	63	MA-Q280	79
MA-FRNR10	80	MA-HACR20	80	MA-KN74HD	28	MA-NAT18-5	35	MA-NW124-C	63	MA-Q290	79
MA-FRNR12	80	MA-HACR25	80	MA-KTS	28	MA-NAT316	35	MA-NW126-C	63	MA-Q2100	79
MA-FRNR15	80	MA-HACR30	80	MA-KVS007	28	MA-NAT316-5	35	MA-NW128-C	63	MA-Q2125	79
MA-FRNR20	80	MA-HACR35	80	MA-KVS008	28	MA-NFD60A	77	MA-NW344-C	63	MA-QP400	22,26
MA-FRNR25	80	MA-HACR40	80	MA-L1057	64	MA-NG2000-A	12	MA-NW346-C	63	MA-QP400-12	22
MA-FRNR30	80	MA-HACR45	80	MA-LK3A001	65	MA-NMLT50	87	MA-NW348-C	63	MA-QP400-G	22
MA-FRNR35	80	MA-HACR50	80	MA-LM2A001	65	MA-NMLT75	87	MA-NW1126-C	63	MA-QT1515	79
MA-FRNR40	80	MA-HACR60	80	MA-LM3A001	65	MA-NMLT9050	87	MA-NW1128-C	63	MA-QT1520	79
MA-FRNR45	80	MA-HACR70	80	MA-L42	57	MA-NMLT9075	87	MA-NW1146-C	63	MA-QT2020	79
MA-FRNR50	80	MA-HACR80	80	MA-L42RB	57	MA-NON1	81	MA-NW1148-C	63	MA-QT2030	79
MA-FRNR60	80	MA-HACR100	80	MA-L50	57	MA-NON3	81	MA-OVN1	16	MA-QT3030	79
MA-FRNR70	80	MA-HACR125	80	MA-L50RB	57	MA-NON6	81	MA-P4012W	77	MA-REF401F	36
MA-FRNR80	80	MA-HACR200	80	MA-LC20D	87	MA-NON10	81	MA-P4012WS	77	MA-REF401C	36
MA-FRNR90	80	MA-HC-4	53	MA-LC20E	87	MA-NON15	81	MA-P6012W	77	MA-REF700	36
MA-FRNR100	80	MA-HDT14	53	MA-LC43D	87	MA-NON20	81	MA-P6012WS	77	MA-RS300	31
MA-FRNR110	80	MA-HDT38	53	MA-LC43E	87	MA-NON25	81	MA-P4034W	77	MA-RT1	16
MA-FRNR125	80	MA-HDT12	53	MA-LS4	7	MA-NON30	81	MA-P4034WS	77	MA-RT330	14
MA-FRNR150	80	MA-HDT58	53	MA-LT125	87	MA-NON35	81	MA-P6034W	77	MA-RT335	14
MA-FRNR175	80	MA-HDT316	53	MA-LT150	87	MA-NON40	81	MA-P6034WS	77	MA-RT340	14
MA-FRNR200	80	MA-HDT34	53	MA-LWSA201	65	MA-NON45	81	MA-PAK-1	71	MA-RT340LS	14
MA-FRNR225	80	MA-HDT78	53	MA-LWSA301	65	MA-NON50	81	MA-PAK-2	71	MA-RT343	13
MA-FRSR1	80	MA-HDT1	53	MA-LWSA401	65	MA-NON60	81	MA-PAK-3	71	MA-RT818	14
MA-FRSR1.25	80	MA-HML7	64	MA-LWSA501	65	MA-NON70	81	MA-PDT392B	14	MA-RT819	15
MA-FRSR1.6	80	MA-HP3	49	MA-M2A016	64	MA-NON80	81	MA-PFD30A	77	MA-RT8101	17
MA-FRSR2	80	MA-HP6	49	MA-M2A01H	64	MA-NON100	81	MA-PFD60A	77	MA-RT900	13
MA-FRSR2.5	80	MA-HP3-2P	49	MA-M3A016	64	MA-NON150	81	MA-PNFD60A	77	MA-RT901	13
MA-FRSR3.2	80	MA-HP6-2P	49	MA-MC22C	90	MA-NON175	81	MA-PG1	47	MA-RT900P	13
MA-FRSR4	80	MA-HRFT1	16	MA-MC23C	90	MA-NON200	81	MA-PG316	61	MA-RT901P	13
MA-FRSR5	80	MA-HS4B	46	MA-MC42C	90	MA-NS1	23	MA-PG38	61	MA-RVHAW4	46

PART #	PAGE	PART #	PAGE	PART #	PAGE	PART #	PAGE	PART #	PAGE	PART #	PAGE
MA-RVHAB4	46	MA-SHCFC123-5039		MA-SRECT	39	MA-THHNS-10B	76	MA-UBGGB	46	MA00151-1	72
MA-RVHUW4	46	MA-SHKN73	28	MA-SRECT-50	39	MA-THHNS-10R	76	MA-V1	19	MA00152-1	72
MA-RVHUB4	46	MA-SL15A	81	MA-SRT18-5	35	MA-THHNS-10W	76	MA-V2	19	MA00153-1	72
MA-RX1019	63	MA-SL20A	81	MA-SRT316-5	35	MA-THHNS-10G	76	MA-VID-1	Inside Front Cover	MA00154-1	72
MA-S30	31	MA-SL25A	81	MA-SRT14-5	35	MA-THHNS-12B	76	MA-VID-2	Inside Front Cover	MA00478-1	90
MA-S3003	12	MA-SL30A	81	MA-SSA-CK	60	MA-THHNS-12R	76	MA-VIMK2	52	MA00479-1	90
MA-S1A	81	MA-SLG1	61	MA-SSB-CK	60	MA-THHNS-12W	76	MA-VIMK3	52	MA00480-1	90
MA-S11/4A	81	MA-SLG2	61	MA-SSC-CK	60	MA-THHNS-12G	76	MA-VIMK4	52	MA01018-1	69
MA-S16A	81	MA-SM6	29	MA-SSG-CK	60	MA-THHNS-14B	76	MA-W12	49	MA01019-1	69
MA-S2A	81	MA-SM7	29	MA-SSW-CK	60	MA-THHNS-14R	76	MA-W14	49	MA01020-1	69
MA-S21/2A	81	MA-SM8	29	MA-SRU	68,81	MA-THHNS-14W	76	MA-W3A	81	MA01021-1	69
MA-S2C016	64	MA-SMO1	39	MA-SRY	68,81	MA-THHNS-14G	76	MA-W38	49	MA01022-1	69
MA-S2D016	64	MA-SMO1-50	39	MA-SSU	68,81	MA-TL15A	81	MA-W455	52	MA01018-2	69
MA-S3C016	64	MA-SN5795	31	MA-SSW	68,81	MA-TL20A	81	MA-W5A	81	MA01019-2	69
MA-S3D016	64	MA-SN8512	31	MA-SSX	68,81	MA-TL25A	81	MA-W516	49	MA01020-2	69
MA-S32A	81	MA-SN8514	31	MA-SSY	68,81	MA-TL30A	81	MA-W6A	81	MA01021-2	69
MA-S4A	81	MA-SNAT316-5	35	MA-SSS100	60	MA-TN5044	55	MA-W8A	81	MA01022-2	69
MA-S4C016	64	MA-SOPK	3	MA-ST200	16	MA-TN5044-25	55	MA-W10A	81	MA01018-3	69
MA-S4D016	64	MA-SPA1	39	MA-STS	28	MA-TN5044-50	55	MA-WHP22	56	MA01019-3	69
MA-S5A	81	MA-SPA1-50	39	MA-SUT45	16	MA-TN5044-100	55	MA-WHP24	56	MA01020-3	69
MA-S5D016	64	MA-SPARLP	39	MA-SVHAW4	46	MA-TN5066	55	MA-WHP26	56	MA01021-3	69
MA-S6A	81	MA-SPO1	39	MA-SVHAB4	46	MA-TN5066-25	55	MA-WHP28	56	MA01022-3	69
MA-S61/4A	81	MA-SP01-50	39	MA-SVHUW4	46	MA-TN5066-50	55	MA-WHP32	56	MA01018P	69
MA-S60	31	MA-SR11	39	MA-SVHUB4	46	MA-TN5066-100	55	MA-WL72LED	64	MA01019P	69
MA-S8A	81	MA-SR11-50	39	MA-SW70C-6	30	MA-TN5088	55	MA-WP1	56	MA01020P	69
MA-S10A	81	MA-SR12	39	MA-T1005	60	MA-TN5088-25	55	MA-WTJ1	71	MA01021P	69
MA-S12A	81	MA-SR12-50	39	MA-T1007	60	MA-TN5088-50	55	MA-WU17	51	MA01022P	69
MA-S14	53	MA-SR22	39	MA-T1010	60	MA-TN5088-100	55	MA-WU21	51	MA01018BX	69
MA-S15A	81	MA-SR22-50	39	MA-T1057	60	MA-TN51212	55	MA-XL80-4	30	MA01019BX	69
MA-S20A	81	MA-SR113	39	MA-T1A	81	MA-TN51212-25	55	MA-XL80-25	30	MA01020BX	69
MA-S20T	33	MA-SR113-50	39	MA-T11/4A	81	MA-TN51212-50	55	MA-XP5	77	MA01021BX	69
MA-S25A	81	MA-SR114	39	MA-T16A	81	MA-TN51212-100	55	MA-XP6	77	MA01022BX	69
MA-S25	57	MA-SR114-50	39	MA-T2A	81	MA-TPB-1	43	MA-XP8	77	MA01023-1	74
MA-S25RB	57	MA-SR134A	39	MA-T21/2A	81	MA-TPT-1	43	MA0512G	76	MA01023-2	74
MA-S31A	81	MA-SR134A-50	39	MA-T32A	81	MA-TR12	49	MA0512P	76	MA01029-1	74
MA-S38	53	MA-SR401A	39	MA-T4A	81	MA-TR14	49	MA0514G	76	MA01029-2	74
MA-S144	31	MA-SR401A-50	39	MA-T5A	81	MA-TR38	49	MA0514P	76	MA01042-1	74
MA-SAB1	39	MA-SR401B	39	MA-T61/4A	81	MA-TR516	49	MA01012G	76	MA01042-2	74
MA-SAB1-50	39	MA-SR401B-50	39	MA-T7A	81	MA-TX100	78	MA01012P	76	MA01043-1	74
MA-SARLP	39	MA-SR402A	39	MA-T8A	81	MA-TX202	78	MA01014G	76	MA01043-2	74
MA-SC10	82	MA-SR402A-50	39	MA-T10A	81	MA-TX205	78	MA01014P	76	MA01046-1	74
MA-SC15	82	MA-SR402B	39	MA-T12A	81	MA-TX402	78	MA02512G	76	MA01046-2	74
MA-SC20	82	MA-SR402B-50	39	MA-T15A	81	MA-TX403	78	MA02512P	76	MA01066-1	68
MA-SC25	82	MA-SR404A	39	MA-T20A	81	MA-TX404	78	MA02514G	76	MA01123-1	74
MA-SC30	82	MA-SR404A-50	39	MA-T25A	81	MA-TX405	78	MA02514P	76	MA01128-1	73
MA-SC35	82	MA-SR406A	39	MA-T30A	81	MA-TX406	78	MA05012G	76	MA01130-1	74
MA-SC40	82	MA-SR406A-50	39	MA-TC123	6	MA-TX407	78	MA05012P	76	MA01130-2	74
MA-SC45	82	MA-SR407C	39	MA-THHN8B	76	MA-TX482	78	MA05014G	76	MA01143-1	74
MA-SC50	82	MA-SR407C-50	39	MA-THHN8R	76	MA-TX501	78	MA05014P	76	MA01143-2	74
MA-SC60	82	MA-SR408A	39	MA-THHN8W	76	MA-TX502	78	MA00014-1	68,82	MA01146-1	74
MA-SC150CF	61	MA-SR408A-50	39	MA-THHN8G	76	MA-TX775	78	MA00030-1	68,82	MA01146-2	74
MA-SC600CF	61	MA-SR409A	39	MA-THHN10B	76	MA-TX779	78	MA00036-1	72	MA01164-1	69
MA-SC1200CF	61	MA-SR409A-50	39	MA-THHN10R	76	MA-UR11	39	MA00098-1	72	MA01164C-2	69
MA-SC5000CF	61	MA-SR410A	39	MA-THHN10W	76	MA-UR12	39	MA00099-1	72	MA01165-1	69
MA-SDF1	39	MA-SR410A-50	39	MA-THHN10G	76	MA-UR22	39	MA00100-1	72	MA01165C-2	69
MA-SDB2	25	MA-SR417A	39	MA-THHN12B	76	MA-UR500	39	MA00101-1	72	MA01166-1	69
MA-SDB8	25	MA-SR417A-50	39	MA-THHN12R	76	MA-UR502	39	MA00102-1	72	MA01166C-2	69
MA-SH1500	62	MA-SR500	39	MA-THHN12W	76	MA-UR11-35	39	MA0126-12	33	MA02012-1	75
MA-SH2000	62	MA-SR500-50	39	MA-THHN12G	76	MA-UR12-35	39	MA0127-16	33	MA02013-1	74,75
MA-SH3000	62	MA-SR502	39	MA-THHN14B	76	MA-UR22-35	39	MA0128-25	33	MA02014-1	73,75
MA-SH4000	62	MA-SR502-50	39	MA-THHN14R	76	MA-UR500-35	39	MA0129-30	33	MA02015-1	75
MA-SH73	28	MA-SR507	39	MA-THHN14W	76	MA-UR502-35	39	MA0130-50	33	MA02043-1	71
MA-SHCFC123	39	MA-SR507-50	39	MA-THHN14G	76	MA-UBGWB	46	MA0131-100	33	MA02044-1	71

PART #	PAGE	PART #	PAGE	PART #	PAGE	PART #	PAGE	PART #	PAGE	PART #	PAGE
MA02045-1	71	MA02652-2	75	MA02907-2	74	MA03150-2	72	MA03219-2	76	MA03389-1	90
MA02046-1	71	MA02653-2	75	MA02911-2	74	MA03151-1	72	MA03219-3	76	MA03391-1	90
MA02065-1	73	MA02707-2	73	MA02933-1	67	MA03151-2	72	MA03220-2	76	MA03393-1	90
MA02065-2	73	MA02724-2	73	MA02936-1	67	MA03152-1	72	MA03220-3	76	MA03394-1	90
MA02066-1	73	MA02726-1	73	MA02939-2	73	MA03152-2	72	MA03221-2	76	MA03395-1	74
MA02066-2	73	MA02727-2	73	MA02940-2	73	MA03153-1	72	MA03221-3	76	MA03395-2	74
MA02109-1	74	MA02729-1	73	MA02942-2	73	MA03153-2	72	MA03222-2	76	MA03413-2	62
MA021120-2	71	MA02729-2	73	MA02944-2	73	MA03154-1	72	MA03222-3	76	MA03413-4	62
MA021120-2B	71	MA02744-1	73	MA02951-2	73	MA03154-2	72	MA03223-2	76	MA03414-2	62
MA02127-1	73	MA02745-2	73	MA02952-2	73	MA03155-1	72	MA03223-3	76	MA03414-4	62
MA02127-2	73	MA02746-1	73	MA02955-2	73	MA03155-2	72	MA03224-2	76	MA03415-2	62
MA02142-1	73	MA02747-2	73	MA02956-1	73	MA03156-1	72	MA03224-3	76	MA03415-4	62
MA02142-2	73	MA02749-1	73	MA02960-1	73	MA03156-2	72	MA03225-2	76	MA03416-2	62
MA02148-2	68	MA02762-2	73	MA02962-2	73	MA03157-1	72	MA03225-3	76	MA03416-4	62
MA02149-2	68	MA02770-1	73	MA02968-1	73	MA03157-2	72	MA03226-2	76	MA03417-2	62
MA02150-2	68	MA02771-2	73	MA02968-2	73	MA03158-1	72	MA03226-3	76	MA03417-4	62
MA02151-2	68	MA02773-1	73	MA02969-1	73	MA03158-2	72	MA03227-2	76	MA03465-1	74
MA02152-2	68	MA02774-2	73	MA02969-2	73	MA03159-1	72	MA03227-3	76	MA03466-1	74
MA02153-2	68	MA02776-1	73	MA02971-2	74	MA03159-2	72	MA03228-2	76	MA03467-1	74
MA02521-1	73	MA02777-2	73	MA02973-1	74	MA03161-1	72	MA03228-3	76	MA03467-2	74
MA02522-1	73	MA02779-1	73	MA02974-2	74	MA03161-2	72	MA03229-2	76	MA03469-1	74
MA02525-2	37	MA02780-2	73	MA02975-2	74	MA03162-1	72	MA03229-3	76	MA03469-2	74
MA02525-3	37	MA02782-1	73	MA02977-2	74	MA03162-2	72	MA03230-2	76	MA03471-1	74
MA02525-EUKIT	37	MA02783-2	73	MA02978-2	74	MA03163-1	72	MA03230-3	76	MA03471-2	74
MA02526-1	74	MA02785-1	73	MA02980-1	74	MA03163-2	72	MA03231-2	76	MA03473-1	74
MA02528-1	73	MA02786-2	73	MA02982-2	74	MA03164-1	72	MA03231-3	76	MA03473-2	74
MA02530-1	73	MA02816-1	73	MA02983-2	74	MA03164-2	72	MA03232-2	76	MA03475-1	74
MA02532-1	73	MA02818-1	73	MA02984-2	67	MA03165-1	72	MA03232-3	76	MA03475-2	74
MA02534-1	73	MA02820-1	73	MA02984-3	67	MA03165-2	72	MA03233-2	76	MA03477-1	74
MA02536-1	73	MA02821-1	73	MA02985-2	67	MA03166-1	72	MA03233-3	76	MA03477-2	74
MA02537-1	73	MA02822-2	73	MA02985-3	67	MA03166-2	72	MA03234-2	76	MA03500-2	25
MA02541-1	74	MA02823-1	73	MA02987-2	67	MA03167-1	72	MA03234-3	76	MA03505-2	25
MA02543-1	74	MA02824-2	73	MA02991-3	67	MA03167-2	72	MA03235-2	76	MA03506-2	25
MA02544-1	74	MA02825-1	73	MA03011-2	73	MA03168-1	72	MA03235-3	76	MA03507-2	25
MA02547-1	74	MA02826-2	73	MA03012-2	73	MA03168-2	72	MA03236-2	76	MA03508-2	25
MA02548-1	69	MA02827-1	73	MA03013-2	74	MA03169-1	72	MA03236-3	76	MA03509-2	25
MA02549-1	69	MA02828-2	73	MA03015-1	74	MA03169-2	72	MA03237-2	76	MA03510-2	25
MA02551-1	69	MA02830-1	73	MA03016-2	74	MA03171-1	71	MA03237-3	76	MA03539-2	24
MA02577-1	73	MA02833-1	73	MA03018-1	74	MA03172-2	71	MA03238-2	76	MA03539-24	24
MA02578-1	73	MA02834-2	73	MA03019-2	74	MA03174-1	71	MA03238-3	76	MA03540-2	24
MA02579-1	73	MA02837-2	73	MA03022-2	74	MA03175-2	71	MA03239-2	76	MA03540-24	24
MA02580-1	73	MA02839-1	73	MA03023-2	74	MA03177-1	71	MA03239-3	76	MA03541-2	24
MA02581-1	73	MA02840-2	73	MA03028-1	74	MA03178-2	71	MA03240-2	76	MA03541-24	24
MA02583-1	74	MA02842-1	73	MA03029-2	74	MA03180-1	71	MA03240-3	76	MA03542-2	24
MA02584-1	74	MA02843-2	73	MA03033-2	69	MA03181-2	71	MA03241-2	76	MA03543-2	24
MA02585-1	74	MA02860-1	73	MA03034-2	69	MA03183-1	71	MA03241-3	76	MA03544-2	24
MA02586-1	74	MA02861-2	73	MA03035-2	69	MA03184-2	71	MA03343-1	74	MA03545-2	24
MA02587-1	74	MA02869-1	73	MA03042-1	74	MA03185-1	71	MA03344-2	74	MA03546-2	24
MA02588-1	74	MA02870-2	73	MA03063-1	68	MA03188-2	71	MA03344-3	74	MA03565-2	62
MA02589-1	74	MA02872-1	73	MA03073-2	69	MA03189-1	71	MA03349-1	74	MA03565-3	62
MA02590-1	74	MA02873-2	73	MA03075-1	69	MA03190-2	71	MA03353-2	75	MA03566-2	62
MA02591-1	73	MA02875-1	73	MA03076-2	69	MA03192-1	71	MA03355-2	75	MA03566-4	62
MA02592-1	74	MA02876-2	73	MA03077-1	69	MA03193-2	71	MA03360-1	74	MA03567-2	62
MA02595-1	74	MA02881-1	73	MA03078-1	69	MA03195-1	71	MA03361-2	74	MA03567-3	62
MA02596-2	73	MA02882-2	73	MA03079-2	69	MA03196-2	71	MA03362-1	73	MA036175-2	71
MA02597-2	74	MA02894-1	74	MA03080-1	69	MA03198-1	71	MA03363-2	73	MA036175-2B	71
MA02598-2	74	MA02894-2	74	MA03090-1	67	MA03199-2	71	MA03364-2	72	MA03750-2	70
MA02618-2	74	MA02896-1	74	MA03092-1	67	MA03200-2	26	MA03373-2	69	MA03751-2	69,70
MA02619-2	74	MA02896-2	74	MA03093-1	67	MA03203-3	26	MA03375-2	75	MA03752-2	70
MA02620-2	73	MA02898-2	74	MA03096-2	67	MA03217-2	76	MA03376-2	75	MA03754-2	70
MA02621-2	73	MA02903-1	74	MA03149-1	72	MA03217-3	76	MA03383-1	90	MA03756-2	70
MA02622-2	73	MA02904-2	74	MA03149-2	72	MA03218-2	76	MA03385-1	90	MA03757-2	70
MA02623-2	73	MA02906-1	74	MA03150-1	72	MA03218-3	76	MA03387-1	90	MA03758-1	62

PART #	PAGE	PART #	PAGE	PART #	PAGE	PART #	PAGE	PART #	PAGE	PART #	PAGE
MA03758-2	62	MA048175-2B	71	MA10604-2	69	MA4L480	47	MA5L630	47	MASF-235	91
MA03758-3	62	MA05007-2	72	MA10604BX	69	MA4L490	47	MA5L640	47	MASF-305	91
MA03759-1	62	MA05008-2	72	MA10606-1	69	MA4L500	47	MA5L650	47	MASF105-P	91
MA03759-2	62	MA05031-2	67	MA10606-2	69	MA4L510	47	MA5L660	47	MASF-135-P	91
MA03759-3	62	MA06295-2	69,70	MA10606BX	69	MA4L520	47	MA5L670	47	MASF-175-P	91
MA03760-1	62	MA06295P	69	MA10608-1	69	MA4L530	47	MA5L680	47	MASF-235-P	91
MA03760-2	62	MA07172-2	71	MA10608-2	69	MA4L540	47	MA5L690	47	MASF-305-P	91
MA03760-3	62	MA07178-2	71	MA10608BX	69	MA4L550	47	MA5L700	47	MATM-100	92
MA03761-1	62	MA07181-2	71	MA10610P	69	MA4L560	47	MA5L710	47	MATM-135	92
MA03761-2	62	MA07182-2	71	MA3L310	47	MA4L570	47	MA5L720	47	MATM-180	92
MA03761-3	62	MA09353-2	24	MA3L320	47	MA4L580	47	MALS-55	91	MATM-250	92
MA03762-1	62	MA09354-2	24	MA3L330	47	MA4L590	47	MALS-105	91	MATM-100-P	92
MA03762-2	62	MAOHT12R1	76	MA3L340	47	MA4L600	47	MALS-135	91	MATM-135-P	92
MA03762-3	62	MAOHT12B1	76	MA3L350	47	MA4L610	47	MALS-180	91	MATM-180-P	92
MA03763-1	62	MAOHT12W1	76	MA3L360	47	MA4L620	47	MALS-240	91	MATM-250-P	92
MA03763-2	62	MAOHT12R2	76	MA3L370	47	MA4L630	47	MALS-310	91	QO115	79
MA03763-3	62	MAOHT12B2	76	MA3L380	47	MA4L640	47	MALS-400	91	QO120	79
MA03765-1	71	MAOHT12W2	76	MA3L390	47	MA4L650	47	MALS-55-P	91	QO130	79
MA03771-1	73	MAOHT12R3	76	MA3L400	47	MA4L660	47	MALS-105-P	91	QO140	79
MA03772-1	73	MAOHT12B3	76	MA3L410	47	MA4L670	47	MALS-135-P	91	QO150	79
MA03773-1	73	MAOHT12W3	76	MA3L420	47	MA4L680	47	MALS-180-P	91	QO160	79
MA03774-1	73	MAOHT12R4	76	MA3L430	47	MA4L690	47	MALS-50E1	91	QO215	79
MA03775-1	74	MAOHT12B4	76	MA3L440	47	MA4L700	47	MALS-95E1	91	QO220	79
MA03775-2	74	MAOHT12W4	76	MA3L450	47	MA4L710	47	MALS-125E1	91	QO230	79
MA03776-1	73	MAOHT12R5	76	MA3L460	47	MA4L720	47	MALS-160E1	91	QO240	79
MA03778-2	73	MAOHT12B5	76	MA3L470	47	MA5L300	47	MALS-210E1	91	QO250	79
MA03779-2	73	MAOHT12W5	76	MA3L480	47	MA5L310	47	MALS-210E2	91	QO260	79
MA03780-2	73	MAOHT14R1	76	MA4L170	47	MA5L320	47	MALS-280E1	91	T 002	38
MA03781-2	73	MAOHT14B1	76	MA4L180	47	MA5L330	47	MALS-280E2	91	T 003	38
MA03782-2	73	MAOHT14W1	76	MA4L190	47	MA5L340	47	MALS-360E2	91	T 005	38
MA03783-2	73	MAOHT14R2	76	MA4L200	47	MA5L350	47	MALS-540E2	91	T 018	38
MA03784-1	73	MAOHT14B2	76	MA4L210	47	MA5L360	47	MAMJ-40	92	T 019	38
MA03784-2	73	MAOHT14W2	76	MA4L220	47	MA5L370	47	MAMJ-70	92	T 027	38
MA03785-1	73	MAOHT14R3	76	MA4L230	47	MA5L380	47	MAMJ-90	92	T 032	38
MA03785-2	73	MAOHT14B3	76	MA4L240	47	MA5L390	47	MAMJ-120	92	T 076	38
MA03790-2	73	MAOHT14W3	76	MA4L250	47	MA5L400	47	MAMJ-40-P	92	T 080	38
MA03791-2	73	MAOHT14R4	76	MA4L260	47	MA5L410	47	MAMJ-70-P	92	T 085	38
MA03792-2	73	MAOHT14B4	76	MA4L270	47	MA5L420	47	MAMJ-90-P	92	T 0210	38
MA03793-2	73	MAOHT14W4	76	MA4L280	47	MA5L430	47	MAMJ-120-P	92	T 0220	38
MA03794-2	73	MAOHT14R5	76	MA4L290	47	MA5L440	47	MAPLP-380	92	T 0230	38
MA03798-1	73	MAOHT14B5	76	MA4L300	47	MA5L450	47	MAPLP-500	92	T 0240	38
MA03798-2	73	MAOHT14W5	76	MA4L310	47	MA5L460	47	MAPLP-600	92	TS4000T	38
MA03802-2	70	MA60042	48	MA4L320	47	MA5L470	47	MAPLP-750	92	TS7000T	38
MA04132-1	69	MA60048	48	MA4L330	47	MA5L480	47	MAPLP-1000	92	TS839T	38
MA04133-2	69	MA60049K	48	MA4L340	47	MA5L490	47	MAPLP-1500	92	VE14OD	20
MA04501-2	84	MA60306K	48	MA4L350	47	MA5L500	47	MAPLP-2000	92	VE38OD	20
MA04502-2	84	MA60325K	48	MA4L360	47	MA5L510	47	MAPLP-2500	92	VE12OD	20
MA04503-2	84	MA60350K	48	MA4L370	47	MA5L520	47	MAPLP-3000	92	VE58OD	20
MA04504-2	84	MA60378K	48	MA4L380	47	MA5L530	47	MAPLP-430E	92	VE34OD	20
MA04505-2	84	MA61000	48	MA4L390	47	MA5L540	47	MAPLP-640E	92	VE78OD	20
MA04506-2	84	MA61056	48	MA4L400	47	MA5L550	47	MAPLP-860E	92	VE118OD	20
MA04702-2B	71	MA68004	48	MA4L410	47	MA5L560	47	MAPLP-1290E	92	VE138OD	20
MA04704-2B	71	MA80105	48	MA4L420	47	MA5L570	47	MAPLP-1720E	92	VE158OD	20
MA04706-2B	71	MA80293	48	MA4L430	47	MA5L580	47	MAPLP-2150E	92	VE218OD	20
MA04708-2B	71	MA10602-1	69	MA4L440	47	MA5L590	47	MAPLP-2580E	92	VE258OD	20
MA04710-2B	71	MA10602-2	69	MA4L450	47	MA5L600	47	MASF-105	91	VE318OD	20
MA04712-2B	71	MA10602BX	69	MA4L460	47	MA5L610	47	MASF-135	91	VE358OD	20
MA048175-2	71	MA10604-1	69	MA4L470	47	MA5L620	47	MASF-175	91	VE418OD	20

AC/DC DIGITAL MULTI-METER WITH AUTO SELECTION

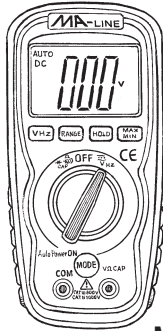

See
Page 2

MA-12837

ECONOMY AUTO-RANGING CLAMP-ON METER

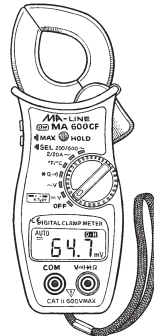

See
Page 4

MA-600CF

INFRARED THERMOMETER



See
Page 6

MA-16509A

WARRANTY – All products sold are warranted by MA-Line Division /Monti & Associates Inc. (Hereinafter MA-Line/Monti) only to Purchaser for resale or for use in business or original equipment manufacture, against defects in workmanship or materials under normal use for one year after date of purchase, except where the manufacturer's guarantee is for a shorter period, or unless otherwise stated. MA-Line/Monti's only obligation and Purchaser's only remedy is to replace the defective product, or refund the purchase price. All other warranties, express or implied, including but not limited to the implied warranties of merchantability and fitness for a particular purpose are specifically disclaimed. No warranty or affirmation of fact, express or implied, other than as set forth herein is made or authorized by MA-Line/Monti. MA-Line/Monti shall not be responsible for consequential, incidental, special, exemplary, or punitive damages. MA-Line/Monti's liability in all circumstances shall not exceed the purchase price paid for the product that gives rise to any liability. **MA-Line/Monti disclaims any liability for product claims that are due to product misuse, improper product selection, or misapplication. Any product description does not express or imply a warranty that the products are merchantable or fit for a particular purpose.** Illustrations and descriptions in this catalog are for the sole purpose of identification, and do not express or imply a warranty that the products are merchantable for a particular purpose, or that the products will conform to the illustrations or descriptions. MA-Line/Monti cannot be held responsible for typographical or photographic errors. MA-Line/Monti reserves the right to change the design, or materials of its products without notification, and if necessary, reserves the right to replace any product in catalog with another comparable product without notification. **MA-Line/Monti specifically disclaims any warranty to cover replacement labor costs, or any cost claim incidental the defective product, replacement, or reinstallation, or field repair expenses.** Different localities, states and nations have differing codes and regulations governing sales, construction, installation, and or use of products for certain purposes. While the MA-Line/Monti attempts to assure that its products are in compliance with such codes, it cannot be responsible for how the product is installed or used. Before purchasing the product, it is purchaser's responsibility to review the product application, and national and local code regulations, and be certain that the product, installation, and use of the product will comply with them.

TERMS AND CONDITIONS

MA-LINE ITEMS WILL NOT BE ACCEPTED BACK FOR CREDIT OR REPLACEMENT WITHOUT AN AUTHORIZED RETURN GOODS NUMBER ACCOMPANIED BY A MA-LINE INVOICE, PACKING SLIP. BEFORE CREDIT CAN BE ISSUED.

ALL DISCREPANCIES MUST BE REPORTED WITHIN 24 HOURS OF RECEIPT.

PRICING DISKS ARE AVAILABLE UPON REQUEST IN EITHER EXCEL OR ASCII FORMAT.

TOLL-FREE Customer Service Phone: 1-800-956-8220

TOLL-FREE Customer Service Fax: 1-800-336-8291

Phone: 1-847-956-8200 • Fax: 1-847-956-8237

International Phone: 001 (847) 956-8200 • International Fax: 001 (847) 956-8237

Customer service e-mail:

ksmith@ma-line.com • bcarlstrand@ma-line.com

Website: <http://www.ma-line.com>

**MA-LINE PRODUCTS and all PRODUCTS sold by MONTI & ASSOCIATES, INC.
are for PROFESSIONAL TRADESMEN ONLY.**



TOLL-FREE Customer Service
Phone: 1-800-956-8220
TOLL-FREE Customer Service
Fax: 1-800-336-8291
Phone: 1-847-956-8200
Fax: 1-847-956-8237

International Phone: 001 (847) 956-8200
International Fax: 001 (847) 956-8237
Customer service e-mail:
ksmith@ma-line.com
bcarlstrand@ma-line.com
Website: <http://www.ma-line.com>

MAILING ADDRESS: P.O. Box 866 • Arlington Heights, IL 60006-0866 USA
SHIPPING ADDRESS: 1050 E. Addison Court • Arlington Heights, IL 60005-4796 USA