

- ALL STEEL CONSTRUCTION
- INTEGRAL MULTI-SHUTTER DAMPER
- 1/2 INCH SPACED FINS SET AT 40 DEGREES
- MINIMUM SIZE = 8 X 4
- MAXIMUM SIZE = 20 X 6
- 1-WAY DEFLECTION
- FOR HEATING OR COOLING
- FINISH: WHITE (W) ENAMEL

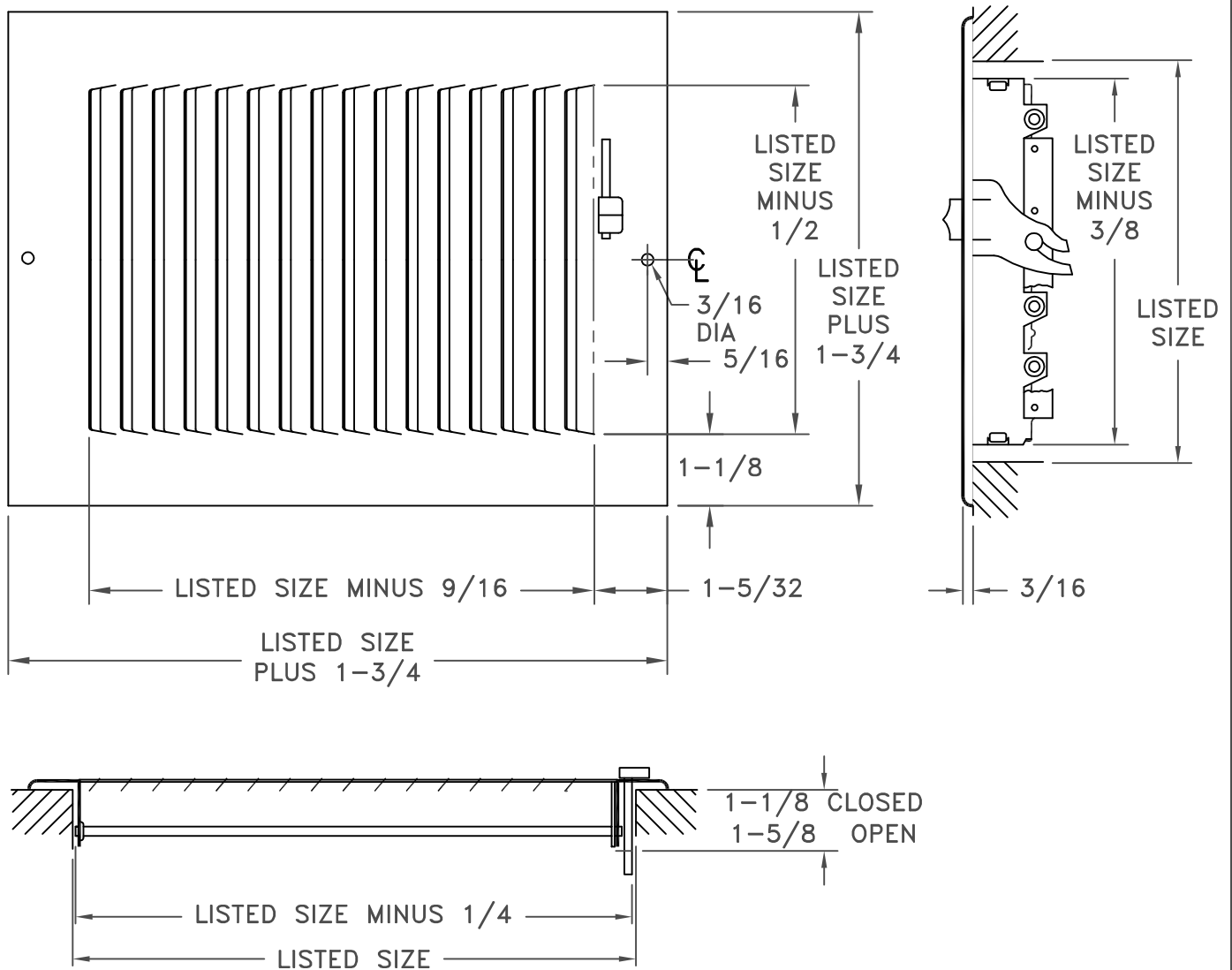

JOB NAME: _____	SUBMITTED BY: _____	DATE: 08/23/2013	SD-2435
LOCATION: _____		681	
ARCHITECT: _____		Steel 1-Way	
ENGINEER: _____		Ceiling Or Sidewall Register	
CONTRACTOR: _____			